

**MacDon™**

**Model FD70 FlexDraper®  
with  
CA20 Combine Adapter**

**UNLOADING and  
ASSEMBLY INSTRUCTIONS  
for  
NORTH AMERICAN SHIPMENTS**

## INTRODUCTION

This instructional manual describes the unloading, set-up and pre-delivery requirements for the MacDon FD70 FlexDraper with a CA20 Combine Adapter for North America.

The header may be delivered in either North American configuration or Export configuration.

Use the table of contents to guide you to specific areas.

Retain this instruction for future reference.

**CAREFULLY READ ALL THE MATERIAL PROVIDED BEFORE ATTEMPTING TO UNLOAD, ASSEMBLE, OR USE THE MACHINE.**

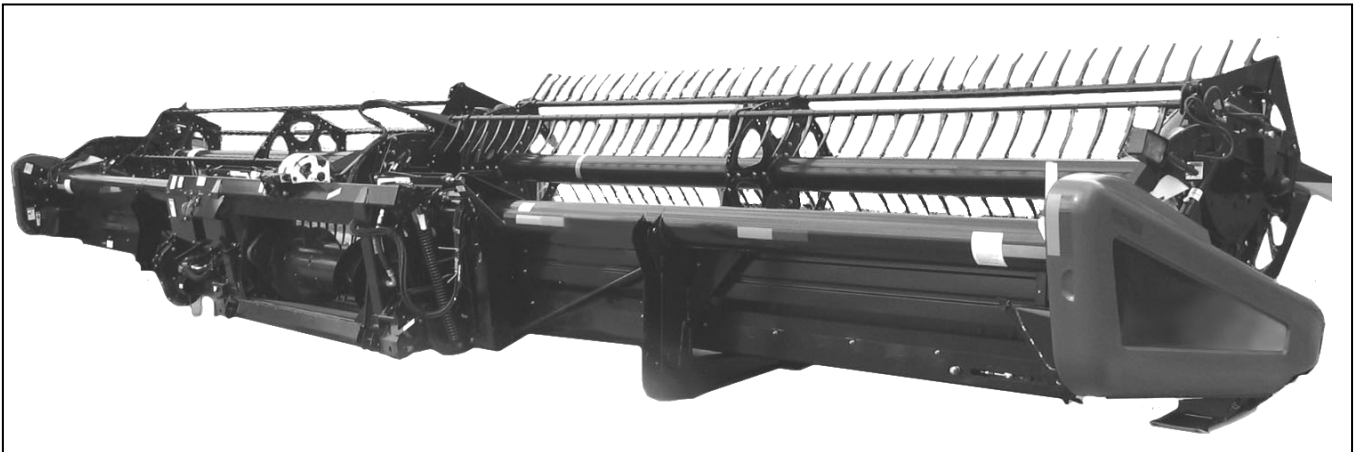

**MacDon FD70 FlexDraper with CA20 Combine Adapter**

## TABLE OF CONTENTS

<b>GENERAL SAFETY .....</b>	<b>3</b>
<b>RECOMMENDED TORQUES .....</b>	<b>5</b>
A. General .....	5
B. SAE Bolts .....	5
C. Metric Bolts .....	5
D. Hydraulic Fittings .....	6
<b>ENGLISH/METRIC EQUIVALENTS.....</b>	<b>7</b>
<b>SECTION I. UNLOADING .....</b>	<b>8</b>
A. Single Forklift Method .....	8
B. Combine Method .....	9
C. Two Forklift Method.....	10
<b>SECTION II. ASSEMBLY - NORTH AMERICA .....</b>	<b>11</b>
STEP 1. REPOSITION GEARBOX.....	11
STEP 2. INSTALL REEL SPEED SENSOR .....	12
A. Remove Cover .....	12
B. John Deere Series Sensor Installation.....	13
C. CAT Lexion 500 Series Sensor Installation.....	15
D. CAT Lexion 400 Series Sensor Installation.....	17
E. AGCO Sensor Installation .....	19
F. Install Cover .....	20
STEP 3. INSTALL OPTIONS .....	20
STEP 4. SET-UP ADAPTER.....	21
A. Filler Cap.....	21
B. Center-Link Kit .....	22
C. Flighting Extensions .....	22
D. Stripper Bars .....	22
E. CR Feeder Deflectors .....	23
STEP 5. ATTACH TO COMBINE.....	24
A. CASE IH.....	24
B. CASE IH 23, 25 Series.....	27
C. John Deere 60, 70 Series .....	30
D. John Deere 50 Series .....	32
E. CAT Lexion 400, 500 Series .....	34
F. New Holland CR, CX Series .....	38
G. AGCO.....	40
STEP 6. REMOVE SHIPPING SUPPORTS .....	43
STEP 7. POSITION TRANSPORT LIGHTS .....	43
STEP 8. INSTALL CROP DIVIDERS.....	44
STEP 9. TRIM DRAPER DEFLECTORS.....	44
STEP 10. INSTALL KNIFE HEAD SHIELDS .....	45
STEP 11. PRE-DELIVERY CHECKS .....	45
<b>SECTION III. ASSEMBLY - EXPORT .....</b>	<b>46</b>
STEP 1. INSTALL CENTER-LINK .....	46
STEP 2. REPOSITION GEARBOX.....	50
STEP 3. INSTALL FLOAT LINKS .....	51
STEP 4. INSTALL REEL SPEED SENSOR .....	52
STEP 5. INSTALL OPTIONS.....	52
STEP 6. ATTACH REEL LIFT CYLINDERS.....	53
STEP 7. ATTACH CAM ARMS.....	56
STEP 8. INSTALL REEL ENDSHIELDS.....	57
STEP 9. INSTALL CENTER FORE-AFT CYLINDER.....	59
STEP 10. SET-UP ADAPTER.....	59
STEP 11. ATTACH TO COMBINE.....	59
STEP 12. CONNECT FORE-AFT CYLINDERS .....	60
STEP 13. INSTALL CROP DIVIDERS.....	61
STEP 14. TRIM DRAPER DEFLECTORS.....	62
STEP 15. INSTALL KNIFE HEAD SHIELDS .....	62
STEP 16. POSITION TRANSPORT LIGHTS .....	62
STEP 17. PRE-DELIVERY CHECKS .....	62

<b>SECTION IV. PRE-DELIVERY CHECKS .....</b>	<b>63</b>
A. Tire Pressure - Slow Speed Transport and Stabilizer Wheel Options .....	63
B. Wheel Bolt Torque - Slow Speed Transport and Stabilizer Wheel Options .....	63
C. Wobble Box.....	63
D. Gearbox Oil.....	64
E. Hydraulic Reservoir.....	64
F. Sickle Belt Tension.....	65
G. Reel Centering .....	65
H. Draper Tension .....	66
I. Header Main Float.....	67
J. Trim Springs.....	69
K. Wing Float Lock Adjustment (Cutterbar Alignment).....	70
L. Wing Balance .....	71
M. Skid Shoe Settings.....	73
N. Reel Tine to Cutterbar Clearance .....	74
O. Draper Seal.....	75
P. Lubricate Header.....	76
Q. Endshields.....	79
R. Operator's Manual and Parts Catalogs.....	82
<b>SECTION V. HEADER RUN-UP .....</b>	<b>83</b>
STEP 1. RUN-UP THE HEADER.....	83
STEP 2. POST RUN-UP ADJUSTMENTS.....	85
A. Knife.....	85
B. Knife Speed.....	86

# GENERAL SAFETY



## CAUTION

- The following are general farm safety precautions that should be part of your operating procedure for all types of machinery.
- Protect yourself.

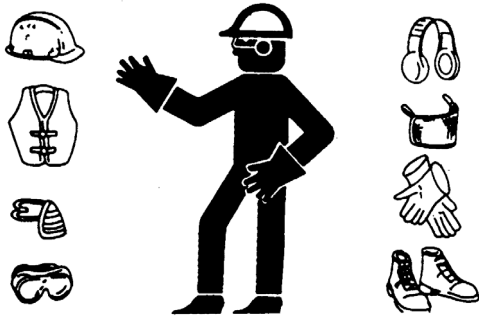

- When assembling, operating and servicing machinery, wear all the protective clothing and personal safety devices that COULD be necessary for the job at hand. Don't take chances.
- You may need:
  - a hard hat.
  - protective shoes with slip resistant soles.
  - protective glasses or goggles.
  - heavy gloves.
  - wet weather gear.
  - respirator or filter mask.
  - hearing protection. Be aware that prolonged exposure to loud noise can cause impairment or loss of hearing. Wearing a suitable hearing protective device such as ear muffs (A) or ear plugs (B) protects against objectionable or loud noises.

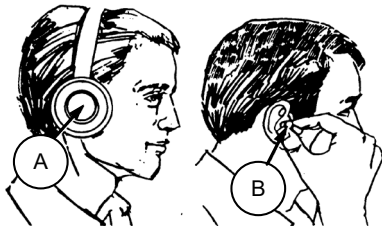

- Provide a first-aid kit for use in case of emergencies.
- Keep a fire extinguisher on the machine. Be sure the extinguisher is properly maintained and be familiar with its proper use.
- Keep young children away from machinery at all times.
- Be aware that accidents often happen when the operator is tired or in a hurry to get finished. Take the time to consider the safest way. Never ignore warning signs of fatigue.
- Wear close-fitting clothing and cover long hair. Never wear dangling items such as scarves or bracelets.
- Keep hands, feet, clothing and hair away from moving parts. Never attempt to clear obstructions or objects from a machine while the engine is running.

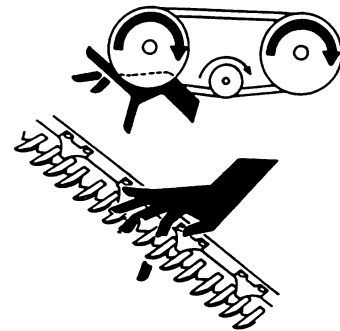

- Keep all shields in place. Never alter or remove safety equipment. Make sure driveline guards can rotate independently of the shaft and can telescope freely.

- Use only service and repair parts made or approved by the equipment manufacturer. Substituted parts may not meet strength, design, or safety requirements.
- Do not modify the machine. Unauthorized modifications may impair the function and/or safety and affect machine life.
- Stop engine and remove key from ignition before leaving operator's seat for any reason. A child or even a pet could engage an idling machine.



- Keep the area used for servicing machinery clean and dry. Wet or oily floors are slippery. Wet spots can be dangerous when working with electrical equipment. Be sure all electrical outlets and tools are properly grounded.
- Use adequate light for the job at hand.
- Keep machinery clean. Do not allow oil or grease to accumulate on service platforms, ladders or controls. Clean machines before storage.
- Never use gasoline, naphtha or any volatile material for cleaning purposes. These materials may be toxic and/or flammable.
- When storing machinery, cover sharp or extending components to prevent injury from accidental contact.

# RECOMMENDED TORQUES

## A. GENERAL

The tables shown below give correct torque values for various bolts and capscrews.

- Tighten all bolts to the torques specified in chart unless otherwise noted throughout this manual.
- Check tightness of bolts periodically, using bolt torque chart as a guide.
- Replace hardware with the same strength bolt.
- Torque figures are valid for non-greased or non-oiled threads and heads unless otherwise specified. Do not grease or oil bolts or capscrews unless specified in this manual.
- When using locking elements, increase torque values by 5%.

## B. SAE BOLTS

BOLT DIA. "A" (in.)	NC BOLT TORQUE			
	SAE 5		SAE 8	
	ft·lbf	N·m	ft·lbf	N·m
1/4	9	12	11	15
5/16	18	24	25	34
3/8	32	43	41	56
7/16	50	68	70	95
1/2	75	102	105	142
9/16	110	149	149	202
5/8	150	203	200	271
3/4	265	359	365	495
7/8	420	569	600	813
1	640	867	890	1205

\* Torque categories for bolts and capscrews are identified by their head markings.

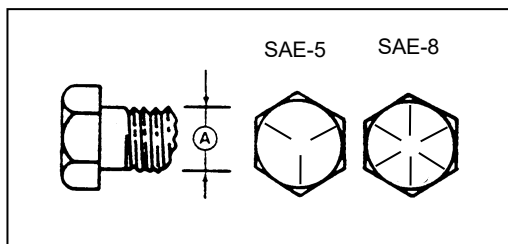

## C. METRIC BOLTS

BOLT DIA. "A"	NC BOLT TORQUE*			
	8.8		10.9	
	ft·lbf	N·m	ft·lbf	N·m
M3	0.4	0.5	1.3	1.8
M4	2.2	3	3.3	4.5
M5	4	6	7	9
M6	7	10	11	15
M8	18	25	26	35
M10	37	50	52	70
M12	66	90	92	125
M14	103	140	148	200
M16	166	225	229	310
M20	321	435	450	610
M24	553	750	774	1050
M30	1103	1495	1550	2100
M36	1917	2600	2710	3675

\* Torque categories for bolts and capscrews are identified by their head markings.

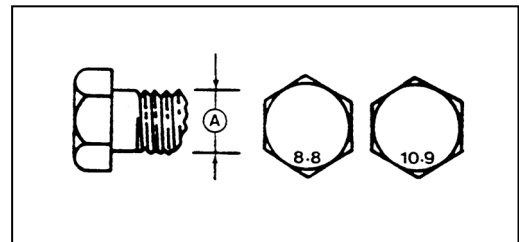

## D. HYDRAULIC FITTINGS

### FLARE TYPE

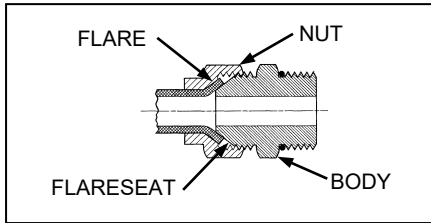

- Check flare and flare seat for defects that might cause leakage.
- Align tube with fitting before tightening.
- Lubricate connection and hand tighten swivel nut until snug.
- To prevent twisting the tube(s), use two wrenches. Place one wrench on the connector body, and with the second, tighten the swivel nut to the torque shown.

SAE NO.	TUBE SIZE O.D. (in.)	THD SIZE (in.)	NUT SIZE ACROSS FLATS (in.)	TORQUE VALUE*		RECOMMENDED TURNS TO TIGHTEN (AFTER FINGER TIGHTENING)	
				ft·lbf	N·m	Flats	Turns
3	3/16	3/8	7/16	6	8	1	1/6
4	1/4	7/16	9/16	9	12	1	1/6
5	5/16	1/2	5/8	12	16	1	1/6
6	3/8	9/16	11/16	18	24	1	1/6
8	1/2	3/4	7/8	34	46	1	1/6
10	5/8	7/8	1	46	62	1	1/6
12	3/4	1-1/16	1-1/4	75	102	3/4	1/8
14	7/8	1-3/8	1-3/8	90	122	3/4	1/8

\* The torque values shown are based on lubricated connections as in reassembly.

### O-RING TYPE

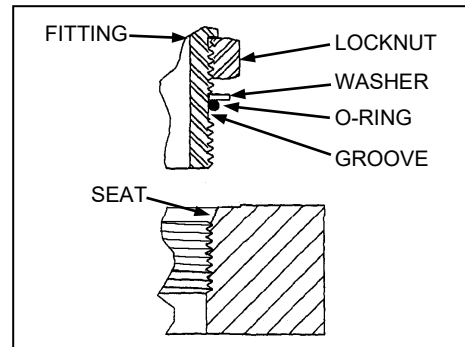

- Inspect O-ring and seat for dirt or obvious defects.

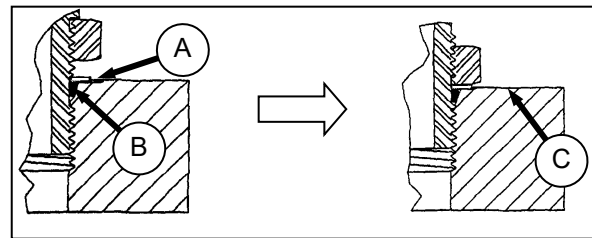

- On angle fittings, back off the lock nut until washer (A) bottoms out at top of groove (B) in fitting.
- Hand tighten fitting until back up washer (A) or washer face (if straight fitting) bottoms on part face (C) and O-ring is seated.
- Position angle fittings by unscrewing no more than one turn.
- Tighten straight fittings to torque shown.
- Tighten angle fittings to torque shown in the following table while holding body of fitting with a wrench.

SAE NO.	THD SIZE (in.)	NUT SIZE ACROSS FLATS (in.)	TORQUE VALUE*		RECOMMENDED TURNS TO TIGHTEN (AFTER FINGER TIGHTENING)	
			ft·lbf	N·m	Flats	Turns
3	3/8	1/2	6	8	2	1/3
4	7/16	9/16	9	12	2	1/3
5	1/2	5/8	12	16	2	1/3
6	9/16	11/16	18	24	2	1/3
8	3/4	7/8	34	46	2	1/3
10	7/8	1	46	62	1-1/2	1/4
12	1-1/16	1-1/4	75	102	1	1/6
14	1-3/16	1-3/8	90	122	1	1/6
16	1-5/16	1-1/2	105	142	3/4	1/8
20	1-5/8	1-7/8	140	190	3/4	1/8
24	1-7/8	2-1/8	160	217	1/2	1/12

\* The torque values shown are based on lubricated connections as in reassembly.



# ENGLISH/METRIC EQUIVALENTS

QUANTITY	INCH-POUND UNITS		FACTOR	SI UNITS (METRIC)	
	UNIT NAME	ABBR.		UNIT NAME	ABBR.
Area	acres	acres	$\times 0.4047 =$	hectares	ha
Flow	US gallons per minute	gpm	$\times 3.7854 =$	liters per minute	L/min
Force	pounds force	lbf	$\times 4.4482 =$	Newtons	N
Length	inch	in.	$\times 25.4 =$	millimeters	mm
	foot	ft	$\times 0.305 =$	meters	m
Power	horsepower	hp	$\times 0.7457 =$	kilowatts	kW
Pressure	pounds per square inch	psi	$\times 6.8948 =$	kilopascals	kPa
			$\times .00689 =$	megapascals	MPa
Torque	pound feet or foot pounds	lbf·ft or ft·lbf	$\times 1.3558 =$	newton meters	N·m
	pound inches or inch pounds	lbf·in. or in·lbf	$\times 0.1129 =$	newton meters	N·m
Temperature	degrees Fahrenheit	°F	$(^{\circ}\text{F} - 32) \times 0.56 =$	Celsius	°C
Velocity	feet per minute	ft/min	$\times 0.3048 =$	meters per minute	m/min
	feet per second	ft/s	$\times 0.3048 =$	meters per second	m/s
	miles per hour	mph	$\times 1.6063 =$	kilometers per hour	km/h
Volume	US gallons	US gal.	$\times 3.7854 =$	liters	L
	ounces	oz.	$\times 29.5735 =$	milliliters	ml
	cubic inches	in. <sup>3</sup>	$\times 16.3871 =$	cubic centimeters	cm <sup>3</sup> or cc
Weight	pounds	lb	$\times 0.4536 =$	kilograms	kg

## SECTION I. UNLOADING

### SECTION I. UNLOADING

#### A. SINGLE FORKLIFT METHOD



#### CAUTION

Equipment used for unloading must meet or exceed the requirements specified below. Using inadequate equipment may result in chain breakage, vehicle tipping or machine damage.

LIFTING VEHICLE	
Minimum Lifting Capacity	9000 lb (4082 kg) *
Minimum Fork Length	78 in. (1981 mm)

\* At 48 inches (1220 mm) from back end of forks.

#### IMPORTANT

Forklifts are normally rated for a load located 24 inches (610 mm) ahead of back end of the forks. To obtain the forklift capacity at 48 inches (1220 mm), check with your forklift distributor.



- Move trailer into position and block trailer wheels.
- Lower trailer storage stands.



#### CAUTION

To avoid injury to bystanders from being struck by machinery, do not allow persons to stand in unloading area.

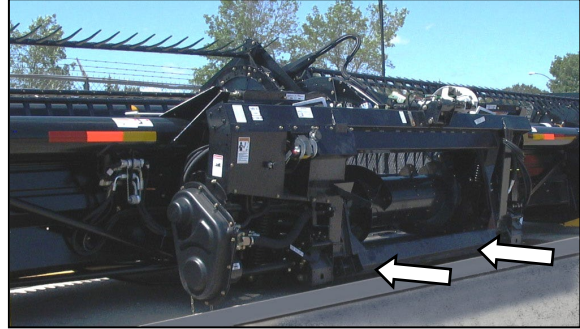

- Approach header from its backside, and slide forks in underneath adapter lower beam structure as far as possible.
- Remove hauler's tie down straps and chains.



#### WARNING

**Be sure forks are secure before moving away from load. Stand clear when lifting.**

- Raise windrower off deck.
- Back up until unit clears trailer, and slowly lower to 6 inches (150 mm) from ground.
- Take machine to storage or set-up area.
- Place 6 inch (150 mm) blocks under each end of cutterbar.
- Lower header onto blocks.
- Check for shipping damage and missing parts.

## SECTION I. UNLOADING

### B. COMBINE METHOD

The header is shipped with a fully assembled adapter and will have the necessary frame for attachment to the combine. Ensure the adapter configuration is identified and the appropriate combine is used to pick up the header.

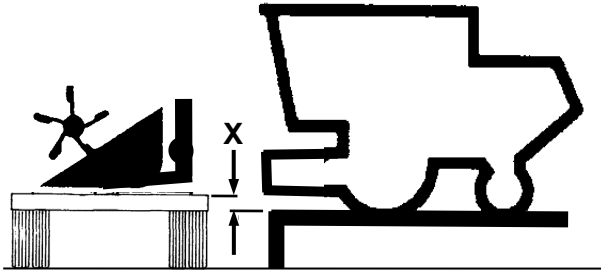

#### NOTE

*A maximum difference of 36 inches (914 mm) (dimension 'X' in illustration) in elevation between a standard or drop-deck truck flatbed and the combine is required for the combine to lift the header off the truck (i.e. using a loading ramp). This may vary with combine make and model.*

- a. Park the truck next to and at 90 degrees to the ramp, and with the rear of the header on the ramp side. Align the header pick up points approximately with the center of the ramp.
- b. Lower trailer storage stands.
- c. Remove hauler's tie-down straps and chains.
- d. Drive combine onto the ramp and approach header.

#### NOTE

*If a suitable ramp is not available, a ditch or other ground contour can provide the required difference in elevation.*

- e. Pick up header as would normally be done. Refer to **STEP 5. ATTACH TO COMBINE.**

#### NOTE

*The hydraulics and electrical connections are not required to unload the header.*

- f. Raise header off the flatbed and back combine away.
- g. Take machine to storage or set-up area.
- h. Place 6 inch (150 mm) blocks under each end of cutterbar.
- i. Lower header onto blocks.
- j. Detach header from combine.
- k. Check for shipping damage and missing parts.

## SECTION I. UNLOADING

### C. TWO FORKLIFT METHOD



#### CAUTION

Equipment used for unloading must meet or exceed the requirements specified below. Using inadequate equipment may result in chain breakage, vehicle tipping or machine damage.

<b>LIFTING VEHICLE</b>	
Minimum Lifting Capacity *	5000 lb (2268 kg)
Minimum Fork Length	78 in. (1981 mm)

\* At 48 inches (1220 mm) from back end of forks.

#### IMPORTANT

Forklifts are normally rated for a load located 24 inches (610 mm) ahead of back end of the forks.

To obtain the forklift capacity at 48 inches (1220 mm), check with your forklift distributor.



- Position trailer to provide access by forklifts on both sides.
- Approach header from both sides.

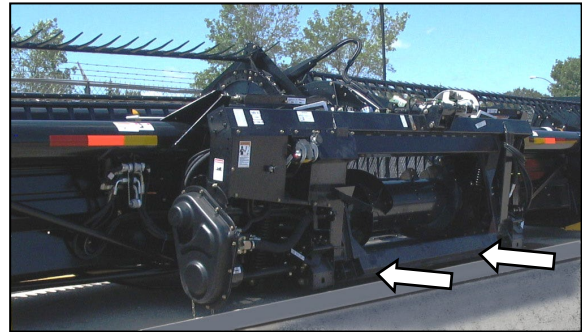

- Position forks underneath adapter lower beam structure with one forklift.

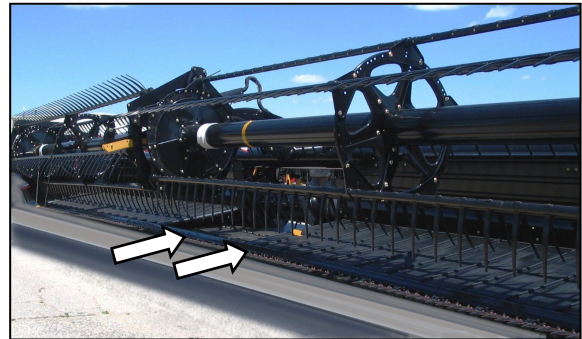

- Position forks underneath under cutterbar with other forklift.
- Remove hauler's tie down straps and chains.
- Slowly raise both forklifts until header clears trailer bed by 4 - 8 inches (102 - 204 mm).
- Slowly drive truck forward until trailer is clear of header.
- Place 6 inch (150 mm) blocks under each end of cutterbar.
- Lower header onto blocks.
- Back forklifts away from header.
- Check for shipping damage and missing parts.

## SECTION II. ASSEMBLY - NORTH AMERICA

### SECTION II. ASSEMBLY - NORTH AMERICA

#### IMPORTANT

If assembling a header shipped in EXPORT configuration, refer to SECTION III. ASSEMBLY - EXPORT.

#### STEP 1. REPOSITION GEARBOX

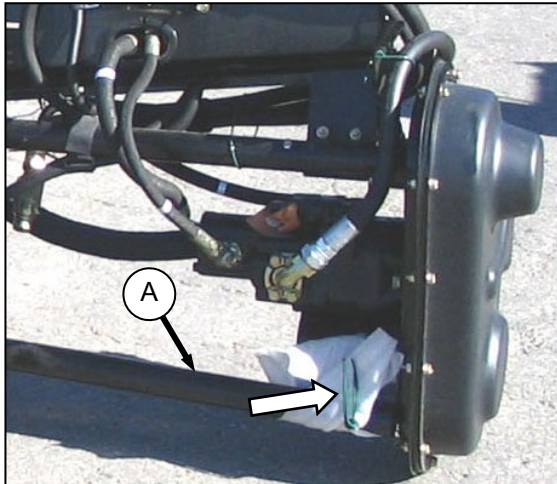

- a. Remove shipping wire and wrapping on brace



- and swing brace (A) clear of gearbox.  
b. Loosen nut (B) and move bolt out of shipping position slot.

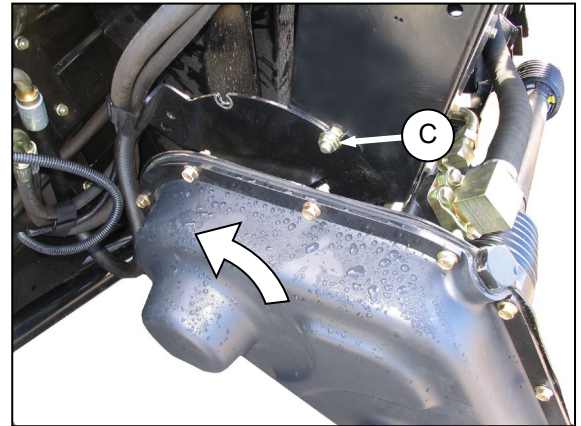

- c. Rotate gearbox and move bolt into working position slot (C). Tighten nut.  
d. Remove bolt and nut from bracket on gearbox.

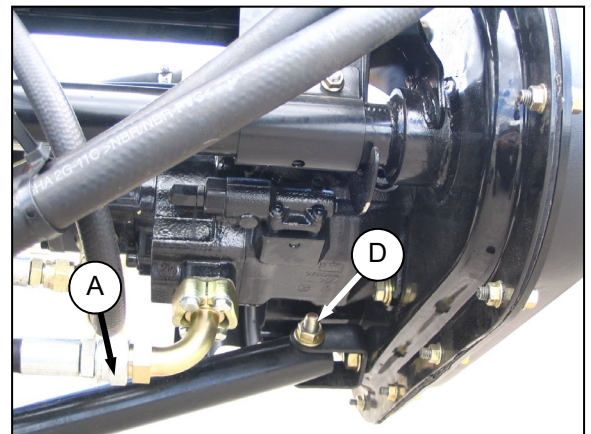

- e. Position brace (A) inside bracket and re-install bolt (D) and nut.

## SECTION II. ASSEMBLY - NORTH AMERICA

### STEP 2. INSTALL REEL SPEED SENSOR

**NOTE**

*This step is **not** applicable to CASE/CNH combines. Proceed to STEP 4. INSTALL OPTIONS.*

**IMPORTANT**

Except for Lexion combines, sensors are not supplied with MacDon Combine Adapters having Serial Numbers earlier than 177626\_07. Sensors need to be purchased as per the following:

COMBINE	SENSOR PART NO,
JOHN DEERE - ALL	John Deere #AH116104 & Two Nuts #H104418.
AGCO - ALL	AGCO #71 391 021



### CAUTION

To avoid personal injury, before servicing header or opening drive covers:

- Fully lower the header. If necessary to service in the raised position, always engage lift cylinder stops.
- Stop engine and remove key.
- Engage park brake.

#### A. REMOVE COVER

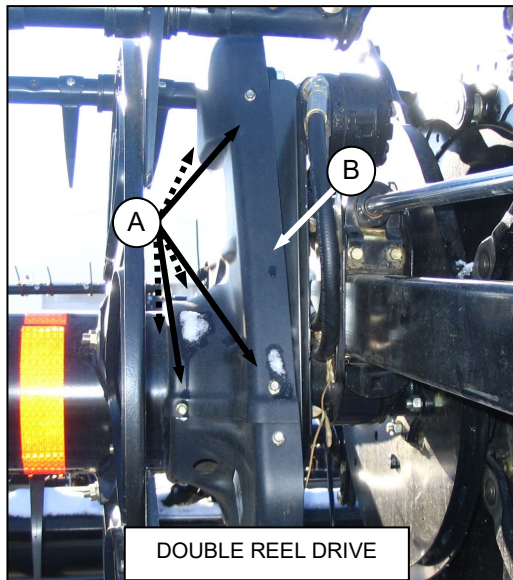

- a. Remove six screws (A) and remove drive upper cover (B).

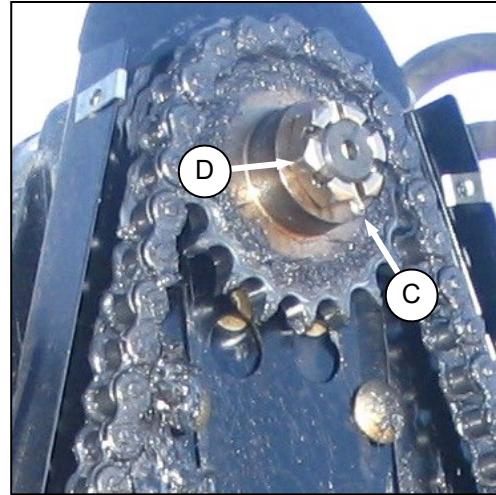

- b. Remove cotter pin (C) and remove slotted nut (D) from drive motor shaft.

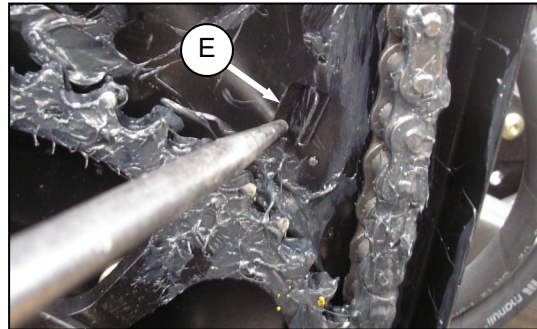

- c. Remove knock-out (E) in chain case for wire harness routing.

**NOTE**

*Clean off grease to expose knock-out.*

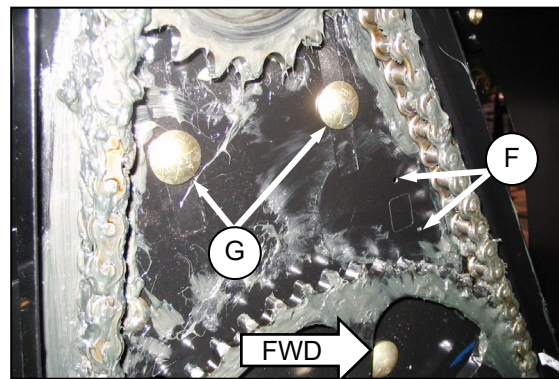

- d. If necessary, clean up holes (F) with a 0.125 in. (3.2 mm) drill.  
 e. Remove bolts (G) in chain case.

*(continued next page)*

## SECTION II. ASSEMBLY - NORTH AMERICA

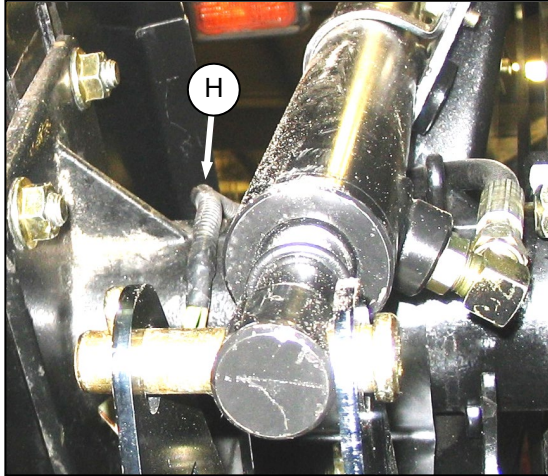

- f. Retrieve existing harness (H) from reel arm.

### NOTE

*Harness may be stored inside hose cover on top of reel arm.*

*Proceed to procedure B, C, D or E depending on your particular combine.*

### B. JOHN DEERE SERIES SENSOR INSTALLATION

- a. Perform A. REMOVE COVER.
- b. Retrieve speed sensor kit from combine completion package.

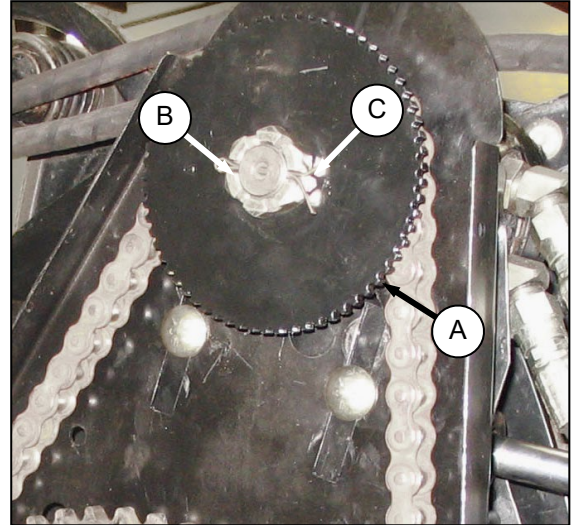

- c. Position speed sensor disc (A) on shaft and re-install slotted nut (B). Torque to 10 - 20 in·lbf (1.1 - 2.2 N·m).
- d. Install cotter pin (C). Tighten nut to next slot if required.

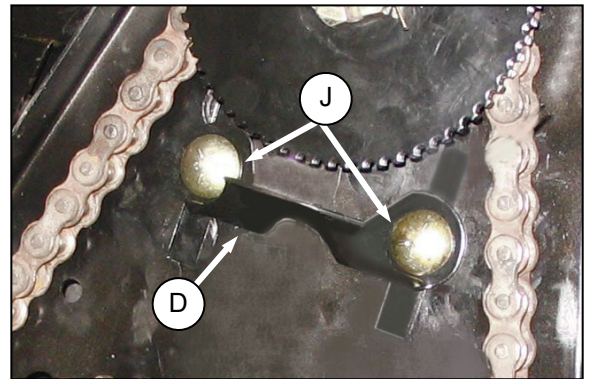

- e. Locate bracket (D) on chain case and re-install bolts (J). Torque to 75 ft·lbf (102 N·m).

*(continued next page)*

## SECTION II. ASSEMBLY - NORTH AMERICA

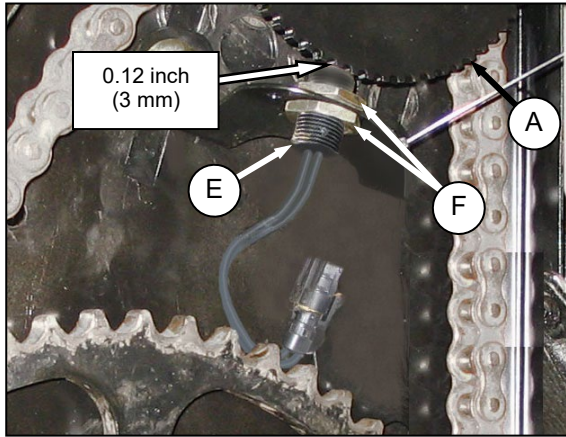

- f. Locate sensor (E) in bracket and adjust gap between sensor and disc (A) to 0.12 in. (3 mm) with nuts (F). Tighten nuts.

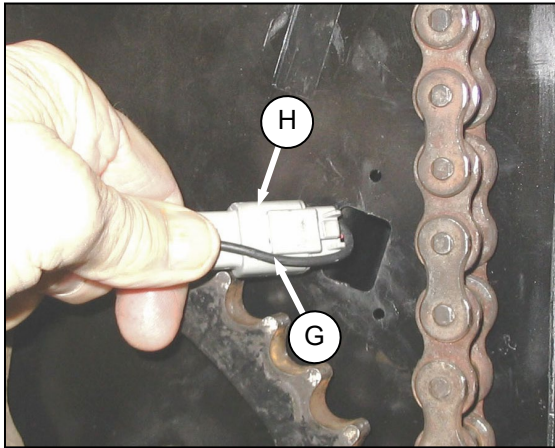

- g. Locate black wire (G) against harness connector (H) as shown and feed connector through hole in chain case.

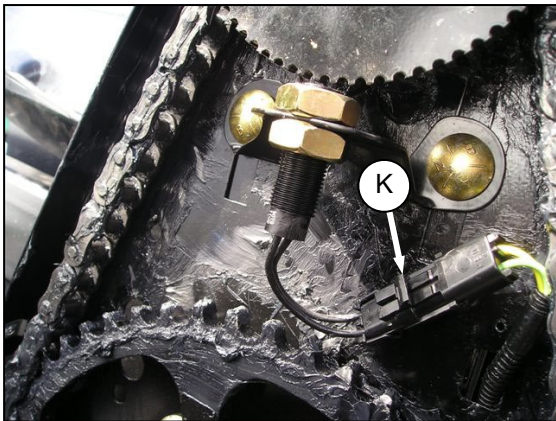

- h. Connect other end to sensor connector (K).  
i. Secure harness to support (D) with two cable ties (L).

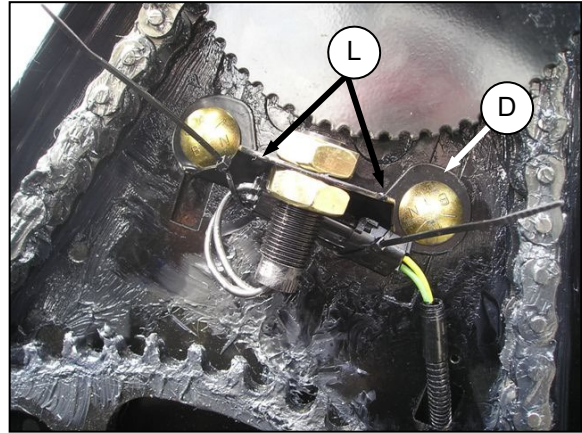

### IMPORTANT

Ensure harness is clear of chain and sprockets, and that motor can be moved up and down fully in slots without damaging harness.

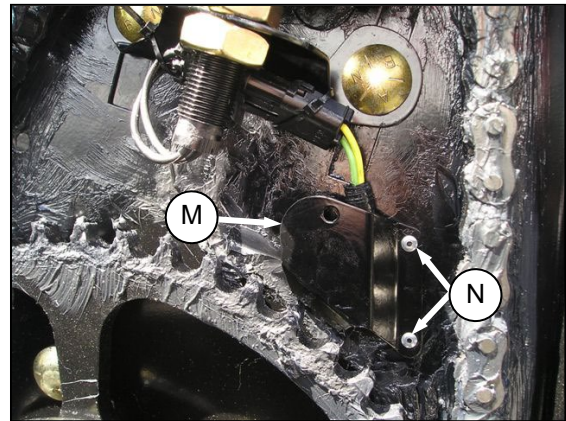

- j. Locate cover (M) over harness and attach to chain case with two rivets (N).  
k. Perform F. INSTALL COVER.



## SECTION II. ASSEMBLY - NORTH AMERICA

### C. CAT LEXION 500 SERIES SENSOR INSTALLATION

- a. Perform **A. REMOVE COVER.**
- b. Retrieve speed sensor kit from combine completion package.

#### IMPORTANT

The following steps c. and d. are required to establish the amount of slack in the harness, and to determine the harness location on the cover, so that when the chain (A) is loosened, the harness or sensor will not be damaged.

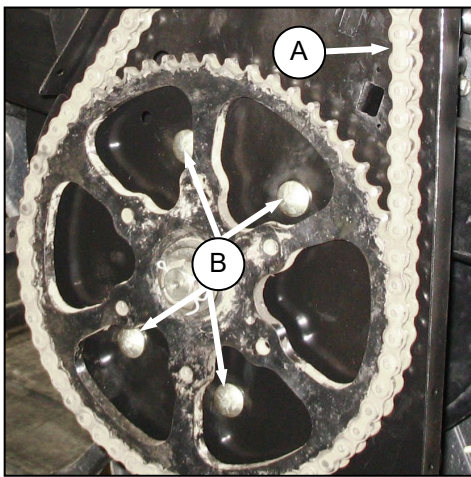

- c. Loosen four bolts (B)

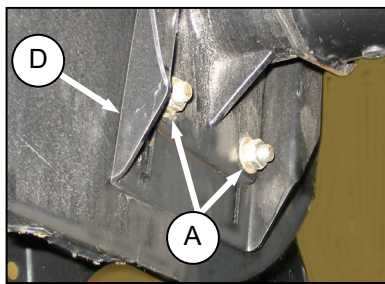
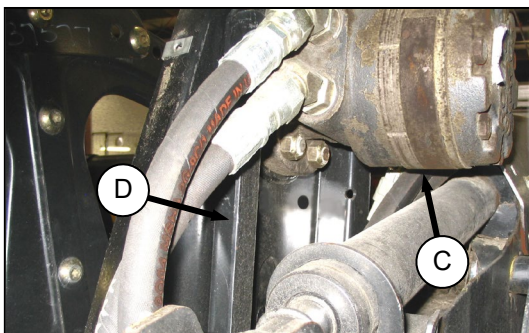

- d. Loosen drive chain (A) by sliding motor (C) and motor mount (D) down towards reel shaft.

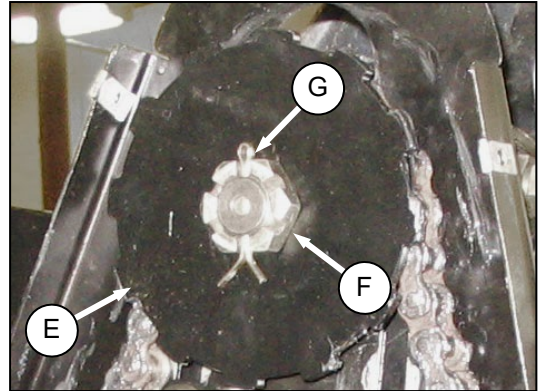

- e. Position speed sensor disc (E) on shaft and re-install slotted nut (F). Torque to 10 - 20 in·lbf (1.1 - 2.2 N·m).
- f. Install cotter pin (G). Tighten nut to next slot if required.

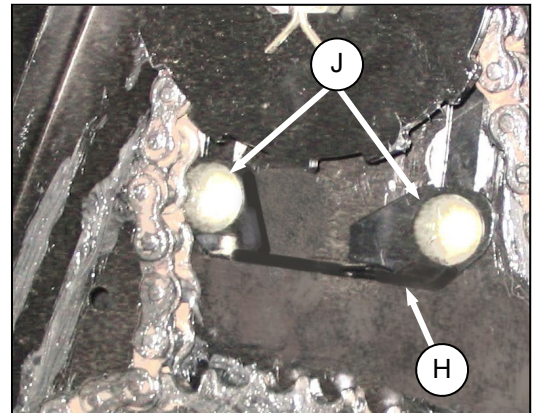

- g. Locate support (H) on chain case and re-install bolts (J). Torque to 75 ft·lbf (102 N·m).

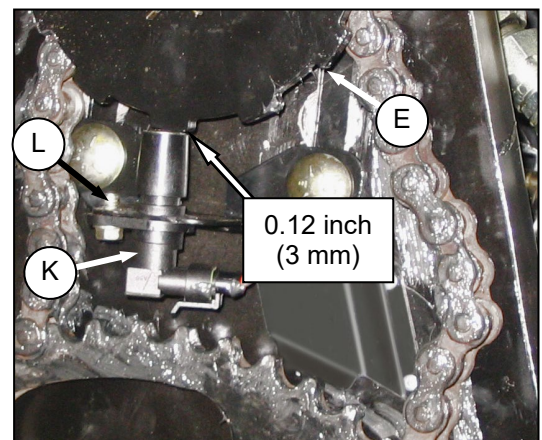

- h. Locate sensor (K) in support (H) and adjust gap between sensor and disc (E) to 0.12 inch (3 mm) by bending support. After gap is achieved, secure sensor with 1/4" x 0.5 self-tapping screw (L).

(continued next page)

## SECTION II. ASSEMBLY - NORTH AMERICA

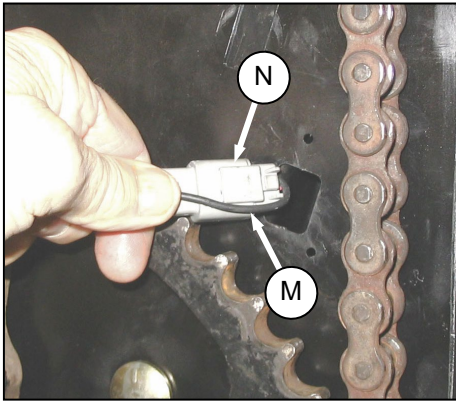

- i. Locate black wire (M) against harness connector (N) as shown and feed connector through hole in chain case.

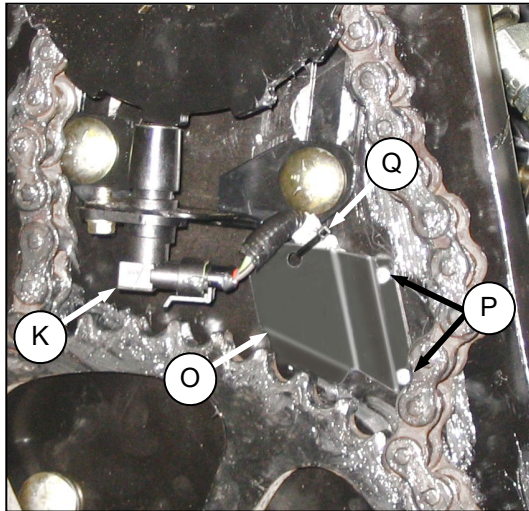

- j. Connect other end to sensor (K).  
 k. Locate cover (O) over harness and attach to chain case with two rivets (P).  
 l. Secure harness to cover (O) with cable tie (Q) exactly as shown.

### IMPORTANT

Ensure harness is clear of chain and sprockets, and that motor can be moved up and down fully in slots without damaging harness.

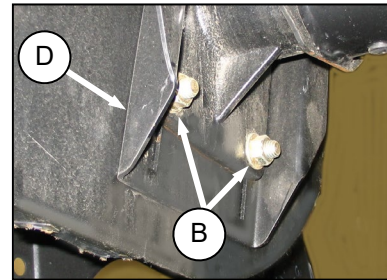
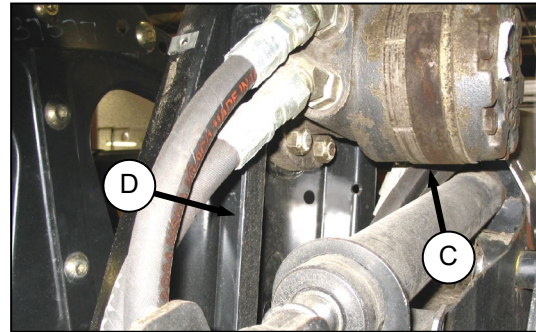

- m. Tighten drive chain by sliding motor (C) and motor mount (D) up away from reel shaft. Hand force should deflect the chain 1/8 inch (3 mm).

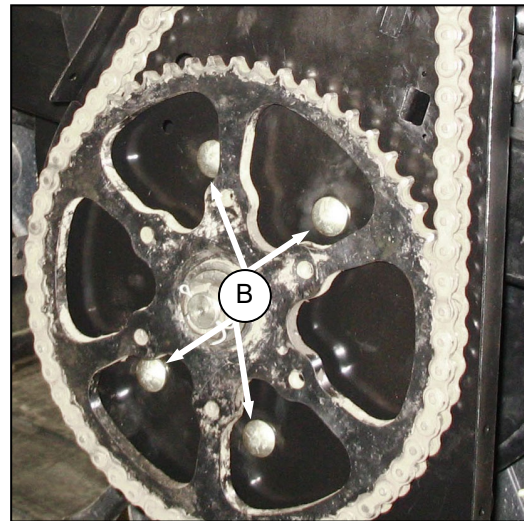

- n. Tighten bolts (B) to 75 ft·lbf (102 N·m).  
 o. Perform **F. INSTALL COVER.**

## SECTION II. ASSEMBLY - NORTH AMERICA

### D. CAT LEXION 400 SERIES SENSOR INSTALLATION

- Perform **A. REMOVE COVER.**
- Retrieve speed sensor kit from combine completion package.

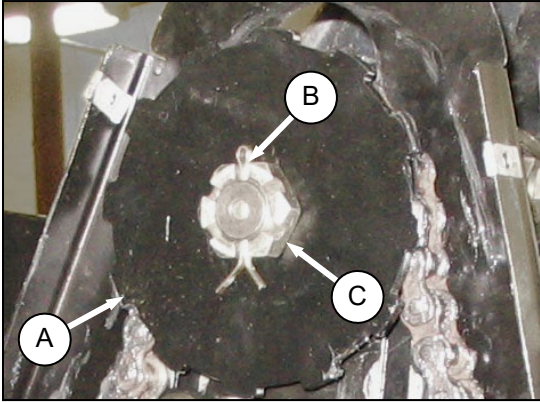

- Position speed sensor disc (A) on shaft and re-install slotted nut (B). Torque to 10 - 20 in·lbf (1.1 - 2.2 N·m).
- Install cotter pin (C). Tighten nut to next slot if required.

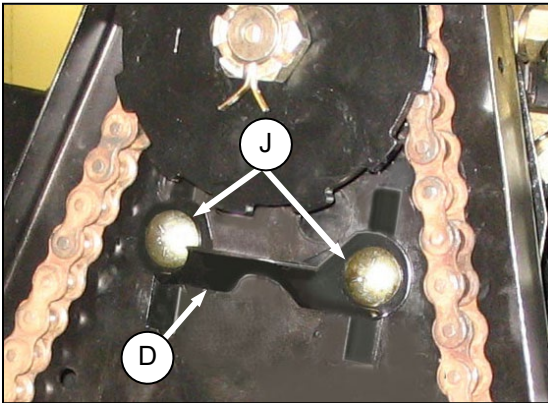

- Locate bracket (D) on chain case and re-install bolts (J). Torque to 75 ft·lbf (102 N·m).

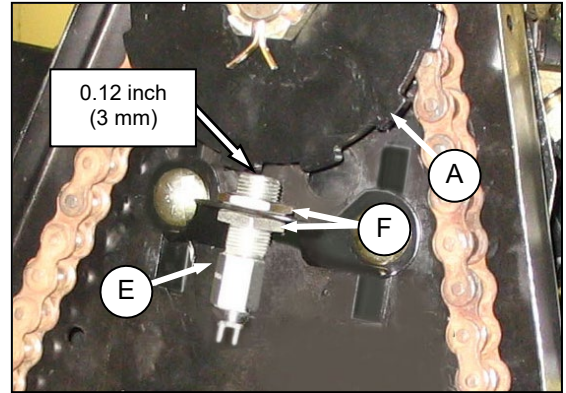

- Locate sensor (E) in bracket and adjust gap between sensor and disc (A) to 0.12 inch (3 mm) with nuts (F). Tighten nuts.

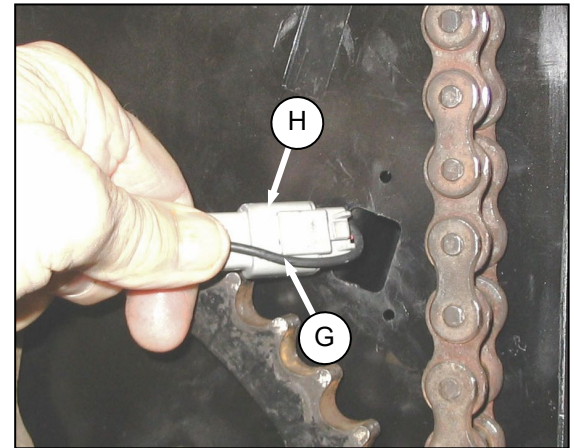

- Locate black wire (G) against harness connector (H) as shown and feed connector through hole in chain case.

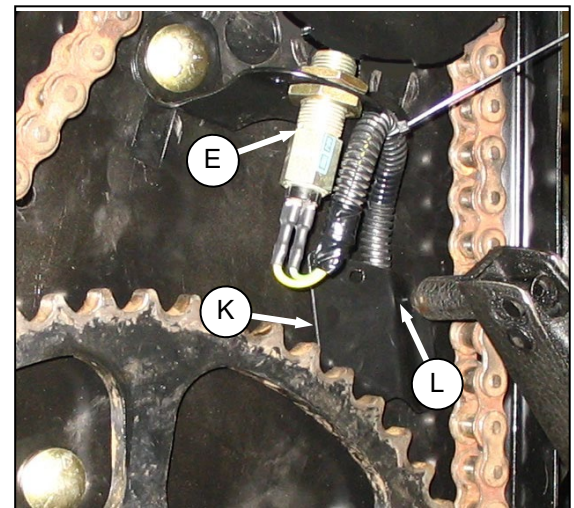

- Connect other end to sensor (E).
- Locate cover (K) over harness and attach to chain case with two rivets (L).

*(continued next page)*

## SECTION II. ASSEMBLY - NORTH AMERICA

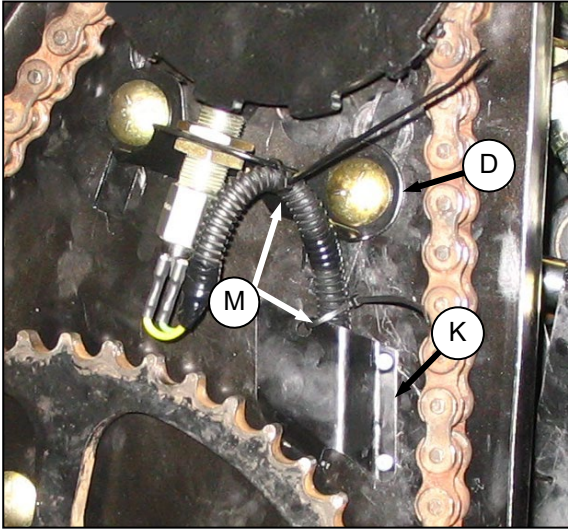

- j. Secure harness to support (D) and cover (K) with cable ties (M).

### **IMPORTANT**

Ensure harness is clear of chain and sprockets, and that motor can be moved up and down fully in slots without damaging harness.

- k. Perform **F. INSTALL COVER.**

## SECTION II. ASSEMBLY - NORTH AMERICA

### E. AGCO SENSOR INSTALLATION

- Perform **A. REMOVE COVER**.
- Retrieve speed sensor kit from combine completion package.

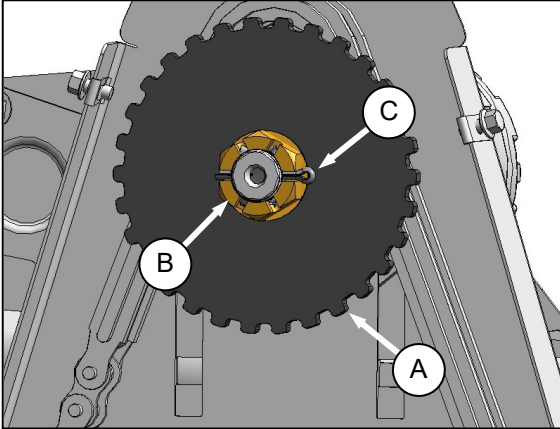

- Position speed sensor disc (A) on shaft and re-install slotted nut (B). Torque to 10 - 20 in·lbf (1.1 - 2.2 N·m).
- Install cotter pin (C). Tighten nut to next slot if required.

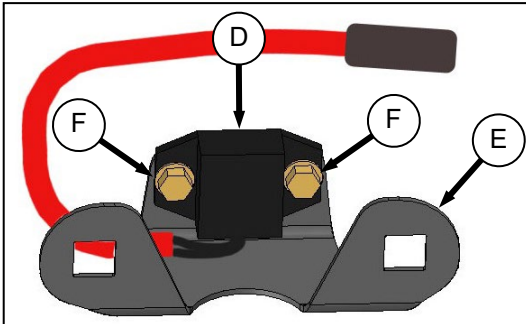

- Assemble sensor (D) to support (E) with self-tapping screws (F).

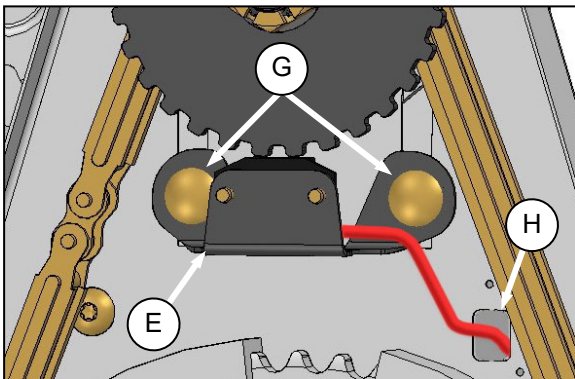

- Locate support (E) on chain case and re-install bolts (G). Torque to 75 ft·lbf (102 N·m).

- Route connector end of sensor harness through hole (H) in drive case as shown.

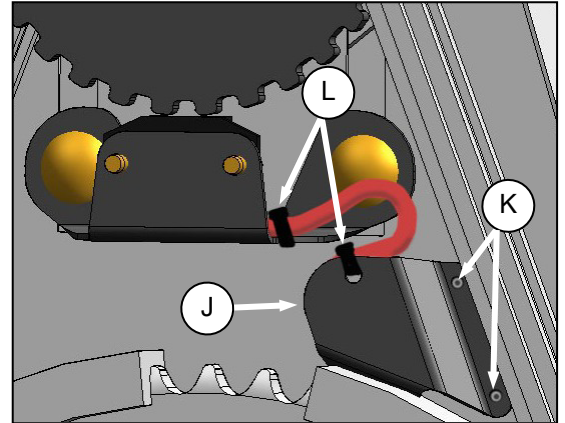

- Locate cover (J) over harness and attach to chain case with two rivets (K).
- Secure harness to cover (K) and support with cable ties (L) exactly as shown.

#### IMPORTANT

Ensure harness is clear of chain and sprockets, and that motor can be moved up and down fully in slots without damaging harness.

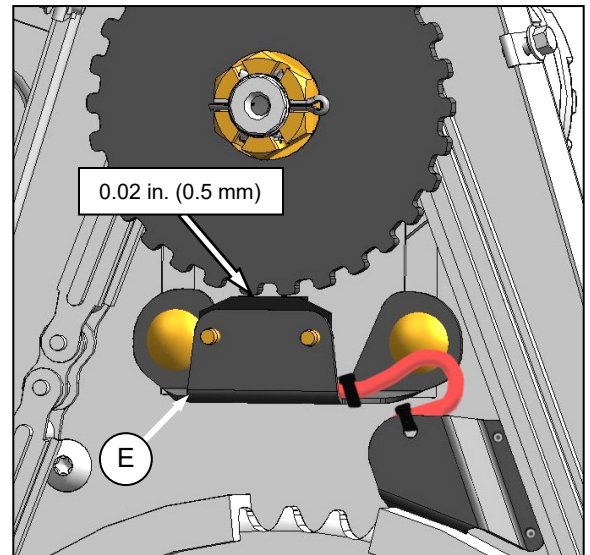

- Adjust gap between sensor and disc to 0.02 inch (0.5 mm) by bending support (E).

## SECTION II. ASSEMBLY - NORTH AMERICA

### F. INSTALL COVER

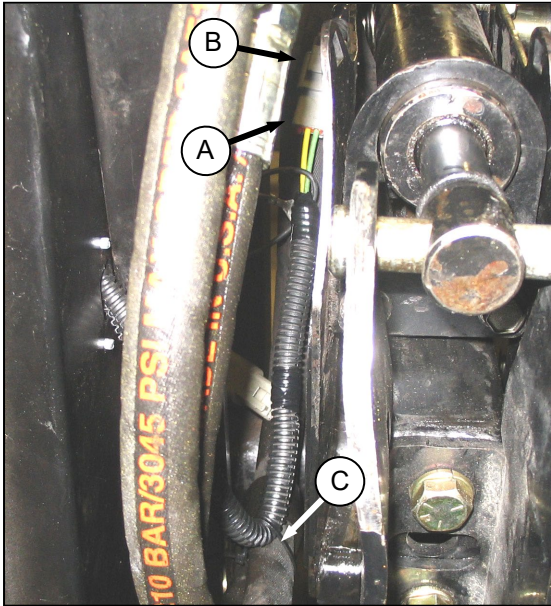

- a. Attach sensor connector (A) to existing harness (B) behind chain case.
- b. Secure sensor harness to hose with cable tie (C).

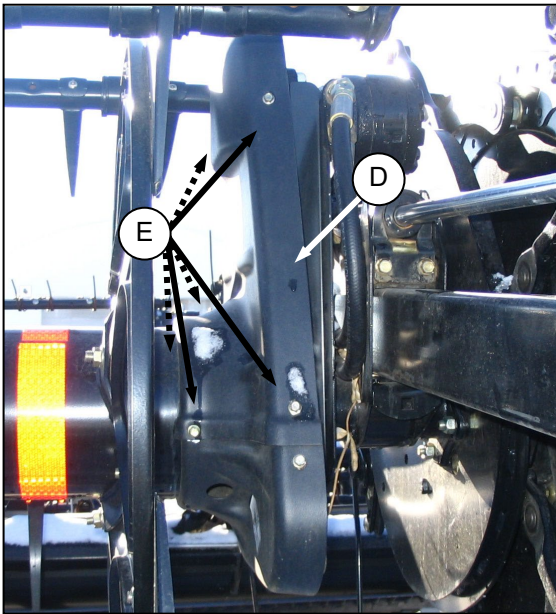

- c. Position cover (D), and install six screws (E).

### STEP 3. INSTALL OPTIONS

Retrieve kits supplied as options with the header, and install in accordance with installation instructions supplied in each kit.

## SECTION II. ASSEMBLY - NORTH AMERICA

### STEP 4. SET-UP ADAPTER

#### A. FILLER CAP

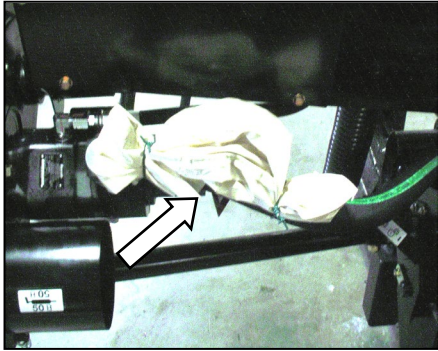

- a. Remove filler cap from bag.

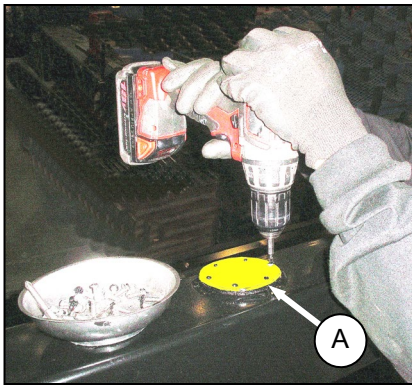

- b. Remove yellow shipping cover (A) from adapter frame. Discard cover and keep screws.



### CAUTION

Cap may be under pressure. Allow pressure to equalize by lifting cap slightly with some of the screws remaining.

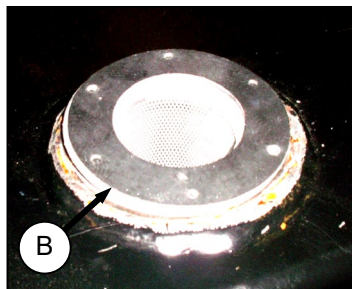

- c. There are two gaskets - one on either side of the filler strainer flange. Remove the top gasket (B) for use in step d.



- d. Place gasket (B) that was removed from the top of the filler strainer onto filler cap neck, and align holes.
- e. Install #10-32 screws on filler cap, pressing screws through the gasket.
- f. Apply Loctite® #565 (or equivalent) to screws.
- g. Place filler cap (complete with screws) over opening, aligning the machine screws with the threaded holes.

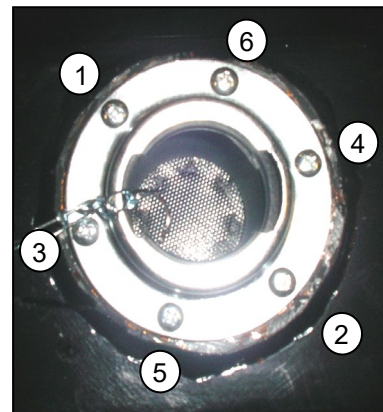

- h. Carefully thread in the machine screws using a cross pattern (see photo) to prevent cross threading of tapped holes.
- i. Repeat pattern to gradually tighten screws to 31 lbf-in. (3.5 N·m).



- j. Install filler cap.

## SECTION II. ASSEMBLY - NORTH AMERICA

### B. CENTER-LINK KIT

Some combine models require shorter center-link components to ensure clearance to the combine cab. To avoid damage to your combine, lift feeder slowly and check clearance between cab and header center-link. If clearance is inadequate, order short center-link components. Installation instructions are included.

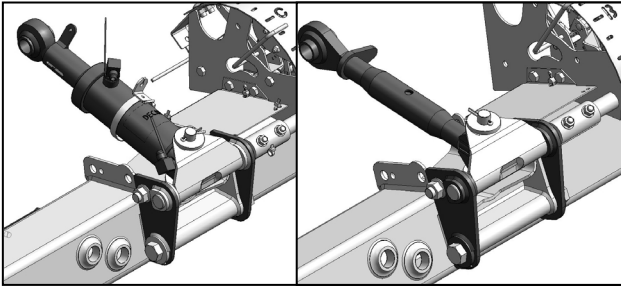

SHORT CENTER-LINK ASSEMBLIES

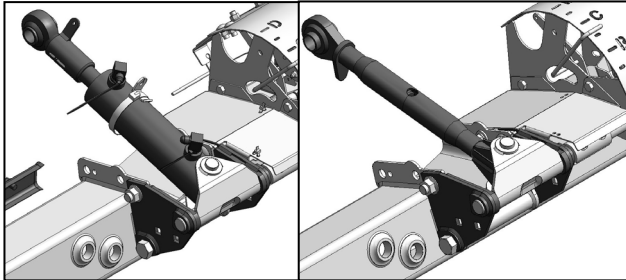

TYPICAL CENTER-LINK ASSEMBLIES

The following combine models have been identified for requiring the shorter center-link components:

- Case IH 5088, 6088, and 7088 without Stone Traps.
- Gleaner R Series.

Contact your MacDon distributor for ordering information.

### C. FLIGHTING EXTENSIONS

Flighting extension kits may have been supplied with your header to improve feeding in certain crops such as rice. They are not recommended in cereal crops.

**APPLICABLE COMBINES: All except New Holland CR960, 9060, 970, 9070, and 9080.**

If necessary, remove auger flighting extensions as follows.

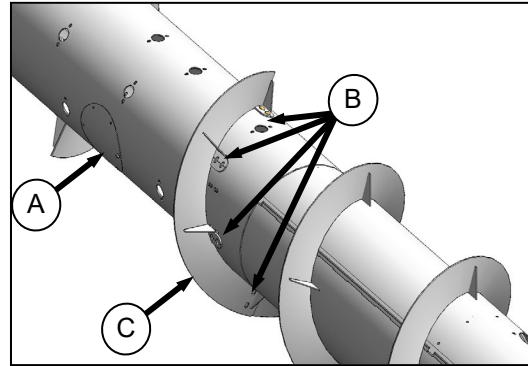

- Remove access cover (A).
- Remove eight bolts (B), washers, and nuts that secure flighting extension (C) to auger and remove extension.
- Repeat for other flighting extension.
- Re-install access cover (A).

### D. STRIPPER BARS

Stripper bar kits may have been supplied with your header to improve feeding in certain crops such as rice. They are not recommended in cereal crops.

**APPLICABLE COMBINES: All except New Holland CR960, 9060, 970, 9070, and 9080.**

If necessary, remove auger stripper bars as follows:

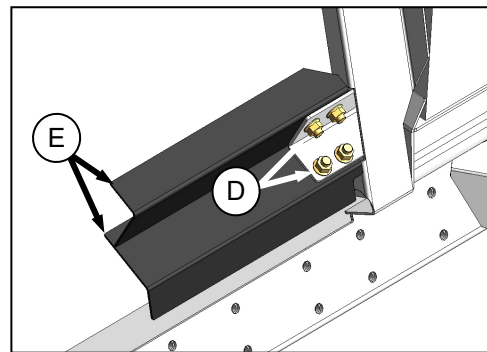

- Remove four bolts (D) and nuts securing bars (E) to adapter frame and remove bars.
- Repeat for opposite set of stripper bars.



## SECTION II. ASSEMBLY - NORTH AMERICA

### E. CR FEEDER DEFLECTORS

For New Holland CR 960, 9070, and 9080 combines, feeder kits have been installed on the adapter at the factory to improve feeding into the feeder house. They may also have been installed as an option on older machines. If necessary, they can be removed.

CA20 adapters for the CR Models listed have short feeder kits installed at the factory. Long feeder kits are provided for narrow feeder house combines and are dealer installed to replace the short feeder kits.

COMBINE MODEL	FEEDER HOUSE SIZE	FEEDER KIT SIZE
CR970, 9070, 9080	Wide	Short - 200 mm
CR960, 9060, 940, 9040	Narrow	Long - 325 mm

If required, replace the feeder deflectors as follows:

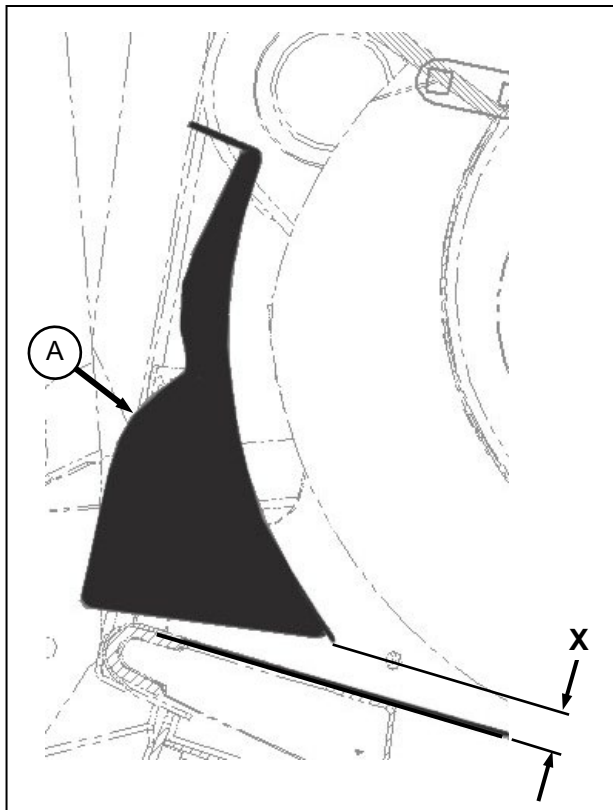

- Determine position of existing deflector (A) by measuring gap "X" between deflector forward edge and pan.

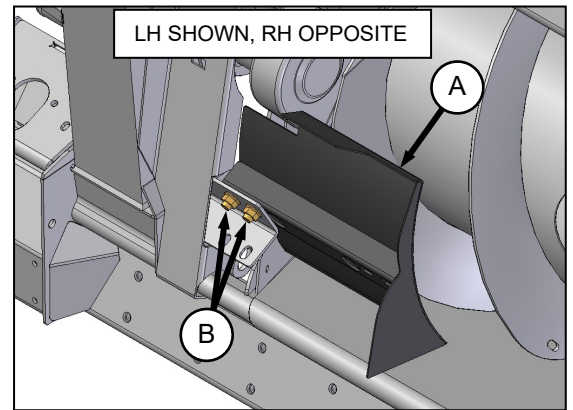

- Remove two bolts (B) and nuts securing deflector (A) to adapter frame and remove deflector.
- Position replacement deflector and secure with bolts (B) and nuts. Maintain dimension "X" from existing deflector for replacement deflector.
- Repeat for opposite deflector.
- After attaching header to combine, extend center-link fully and check gap between deflector and pan. Maintain 7/8 in. (22 mm) +/- 1/8 in. (3 mm).

## SECTION II. ASSEMBLY - NORTH AMERICA

### STEP 5. ATTACH TO COMBINE

Refer to specific section for your combine.

COMBINE	SECTION
CASE IH	A
CASE IH 23, 25 SERIES	B
JD 60, 70 SERIES	C
JOHN DEERE 50 SERIES	D
LEXION	E
NEW HOLLAND	F
AGCO	G

#### IMPORTANT

Ensure applicable functions (AHHC, Draper Header Option, Hydraulic Center-link Option, Hydraulic Reel Drive, etc.) are enabled on the combine and combine computer. Failure to do so may result in improper header operation.

#### IMPORTANT

Some combine models require shorter center-link components to ensure clearance to the combine cab.

To avoid damage to your combine, lift feeder slowly and check clearance between cab and header center-link. If clearance is inadequate, order short center-link components. Installation instructions are included. See **STEP 4 SET-UP ADAPTER**.

### A. CASE IH

Case IH 7010, 8010, 7120, 8120, 5088, 6088, 7088

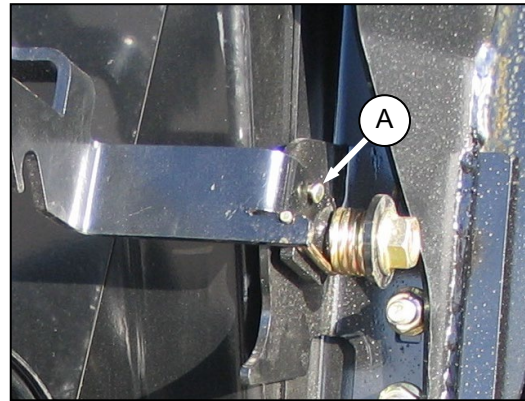

- Remove shipping pin (A). Retain pin for future installation.

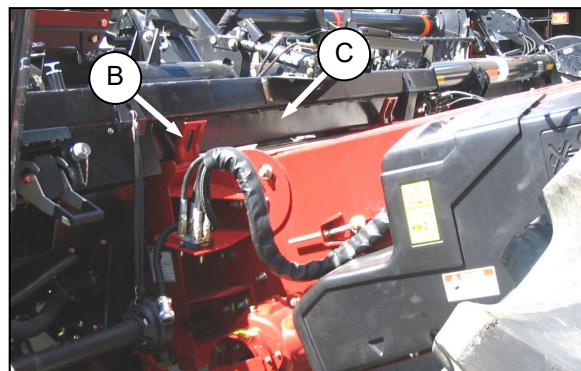

- Slowly drive combine up to header until feeder house saddle (B) is directly under the adapter top cross member (C).
- Raise feeder house to lift header slightly, ensuring feeder saddle is properly engaged in adapter frame.

*(continued next page)*

## SECTION II. ASSEMBLY - NORTH AMERICA



### CAUTION

Stop engine and remove key from ignition before leaving operator's seat for any reason. A child or even a pet could engage an idling machine.

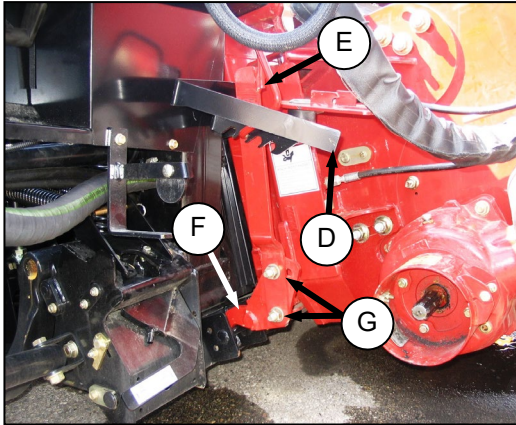

- d. Lift latch (D) on adapter at left side of feeder house and push handle (E) on combine to engage locks (F) on both sides of the feeder house.
- e. Push down on latch (D) so that slot in latch engages handle (E) to lock it in place.
- f. If lock (F) does not fully engage pin on adapter when latch (D) and handle (E) are engaged, loosen bolts (G) and adjust lock as required. Retighten bolts.
- g. Remove blocks from under cutterbar.
- h. Start engine and lower header. Shutdown combine.
- i. Connect combine hydraulic quick coupler to receptacle on adapter as follows:

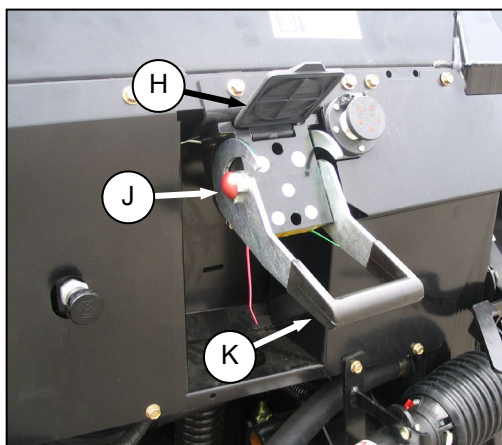

1. Open cover (H).
2. Push in lock button (J) and pull handle (K) to position approximately as shown.

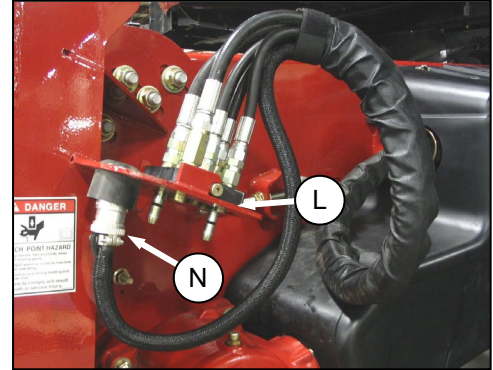

3. Remove coupler (L) from combine and clean coupler.

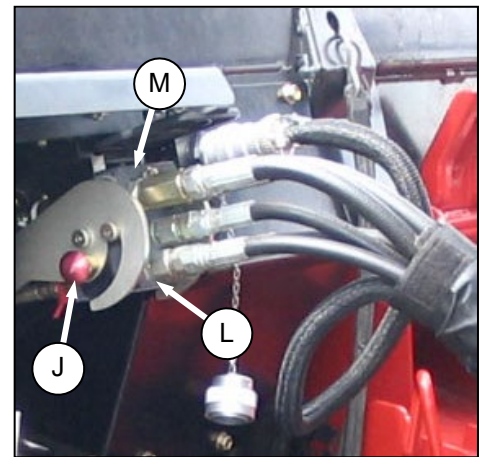

4. Position coupler (L) onto adapter receptacle (M) and push handle to engage coupler pins into receptacle.
5. Push handle to closed position until lock button (J) snaps out.
- j. Remove electrical connector (N) from storage cup on combine.

*(continued next page)*

## SECTION II. ASSEMBLY - NORTH AMERICA

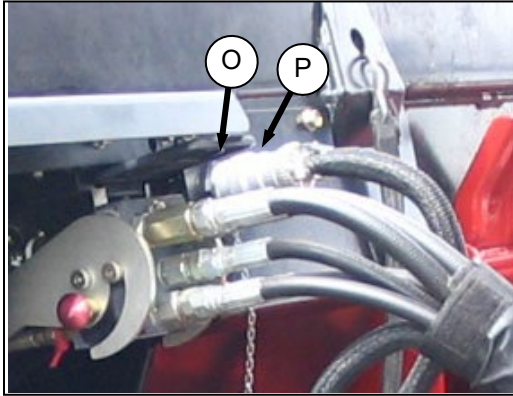

- k. Open cover on adapter electrical receptacle (O), align lugs on connector (P) with slots in adapter receptacle, push connector onto receptacle and turn collar on connector to lock it in place.

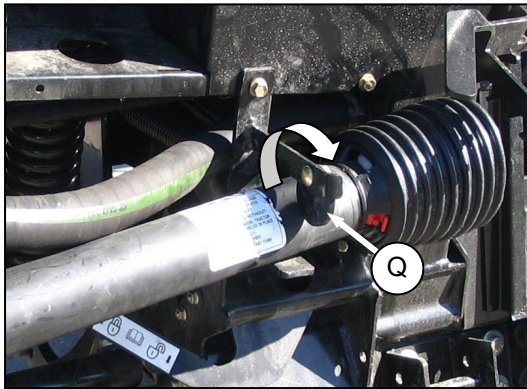

- l. Rotate disc (Q) on adapter driveline storage hook and remove driveline from hook.

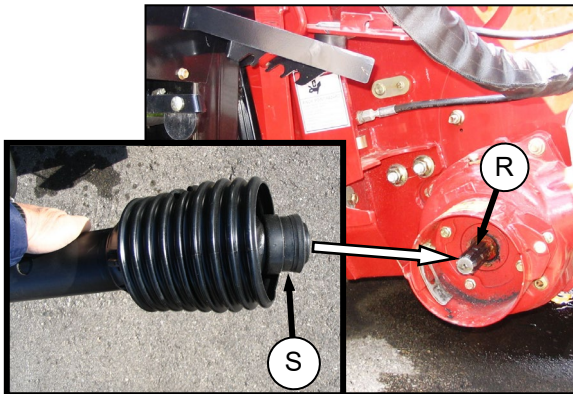

- m. Pull back collar (R) on end of driveline and push onto combine output shaft (S) until collar locks.
- n. Proceed to **STEP 6. REMOVE SHIPPING SUPPORTS** (page 43).

## SECTION II. ASSEMBLY - NORTH AMERICA

### B. CASE IH 23, 25 SERIES

#### 2300, 2500 Series

- a. Attach header to combine as follows:

#### Sliding Pin System

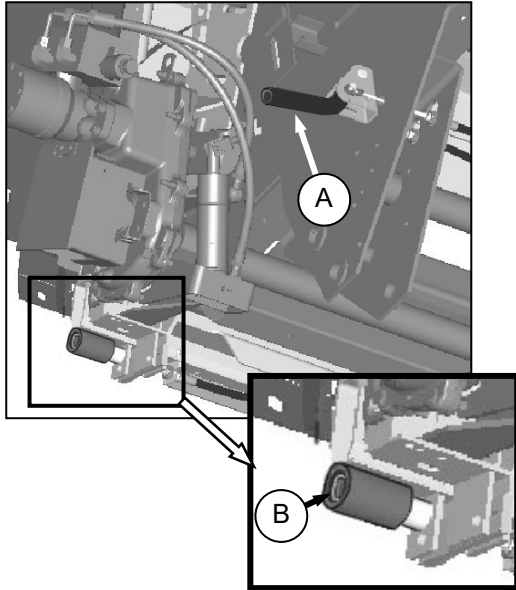

1. Move handle (A) on left side of feeder house to up position to retract both pins (B) at lower corners of feeder house.

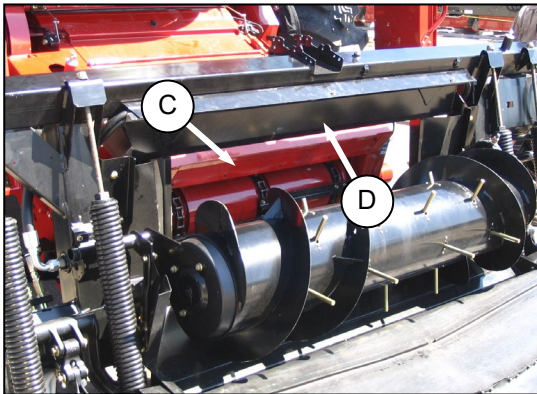

2. Slowly drive combine up to header until feeder house saddle (C) is directly under the adapter top cross member (D).
3. Raise feeder house slightly to lift header, ensuring feeder saddle is properly engaged in adapter frame.

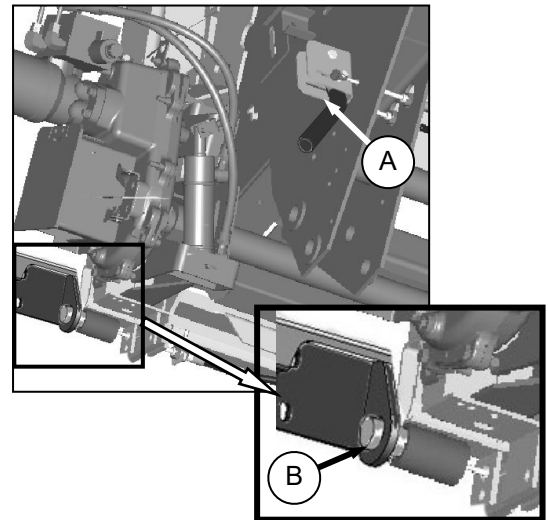

4. Lower handle (A) to engage pins (B) into adapter.
5. Proceed to step b.

#### Latch System



### WARNING

To avoid bodily injury or death from unexpected start-up or fall of raised attachment; stop engine, remove key and engage lift cylinder stop before proceeding with hook-up.

1. Slowly drive combine up to header until feeder house saddle (C) is directly under the adapter top cross member (D). See illustration opposite.
2. Raise feeder house fully and engage combine lift cylinder locks.

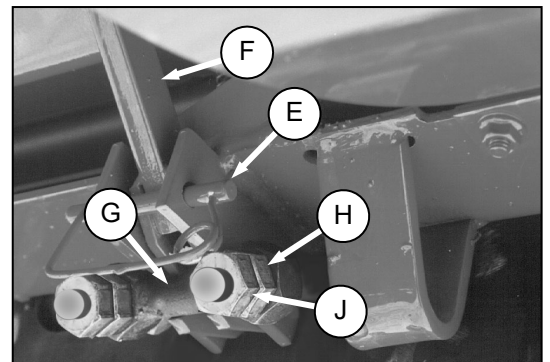

3. Remove pin (E) and lower latch handle (F) (one on each side of feeder house underside) to hook latch (G).
4. Lift handle to overcenter position to lock. Requires 40 - 50 lbf (180 - 220 N) to move handle overcenter. Adjust nuts (H) on U-bolts to vary force required on handle.

(continued next page)

## SECTION II. ASSEMBLY - NORTH AMERICA

5. Tighten jam-nuts (J) when force is correct.
  6. Install pin (E) as shown to secure latch handle in locked position.
  7. Remove combine lift cylinder locks and lower header to ground.
- b. Connect combine hydraulics to adapter as follows:

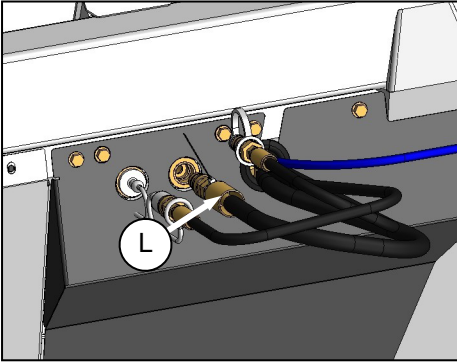
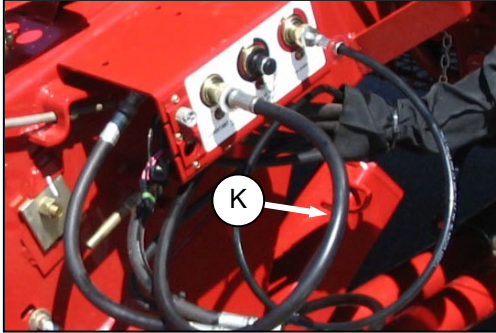

1. Disconnect reel drive hoses (K) and (L) (white discs) from combine and adapter receptacles.

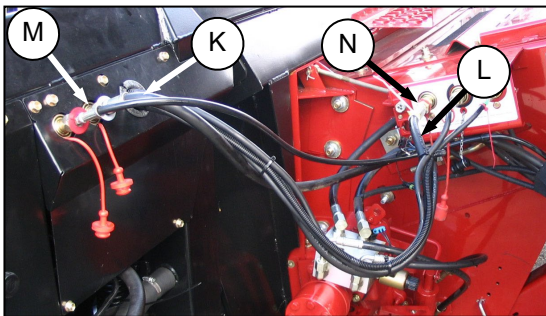

2. Connect hose (K) from combine to adapter coupler (M).
3. Connect hose (L) from the adapter to the combine coupler (N).

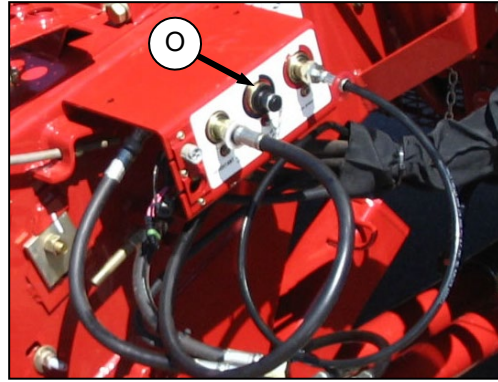

4. Remove plug from reel lift coupler (O) (black disc) on combine.

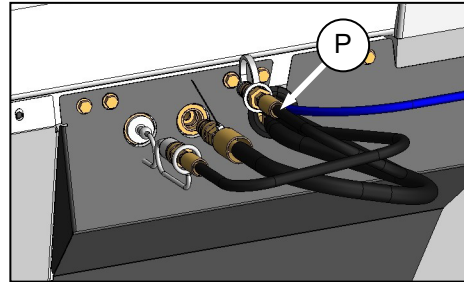

5. Remove red dust cap from reel lift hose (P) on adapter and connect hose to combine coupler (O).

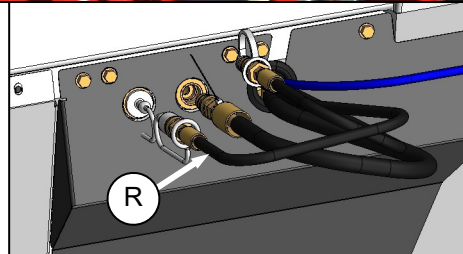
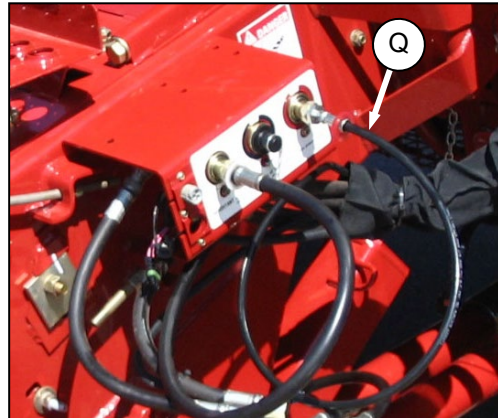

6. Disconnect reel fore-aft hoses (Q) and (R) (red discs) from combine and adapter receptacles.

*(continued next page)*

## SECTION II. ASSEMBLY - NORTH AMERICA

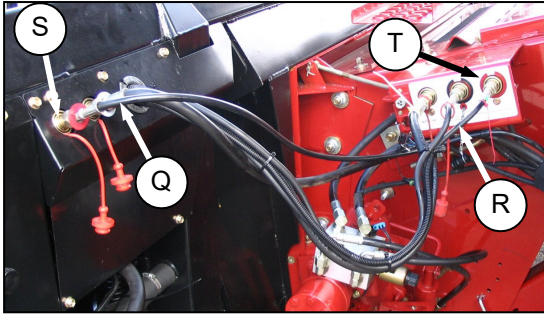

7. Connect hose (Q) from combine to adapter coupler (S).
8. Connect hose (R) from the adapter to the combine coupler (T).

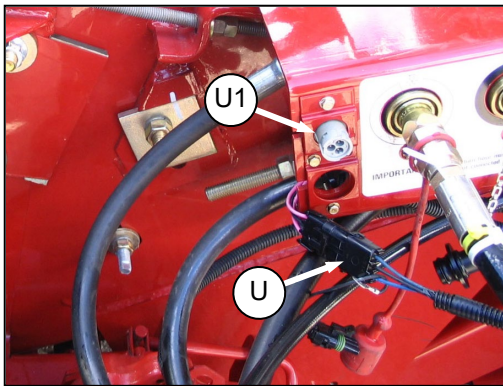

- c. Connect adapter electrical harness (U) to combine electrical connector, and if applicable connect AHHC wire harness at U1.

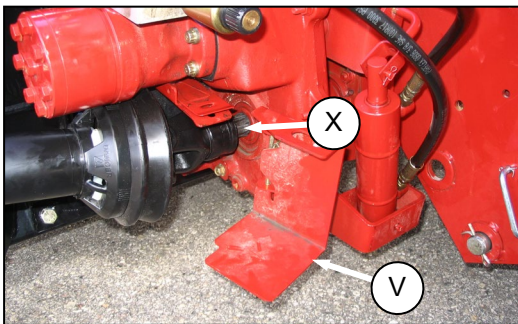

- d. Open guard (V) at combine output shaft.

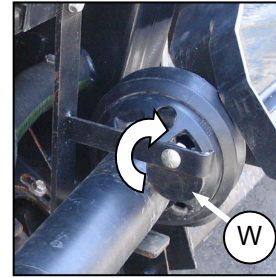

- e. Rotate disc (W) on adapter drive-line storage hook and remove drive-line from hook.
- f. Pull back collar on end of driveline and push onto combine output shaft (X) until collar locks. Close guard (V).

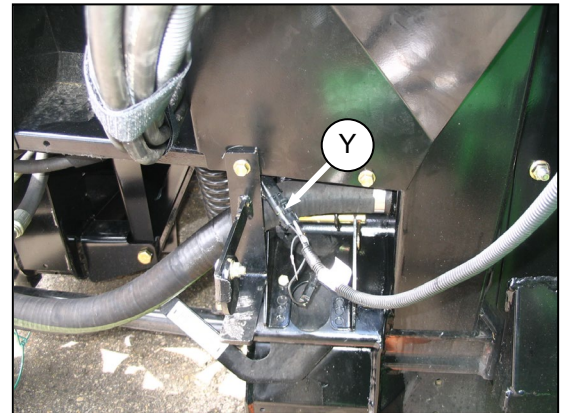

- g. If adapter is equipped with reel fore-aft/header tilt selector, connect harness (Y) to combine.

## SECTION II. ASSEMBLY - NORTH AMERICA

### C. JOHN DEERE 60, 70 SERIES

#### Contour Master, Level Land

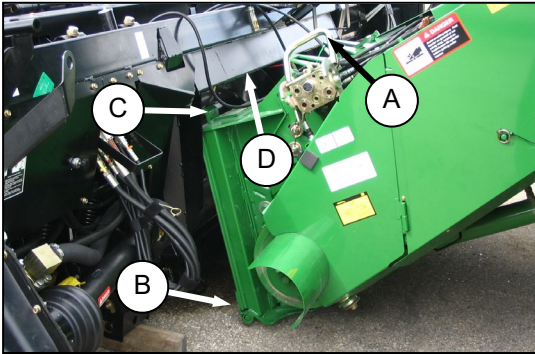

- a. Push handle (A) on combine coupler toward feeder house to retract pins (B) at bottom corners of feeder house.
- b. Slowly drive combine up to header until feeder house saddle (C) is directly under the adapter top cross member (D).
- c. Raise feeder house to lift header, ensuring feeder saddle is properly engaged in adapter frame.
- d. Position header slightly off the ground.



### CAUTION

Stop engine and remove key from ignition before leaving operator's seat for any reason. A child or even a pet could engage an idling machine.

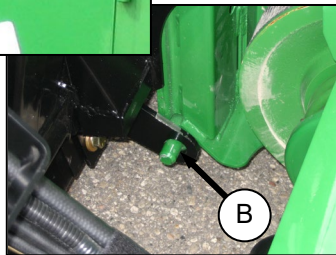
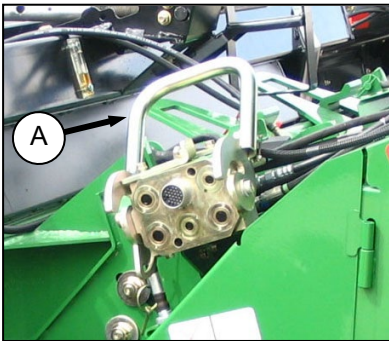

- e. Pull handle (A) to engage pins (B) in adapter.

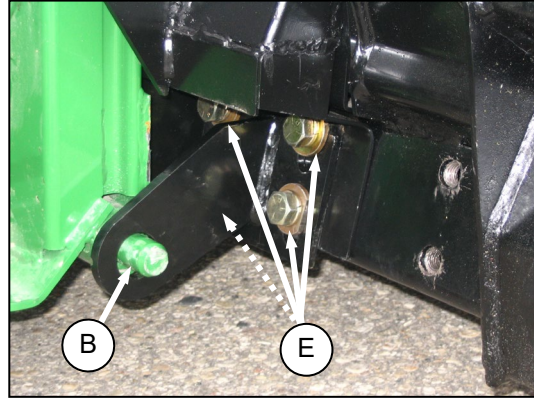

- f. Check that bolts (E) on adapter brackets are tight.
- g. If pins (B) do not fully engage adapter brackets, loosen bolts (E) and adjust bracket as required. Re-tighten bolts.
- h. Remove blocks from under cutterbar.
- i. Start engine and lower header.

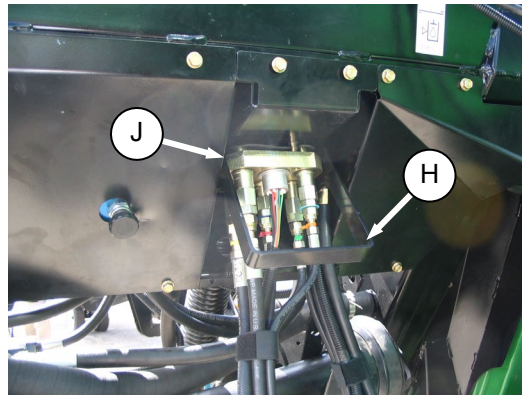

- j. Pull handle (H) on adapter to release coupler (J) from storage position. Remove coupler and push handle back into adapter to store.

*(continued next page)*



## SECTION II. ASSEMBLY - NORTH AMERICA

k. Attach coupler (J) to combine as follows:

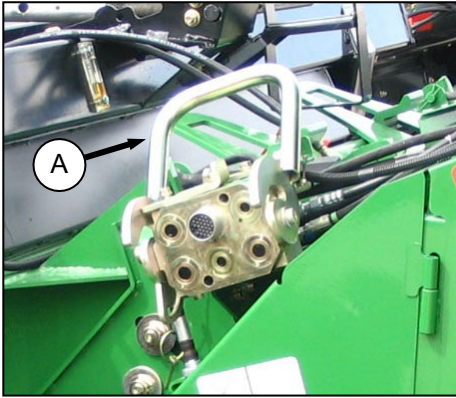

1. Handle (A) should be in the “nearly up” position. Clean receptacle.

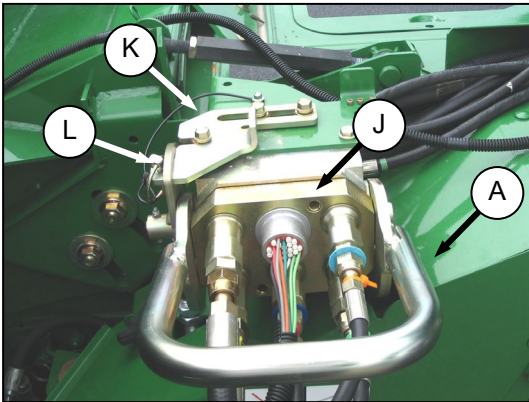

2. Locate coupler (J) onto receptacle and pull handle (A) so that lugs on coupler are engaged into handle.
3. Pull handle to full horizontal position as shown.
4. Slide latch (K) to lock handle in position, and secure with lynch pin (L).

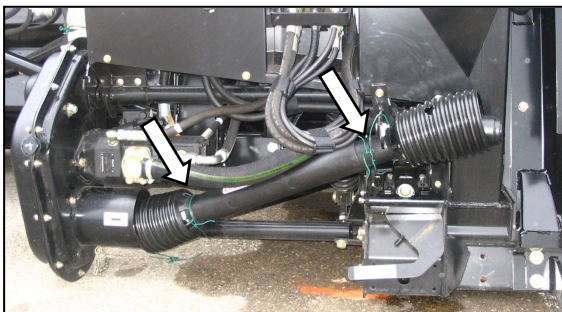

l. Remove shipping wire from driveline.

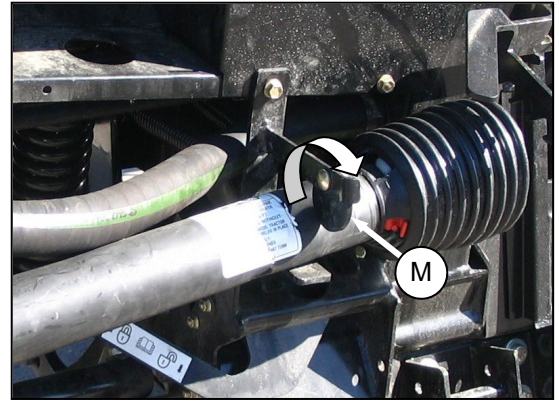

- m. Rotate disc (M) on adapter driveline storage hook and remove driveline from hook.

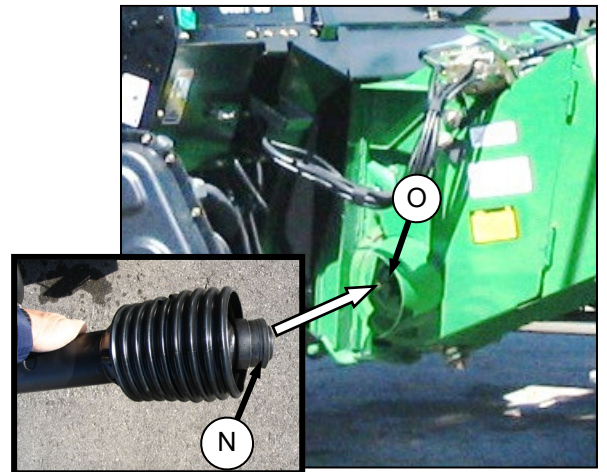

- n. Pull back collar (N) on end of driveline and push onto combine output shaft (O) until collar locks.

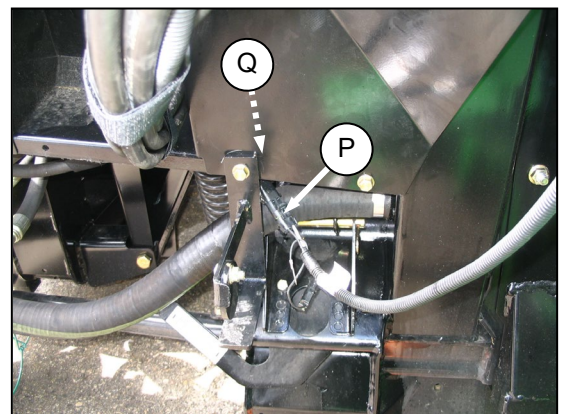

- o. If adapter is equipped with reel fore-aft/header tilt selector, connect harness (P) to combine.

### NOTE

*Connector (P) may need to be retrieved from hydraulics compartment access hole (Q).*

- p. Proceed to **STEP 6. REMOVE SHIPPING SUPPORTS** (page 43).

## SECTION II. ASSEMBLY - NORTH AMERICA

### D. JOHN DEERE 50 SERIES

#### Contour Master, Level Land

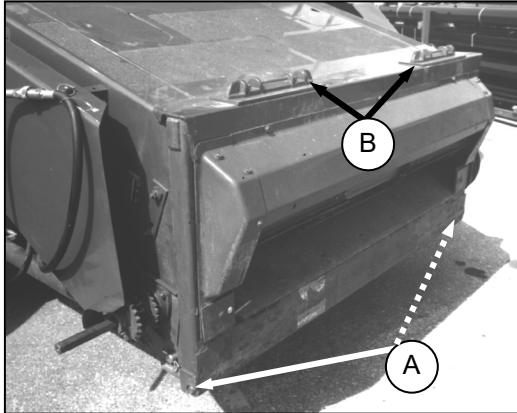

- a. Retract pins (A) at bottom corners of feeder house.

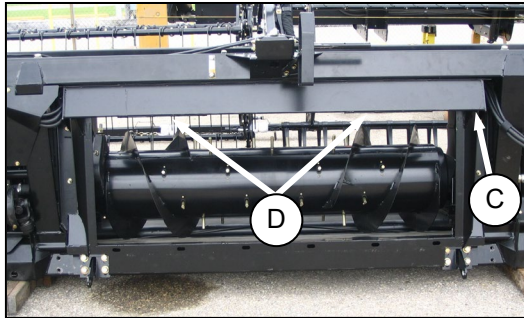

- b. Slowly drive combine up to header until feeder house lift lugs (B) are directly under the adapter top cross member (C).
- c. Raise feeder house to lift header, ensuring lift lugs (B) are properly engaged in adapter frame sockets (D).
- d. Position header slightly off the ground.



### CAUTION

Stop engine and remove key from ignition before leaving operator's seat for any reason. A child or even a pet could engage an idling machine.

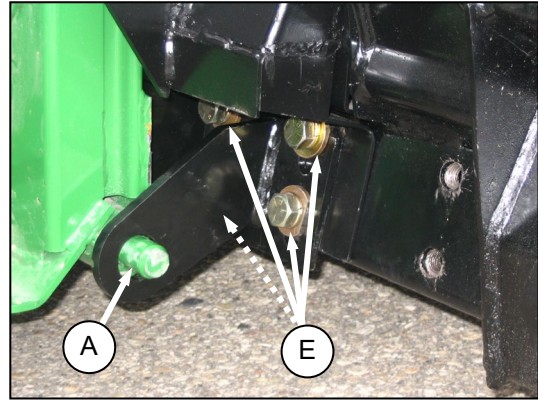

- e. Engage pins (A) in adapter.
- f. Check that bolts (E) on adapter brackets are tight.
- g. If pins (A) do not fully engage adapter brackets, loosen bolts (E) and adjust bracket as required. Re-tighten bolts.
- h. If required, remove blocks from under cutterbar.
- i. Start engine and lower header.
- j. At left side of combine feeder house, retrieve reel aft hose, reel lift hose and electrical harness.

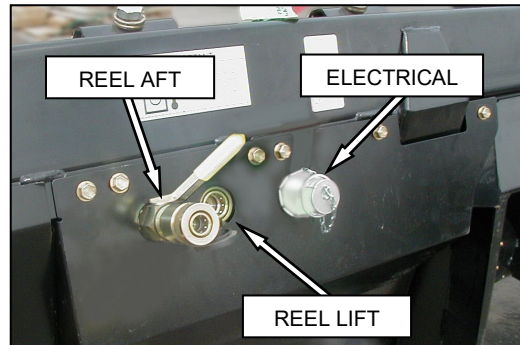

- k. Clean couplers and attach as shown above.
- l. At right side of feeder house, disconnect reel drive hoses and retrieve reel fore hose.

*(continued next page)*

## SECTION II. ASSEMBLY - NORTH AMERICA

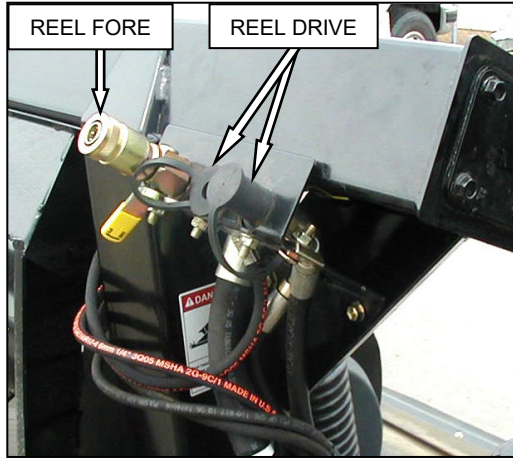

m. Clean couplers and attach as shown above.

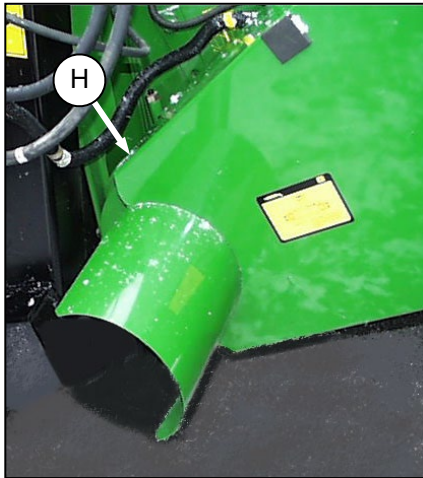

n. Open shield (H) on combine.

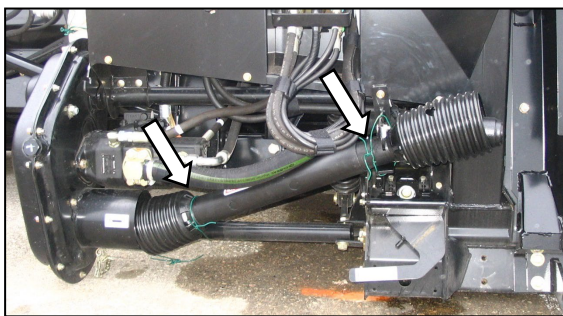

o. Remove shipping wire securing driveline to adapter.

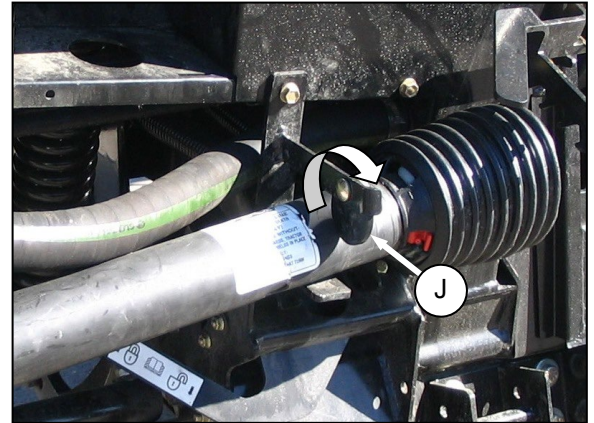

p. Rotate disc (J) on adapter driveline storage hook and remove driveline from hook.

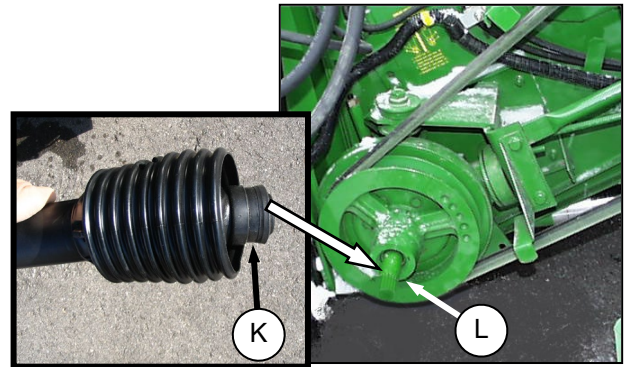

q. Pull back collar (K) on end of driveline and push onto combine output shaft (L) until collar locks.

r. Close driveshield (H) on combine.

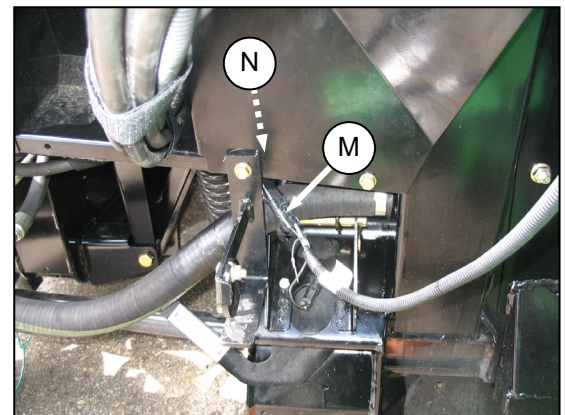

s. If adapter is equipped with reel fore-aft/header tilt selector, connect harness (M) to combine.

### NOTE

*Connector (M) may need to be retrieved from hydraulics compartment access hole (N).*

t. Proceed to **STEP 6. REMOVE SHIPPING SUPPORTS** (page 43).

## SECTION II. ASSEMBLY - NORTH AMERICA

### E. CAT LEXION 400, 500 SERIES

CAT Lexion 400, 500(R) combines

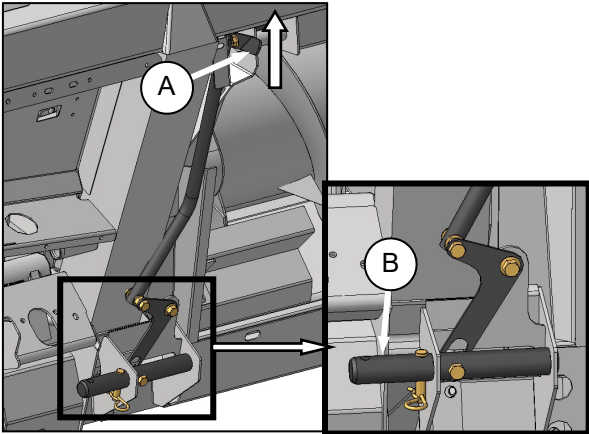

- Handle (A) on the CA20 adapter should be in raised position and pins (B) at bottom corners of adapter retracted.
- Slowly drive combine up to header until feeder house is directly under the adapter top cross member.

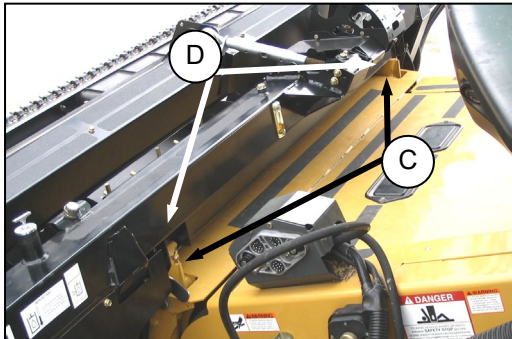

- Raise feeder house to lift header, ensuring feeder house posts (C) are properly engaged in adapter frame (D).
- Position header slightly off the ground.



### CAUTION

Stop engine and remove key from ignition before leaving operator's seat for any reason. A child or even a pet could engage an idling machine.

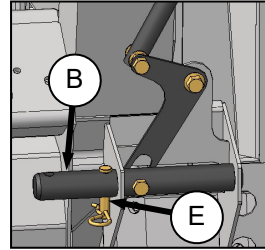

- Remove locking pin (E) from adapter pin (B).

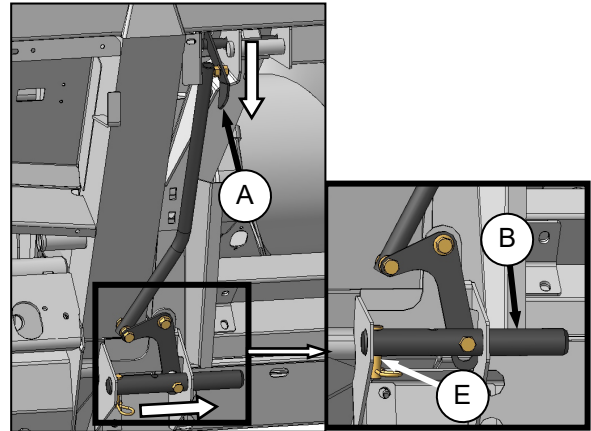

- Lower handle (A) to engage adapter pins into feeder house. Re-insert locking pin (E) and secure with hairpin.
- Remove blocks from under cutterbar.
- Start engine and lower header. Shut down the combine.

*(continued next page)*

## SECTION II. ASSEMBLY - NORTH AMERICA

i. Connect hydraulic hoses as follows:

### 500 Series

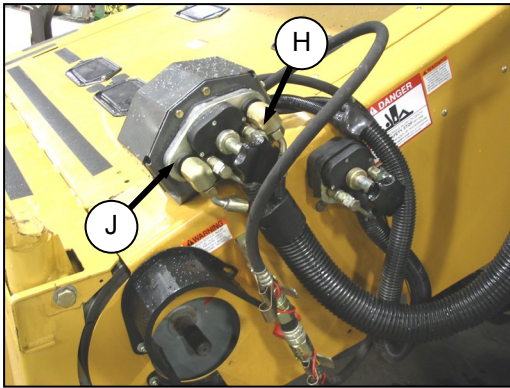

1. Unscrew knob (H) on combine coupler (J) to release coupler from combine receptacle.

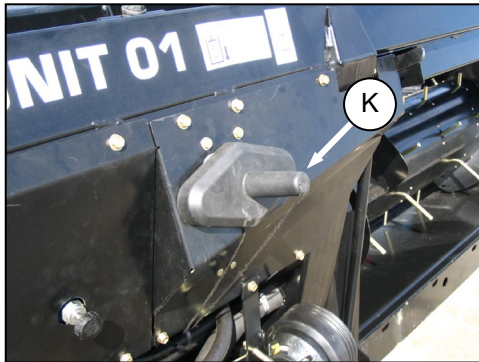

2. Remove cover (K) from adapter receptacle.

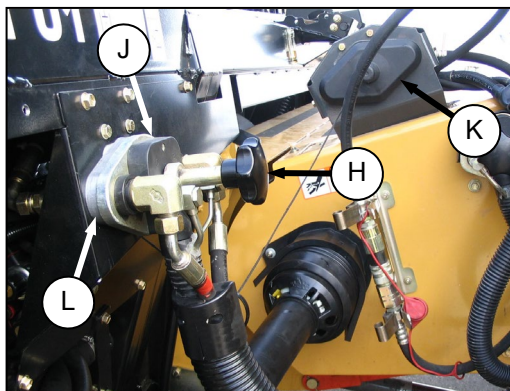

3. Locate coupler (J) onto adapter receptacle (L) and turn knob (H) to secure coupler to receptacle.
4. Place cover (K) on combine receptacle.
5. Proceed to step j.

### 400 Series

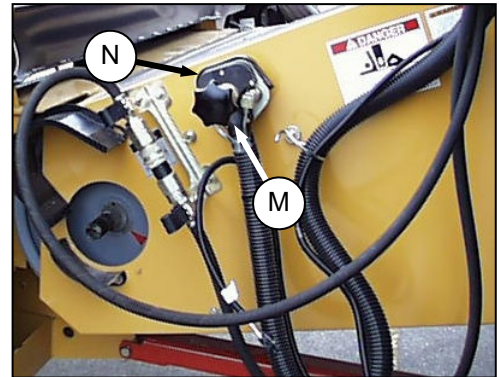

1. Unscrew knob (M) on combine coupler (N) to release coupler from combine receptacle.

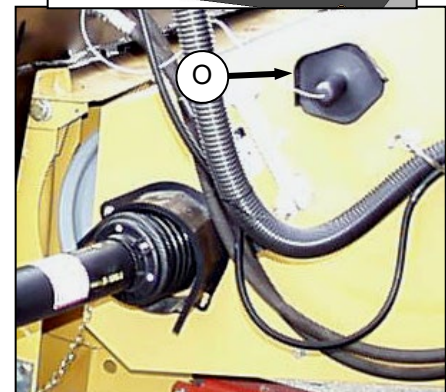
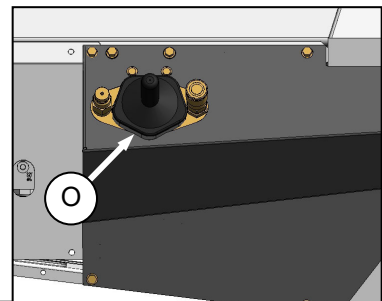

2. Remove cover (O) from adapter receptacle and place on combine receptacle.

*(continued next page)*

## SECTION II. ASSEMBLY - NORTH AMERICA

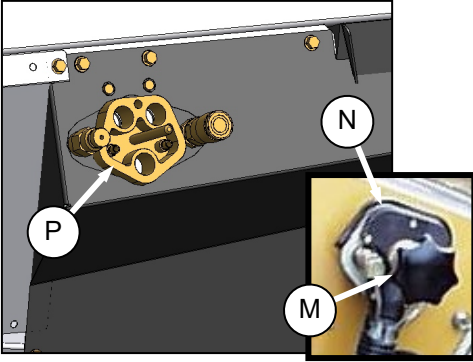

3. Locate coupler (N) onto adapter receptacle (P) and turn knob (M) to secure coupler to receptacle.

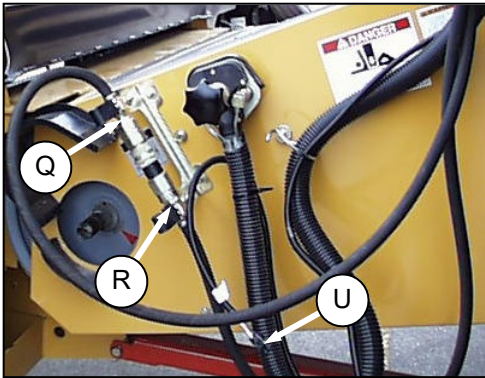

4. Disconnect hoses (Q) and (R) on combine at couplers.

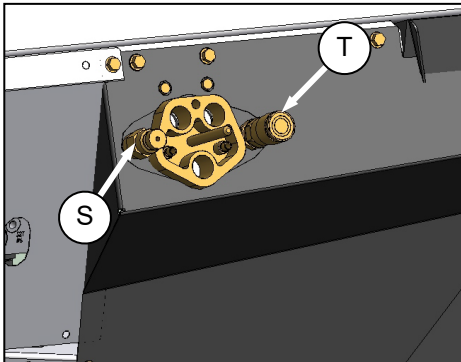

5. Connect hose (Q) to coupler (S) on adapter.
6. Connect hose (R) to coupler (T) on adapter.
7. Connect wiring harness (U) to adapter connector (not shown).

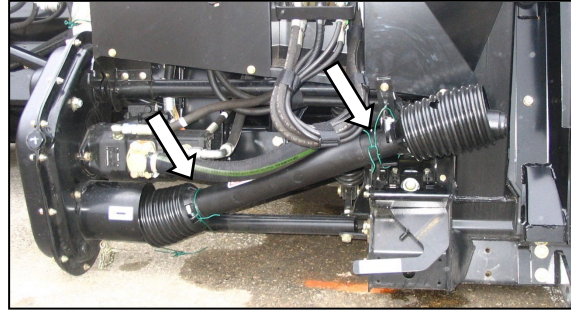

- j. Remove shipping wire securing driveline to adapter.

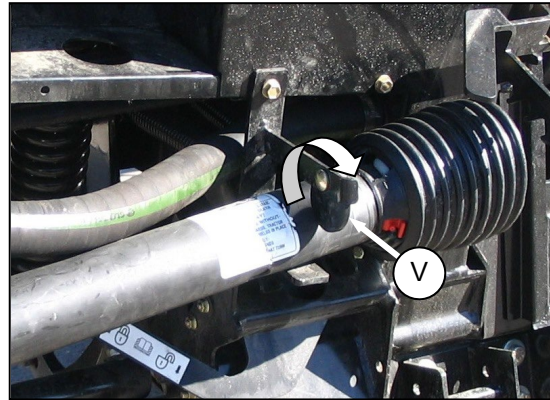

- k. Rotate disc (V) on adapter driveline storage hook and remove driveline from hook.

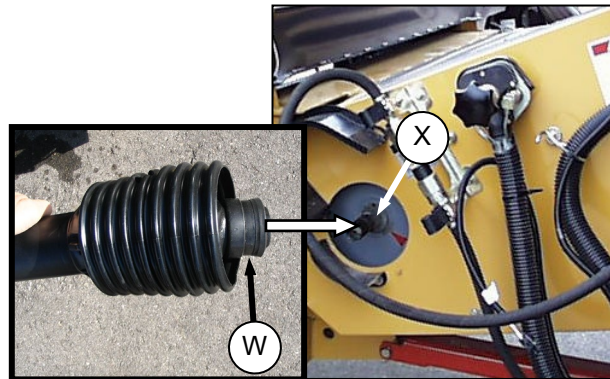

- l. Pull back collar (W) on end of driveline and push onto combine output shaft (X) until collar locks.

*(continued next page)*

## SECTION II. ASSEMBLY - NORTH AMERICA

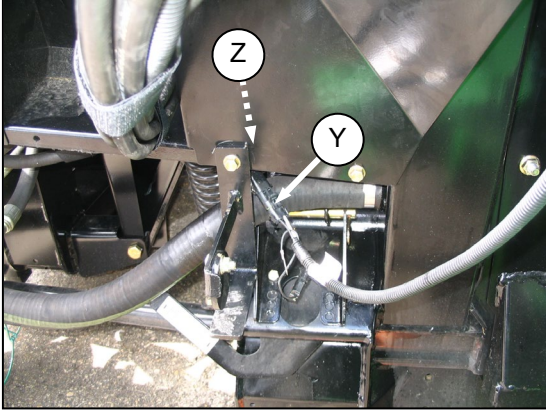

- m. If adapter is equipped with reel fore-aft/header tilt selector, connect harness (Y) to combine.

### NOTE

*Connector (Y) may need to be retrieved from hydraulics compartment access hole (Z).*

- n. Proceed to **STEP 6. REMOVE SHIPPING SUPPORTS** (page 43).

## SECTION II. ASSEMBLY - NORTH AMERICA

### F. NEW HOLLAND CR, CX SERIES

#### CR, CX Series

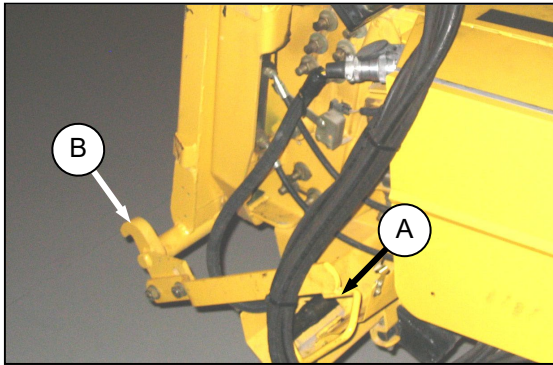

- a. Ensure handle (A) is positioned so that hooks (B) can engage adapter.

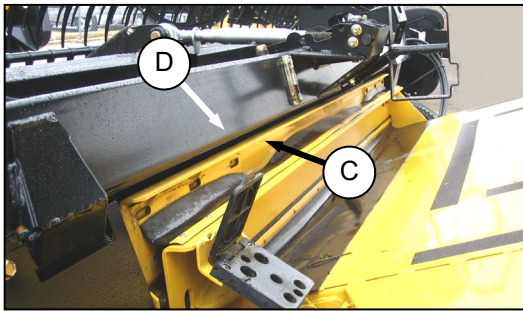

- b. Slowly drive combine up to header until feeder house saddle (C) is directly under the adapter top cross member (D).
- c. Raise feeder house to lift header, ensuring feeder saddle is properly engaged in adapter frame.



#### CAUTION

**Stop engine and remove key from ignition before leaving operator's seat for any reason. A child or even a pet could engage an idling machine.**

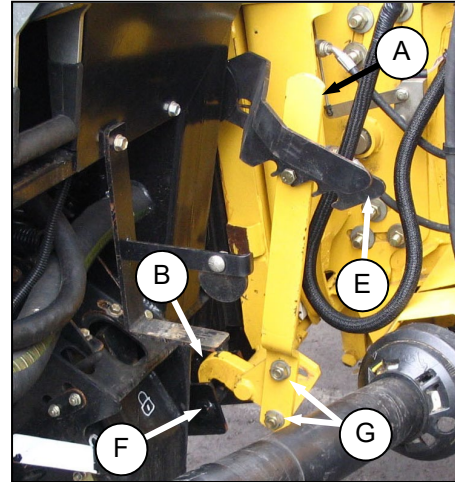

- d. Lift lever (E) on adapter at left side of feeder house and push handle (A) on combine so that hooks (B) engage pins (F) on both sides of the feeder house.
- e. Push down on lever (E) so that slot in lever engages handle to lock handle in place.
- f. If hook (B) does not fully engage pin on adapter when (A) and (E) are engaged, loosen bolts (G) and adjust lock as required. Re-tighten bolts.

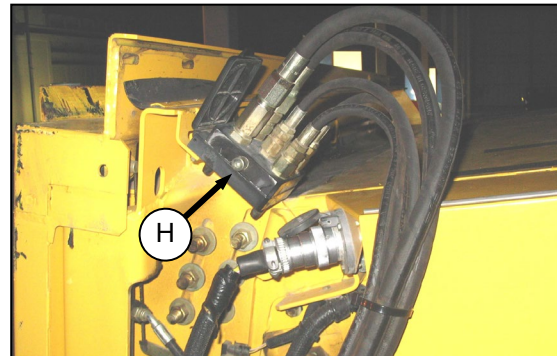

- g. Remove hydraulic quick coupler (H) from storage plate on combine.

*(continued next page)*



## SECTION II. ASSEMBLY - NORTH AMERICA

h. Connect to receptacle on adapter as follows:

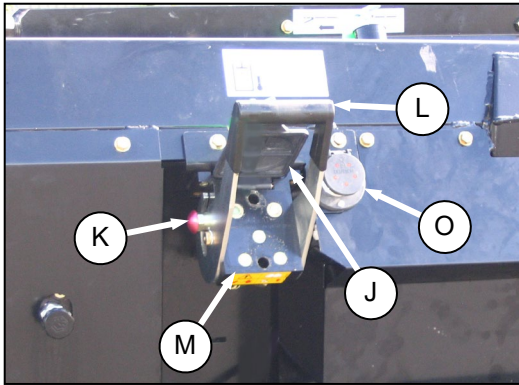

1. Open cover (J).
2. Push in lock button (K) and pull handle (L) halfway up to open position.

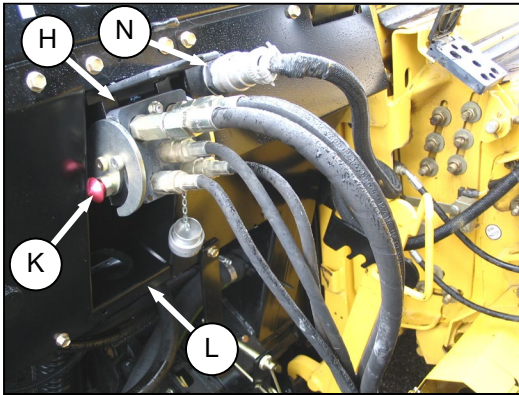

3. Position coupler onto adapter receptacle (M) and push handle (L) to engage pins into receptacle.
4. Push handle (L) to closed position until lock button (K) snaps out.

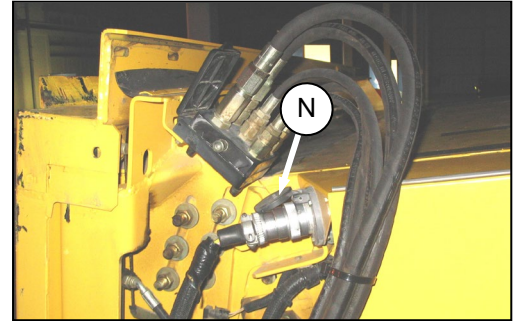

- i. Attach combine electrical connector (N) to adapter as follows:
  1. Remove cover on adapter electrical receptacle (O).
  2. Remove connector (N) from combine.
  3. Align lugs on connector (N) with slots in adapter receptacle (O), and push connector onto receptacle. Turn collar on connector to lock it in place.

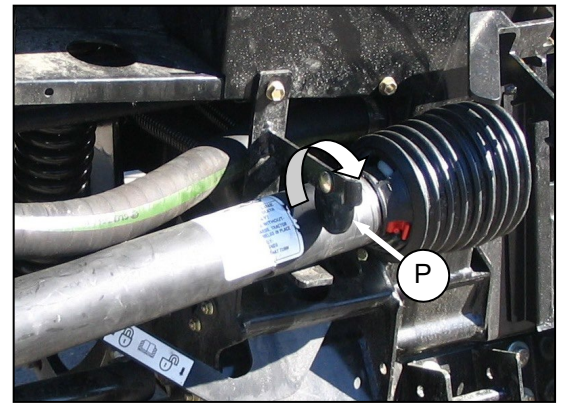

- j. Rotate disc (P) on adapter drive-line storage hook and remove drive-line from hook.

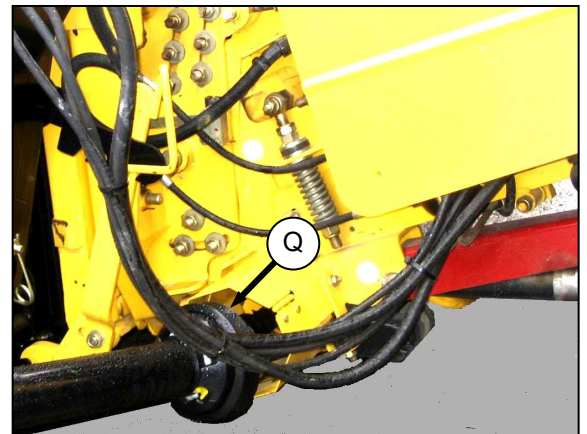

- k. Pull back collar on end of driveline and push onto combine output shaft (Q) until collar locks.

## SECTION II. ASSEMBLY - NORTH AMERICA

### G. AGCO

Gleaner R Series and A Series  
Challenger 660, 670, and 680B  
Massey 9690, 9790, and 9895

#### IMPORTANT

Some combine models require shorter center-link components to ensure clearance to the combine cab. To avoid damage to your combine, lift feeder slowly and check clearance between cab and header center-link. If clearance is inadequate, contact your dealer to order short center-link components. Refer to **STEP 4. SET-UP ADAPTER**.

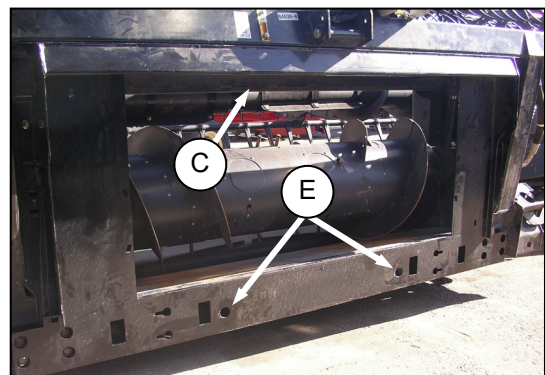
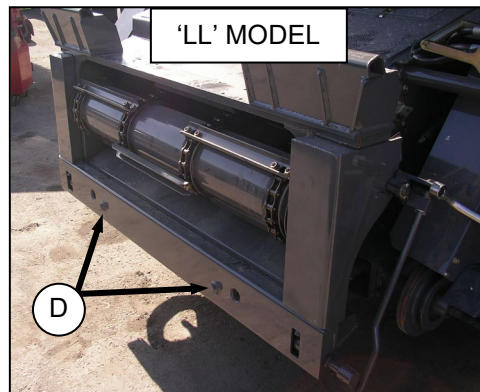
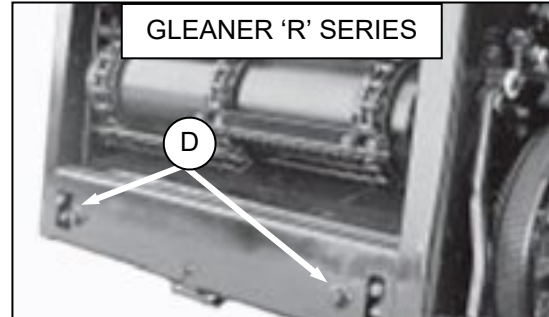
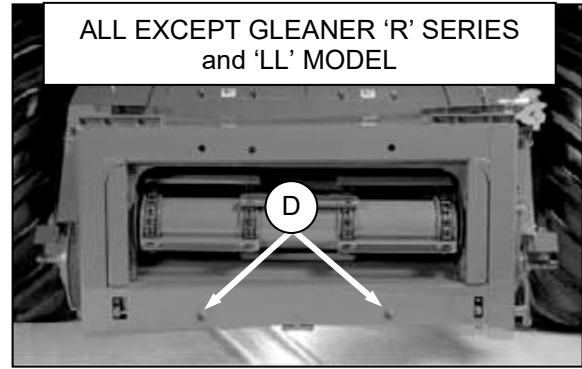
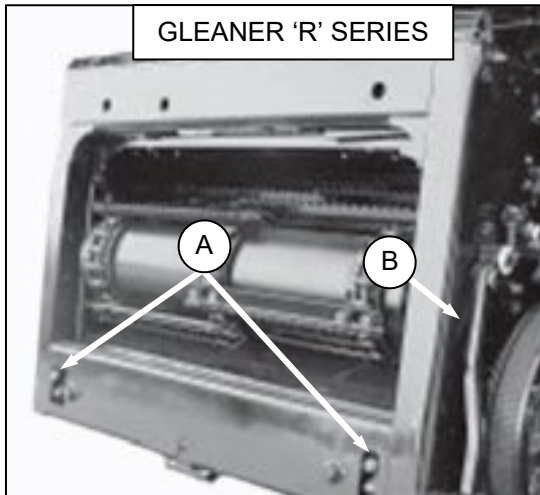

a. Retract lugs (A) at base of feeder-house with lock handle (B).

b. Slowly drive combine up to header until feeder house is directly under the adapter top cross member (C) and alignment pins (D) are aligned with holes (E) in adapter frame.

*(continued next page)*

## SECTION II. ASSEMBLY - NORTH AMERICA

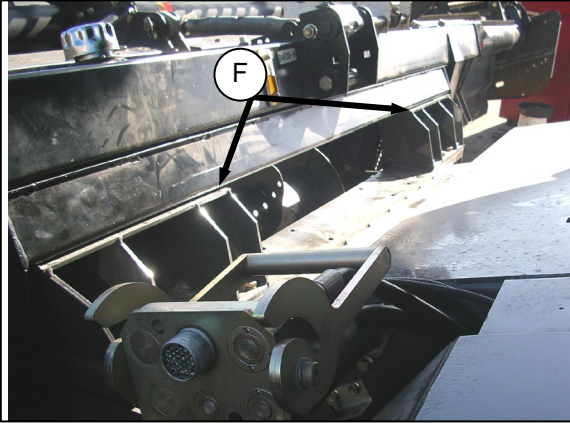

- c. Raise feeder house to lift header, ensuring feeder house saddle (F) and alignment pins are properly engaged in adapter frame.
- d. Position header slightly off the ground.



### CAUTION

Stop engine and remove key from ignition before leaving operator's seat for any reason. A child or even a pet could engage an idling machine.

ALL EXCEPT GLEANER 'R' SERIES

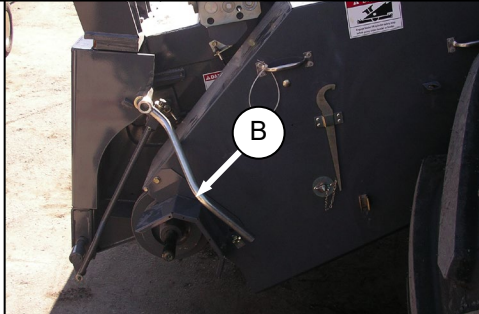

GLEANER 'R' SERIES

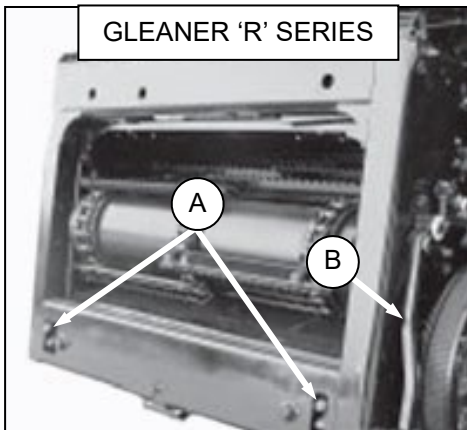

- e. Engage lugs (A) with adapter using lock handle (B).
- f. Remove blocks from under cutterbar.

- g. Start engine and lower header. Shut down the combine.

### NOTE

The CA20 Combine Adapter is equipped with a multi-coupler that connects to the combine. If your combine is equipped with individual connectors, a multi-coupler kit (single-point connector) must be installed.

The kits are available through your AGCO dealer and include installation instructions.

COMBINE	AGCO KIT #
Challenger	71530662
Massey	71411594
Gleaner 'R' Series	71414706

- h. Connect adapter hydraulic quick coupler to combine receptacle as follows:

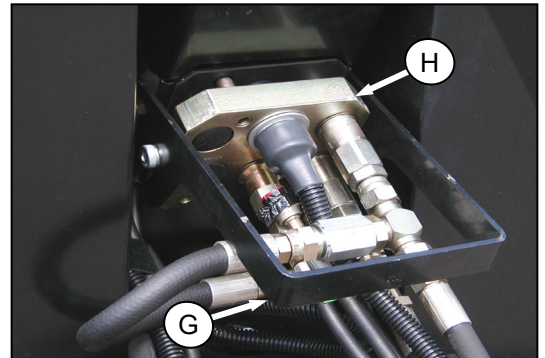

1. Pull handle (G) to release coupler (H) from adapter.

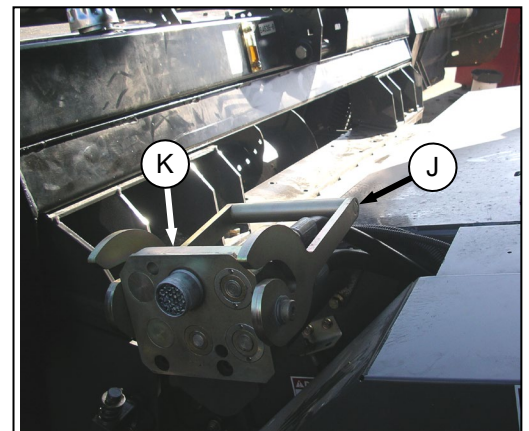

2. Push handle on combine (J) to full open position. Clean receptacle (K).

(continued next page)

## SECTION II. ASSEMBLY - NORTH AMERICA

3. Position coupler (H) onto combine receptacle (K) and pull handle to fully engage coupler into receptacle.

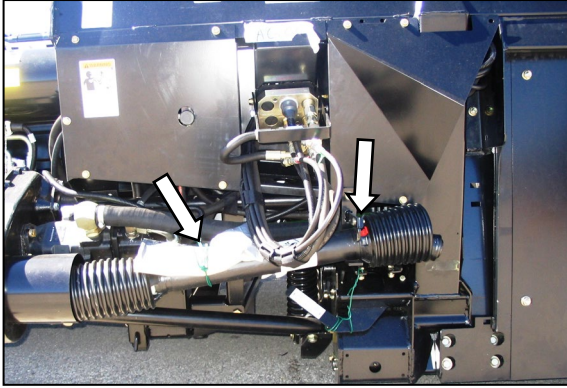

- i. Remove shipping wire securing driveline to adapter.

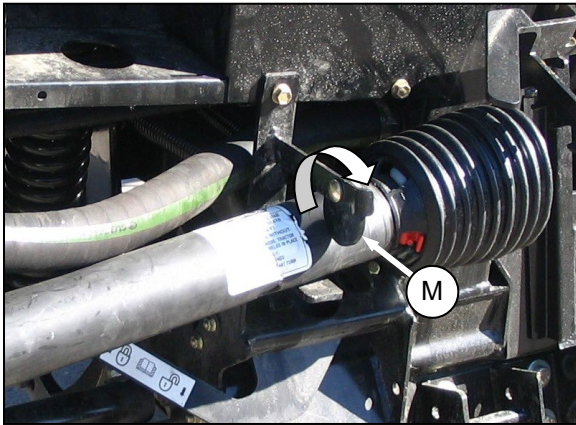

- j. Rotate disc (M) on adapter driveline storage hook and remove driveline from hook.

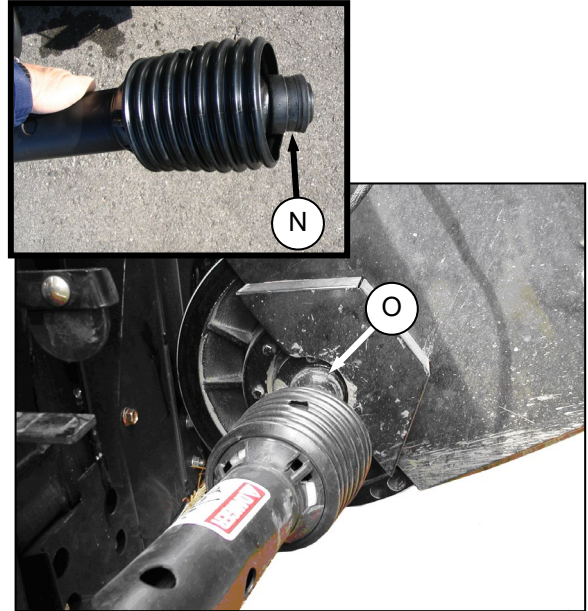

- k. Pull back collar (N) on end of driveline and push onto combine output shaft (O) until collar locks.

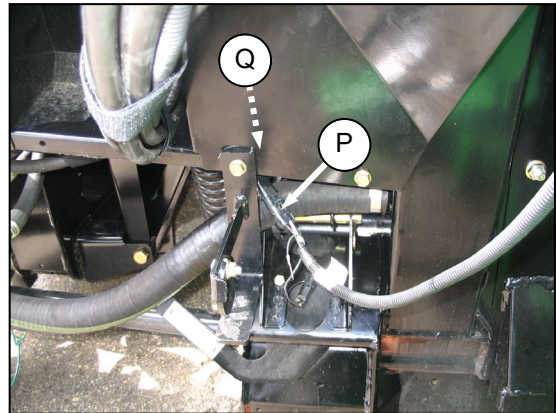

- l. Connect harness (P) to combine.

### NOTE

*Connector (P) may need to be retrieved from hydraulics compartment access hole (Q).*

- m. Proceed to **STEP 6. REMOVE SHIPPING SUPPORTS** (page 43).
- n. For Export configuration, proceed to **SECTION III STEP 12. CONNECT FORE-AFT CYLINDERS.**

## SECTION II. ASSEMBLY - NORTH AMERICA

### STEP 6. REMOVE SHIPPING SUPPORTS

The removable supports are painted yellow. Refer to illustrations and remove supports as follows:

#### NOTE

*Unless otherwise specified, discard supports, and all shipping material and hardware.*

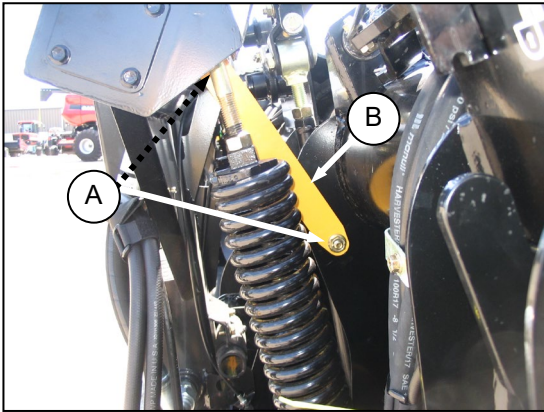

- a. Remove two bolts (A) and remove strap (B) from both sides of center frame.

#### NOTE

*If strap is difficult to remove, lift on one end of header to release the load on the strap so that bolts can be removed.*

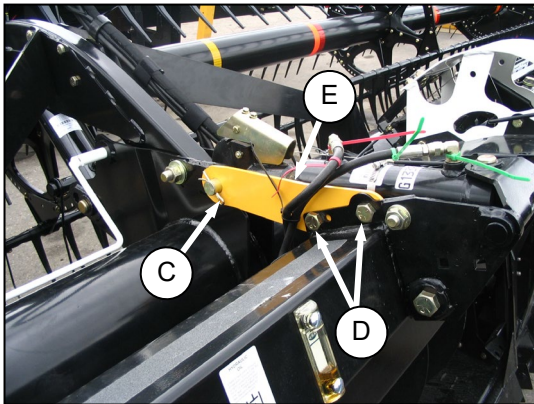

- b. Remove cotter pin (C), bolts (D), and remove shipping brace (E).
- c. Re-install cotter pin (C).

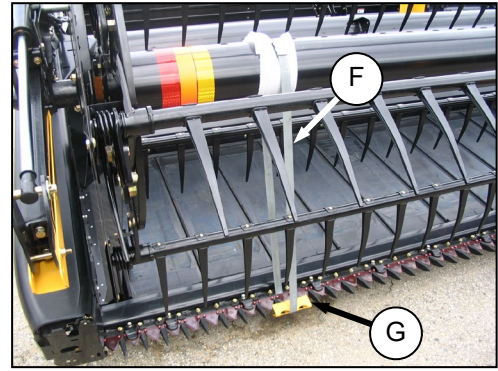

- d. Cut banding (F) securing reel to cutterbar and remove angle (G) on cutterbar and packing material from reel tube at three locations.



#### CAUTION

**Reel arms must be level prior to removing reel shipping braces. Failure to do so may result in reel moving suddenly.**

- e. Start combine, and level the reel arms with the combine hydraulics.

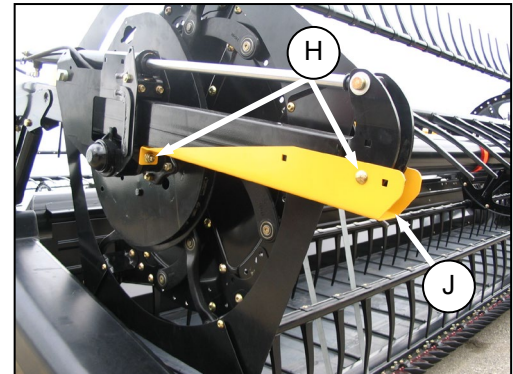

- f. Remove two bolts (H) attaching fore-aft brace (J) to reel arm and remove brace. Repeat for opposite arm and center arm.

### STEP 7. POSITION TRANSPORT LIGHTS



Position light perpendicular to header. Lights are located on each of the outboard reel arms.

## SECTION II. ASSEMBLY - NORTH AMERICA

### STEP 8. INSTALL CROP DIVIDERS

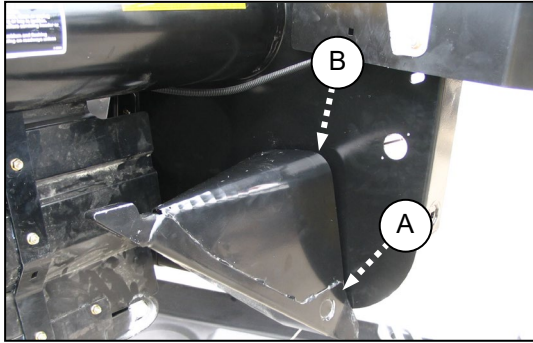

- a. At divider storage location, lift divider to disengage lugs (A) at lower end and then lower it slightly to disengage pin (B) from endsheet.

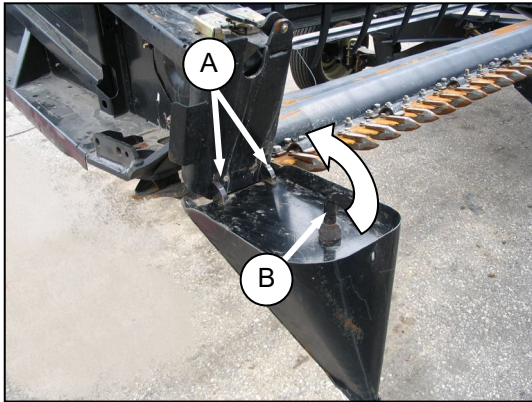

- b. Position crop divider as shown by locating lugs (A) in holes in endsheet.

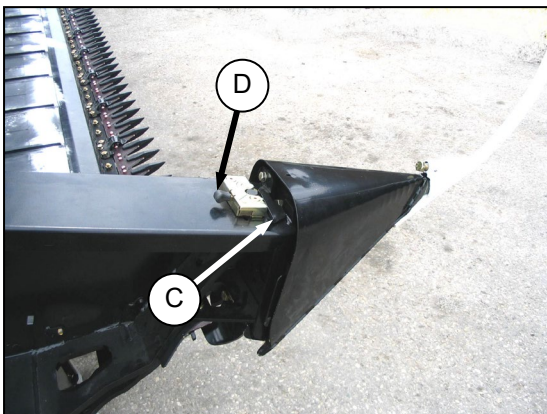

- c. Lift forward end of divider until pin (B) at top of divider engages and closes latch (C).
- d. Push safety lever (D) down to lock pin in latch.

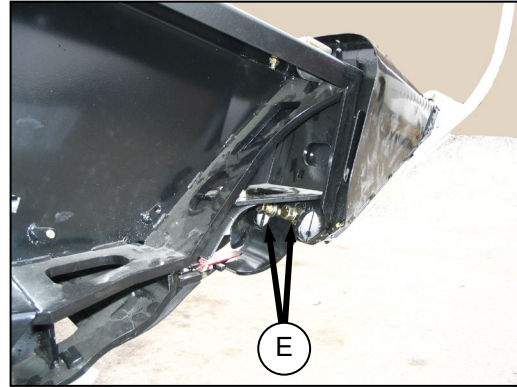

- e. Check that divider does not move laterally. Adjust bolts (E) as required to tighten divider and remove lateral play when pulling at divider tip.

### STEP 9. TRIM DRAPER DEFLECTORS

Trim existing deflectors as follows:

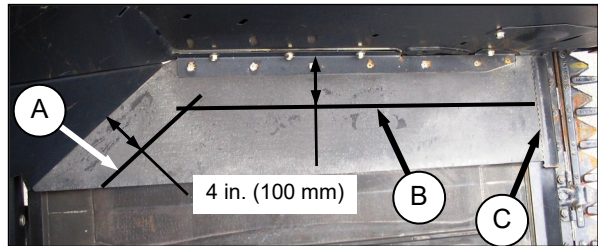

- a. Mark a straight line (A) on the deflector 4 in. (100 mm) from and parallel to the back edge of the deflector.
- b. Mark another line (B) on the deflector 4 in. (100 mm) from and parallel to the endsheet.
- c. Using a sharp knife, cut rubber deflector along the lines (A) and (B), taking care not to cut the draper underneath the deflector.
- d. Cut the rubber deflector along the steel retainer (C) from the inboard edge up to line (B) and remove the excess rubber.



DEFLECTOR AFTER TRIMMING

- e. Use the cut-off portion of deflector as a template to rework the deflector on the opposite end.

## SECTION II. ASSEMBLY - NORTH AMERICA

### STEP 10. INSTALL KNIFE HEAD SHIELDS

- a. Raise reel fully, lower header to ground, shutdown combine, and remove key.



#### CAUTION

Always engage reel props before working under reel.

- b. Engage reel arm locks.



#### DANGER

To avoid bodily injury or death from unexpected start-up or fall of raised machine, stop engine, remove key and engage lift cylinder stops before going under machine.

#### NOTE

*The knife head shield is supplied in flattened form and can be bent to suit installation on pointed or stub guard cutterbars, and on double knife headers.*



#### CAUTION

Wear heavy gloves when working around or handling sickles.

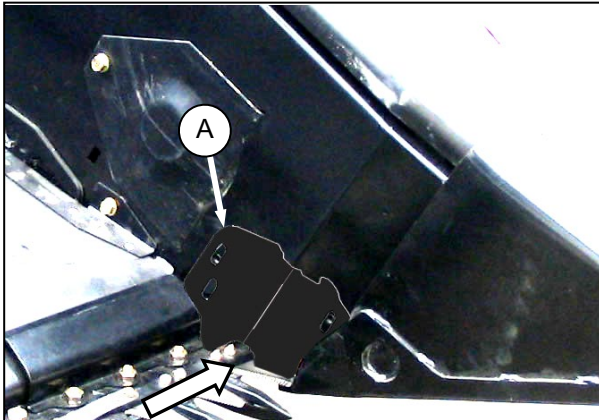

- c. Locate knife head shield (A) against endsheet as shown.
- d. Orient the shield so that cutout matches profile of knife head.
- e. Bend shield along slit to conform to endsheet.

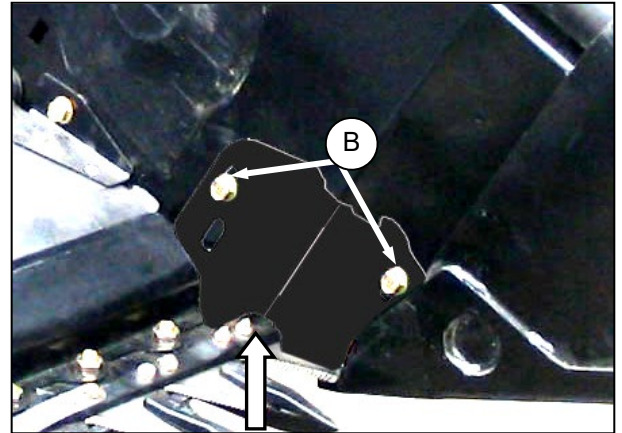

- f. Place shield on endsheet, align mounting holes, and install two 3/8 in. x 1/2 Torx head bolts (B).
- g. Snug up the bolts just enough so that shield can be adjusted as close as possible to knife head.
- h. Manually rotate wobble box pulley to move knife and check for areas of contact between the knife head and shield.
- i. If required, adjust shield to avoid interference with the knife.
- j. Tighten bolts.

### STEP 11. PRE-DELIVERY CHECKS

Refer to SECTION IV. PRE-DELIVERY CHECKS.

## SECTION III. ASSEMBLY - EXPORT

- c. Remove the two braces securing adapter to header, and discard.

## SECTION III. ASSEMBLY - EXPORT

### NOTE

*Some procedures in this section refer to steps in SECTION II. ASSEMBLY - NORTH AMERICA.*

### STEP 1. INSTALL CENTER-LINK

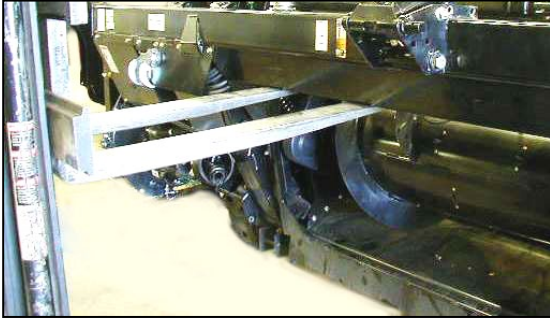

- a. Support the adapter with a forklift or crane.

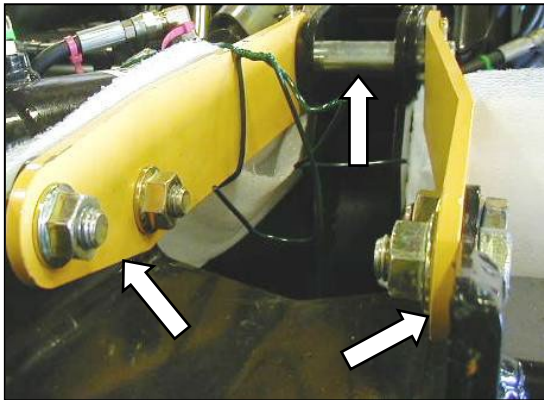

- b. Remove four bolts and pin, and remove the two shipping brackets between the adapter and header at the center-link location. Re-install pin and secure with cotter pins. Discard the shipping brackets.

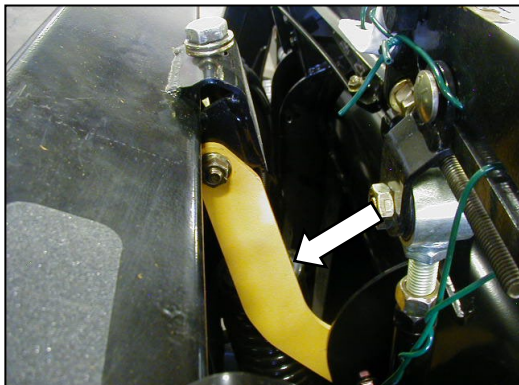



## SECTION III. ASSEMBLY - EXPORT

### IMPORTANT

Some combine models require shorter center-link components to ensure clearance to the combine cab. The following combine models have been identified for requiring the shorter center-link components: See **SECTION II. STEP 4. SET-UP ADAPTER** for additional information.

- Case IH 5088, 6088, and 7088 without Stone Traps.
  - Gleaner R Series.
- d. If necessary, obtain the shorter center-link assembly kit and install in accordance with the instructions provided with the kit. Otherwise, proceed with the next step.
- e. Remove the center-link clevis assembly and cylinder from shipping position on the center reel arm.
- f. Install the bracket assembly for the center-link with one  $\frac{3}{4}$  in. x 8.5 long hex bolt, two  $\frac{5}{8}$  in. x 1.5 long carriage bolts, and nuts provided with the assembly.
- g. Install center-link with pin at adapter.

*(continued next page)*

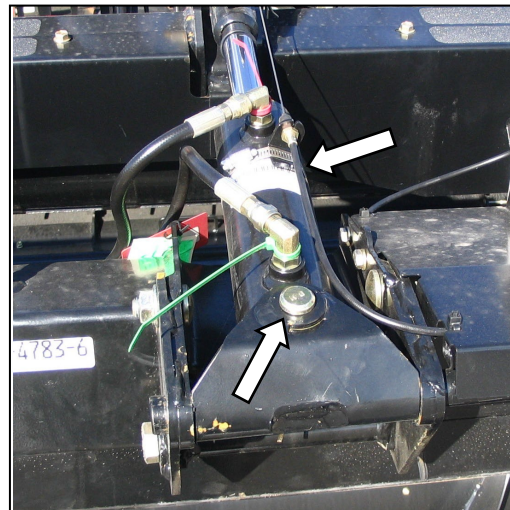
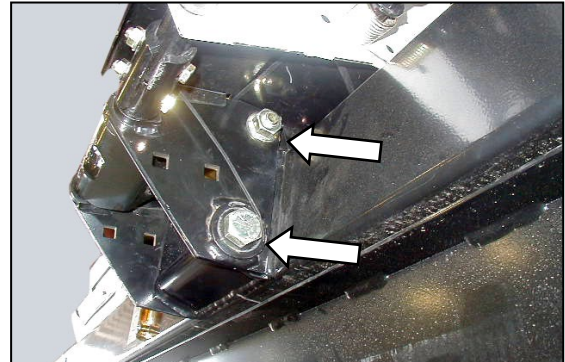

### SECTION III. ASSEMBLY - EXPORT

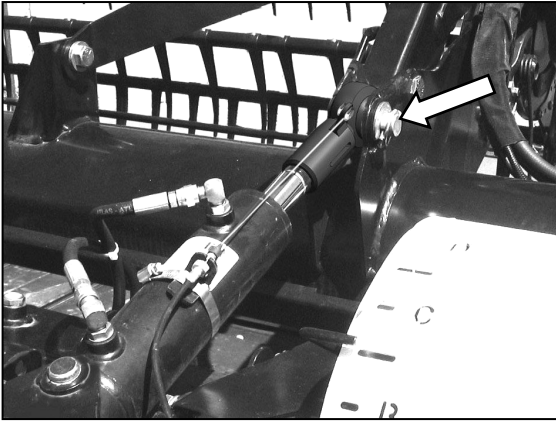

- h. For **eye type** center-link, remove pin in header bracket. Loosen hydraulic fittings on cylinder and extend or retract cylinder so pin can be re-installed through eye and header bracket. Re-tighten fittings.

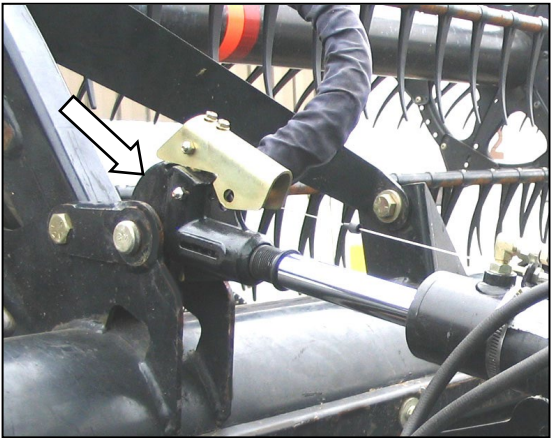

- i. For optional **hook type** center-link, loosen hydraulic fittings on cylinder and extend or retract cylinder so that hook engages header bracket. Re-tighten fittings.
- j. Remove the float indicator assembly from the shipping position on the center reel arm brace. Ensure cables are not kinked or damaged.

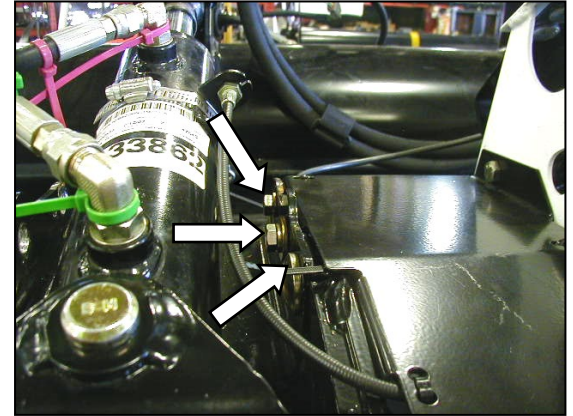
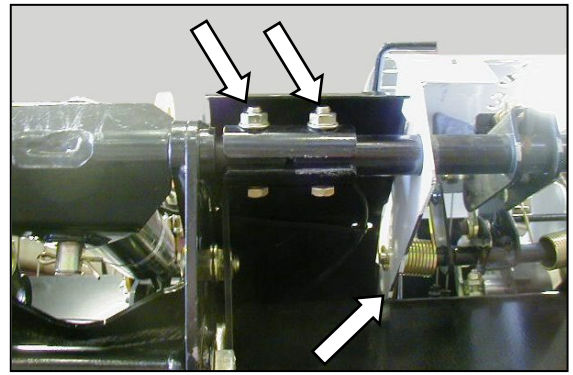

- k. Attach the float indicator assembly with two 3/8 in. x 2.0 hex bolts and nuts, and two 3/8 in. x 0.75 long hex bolts, lock washers, and flat washers provided with the assembly.

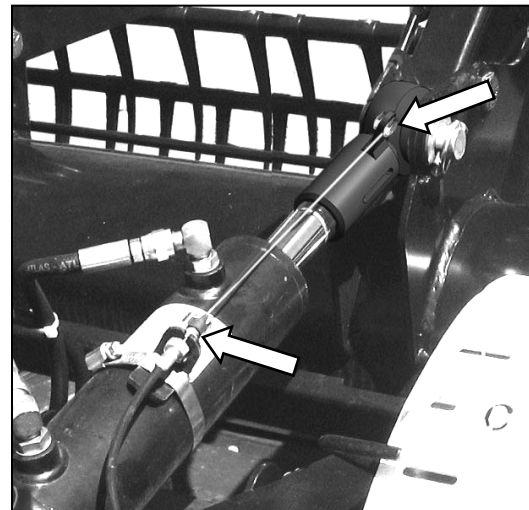

- l. Attach cable to cylinder at barrel, and at eye.  
(continued next page)

### SECTION III. ASSEMBLY - EXPORT

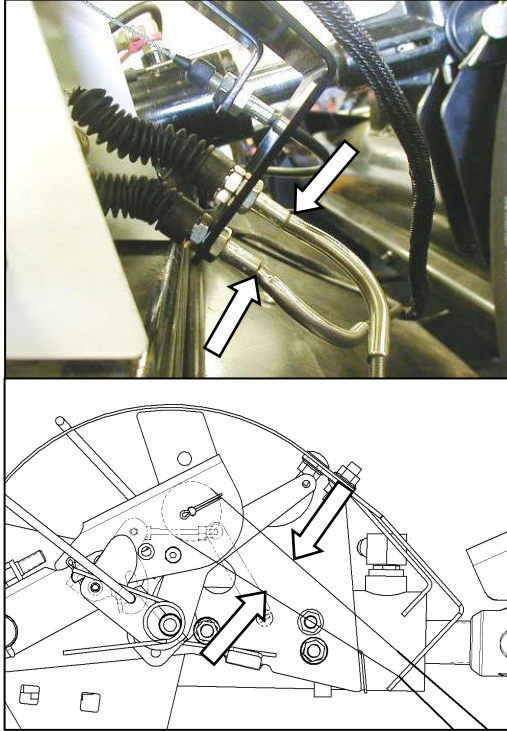

- m. Attach cables for auto header height onto bracket. Ensure cables are on pulley and are not crossed.

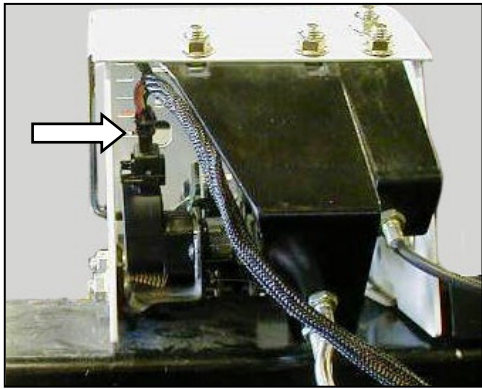

- n. Plug in the wiring harness for the Auto Header Height Control.

## SECTION III. ASSEMBLY - EXPORT

### STEP 2. REPOSITION GEARBOX

- a. Reposition hoses at pumps from shipping configuration to working configuration as follows:

#### IMPORTANT

Failure to properly route hoses may result in damage and premature failure of hoses.

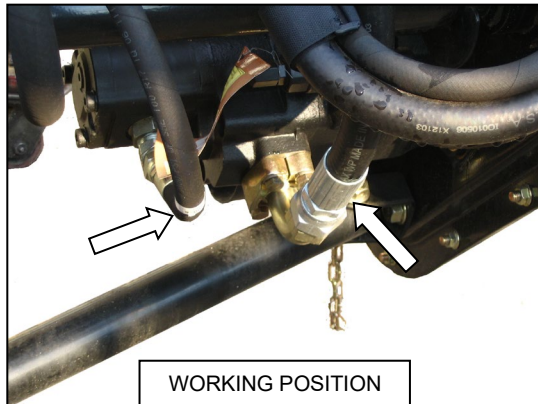
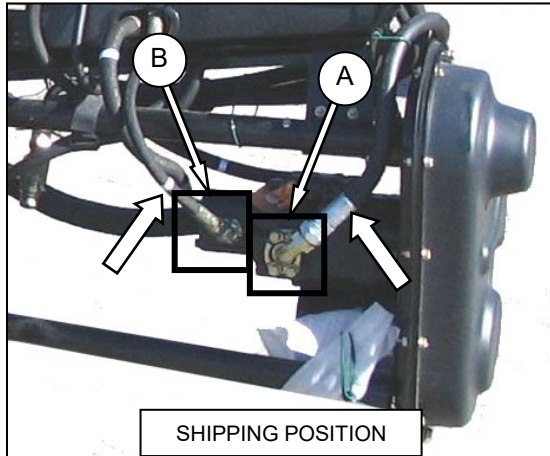

1. Loosen four bolts at fitting (A), and swivel hose to working position as shown. Tighten bolts.
2. Loosen fitting (B), and swivel hose to working position as shown. Tighten fitting.

#### NOTE

*If JIC to ORB fittings are used, loosen JIC nut, swivel hose to working position, and then tighten nut.*



- b. Remove shipping wire and wrapping on brace, and swing brace (C) clear of gearbox.



- c. Loosen nut (D), and move bolt out of shipping position slot.

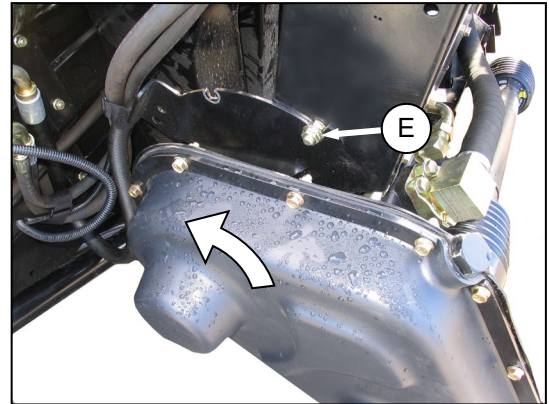

- d. Rotate gearbox, and move bolt into working position slot (E). Tighten nut.
- e. Remove bolt and nut from bracket on gearbox.

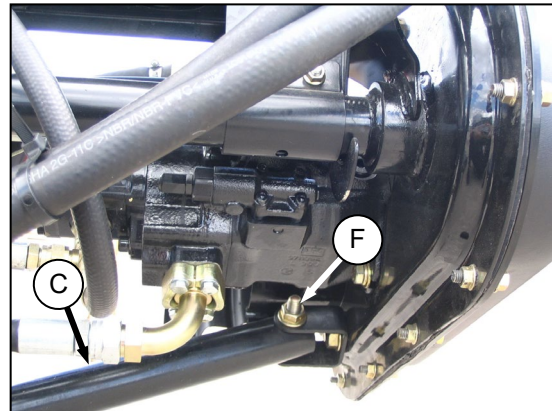

- f. Position brace (C) inside bracket, and re-install bolt (F) and nut.

## SECTION III. ASSEMBLY - EXPORT

### STEP 3. INSTALL FLOAT LINKS

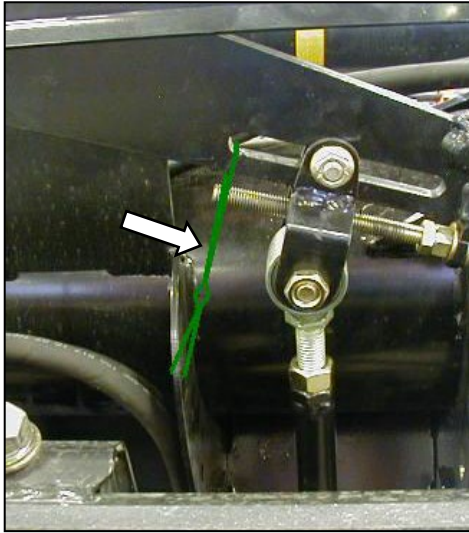

- a. Remove the shipping wire from bell crank.



- b. Remove pre-installed bolt, washers, and nut from bell crank. Discard washers (used to retain bushing for shipping).

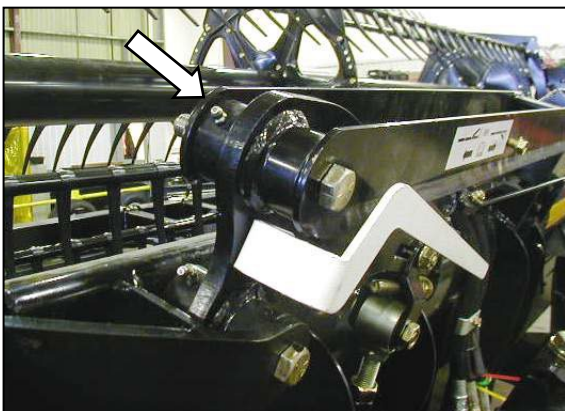

- c. Remove shipping wire from center-link, and install center-link to bell crank support with hex bolt and nut provided. Torque to 200 ft·lbf (N·m).

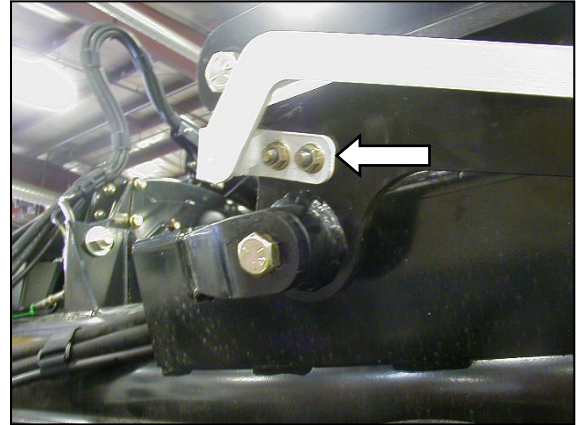

- d. Install white indicator to bell crank support with hardware pre-installed in bell crank.

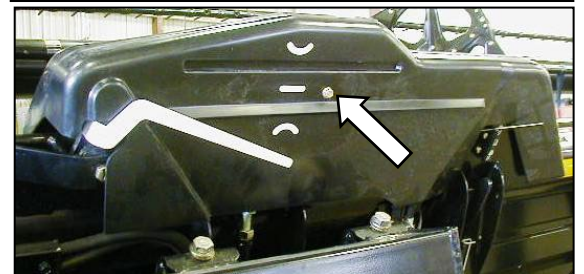
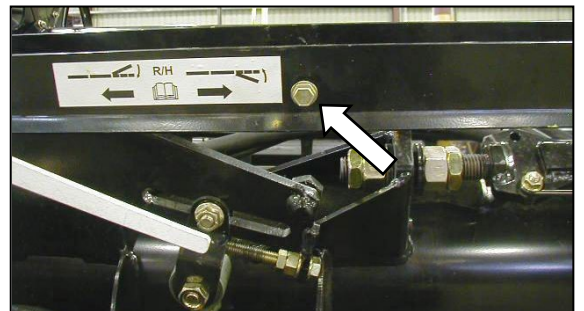

- e. Remove bolt from center-link, install float linkage cover and re-install bolt to secure cover.  
f. Repeat above steps a. to e. for opposite side.

## SECTION III. ASSEMBLY - EXPORT

### STEP 4. INSTALL REEL SPEED SENSOR

#### NOTE

*This step is not applicable to CASE/CNH combines. Proceed to **STEP 5. INSTALL OPTIONS** below.*

#### IMPORTANT

Except for Lexion combines, sensors are not supplied with MacDon Combine Adapters having Serial Numbers earlier than 177626\_07. Sensors need to be purchased as per the following:

COMBINE	SENSOR PART NO,
JOHN DEERE - ALL	John Deere #AH116104 & Two Nuts #H104418
AGCO - ALL	AGCO #71 391 021

Refer to **SECTION II. STEP 2. INSTALL REEL SPEED SENSOR.**

### STEP 5. INSTALL OPTIONS

Retrieve kits supplied as options with the header, and install in accordance with installation instructions supplied in each kit.

### SECTION III. ASSEMBLY - EXPORT

#### STEP 6. ATTACH REEL LIFT CYLINDERS

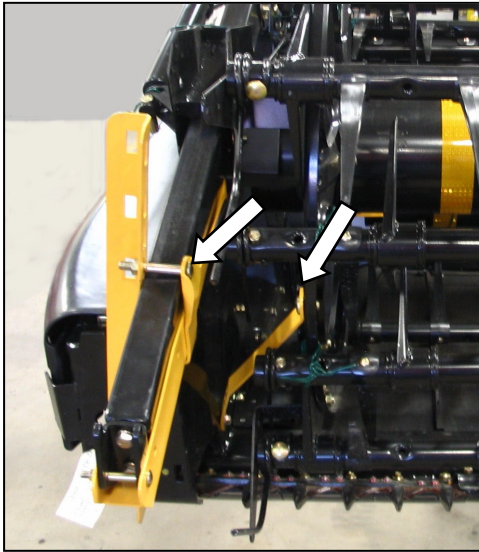

- a. Remove top bolt on outboard reel arm supports and remove reel anti-rotation brace.

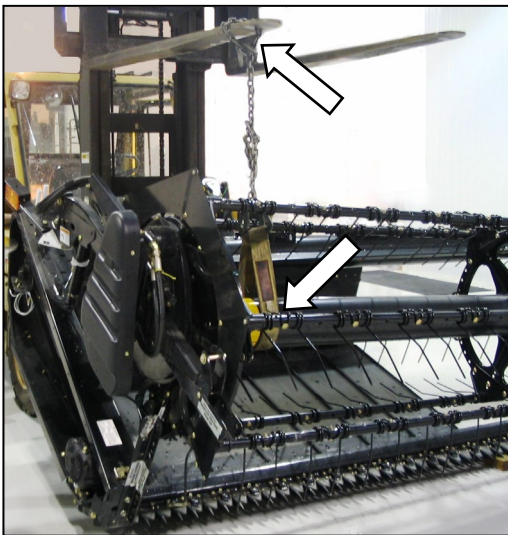

- b. Position sling around the reel tube close to outboard end of reel, and attach sling to a forklift (or equivalent).  
c. Lift reel so that reel lift cylinder can be installed.

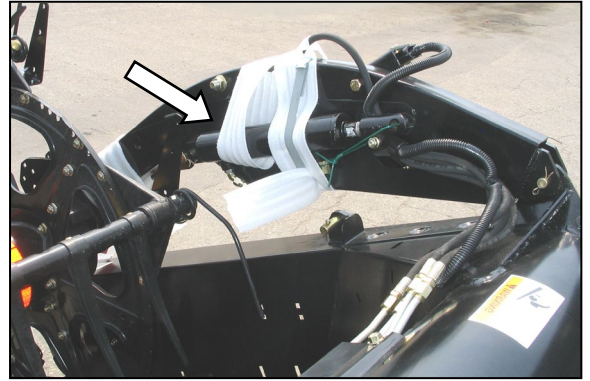

- d. Remove shipping wire/banding from cylinder.

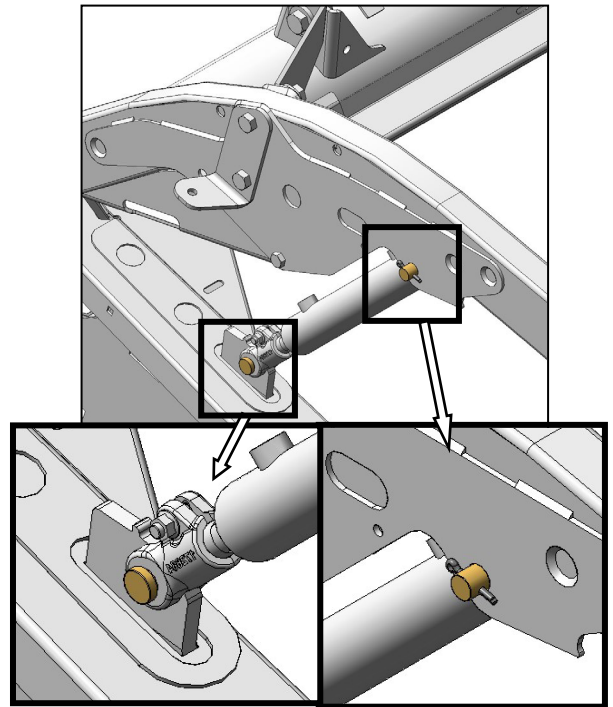

- e. Remove pins from reel arm. Secure cylinder to endsheet and reel arm with pins as shown. Secure with cotter pins.

*(continued next page)*

### SECTION III. ASSEMBLY - EXPORT



- f. Remove sling and reposition around reel tube near reel center support arm.
- g. Lift reel slightly to take weight off reel center arm support.

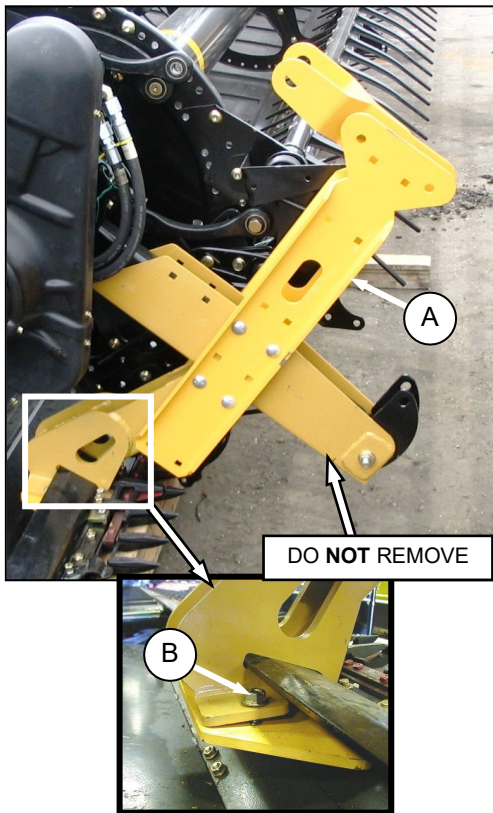

- h. Remove the two support channels (A) at the reel center arm. Do **not** remove support on reel arm.
- i. Remove bolt (B) at top of lower support and slide lower support off cutterbar.

- j. Lift reel so that reel center lift cylinder mounting holes line up with bracket on frame.



- k. Remove shipping wire/banding from cylinder and remove pin from frame. Secure cylinder to frame with pin as shown. Secure with cotter pin.

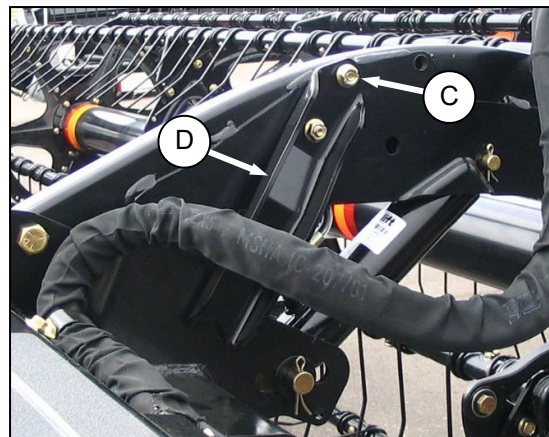

- l. At center reel arm, remove bolt (C), lower the reel prop (D), and reinstall bolt through same hole in arm, reel prop and hose clamp.
- m. Remove sling and reposition around reel tube near opposite outboard reel arm.
- n. Lift reel so that reel lift cylinder can be installed.
- o. Remove shipping wire/banding from cylinder.
- p. Remove pins from reel arm.

*(continued next page)*



### SECTION III. ASSEMBLY - EXPORT

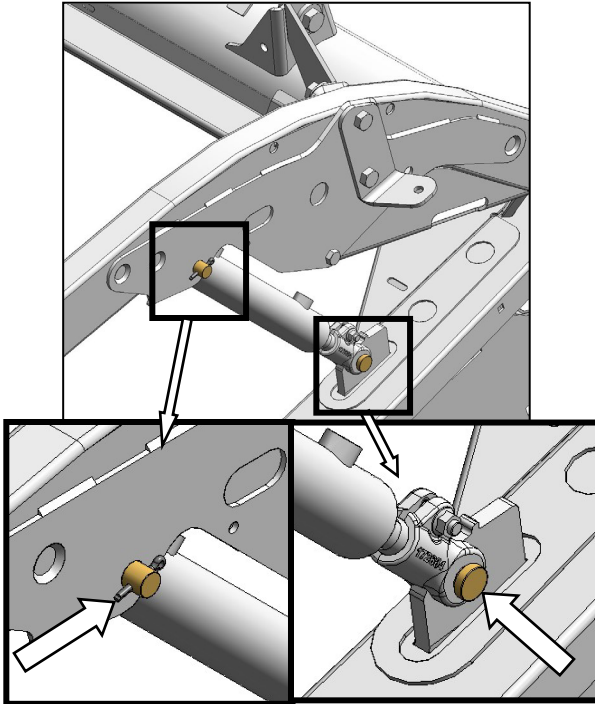

- q. Secure cylinder to endsheet and reel arm with pins as shown. Secure with cotter pins.

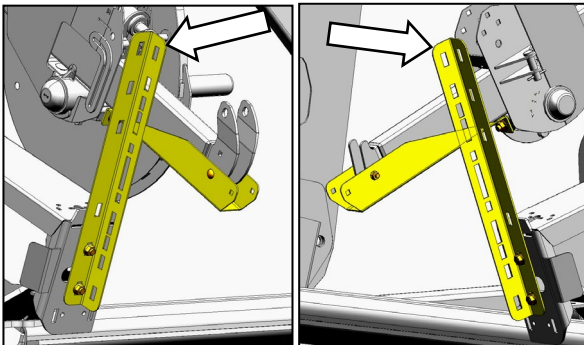

- r. Remove the two reel arm supports from endsheets. DO NOT REMOVE BRACES ON REEL ARMS.

## SECTION III. ASSEMBLY - EXPORT

### STEP 7. ATTACH CAM ARMS

#### NOTE

The upper tine bar may have been collapsed at the factory for shipping purposes.

- a. If necessary, re-attach supports to reel discs for the upper tine bar as follows:

1. Remove shipping wire from supports.

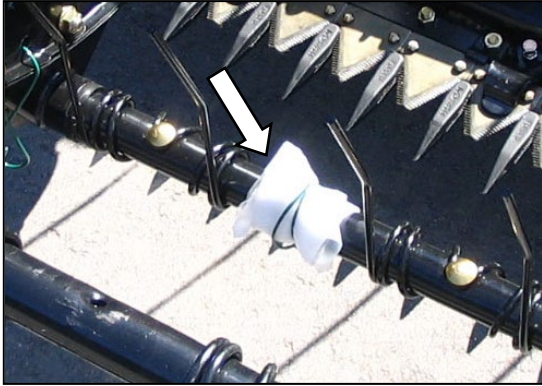

2. Retrieve bag of hardware from tine bar.
3. Reposition tine bar to align support attachment holes with disc.

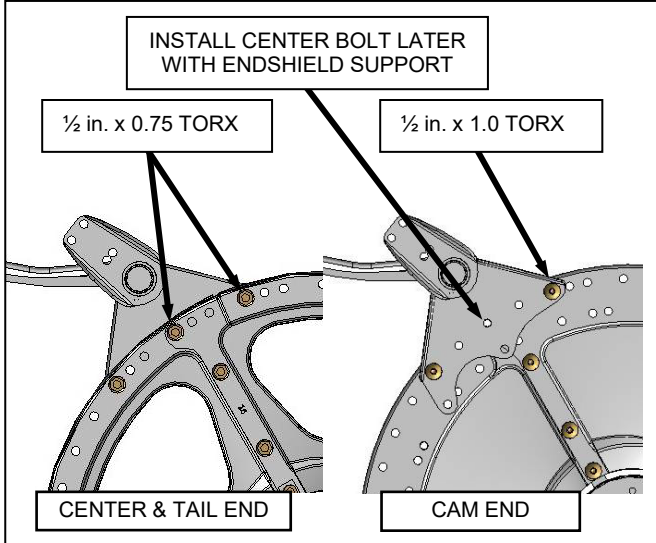

4. Secure supports to discs as shown with bolts and nuts provided in bag.
  5. Torque bolts to 70 - 80 ft·lbf (95 - 108 N·m).
- b. Manually rotate reel until the tine bars with the disconnected cam links are accessible.

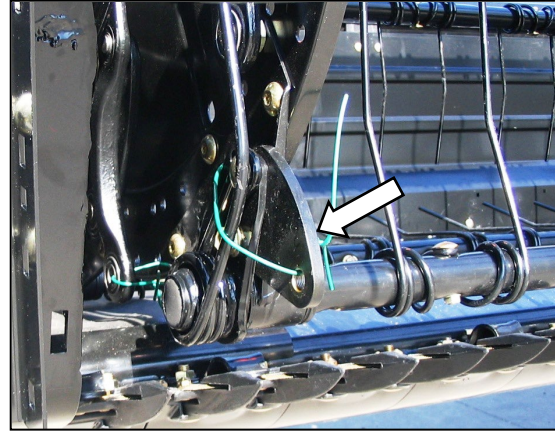

- c. Remove shipping wire if not already removed.

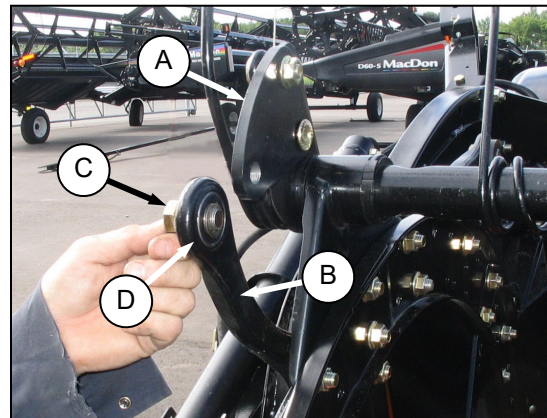

- d. Rotate tine bar crank (A), and position link (B) until attachment holes in bar crank and link are approximately aligned.
- e. Install bolt (C) in link and position shim (D) on bolt so that shim is between link (B) and tine bar crank (A).

#### NOTE

Bolts are pre-coated with Loctite so no further locking method is required.

- f. Realign link and tine bar crank and thread in the bolt (C).
- g. Repeat for remaining tine bars and torque bolts to 120 ft·lbf (165 N·m).

## SECTION III. ASSEMBLY - EXPORT

### STEP 8. INSTALL REEL ENDSHIELDS

Endshields on each end of some reels were removed for shipping purposes. If necessary, re-install shields as follows:

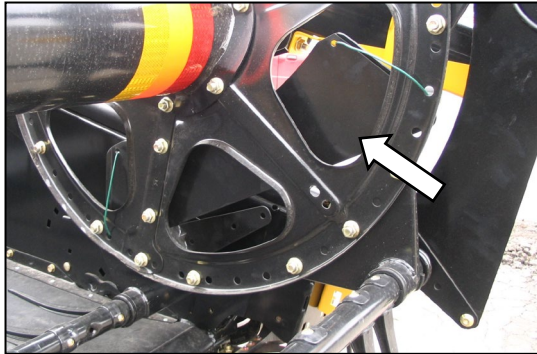

- Manually rotate reel until the wired endshields are accessible. Remove endshields.
- Manually rotate reel for accessibility to re-install the shields.

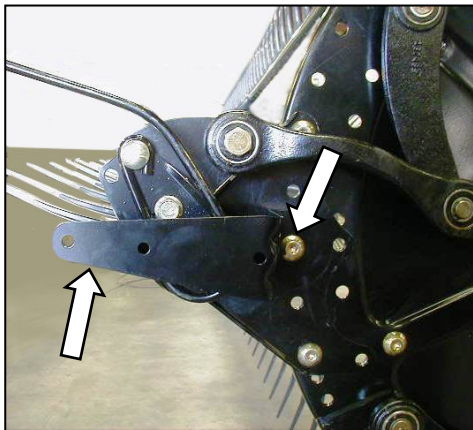

- If supports are installed, loosen bolts securing endshield supports to disc and rotate supports approximately as shown.

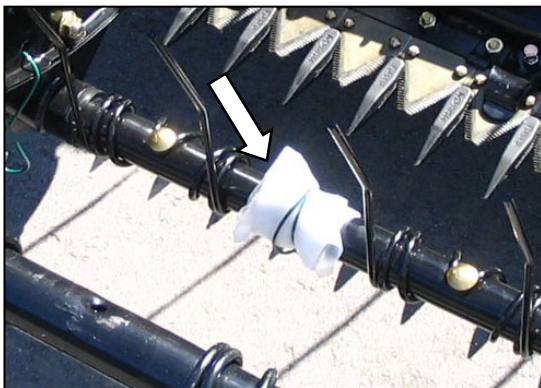

- Retrieve hardware from bag removed in **STEP 7. ATTACH CAM ARMS.**

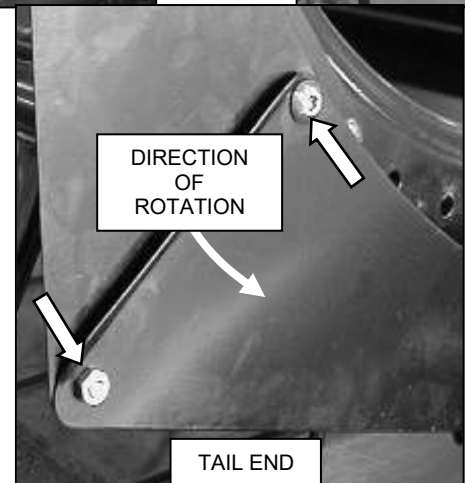
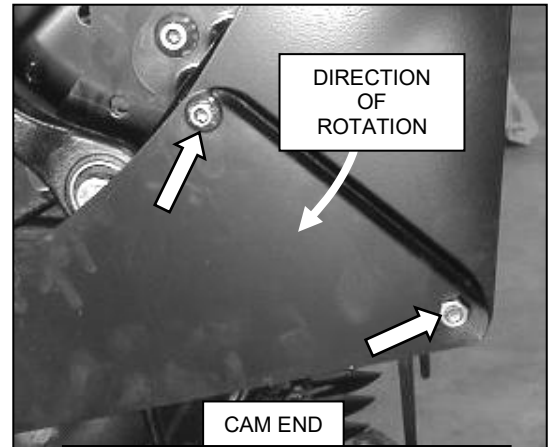

- Install endshields with lip in relation to reel rotation. Use 3/8 in. x 0.5 long Torx head screws and torque to 20 ft·lbf (27 N·m). **See photos for hardware orientation.** The jam nuts must be locking jam nuts. If they are not locking nuts, use Loctite® #243 (or equivalent)
- Re-tighten endshield support bolts.

*(continued next page)*

### SECTION III. ASSEMBLY - EXPORT

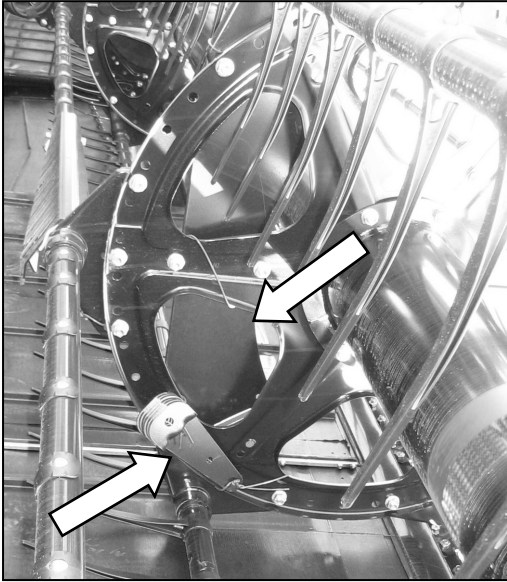

- g. If supports are not installed, retrieve supports and endshields that are wired to the reel disc.

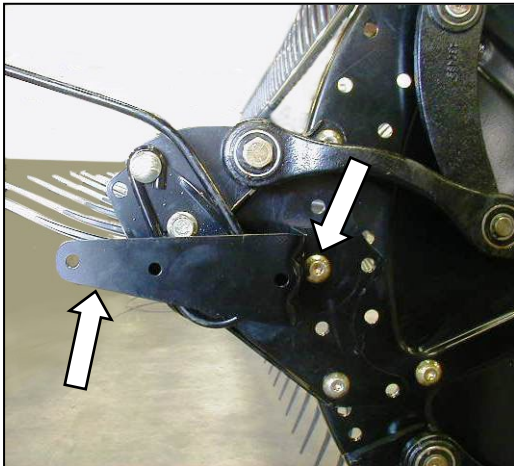

- h. Install endshield supports on disc as shown at each tine bar location, with hardware provided in bag.
- i. Install endshields. See step e. on previous page.

## SECTION III. ASSEMBLY - EXPORT

### STEP 9. INSTALL CENTER FORE-AFT CYLINDER

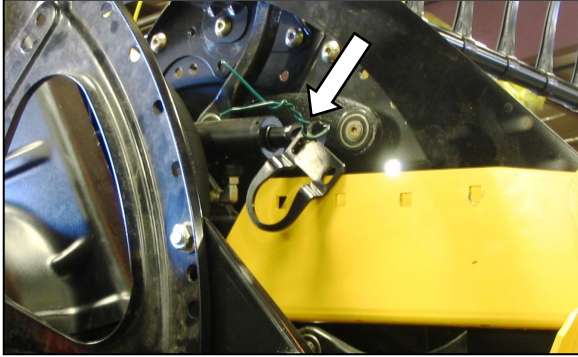

- a. At reel center arm, if fore-aft cylinder is secured with shipping wire, proceed as follows, otherwise proceed to **STEP 12. CONNECT FORE-AFT CYLINDERS.**

1. Remove shipping wire and clip from cylinder rod end.

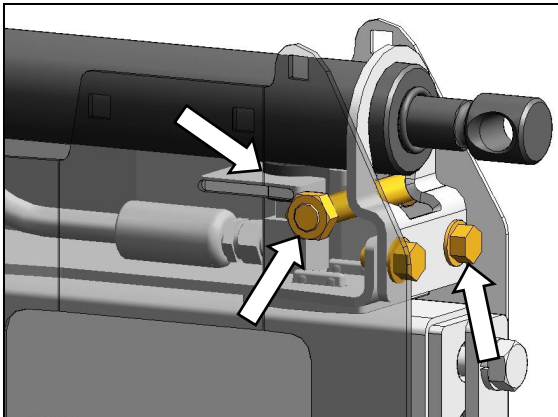

2. Remove the two 3/8 in. x 0.62 long hex screws and one 1/2 in. x 3.5 long hex bolt and nut.
3. Position cylinder so that cylinder port locates in hole in cylinder cradle. Reinstall 1/2 in. x 3.5 long hex bolt and nut.
4. Position clip on cylinder as shown and install with the two 1/2 in. x 3.5 hex bolts and nuts. Tighten hardware.

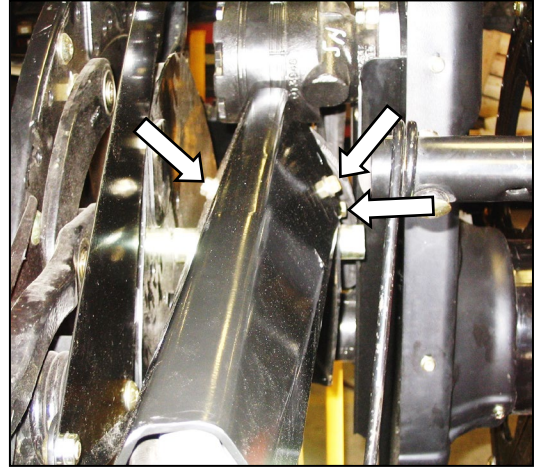

- b. Install cover over center hoses of reel fore-aft cylinder with three 3/8 in. x 0.62 long hex screws provided.

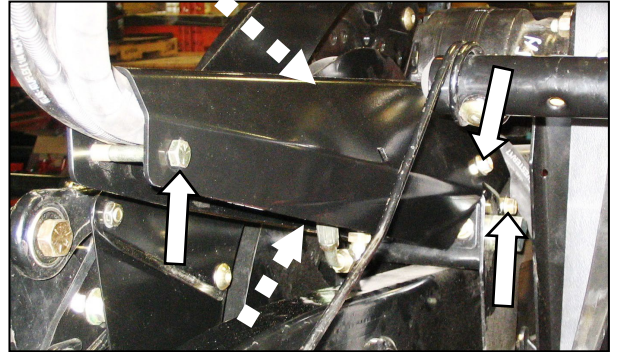

- c. Locate hoses in cover and install one 3/8 in. x 2.75 long bolt and nut provided.

#### IMPORTANT

Leave sufficient hose behind the cover to allow reel to move fully forward.

### STEP 10. SET-UP ADAPTER

Refer to **SECTION II. STEP 4. SET-UP ADAPTER.**

### STEP 11. ATTACH TO COMBINE

Refer to **SECTION II. STEP 5. ATTACH TO COMBINE.**

### SECTION III. ASSEMBLY - EXPORT

## STEP 12. CONNECT FORE-AFT CYLINDERS



### CAUTION

The reel fore-aft hydraulic cylinders must be connected to the reel prior to removing the fore-aft supports. Failure to do so may result in the reel sliding full forward when the supports are removed.



### CAUTION

Reel arms must be level prior to removing reel shipping braces. Failure to do so may result in reel moving suddenly.



### CAUTION

Be sure all bystanders are clear of machine before starting engine or engaging any header drives.

- Remove shipping wire and pins from fore-aft cylinders. Pin may be installed in arm. One cylinder on each reel support arm.
- Start combine, and level the reel arms with the combine hydraulics.
- Extend and retract fore-aft cylinders to re-phase cylinders.
- Align cylinders with reel arm mounting holes with combine hydraulics. Stop engine and remove key.
- Attach fore-aft cylinders to reel arms with clevis pins, washers, and cotter pins as shown.

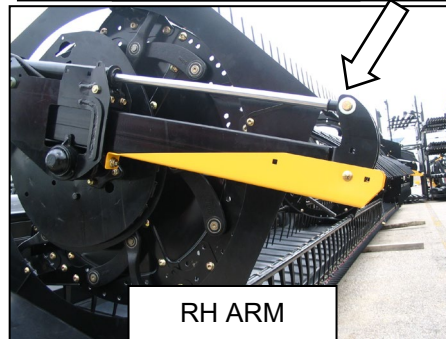
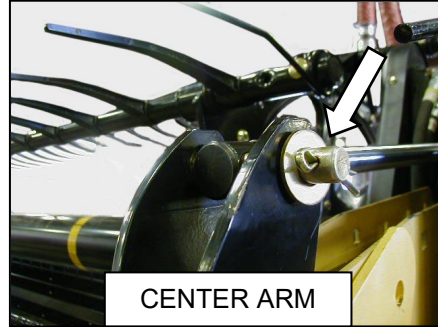
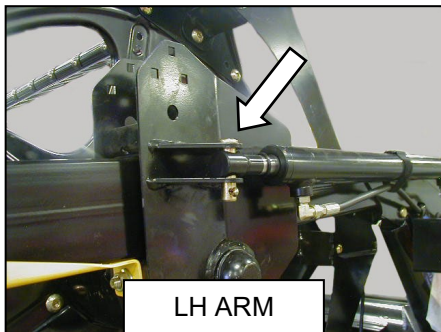

- f. Remove supports on reel arms.

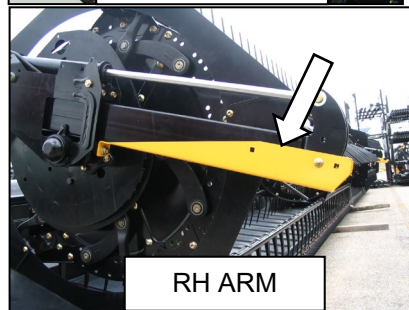
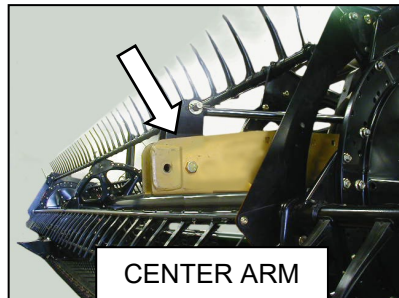
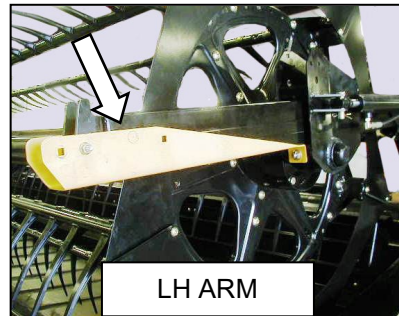

### SECTION III. ASSEMBLY - EXPORT

#### STEP 13. INSTALL CROP DIVIDERS

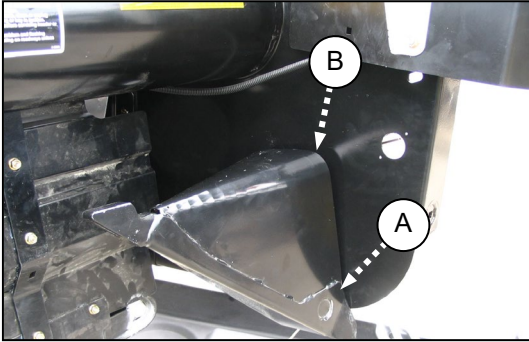

- a. At divider storage location, lift divider to disengage lugs (A) at lower end, and then lower it slightly to disengage pin (B) from endsheet.

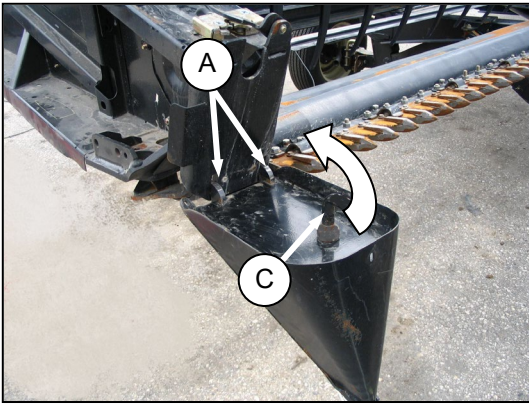

- b. Position crop divider as shown by locating lugs (A) in holes in endsheet.

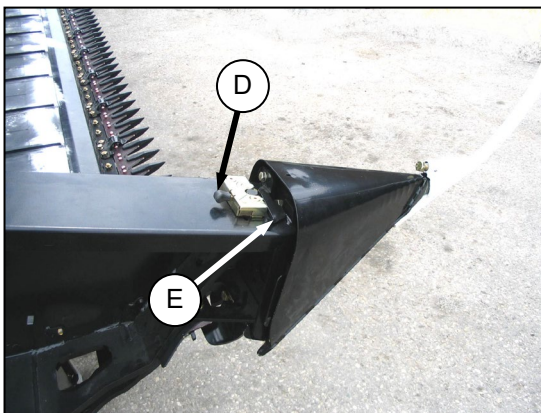

- c. Lift forward end of divider until pin (C) at top of divider engages and closes latch (D).  
d. Push safety lever (E) down to lock pin in latch.

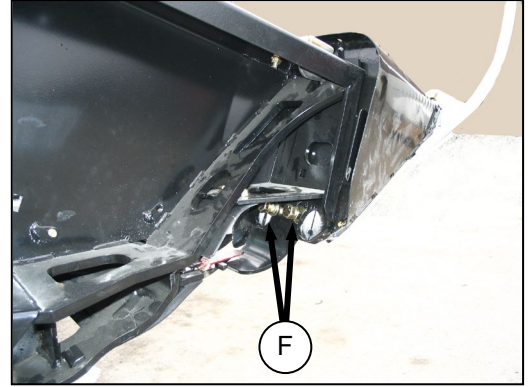

- e. Check that divider does not move laterally. Adjust bolts (F) as required to tighten divider and remove lateral play when pulling at divider tip.



- f. Remove divider rods from storage location on header endsheet.

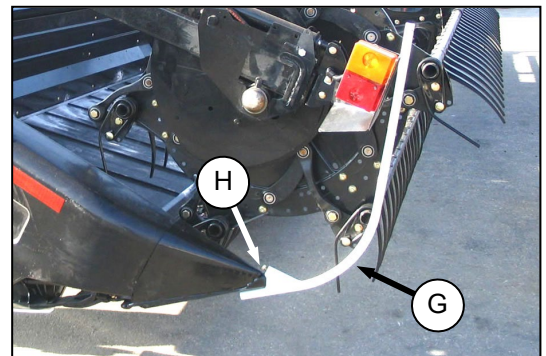

- g. Position divider rod (G) on tip of crop divider as shown and tighten bolt (H).

## SECTION III. ASSEMBLY - EXPORT

### STEP 14. TRIM DRAPER DEFLECTORS

Refer to Section II. STEP 9. TRIM DRAPER DEFLECTORS.

### STEP 15. INSTALL KNIFE HEAD SHIELDS

Refer to Section II. STEP 10. INSTALL KNIFE HEAD SHIELDS.

### STEP 16. POSITION TRANSPORT LIGHTS



Position light perpendicular to header. Lights are located on each of the outboard reel arms.

### STEP 17. PRE-DELIVERY CHECKS

Refer to SECTION IV. PRE-DELIVERY CHECKS.



## SECTION IV. PRE-DELIVERY CHECKS

### SECTION IV. PRE-DELIVERY CHECKS



#### WARNING

Stop combine engine and remove key before making adjustments to machine. A child or even a pet could engage the drive.

#### IMPORTANT

To avoid machine damage, check that no shipping dunnage has fallen into machine.

- a. Perform the final checks as listed on the "**Pre-Delivery Checklist**" (yellow sheet attached to this instruction) to ensure the machine is field-ready. Refer to the following pages for detailed instructions as indicated on the checklist.

#### IMPORTANT

The machine has been set at the factory and should require no further adjustments. However, perform the following checks to ensure your machine will provide maximum performance. Adjustments should be made only if absolutely necessary, and in accordance with the instructions in this manual.

- b. The completed checklist should be retained either by the operator or the dealer.

#### A. TIRE PRESSURE - SLOW SPEED TRANSPORT AND STABILIZER WHEEL OPTIONS

Check tire inflation pressure. If necessary, inflate as per following table.

YR	TIRE	SIZE	PRESSURE
2006 & EARLIER	GOODYEAR WRANGLER RT/S	205-75 R15	40 psi (276 kPa)
2007 to 2009	CARLISLE & TITAN	ST205/75 R15	65 psi (448 kPa)
2010 & LATER	DICO	ST205/75 R15	LR "D" 65 psi (448 kPa)
			LR "E" 80 psi (552 kPa)

#### IMPORTANT

Do not exceed maximum pressure specified on tire sidewall.

#### B. WHEEL BOLT TORQUE - SLOW SPEED TRANSPORT AND STABILIZER WHEEL OPTIONS

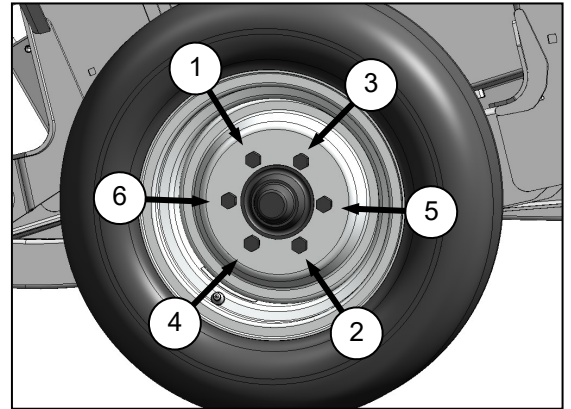

Check wheel bolt torque is 80 - 90 ft-lbf (110 -120 N·m). Refer to bolt tightening sequence illustration.

#### C. WOBBLE BOX

For access to the wobble box(es), the endshield(s) must be opened.

- a. To open endshield(s), press against latch in opening at (A) on inboard side of endsheet.

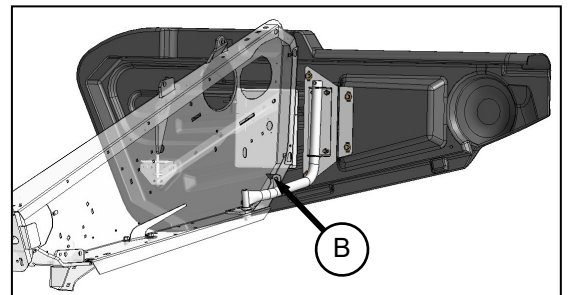
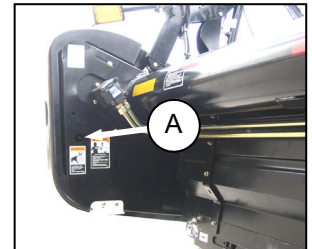

- b. Pull shield away from header and swing it out and back behind the endsheet until the latch (B) engages the hook on the endsheet.

*(continued next page)*

## SECTION IV. PRE-DELIVERY CHECKS

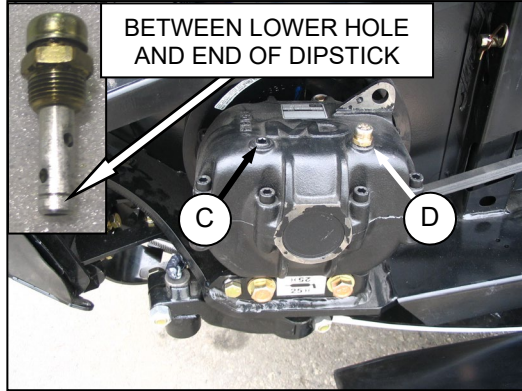

CHECK OIL LEVEL WITH TOP OF WOBBLE BOX HORIZONTAL

- c. Position of plug (C) and breather (D) at wobble box must be as shown.
- d. Check oil level.
- e. Leave endshield(s) open.

### D. GEARBOX OIL

- a. Set cutterbar to working position.

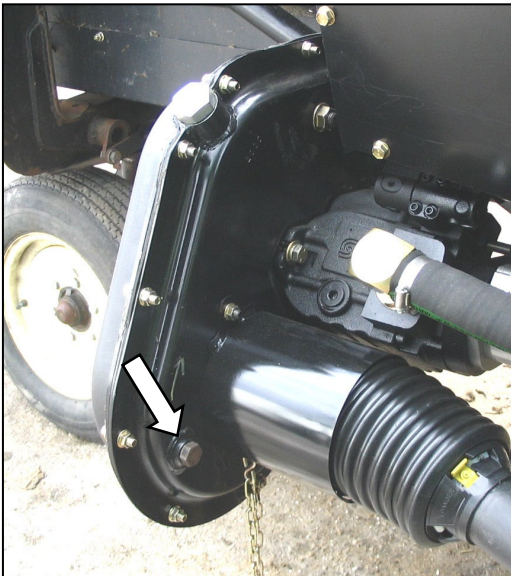

- b. Remove drain plug. Level should be to bottom of drain hole.

### E. HYDRAULIC RESERVOIR

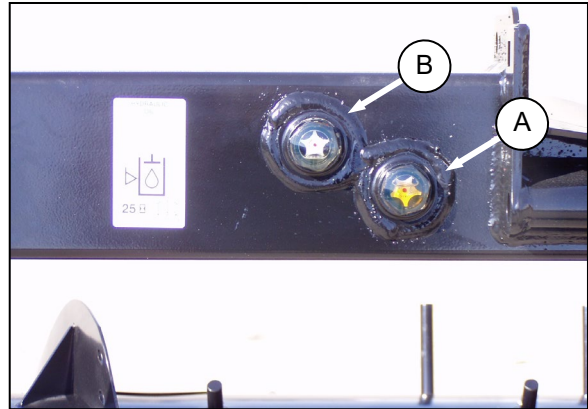

Check oil level at sights (A) and (B) with cutterbar just touching ground. Check when oil is cold and with center-link retracted.

Nominal – Normal Terrain: Maintain level so lower sight (A) is full and upper sight (B) is empty.

#### NOTE

*When ambient temperatures are above 95° F (35° C), to prevent overflow at breather under operating temperatures, it may be necessary to lower oil level slightly.*

## SECTION IV. PRE-DELIVERY CHECKS

### F. SICKLE BELT TENSION

#### NOTE

The sickle drive is identical on both sides of the header.

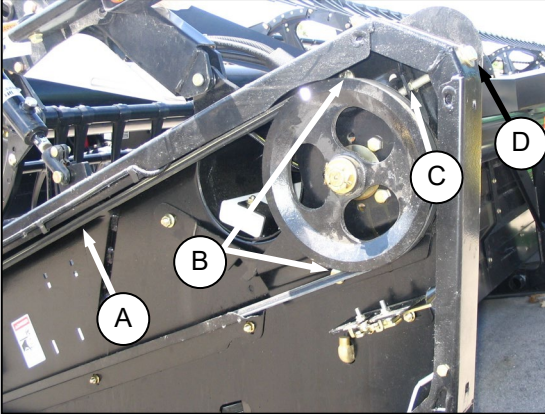

- A force of 20 lbf (80 N) should deflect belt (A) 3/4 in. (18 mm) at mid-span.
- If necessary, adjust tension as follows:
  - Loosen two bolts (B) on sickle drive mounting bracket and jam-nut (C).
  - Turn adjuster bolt (D) to move drive motor until tension is achieved.
  - Tighten jam nut (C) and bolts (B) on drive mounting bracket.

### G. REEL CENTERING

- Raise header, shut down combine and engage header lift cylinder stops.

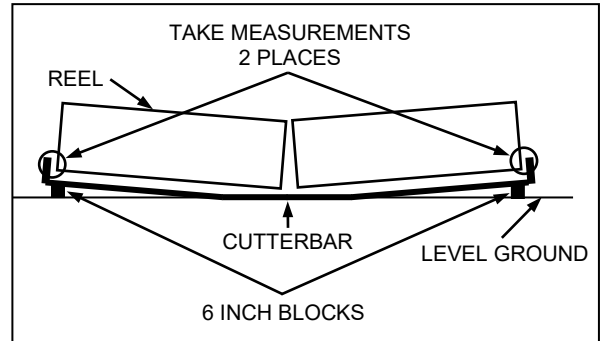

- Place two 6 inch (150 mm) blocks at ends of cutterbar.
- Disengage float locks and header lift cylinder locks.
- Start combine, and lower header fully, allowing it to flex into full smile mode.
- Shut down engine.



#### WARNING

**Stop /combine engine and remove key before making adjustments to machine. A child or even a pet could engage the drive.**

- Measure clearance between reels and both endsheets. The clearances should be the same if the reels are centered.
- If required center the reels as follows:

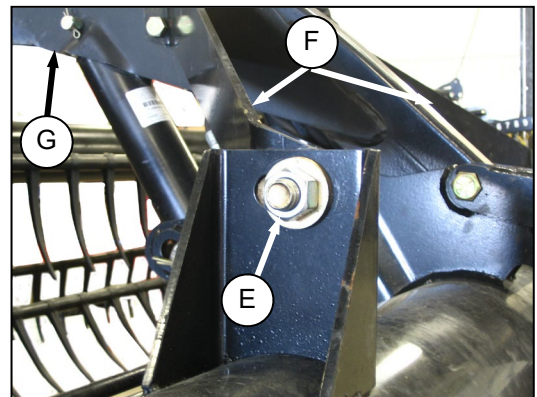

- Loosen bolt (E) on each brace (F).
- Move forward end of center support arm (G) laterally as required to center both reels.
- Tighten bolts (E) and torque to 265 ft·lbf (359 N·m).

## SECTION IV. PRE-DELIVERY CHECKS

### H. DRAPER TENSION

Raise header, and shut down engine. Engage header lift props.



#### WARNING

Stop combine engine and remove key before making adjustments to machine. A child or even a pet could engage the drive.



#### CAUTION

Engage header lift cylinder stops before working under header.

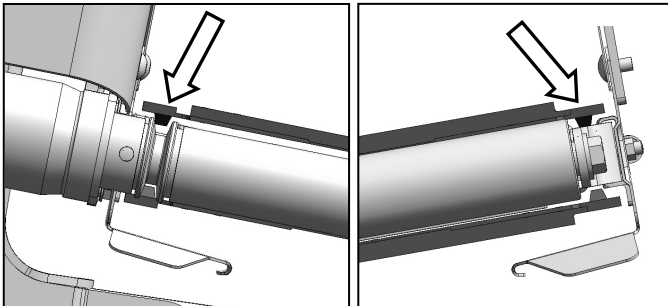

DRIVE ROLLER - ONE END

IDLER ROLLER - BOTH ENDS

- a. Check that draper guide (rubber track on underside of draper) is properly engaged in groove of drive roller, and that idler roller is between the guides.

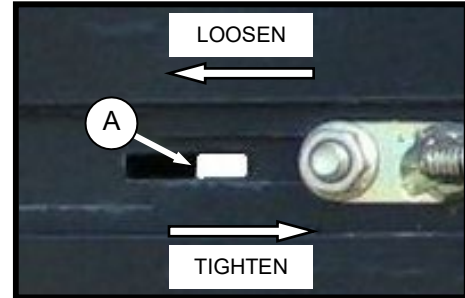
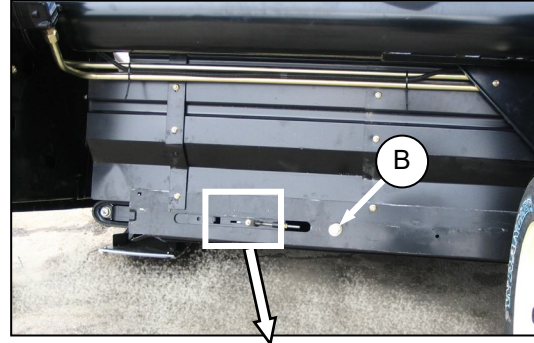

- b. Draper tension should be just enough to prevent slipping, and keep draper from sagging below cutterbar. The white bar (A) should be about halfway in the window.

If required, set draper tension as follows:

1. Turn bolt (B) clockwise (tighten) and white indicator bar (A) will move inboard in direction of arrow to indicate that draper is tightening.
2. Turn bolt (B) counter clockwise (loosen) and white indicator bar (A) will move outboard in direction of arrow to indicate that draper is loosening.
3. Adjust until bar is about halfway in window.

## SECTION IV. PRE-DELIVERY CHECKS

### I. HEADER MAIN FLOAT

#### I. CHECKING FLOAT



### CAUTION

Stop engine and remove key from ignition before leaving Operator's seat for any reason. A child or even a pet could engage an idling machine.

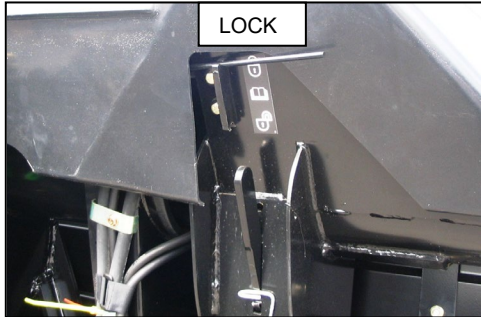

- a. Ensure both wing float locks are engaged.

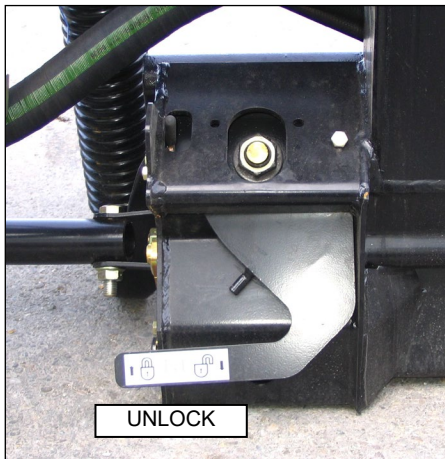

- b. Ensure both header float lock levers are down (UNLOCK).
- c. If header is equipped with stabilizer wheels or slow speed transport wheels, raise them off the ground so they are supported by the header.

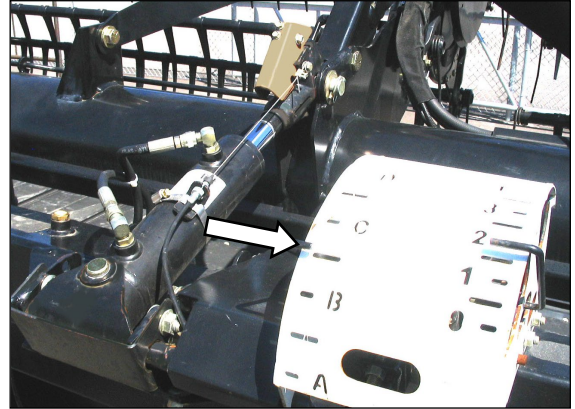

- d. Set center-link to mid-range (B to C on float/angle indicator if installed). Adjust cutterbar to 6 - 10 inches (150 - 250 mm) above the ground.

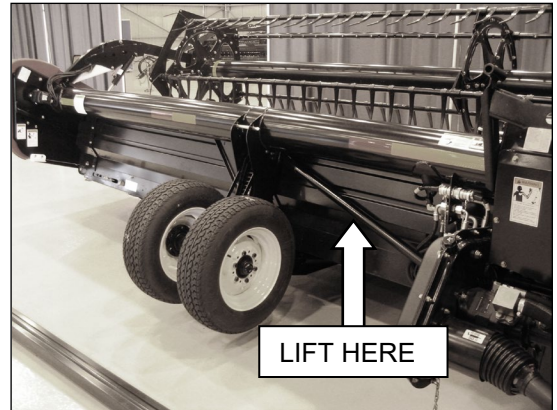

- e. Lift the header at the rear diagonal brace, or on the back-tube. The lifting force should meet the following criteria:
- If header will be operating with the cutterbar **on the ground**, the header should move up with approximately 75 lbf (334 N) force and then return to its original position.
  - If header will be mostly operating with the cutterbar **off the ground**, the float should be set heavier to minimize bouncing of the header.

Also see “**IMPORTANT**” notes that follow on the next page.

*(continued next page)*

## SECTION IV. PRE-DELIVERY CHECKS

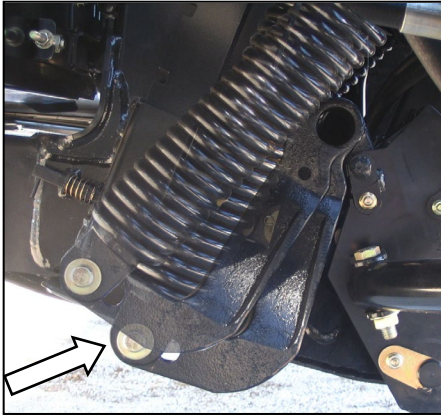

### NOTE

Check movement of bell cranks at base of adapter. They should move forward when the header is lifted and then return to the original position.

- f. If excessive force is required, or the header does not return to its original position, the float requires adjusting. See sub-section **II. ADJUSTING HEADER FLOAT**.

### IMPORTANT

To avoid frequent breakage of sickle components, scooping soil, or soil build-up at cutterbar in wet conditions, header float should be set as light as possible without causing excessive bouncing. When float setting is light, it may be necessary to use a slower ground speed to avoid excessive bouncing and leaving a ragged cut.

### NOTE

If adequate header float cannot be achieved using all of the available adjustments, an optional heavy duty spring is available. It includes an inner spring. See your MacDon Dealer or Parts Catalog for ordering information.

## II. ADJUSTING HEADER FLOAT

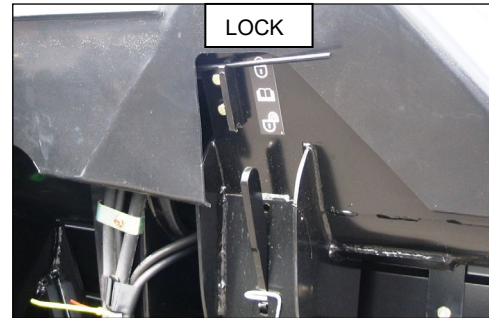

- a. Ensure both wing float locks are engaged.

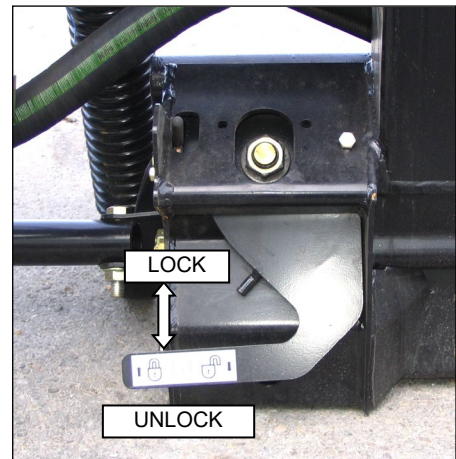

- b. Ensure both header float lock levers are down (UNLOCK).

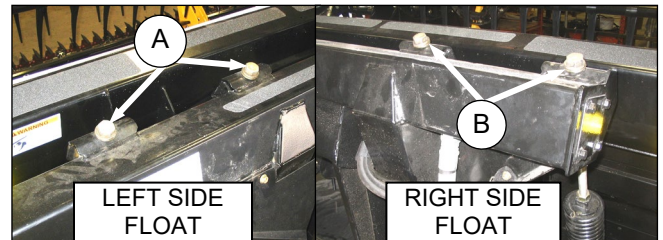

- c. Tighten bolts (A) and (B) at both sides of adapter to increase float (lightens the header).  
d. Loosen bolts to decrease float (increases header weight).

### IMPORTANT

- Turn each bolt pair equal amounts.
- e. The float is properly adjusted when:
- for **30, 35, and 40 foot single knife**: Both sides of the header are adjusted to the same weight (approximately 75 lbf (334 N)).
  - for **40 and 45 foot double knife**: RH side is slightly heavier (loosen RH side adjuster bolts (B) by 2 turns).

## SECTION IV. PRE-DELIVERY CHECKS

### J. TRIM SPRINGS

Check as follows that the float trim springs are properly installed:

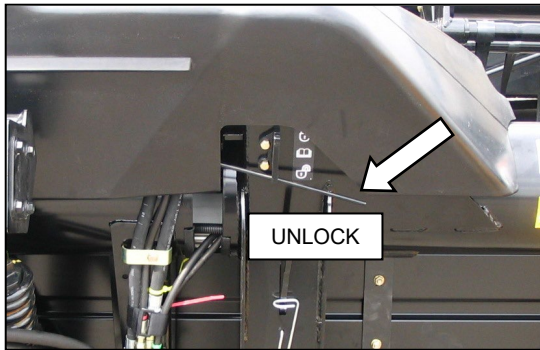

- a. Place spring handle in the lower slot to UNLOCK.

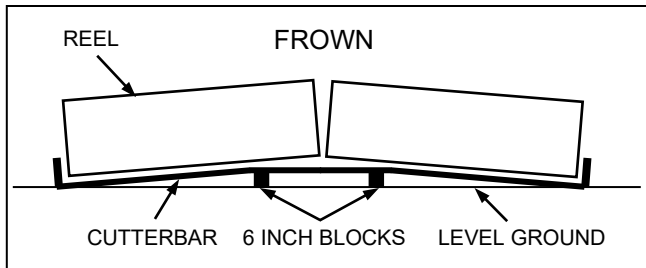

- b. Place 6 inch (150 mm) blocks under hinge area of cutterbar  
c. Start combine, and fully retract tilt cylinder.  
d. Lower header onto blocks so that header goes into a full frown, OR  
e. Position cutterbar approximately 6 in. (150 mm) off the ground.  
f. Shutdown combine.

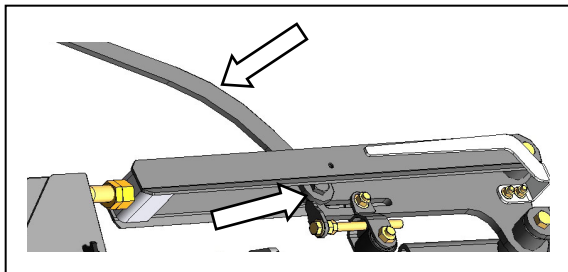

- g. Use special wrench on bolt head to frown the wings one at a time

#### NOTE

*Wrench is located in RH header leg beneath spring handle.*



### WARNING

Stop combine engine and remove key before making adjustments to machine. A child or even a pet could engage the drive.

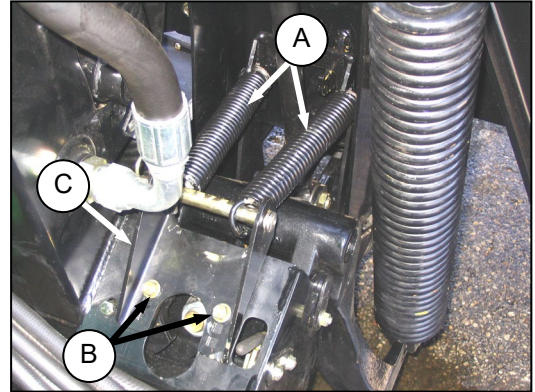

- h. Check that trim springs (A) are loose (no tension or compression) when the wings are in frown position.  
i. If necessary, remove bolts (B) and relocate rear trim spring bracket (C) in a different hole so that that springs are loose when tilt cylinder is fully retracted and header is in full frown.

## SECTION IV. PRE-DELIVERY CHECKS

### K. WING FLOAT LOCK ADJUSTMENT (CUTTERBAR ALIGNMENT)

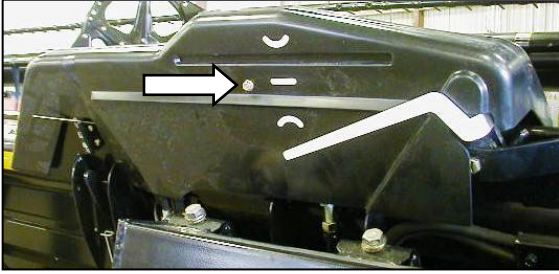

- a. Remove screw and remove linkage cover on the side that needs adjustment.

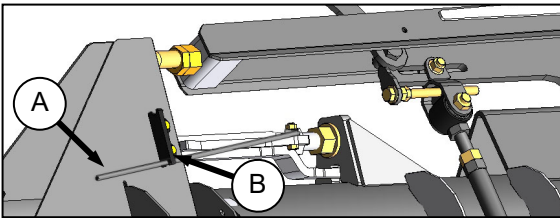

- b. Unlock the wing float by moving handle (A) to lower UNLOCK position (B).
- c. Support the header so that the cutterbar is straight by either lowering on level ground or on blocks that are even.

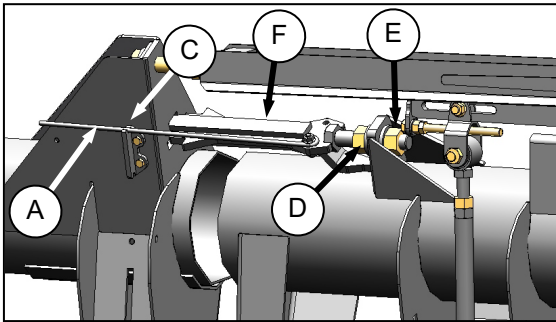

- d. Lock the wing float by moving handle (A) to the upper LOCK position (C).
- e. Loosen nut (D) and (E) and adjust so that lock link (F) freely moves out of and into the upper LOCK position.
- f. Tighten nuts (D) and (E) against spacer to 150 ft·lbf (200 N·m).
- g. Replace linkage cover.
- h. If a wing has a tendency to be in a smile or frown position, the wing balance may require adjusting. Refer to sub-step L. *WING BALANCE*.



## SECTION IV. PRE-DELIVERY CHECKS

### L. WING BALANCE

If a wing has a tendency to be in a smile or frown position, the wing balance may require adjusting. Check and balance the header wings as follows:



### WARNING

**Stop combine engine and remove key before making adjustments to machine. A child or even a pet could engage the drive.**

- Extend the header angle hydraulic cylinder 2 - 3 in. (50 - 75 mm) from fully retracted.
- Raise header until cutterbar is 6 - 10 in. (152 - 254 mm) off the ground.
- Stop engine and remove key.

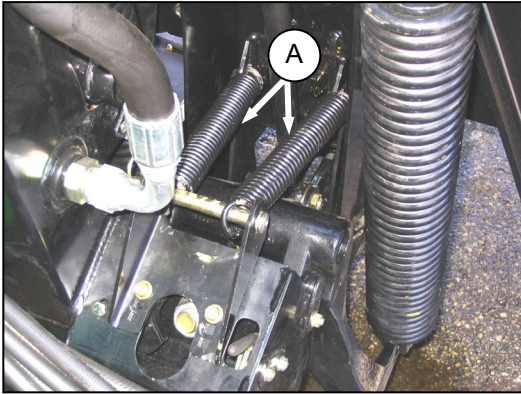

- Check that trim springs (A) are connected to the combine CA20 adapter.
- Move transport/stabilizer wheels so that they are supported by header. Refer to instructions provided with the transport/stabilizer wheel system.

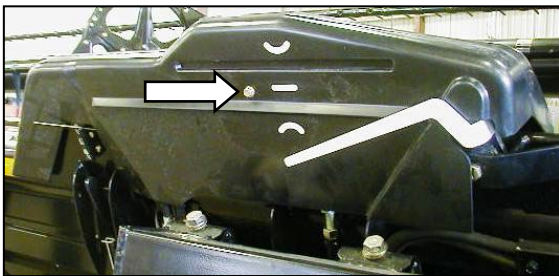

- Remove screw and remove linkage cover on the side that needs adjustment.

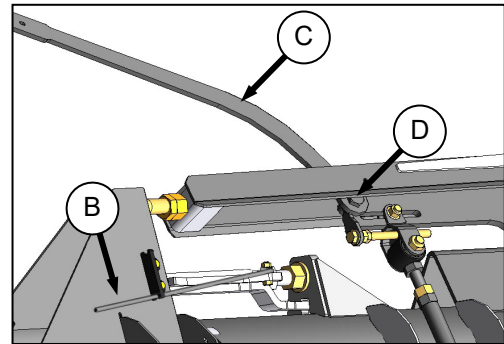

- Move spring handle (B) to lower position to UNLOCK the wing float.
- Place wrench (C) (in header leg) on bolt (D).

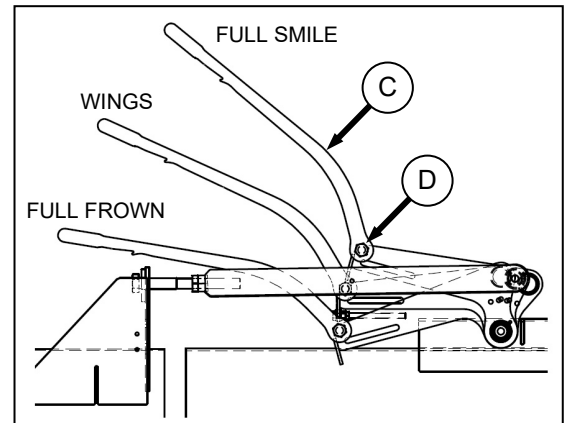

- Move each wing up and down with the wrench (C) to determine tendency of wing to 'smile' or 'frown'.
- Balance is set when the same effort is required to move the bell crank (wing) up or down, or the wing tends to align itself with the center cutterbar.

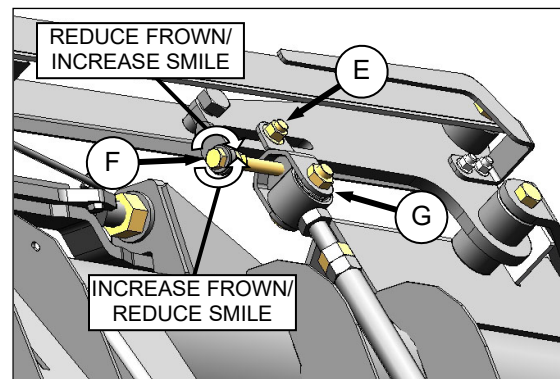

- If wing tends to 'smile' (stay up), loosen clamp-bolt (E) and turn draw-bolt (F) counter clockwise to move clevis (G) inboard to reduce the 'smile'.
- If wing tends to 'frown' (stay down), loosen clamp-bolt (E) and turn draw-bolt (F) clockwise to move clevis (G) outboard to reduce the 'frown'.
- Tighten clamp bolt (E)

*(continued next page)*

## SECTION IV. PRE-DELIVERY CHECKS

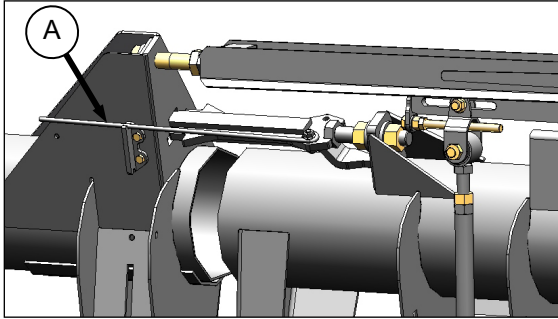

- n. Move spring handle (A) to upper position to LOCK the wing float.

### NOTE

*If the cutterbar is not straight when wings are in lock mode, then further adjustments are required. Refer to sub-step K. WING FLOAT LOCK ADJUSTMENT (Cutterbar Alignment).*

### NOTE

*Decals (N) and (O) are located on the center-link for each wing to indicate adjustments. Refer to illustration in opposite column for details.*

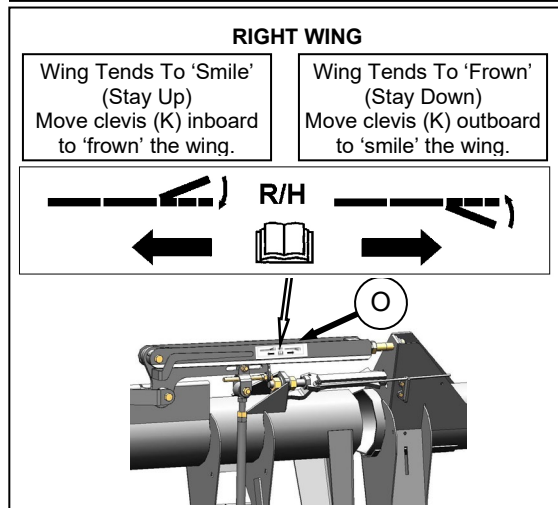
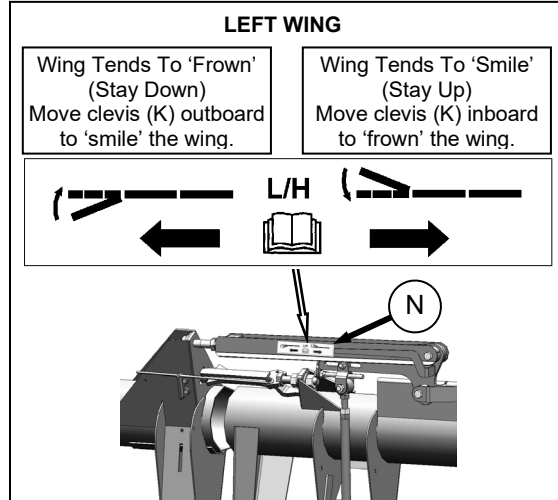

- o. Replace linkage cover and wrench.

## SECTION IV. PRE-DELIVERY CHECKS

### M. SKID SHOE SETTINGS



#### WARNING

Stop combine engine and remove key before making adjustments to machine. A child or even a pet could engage the drive.



#### CAUTION

Engage header lift cylinder stops before working under header.

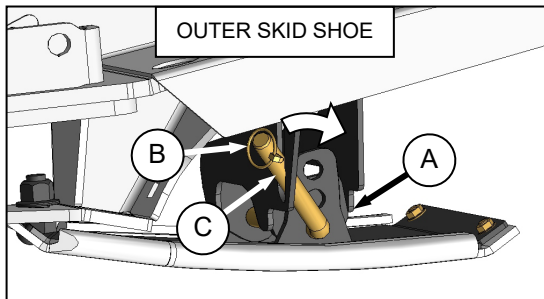
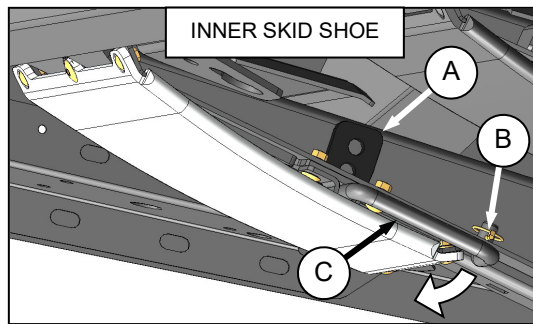

- a. Note the hole positions on the adjuster legs (A) on each skid shoe. They should be the same.
- b. If necessary, adjust as follows:
  1. Remove lynch pin (B).
  2. Hold shoe and remove pin (C) by disengaging frame and then pulling away from shoe.
  3. Raise or lower skid shoe to desired position using holes in support as a guide.
  4. Reinsert pin (C), engage in frame, and secure with lynch pin (B).
  5. Check that skid shoes are adjusted to the same position.

## SECTION IV. PRE-DELIVERY CHECKS

### NOTE

The reel has been adjusted at the factory to provide more clearance at the center of the reel than at the ends (frown) to compensate for reel flexing.

### N. REEL TINE TO CUTTERBAR CLEARANCE

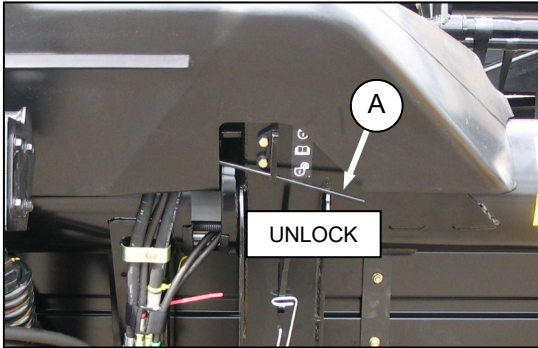

- a. Place spring handle (A) in lower slot to unlock the wings.



### CAUTION

Engage header lift cylinder stops before working under header.



### WARNING

Stop combine engine and remove key before making adjustments to machine. A child or even a pet could engage the drive.

- b. Raise header, shut down combine and engage header lift cylinder stops.

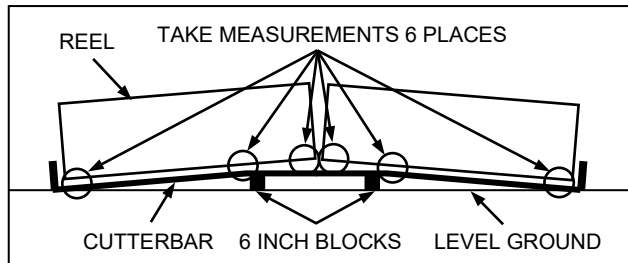

- c. Place two 6 inch (150 mm) blocks just inboard of wing flex points.
- d. Disengage header lift cylinder locks, Start combine, and lower header fully, allowing it to flex into full frown mode.

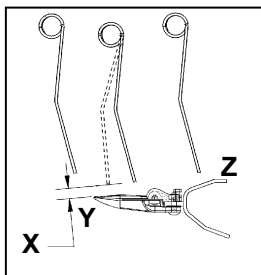

- e. Measure clearance 'X' at ends of each reel.

- f. Measure the clearance 'X' at both flex locations.
- g. Check all possible points of contact between points 'Y' and 'Z'. Depending on reel fore-aft position, minimum clearance can occur at guard tine, hold-down or cutterbar.

The finger to guard/cutterbar clearance with reels fully lowered is 0.78 +/- 0.12 in. (20 +/- 3 mm) measured **at both ends of each reel, and at the cutterbar flex locations** with the reel in full frown mode.

- h. If necessary, adjust outside arms as follows:

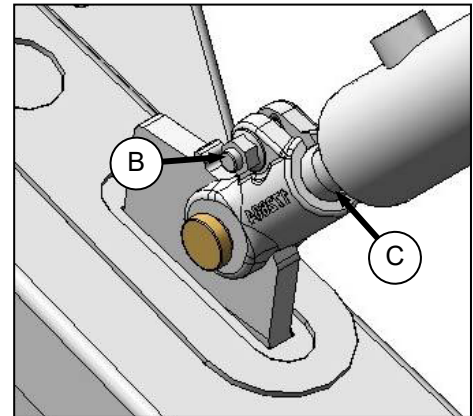

1. Loosen bolt (B).
2. Turn cylinder rod (C) counter-clockwise to raise reel and increase clearance to cutterbar, or clockwise to decrease.
3. Tighten bolt (B).
4. Repeat at opposite side.

(continued next page)

## SECTION IV. PRE-DELIVERY CHECKS

- i. If necessary, adjust center arm as follows:

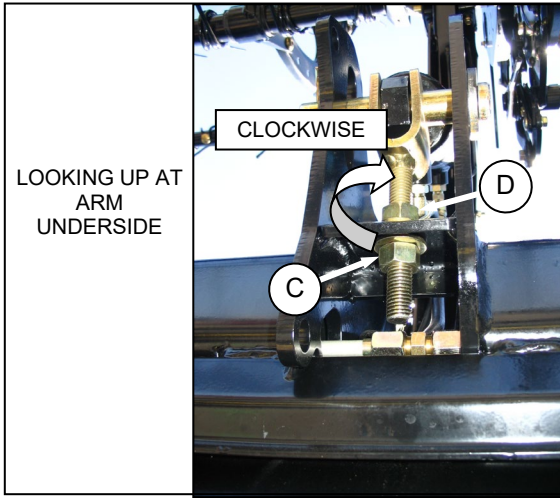

1. Loosen nut (C).
2. Turn nut (D) clockwise to raise reel and increase clearance to cutterbar, or counter-clockwise to decrease.
3. Tighten bolt (C).

### O. DRAPER SEAL

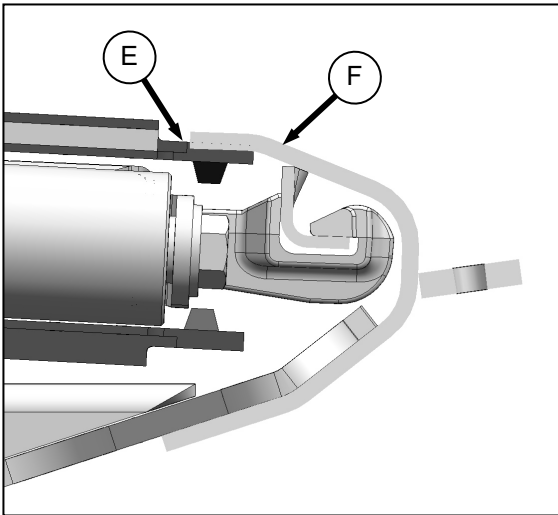

- a. Check deck height so that draper (E) runs just below cutterbar (F) with maximum 1/32 in. (1 mm) gap, or with draper deflected down slightly (up to 1/16 in. (1.5 mm)) to create a seal.

#### NOTE

*Measurement is at supports with header in working position and decks slid fully ahead.*

- b. Loosen tension on drapers. Refer to sub-step G. **DRAPER TENSION.**
- c. Lift draper up at front edge past cutterbar.

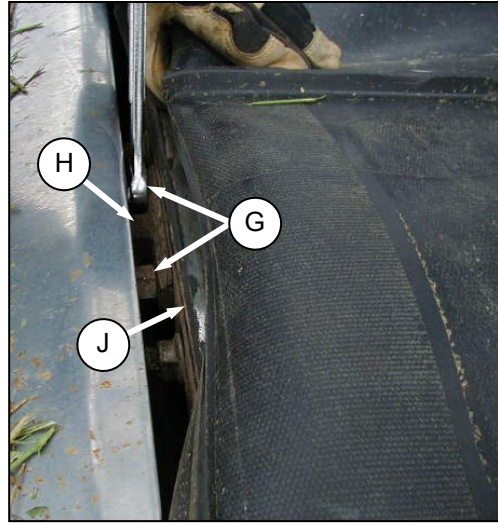

- d. Loosen two lock-nuts (G) a half-turn only on deck support (H). There are two to four supports per deck, depending on header size.
- e. Tap deck (J) to lower deck relative to supports to achieve setting recommended above. Tap support (H) using a punch to raise deck relative to support.
- f. Tighten deck support hardware (G).
  1. Tension drapers. Refer to sub-step G. **DRAPER TENSION.**

## SECTION IV. PRE-DELIVERY CHECKS

### P. LUBRICATE HEADER

Refer to the illustrations for lubrication points.

- Wipe grease fitting with a clean cloth before greasing, to avoid injecting dirt and grit.
- Inject grease through fitting with grease gun until grease overflows fitting, except where noted.
- Leave excess grease on fitting to keep out dirt.
- Replace any loose or broken fittings immediately.
- If fitting will not take grease, remove and clean thoroughly. Also clean lubricant passageway. Replace fitting if necessary.
- Use clean grease as shown.

High Temp. Extreme Pressure  
(EP2) Performance With 1%  
Max Molybdenum Disulphide  
(NLGI Grade 2).Lithium Base

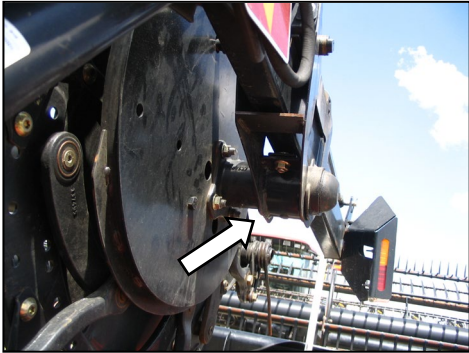

REEL SHAFT RH BEARING (1 PLC)

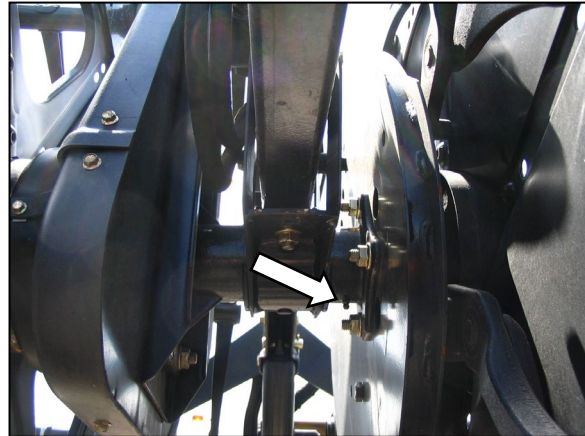

REEL CENTER BEARING (1 PLC)

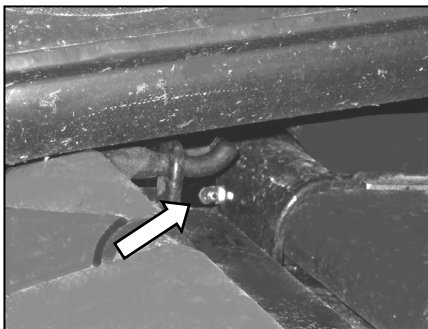
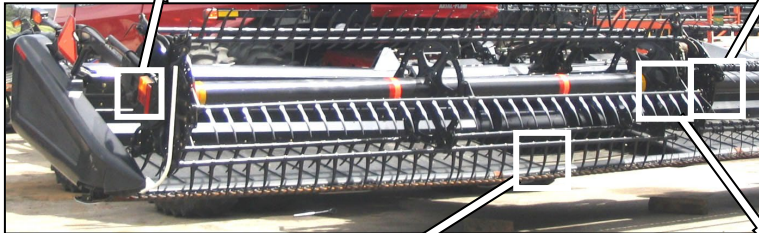

ADAPTER IDLER ROLLER (2 PLCS)

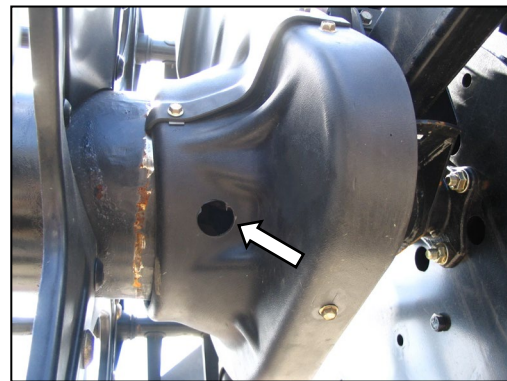

REEL UNIVERSAL (1 PLC)

*(continued next page)*

## SECTION IV. PRE-DELIVERY CHECKS

High Temp. Extreme Pressure  
(EP2) Performance With 1%  
Max Molybdenum Disulphide  
(NLGI Grade 2).Lithium Base

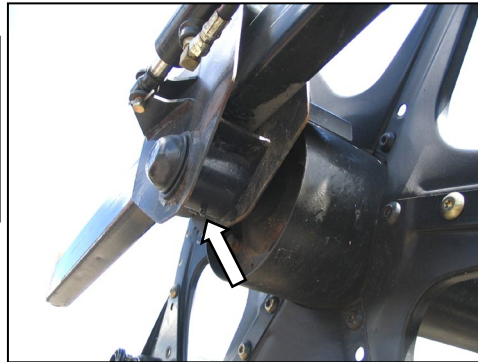

REEL SHAFT LH BEARING (1 PLC)

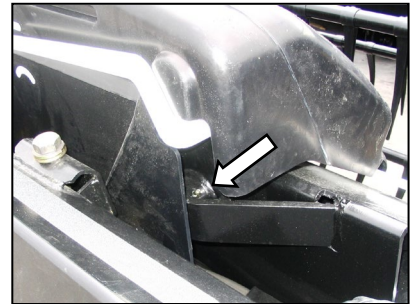

FLEX LINKAGE (BOTH SIDES)

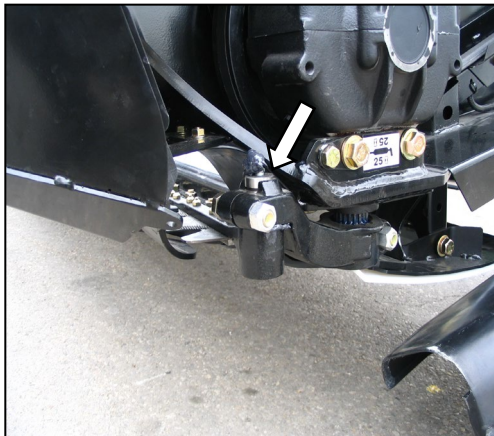

SICKLE HEAD  
(1 PLC - SINGLE KNIFE)  
(2 PLCS - DOUBLE KNIFE)

### NOTE

*To prevent binding and/or excessive wear caused by sickle pressing on guards, do not over grease. If more than 6 to 8 pumps of the grease gun are required to fill the cavity, replace the seal in the sickle head.*

*(continued next page)*

## SECTION IV. PRE-DELIVERY CHECKS

High Temp. Extreme Pressure  
(EP2) Performance With 1%  
Max Molybdenum Disulphide  
(NLGI Grade 2).Lithium Base

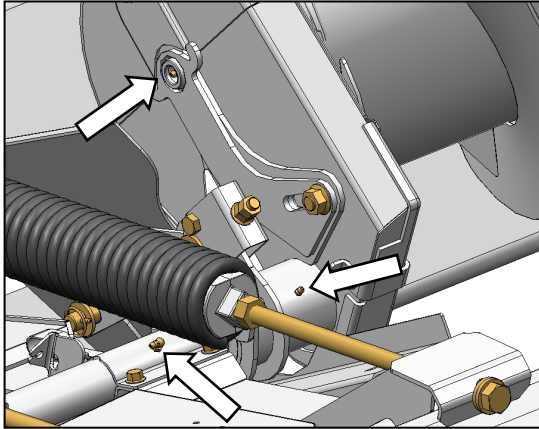
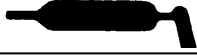

AUGER DRIVE (2 PLCS) AND PIVOT

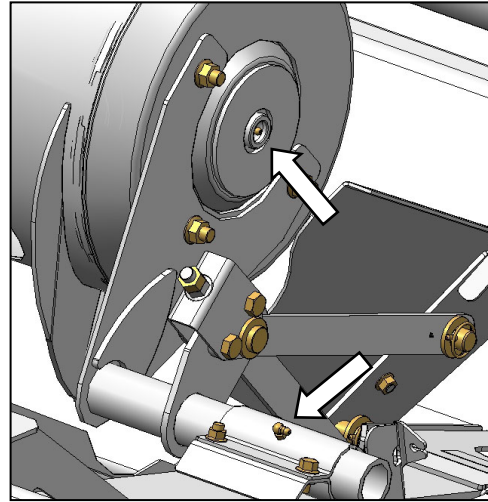

AUGER BEARING AND PIVOT

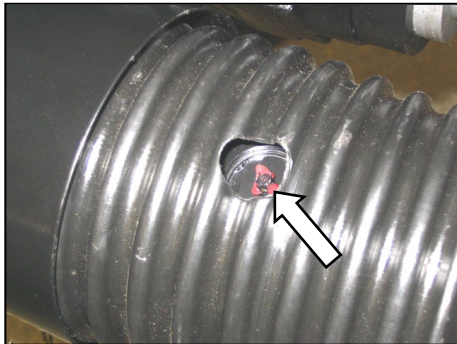

DRIVE UNIVERSAL – (2 PLCS.)

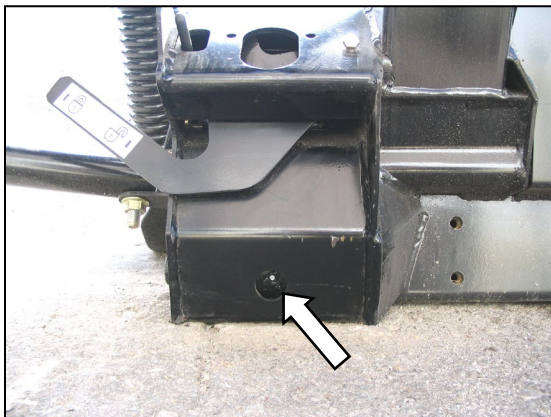
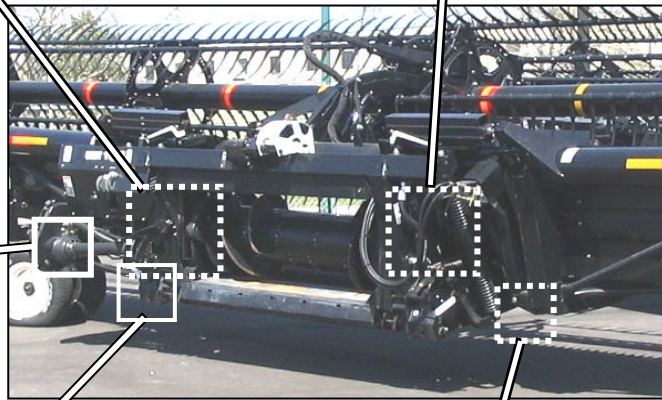

FLOAT PIVOT - BOTH SIDES

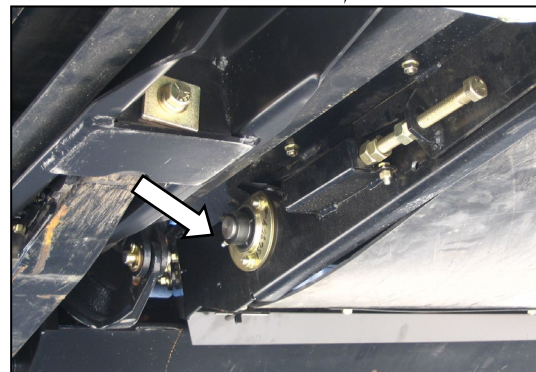

DRIVE ROLLER BEARING (1 PLC)



## SECTION IV. PRE-DELIVERY CHECKS

### Q. ENDSHIELDS

**NOTE**

*Plastic endshields are subject to expansion or contraction depending on large temperature variations. Latch pin and hinge can be adjusted to compensate for dimensional changes.*

- a. If hinged endshields are not closed, close as follows: Otherwise, go to step b.

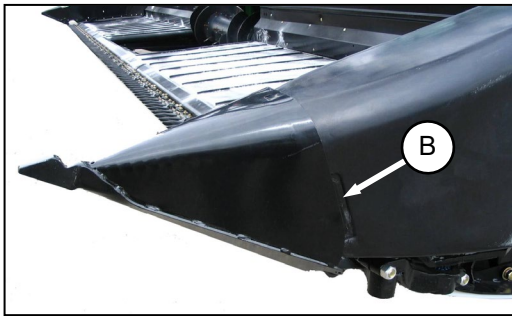
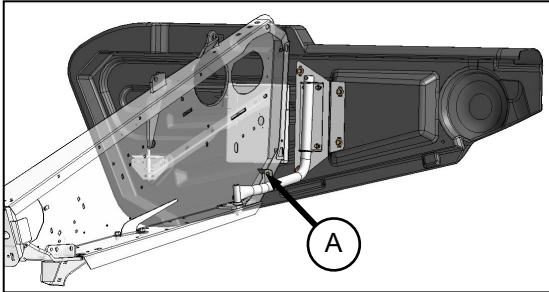

1. To close, shield, release latch (A) and swing the shield forward until the front engages the crop divider (B).



2. Push in shield opposite latch and shield will self-latch.

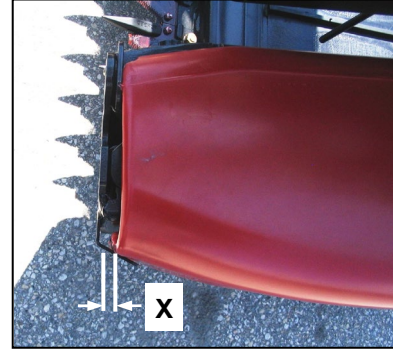

- b. Check gap "X" between the front end of the shields and the header frame and compare against values in chart.

TEMPERATURE Degrees F (C)	GAP 'X' Inches (mm)
25 (-4)	1.1 (28)
45 (7)	1.0 (24)
65 (18)	0.79 (20)
85 (29)	0.64 (16)
105 (41)	0.5 (12)
125 (52)	0.32 (8)
145 (63)	0.16 (4)
165 (89)	0

- c. If necessary, adjust the gap as follows:

#### Hinged Type

1. Open endshield(s) by pressing against latch in opening at (C) on inboard side of endsheet.

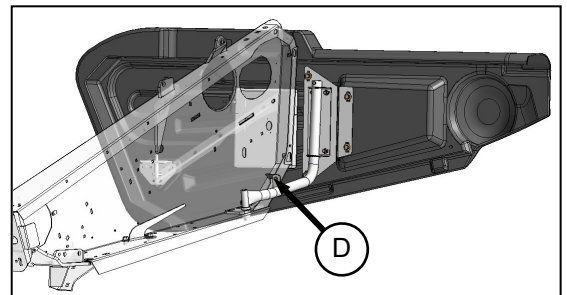
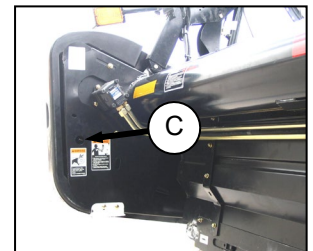

2. Pull shield away from header and swing it out and back behind the endsheet until the latch (D) engages the hook on the endsheet.

*(continued next page)*

## SECTION IV. PRE-DELIVERY CHECKS

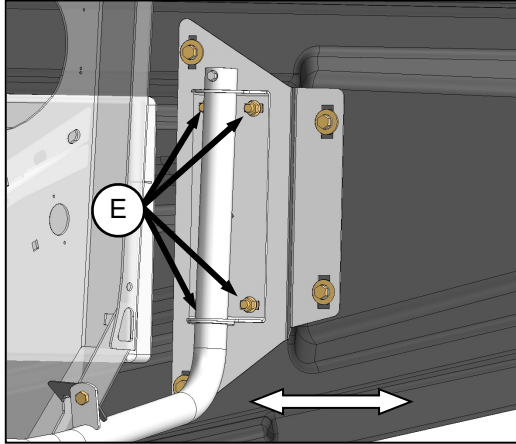

- Loosen bolts (E) on support.

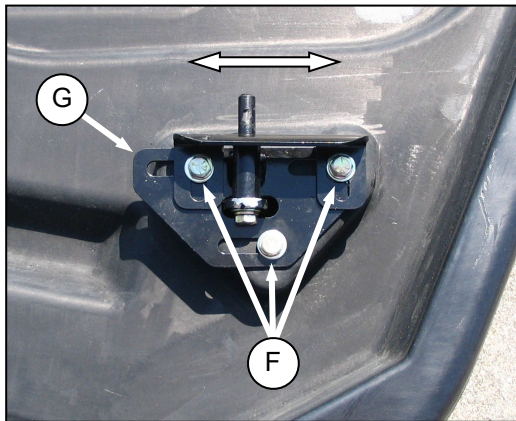

- Loosen bolts (F) on latch assembly (G).
- Adjust the endshield to achieve the gap 'X' between the front end of the shield and the header frame, in accordance with the chart.
- Tighten bolts.

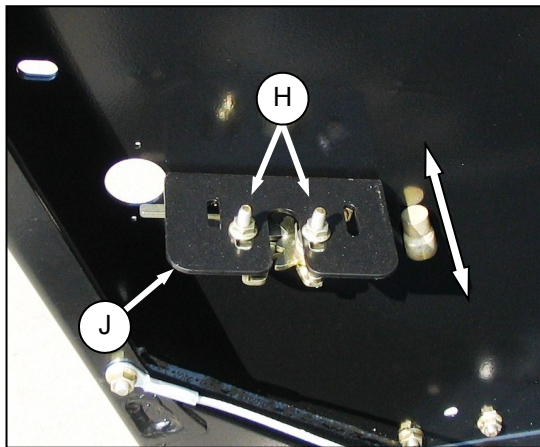

- To achieve a snug fit between the aft end of the shield and header frame, loosen bolts (H) and adjust the latch (J) to reposition the shield.

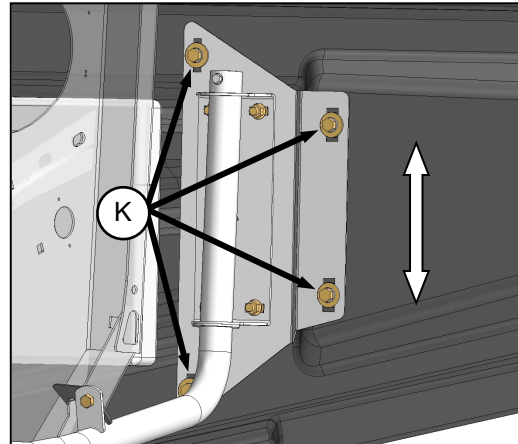
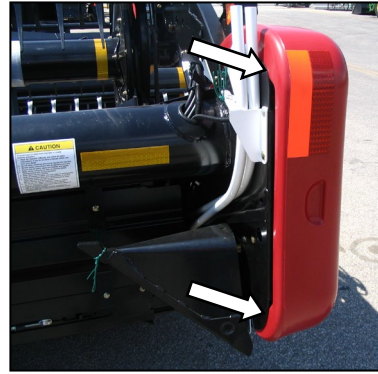

- Loosen bolts (K) on endshield support and adjust endshield to align with endsheet as shown above.
- Tighten bolts (H) and (K).
- Close shield(s) and recheck fitment.

*(continued next page)*

## SECTION IV. PRE-DELIVERY CHECKS

### Non-Hinged Type

Located on RH end of SK headers.

1. Press against latch in opening at (A) on inboard side of endsheet.

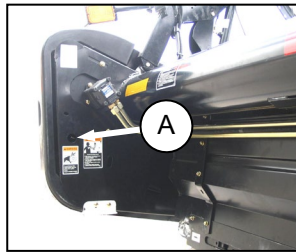

2. Lift up on shield, pull out and back to remove shield.

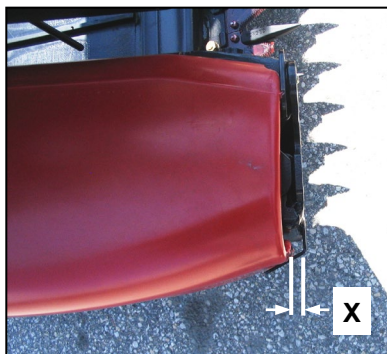
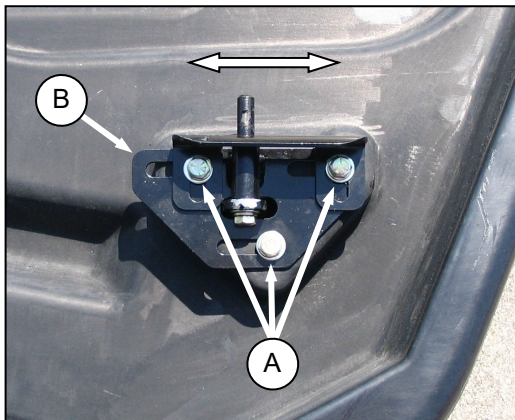

3. Loosen bolts (A) on latch assembly (B).
4. Adjust endshield to achieve the gap 'X' between front end of shield and header frame in accordance with the chart on page 78.
5. Tighten bolts (A).

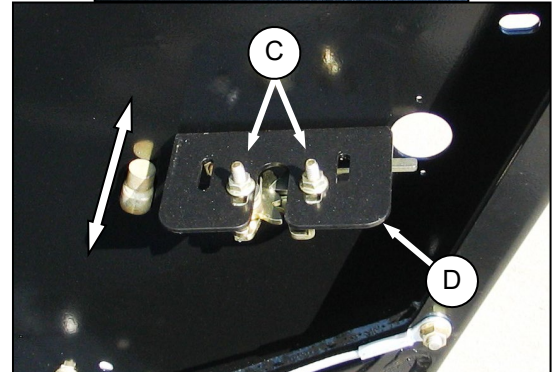
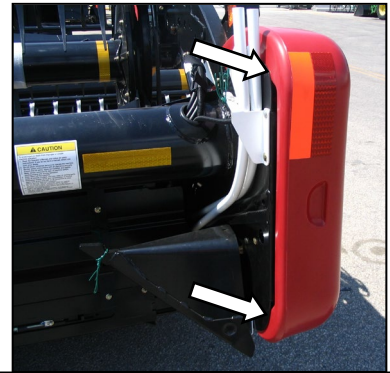

6. To achieve a snug fit between aft end of shield and header frame, loosen bolts (C) and adjust latch (D) to reposition shield.
7. Tighten bolts (C).

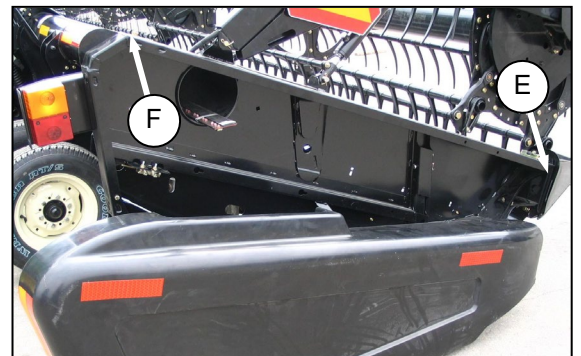

8. To install shield, locate forward end in crop divider (E) and position shield over endsheet. Pin (F) at top of endsheet must engage shield.



9. Push in shield where shown (opposite latch) and shield will self-latch.

## SECTION IV. PRE-DELIVERY CHECKS

### R. OPERATOR'S MANUAL AND PARTS CATALOGS

Check case contents. The manual case is located inside the LH endshield.

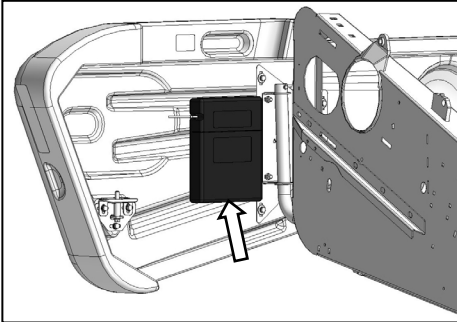

- a. Open the left endshield, and remove plastic tie on manual case.
- b. Check that case contains the following manuals:

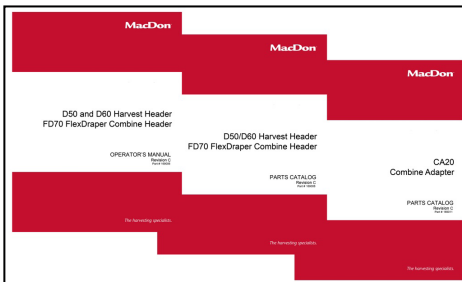

- D50 and D60 Harvest Header / FD70 FlexDraper Combine Operator's Manual #169006.
- D50 and D60 Harvest Header / FD70 FlexDraper Parts Catalog #169008.
- CA20 Combine Adapter Parts Catalog #169011.

## SECTION V. HEADER RUN-UP

### SECTION V. HEADER RUN-UP

#### STEP 1. RUN-UP THE HEADER

- a. Start combine, raise header fully, and engage header lift cylinder locks. Shutdown combine, and remove key.



#### WARNING

Stop combine engine and remove key before making adjustments to machine. A child or even a pet could engage the drive.



#### CAUTION

Engage header lift cylinder stops before working under header.

- b. Lower poly pan under adapter and check for shipping materials/debris that may have fallen

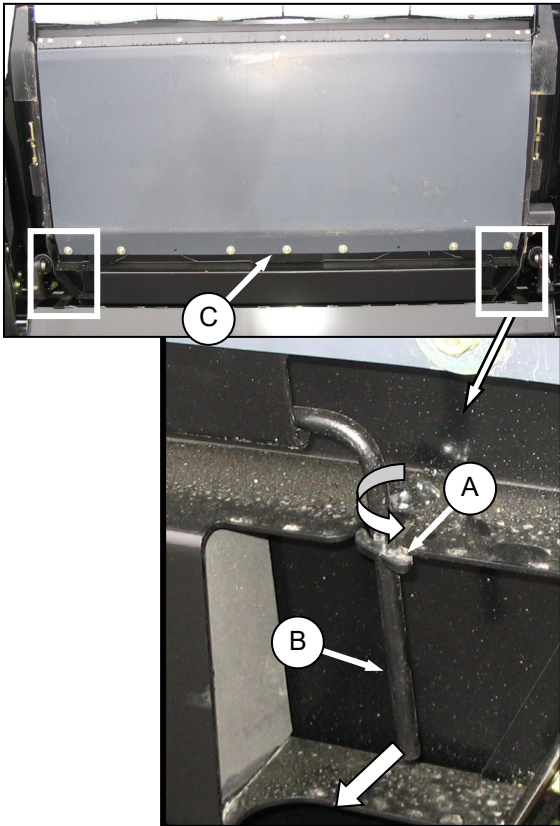

under adapter draper as follows:

1. Rotate latches (A) to unlock handle (B).
2. Hold pan (C) and rotate handle (B) to release pan. Lower pan to expose draper.

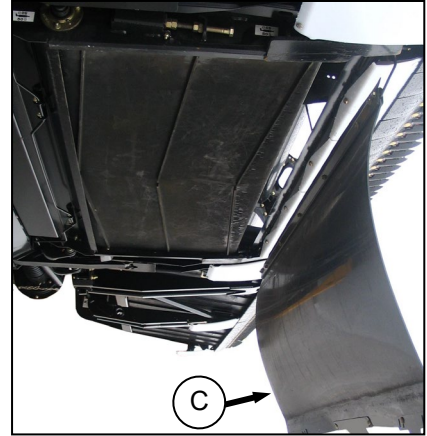

3. Check and remove debris from pan (C) and draper.

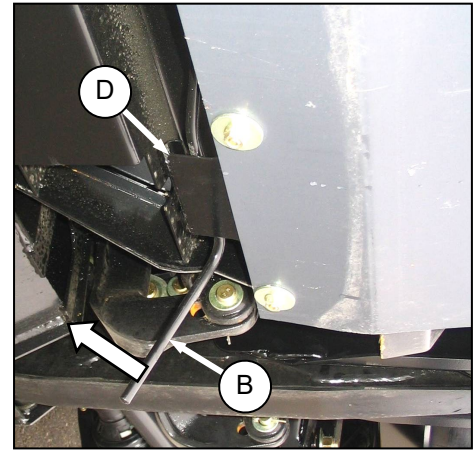

4. Raise pan and rotate handle (B) so that rod engages clips (D) on pan.

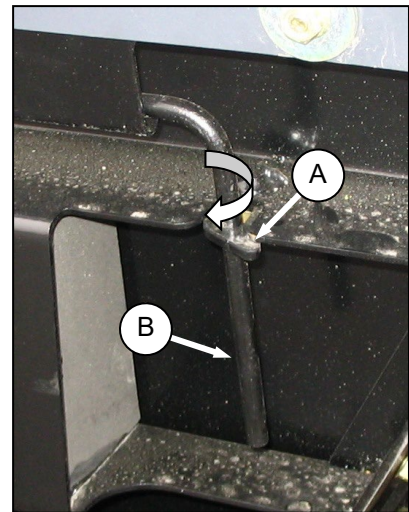

5. Push handle (B) into slot and secure with latches (A).

*(continued next page)*

## SECTION V. HEADER RUN-UP



### CAUTION

Never start or move the machine until you are sure all bystanders have cleared the area.



### CAUTION

Clear the area of other persons, pets etc. Keep children away from machinery. Walk around the machine to be sure no one is under, on or close to it.



### CAUTION

Before investigating an unusual sound or attempting to correct a problem, shut off engine, engage parking brake and remove key.

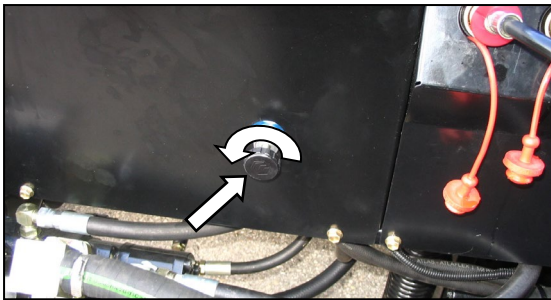

- c. Open side draper flow control 2 turns.

#### NOTE

*Reel and side drapers will not operate until oil flow fills the lines.*

- d. Ensure feeder house variable speed is set to minimum.
- e. Start combine, and run the machine slowly for 5 minutes, watching and listening FROM THE OPERATOR'S SEAT for binding or interfering parts.
- f. Run the machine at operating speed for 15 minutes. Listen for any unusual sounds or abnormal vibration.
- g. Perform the run-up check as listed on the "**Pre-Delivery Checklist**" (yellow sheet attached to this instruction) to ensure the machine is field-ready.

## SECTION V. HEADER RUN-UP

### STEP 2. POST RUN-UP ADJUSTMENTS

The following adjustments may be necessary after the run-up:



#### WARNING

Stop combine engine and remove key before making adjustments to machine. A child or even a pet could engage the drive.

#### A. KNIFE

- a. Check guards for signs of heating during run-up due to insufficient clearance between guard and sickle. If heating is evident, proceed as follows:

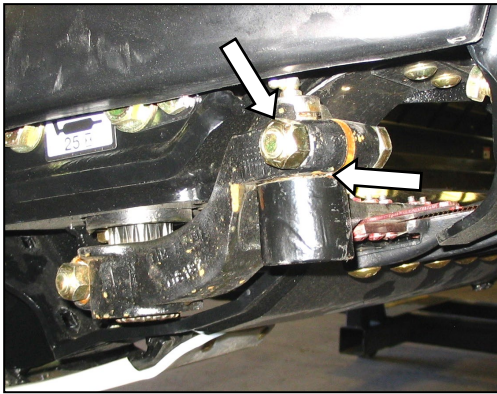

1. Check gap between knife head and pitman arm. A business card should slide easily through the gap. If not, then adjust gap by loosening bolt and tapping knife head with a hammer. Re-tighten bolt.

- b. Adjust guard alignment as follows: The guard straightening tool (MacDon #140135) is available from your MacDon Dealer.



UPWARD ADJUSTMENT

1. To adjust guard tips upwards, position tool as shown at and pull up.



DOWNWARD ADJUSTMENT

2. To adjust tips downward, position tool as shown and push down.

## SECTION V. HEADER RUN-UP

### B. KNIFE SPEED

The header knife drive is driven by the adapter mounted hydraulic pump. The knife drive speed is factory set for a feeder house speed of 575 rpm for CNH and John Deere adapters, and 780 rpm for AGCO and Lexion adapters.

#### IMPORTANT

For variable speed feeder houses, this will be the **minimum** speed setting. To operate variable speed feeder house at greater than minimum speed, flow to the knife drive motor must be reduced to prevent excessive speeds which could result in premature knife failure.

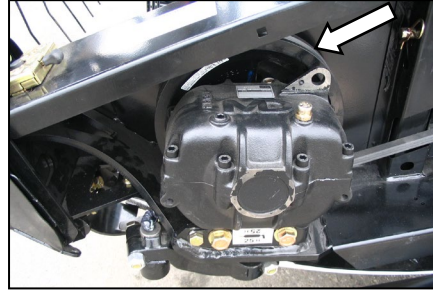

- d. Have someone check the rpm of the wobble box pulley using a hand held tachometer.
- e. Shutdown the combine, and close endshield.
- f. Compare actual pulley rpm with the values in the following chart:

Header Size	Recommended Knife Drive Speed Range (RPM)	
	Single Knife	Double Knife
25 FOOT	550 - 675	600 - 800
30 FOOT	550 - 650	600 - 725
35 FOOT	550 - 600	550 - 700
40 FOOT	525 - 600	550 - 650
45 FOOT	N/A	550 - 650



### WARNING

Stop combine engine and remove key before making adjustments to machine. A child or even a pet could engage the drive.

- a. Stop combine engine and remove key from ignition.



- b. Open the LH endshield.



### WARNING

Ensure bystanders are clear before starting.

- c. Start combine engine, engage the header drive, and run the combine at operating rpm.

- g. If adjustment to the wobble box pulley rpm is necessary, contact your MacDon Dealer or refer to the D60/FD70/CA20 Technical Manual.

- h.



## NOTES

## Model FD70 FlexDraper / CA20 Combine Adapter Pre-Delivery Checklist - N.A.

Perform these checks prior to delivery to your customer. **Adjustments are normally not required as the machine is factory assembled and adjusted.** If adjustments are required, refer to the appropriate page number in this manual. The completed checklist should be retained either by the operator or the dealer.



**CAUTION: Carefully follow the instructions given. Be alert for safety related messages which bring your attention to hazards and unsafe practices.**

Header Serial Number: \_\_\_\_\_ Adapter Serial Number: \_\_\_\_\_

✓	<u>ITEM</u>	<u>PAGE</u>
	Check for shipping damage or missing parts. Be sure all shipping dunnage is removed.	---
	Check for loose hardware. Tighten to required torque.	5
	Check tire pressure (Transport/Stabilizer Option).	62
	Check wheel bolt torque (Transport/Stabilizer Option).	62
	Check wobble box breather position.	62
	Check wobble box lube level.	62
	Check adapter gearbox lube level.	63
	Check hydraulic reservoir lube level before and after run-up.	63
	Check sickle drive belt(s) tension.	64
	Check reel centered between header endsheets (header in full smile).	64
	Grease all bearings and drivelines.	75 - 77
	Check side draper tension.	65
	Check draper seal.	74
	Check wing balance.	70
	Check wing float lock adjustment (cutterbar alignment).	69
	Check header main float.	66
	Check reel tine to cutterbar clearance.	73
	Check skid shoes are evenly adjusted at a setting appropriate for first crop.	72
	Check fitment of endshields.	78
	Ensure feeder house variable speed is set to minimum.	---
	<b>RUN-UP PROCEDURE</b>	82
	Check hydraulic hose and wiring harness routing for clearance when raising or lowering header and reel.	---
	Check lights are functional.	61
	Check knife speed.	85
	<b>POST RUN-UP CHECK. STOP ENGINE.</b>	84
	Check belt and chain drives for heated bearings.	12 & 63
	Check knife sections for discolouration caused by misalignment of components.	84
	Check for hydraulic leaks.	---
	Check manual storage case contains Operator's Manual and Parts Catalogs.	81

Date Checked: \_\_\_\_\_

Checked by: \_\_\_\_\_



# MacDon™

**MacDon Industries Ltd.**

680 Moray Street  
Winnipeg, Manitoba  
Canada R3J 3S3  
t. (204) 885-5590  
f. (204) 832-7749

**MacDon Inc.**

10708 N. Pomona Avenue  
Kansas City, Missouri  
United States, 64153-1924  
t. (816) 891-7313  
f. (816) 891-7323

**MacDon Australia Pty. Ltd.**

A.C.N. 079 393 721  
P.O. Box 243  
Suite 3, 143 Main Street  
Greensborough, Victoria  
Australia 3088  
t. 03 9432 9982  
f. 03 9432 9972

## CUSTOMERS

[www.macdon.com](http://www.macdon.com)

## DEALERS

[www.macdondealers.com](http://www.macdondealers.com)

Trademarks of products are the marks of their  
respective manufacturers and/or distributors.

Printed in Canada