

MacDon™

**Model FD70 FlexDraper®
with
CA20 Combine Adapter**

**UNLOADING &
ASSEMBLY INSTRUCTIONS
for
NORTH AMERICAN SHIPMENTS**



MacDon FD70 FlexDraper with CA20 Combine Adapter

INTRODUCTION

This instruction describes the unloading, set-up and pre-delivery requirements for the MacDon FD70 FlexDraper with a CA20 Combine Adapter for North America. The header may be delivered in either North American configuration or Export configuration. Use the table of contents to guide you to specific areas. Retain this instruction for future reference.

CAREFULLY READ ALL THE MATERIAL PROVIDED BEFORE ATTEMPTING TO UNLOAD, ASSEMBLE, OR USE THE MACHINE.

TABLE OF CONTENTS

INTRODUCTION	1
GENERAL SAFETY	3
RECOMMENDED TORQUES	5
A. GENERAL	5
B. SAE BOLTS	5
C. METRIC BOLTS.....	5
D. HYDRAULIC FITTINGS.....	6
ENGLISH/METRIC EQUIVALENTS	7
SECTION I. UNLOADING	8
A. SINGLE FORKLIFT METHOD.....	8
B. COMBINE METHOD.....	9
C. TWO FORKLIFT METHOD.....	10
SECTION II. ASSEMBLY – NORTH AMERICA	11
STEP 1. REPOSITION GEARBOX.....	11
STEP 2. INSTALL REEL SPEED SENSOR	12
A. REMOVE COVER	12
B. JOHN DEERE SENSOR INSTALLATION.....	14
C. LEXION 500 SERIES SENSOR INSTALLATION.....	16
D. LEXION 400 SERIES SENSOR INSTALLATION.....	18
E. AGCO SENSOR INSTALLATION.....	20
F. INSTALL COVER.....	21
STEP 3. INSTALL OPTIONS.....	21
STEP 4. SET-UP ADAPTER	22
A. TOP LINK KIT	22
B. FLIGHTING EXTENSIONS.....	22
C. STRIPPER BARS.....	22
D. CR FEEDER DEFLECTORS	23
STEP 5. ATTACH TO COMBINE	24
A. CASE IH.....	24
B. CASE IH 23, 25 SERIES	27
C. JOHN DEERE 60, 70 SERIES.....	30
D. JOHN DEERE 50 SERIES.....	32
E. LEXION.....	34
F. NEW HOLLAND	38
G. AGCO.....	40
STEP 6. REMOVE SHIPPING SUPPORTS	43
STEP 7. POSITION TRANSPORT LIGHTS	43
STEP 8. INSTALL CROP DIVIDERS.....	44
STEP 9. PRE-DELIVERY CHECKS	44
SECTION III. ASSEMBLY – EXPORT	45
STEP 1. INSTALL CENTER LINK	45
STEP 2. INSTALL FLOAT LINKS.....	49
STEP 3. INSTALL REEL SPEED SENSOR	50
STEP 4. INSTALL OPTIONS.....	50
STEP 5. ATTACH REEL LIFT CYLINDERS	51
STEP 6. ATTACH CAM ARMS.....	54
STEP 7. INSTALL REEL END SHIELDS.....	55
STEP 8. INSTALL CENTER FORE/AFT CYLINDER	57
STEP 9. SET-UP ADAPTER	57
STEP 10. ATTACH TO COMBINE	57
STEP 11. CONNECT FORE-AFT CYLINDERS	58
STEP 12. INSTALL CROP DIVIDERS.....	59
STEP 13. POSITION TRANSPORT LIGHTS	60
STEP 14. PRE-DELIVERY CHECKS	60
SECTION IV. PRE-DELIVERY CHECKS	61

A.	TIRE PRESSURE - SLOW SPEED TRANSPORT & STABILIZER WHEEL OPTIONS.....	61
B.	WHEEL BOLT TORQUE - SLOW SPEED TRANSPORT & STABILIZER WHEEL OPTIONS	61
C.	WOBBLE BOX.....	61
D.	GEARBOX OIL	62
E.	HYDRAULIC RESERVOIR.....	62
F.	SICKLE DRIVE BELT TENSION.....	63
G.	REEL CENTERING.....	63
H.	DRAPER TENSION	64
I.	HEADER MAIN FLOAT	65
J.	TRIM SPRINGS	67
K.	CUTTERBAR ALIGNMENT.....	68
L.	WING BALANCE.....	68
M.	SKID SHOE SETTINGS.....	69
N.	REEL TINE TO CUTTERBAR CLEARANCE.....	70
O.	LUBRICATE HEADER	72
P.	ENDSHIELDS	75
Q.	OPERATOR'S MANUAL AND PARTS CATALOGS.....	78
SECTION V. HEADER RUN-UP		79
STEP 1.	RUN-UP THE HEADER.....	79
STEP 2.	POST RUN-UP ADJUSTMENTS.....	80

GENERAL SAFETY



CAUTION

- The following are general farm safety precautions that should be part of your operating procedure for all types of machinery.
- Protect yourself.

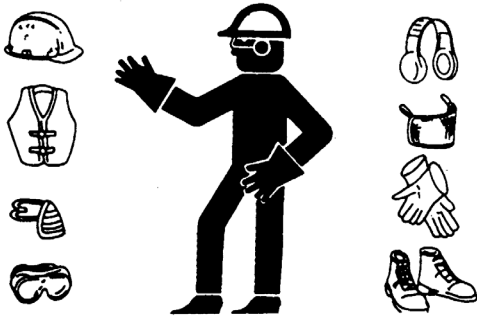

- When assembling, operating and servicing machinery, wear all the protective clothing and personal safety devices that **COULD** be necessary for the job at hand. Don't take chances.
- You may need:
 - a hard hat.
 - protective shoes with slip resistant soles.
 - protective glasses or goggles.
 - heavy gloves.
 - wet weather gear.
 - respirator or filter mask.
 - hearing protection. Be aware that prolonged exposure to loud noise can cause impairment or loss of hearing. Wearing a suitable hearing protective device such as ear muffs (A) or ear plugs (B) protects against objectionable or loud noises.

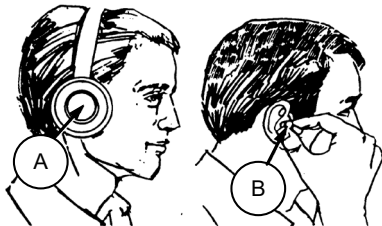

- Provide a first-aid kit for use in case of emergencies.
- Keep a fire extinguisher on the machine. Be sure the extinguisher is properly maintained and be familiar with its proper use.
- Keep young children away from machinery at all times.
- Be aware that accidents often happen when the operator is tired or in a hurry to get finished. Take the time to consider the safest way. Never ignore warning signs of fatigue.
- Wear close-fitting clothing and cover long hair. Never wear dangling items such as scarves or bracelets.
- Keep hands, feet, clothing and hair away from moving parts. Never attempt to clear obstructions or objects from a machine while the engine is running.

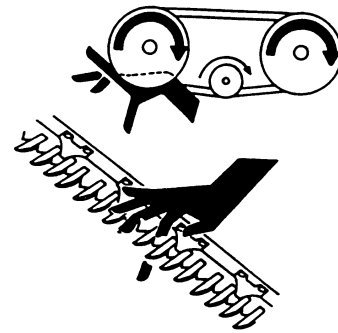

- Keep all shields in place. Never alter or remove safety equipment. Make sure driveline guards can rotate independently of the shaft and can telescope freely.

- Use only service and repair parts made or approved by the equipment manufacturer. Substituted parts may not meet strength, design, or safety requirements.
- Do not modify the machine. Unauthorized modifications may impair the function and/or safety and affect machine life.
- Stop engine and remove key from ignition before leaving operator's seat for any reason. A child or even a pet could engage an idling machine.



- Keep the area used for servicing machinery clean and dry. Wet or oily floors are slippery. Wet spots can be dangerous when working with electrical equipment. Be sure all electrical outlets and tools are properly grounded.
- Use adequate light for the job at hand.
- Keep machinery clean. Do not allow oil or grease to accumulate on service platforms, ladders or controls. Clean machines before storage.
- Never use gasoline, naphtha or any volatile material for cleaning purposes. These materials may be toxic and/or flammable.
- When storing machinery, cover sharp or extending components to prevent injury from accidental contact.

RECOMMENDED TORQUES

A. GENERAL

The tables shown below give correct torque values for various bolts and capscrews.

- Tighten all bolts to the torques specified in chart unless otherwise noted throughout this manual.
- Check tightness of bolts periodically, using bolt torque chart as a guide.
- Replace hardware with the same strength bolt.
- Torque figures are valid for non-greased or non-oiled threads and heads unless otherwise specified. Do not grease or oil bolts or capscrews unless specified in this manual. When using locking elements, increase torque values by 5%.

B. SAE BOLTS

BOLT DIA. "A" (in.)	NC BOLT TORQUE			
	SAE 5		SAE 8	
	ft·lbf	N·m	ft·lbf	N·m
1/4	9	12	11	15
5/16	18	24	25	34
3/8	32	43	41	56
7/16	50	68	70	95
1/2	75	102	105	142
9/16	110	149	149	202
5/8	150	203	200	271
3/4	265	359	365	495
7/8	420	569	600	813
1	640	867	890	1205

* Torque categories for bolts and capscrews are identified by their head markings.

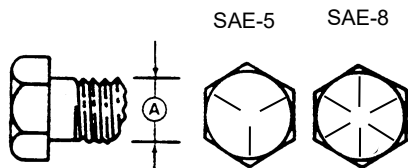

C. METRIC BOLTS

BOLT DIA. "A"	NC BOLT TORQUE*			
	8.8		10.9	
	ft·lbf	N·m	ft·lbf	N·m
M3	0.4	0.5	1.3	1.8
M4	2.2	3	3.3	4.5
M5	4	6	7	9
M6	7	10	11	15
M8	18	25	26	35
M10	37	50	52	70
M12	66	90	92	125
M14	103	140	148	200
M16	166	225	229	310
M20	321	435	450	610
M24	553	750	774	1050
M30	1103	1495	1550	2100
M36	1917	2600	2710	3675

* Torque categories for bolts and capscrews are identified by their head markings.

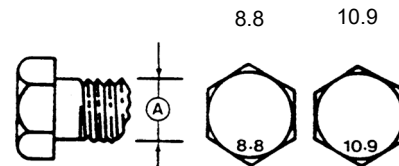

D. HYDRAULIC FITTINGS

FLARE TYPE

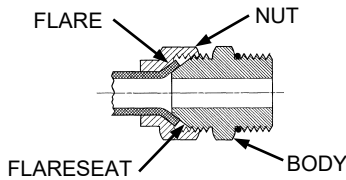

- Check flare and flare seat for defects that might cause leakage.
- Align tube with fitting before tightening.
- Lubricate connection and hand tighten swivel nut until snug.
- To prevent twisting the tube(s), use two wrenches. Place one wrench on the connector body and with the second, tighten the swivel nut to the torque shown.

TUBE SIZE O.D. (in.)	NUT SIZE ACROSS FLATS (in.)	TORQUE VALUE*		RECOMMENDED TURNS TO TIGHTEN (AFTER FINGER TIGHTENING)	
		ft·lbf	N·m	Flats	Turns
3/16	7/16	6	8	1	1/6
1/4	9/16	9	12	1	1/6
5/16	5/8	12	16	1	1/6
3/8	11/16	18	24	1	1/6
1/2	7/8	34	46	1	1/6
5/8	1	46	62	1	1/6
3/4	1-1/4	75	102	3/4	1/8
7/8	1-3/8	90	122	3/4	1/8

* The torque values shown are based on lubricated connections as in reassembly.

O-RING TYPE

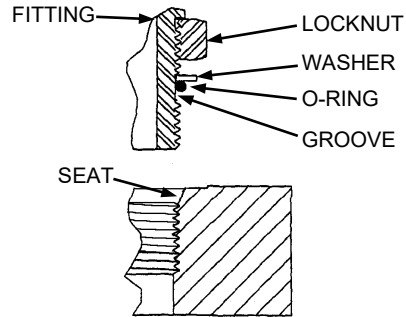

- Inspect O-ring and seat for dirt or obvious defects.

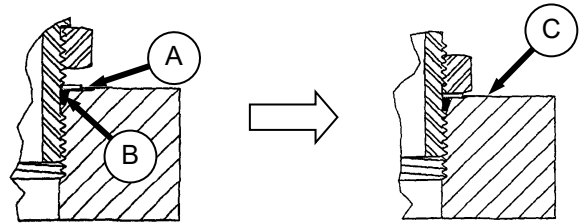

- On angle fittings, back off the lock nut until washer (A) bottoms out at top of groove (B) in fitting.
- Hand tighten fitting until back up washer (A) or washer face (if straight fitting) bottoms on part face (C) and O-ring is seated.
- Position angle fittings by unscrewing no more than one turn.
- Tighten straight fittings to torque shown.
- Tighten angle fittings to torque shown in the following table while holding body of fitting with a wrench.

THD SIZE (in.)	NUT SIZE ACROSS FLATS (in.)	TORQUE VALUE*		RECOMMENDED TURNS TO TIGHTEN (AFTER FINGER TIGHTENING)	
		ft·lbf	N·m	Flats	Turns
3/8	1/2	6	8	2	1/3
7/16	9/16	9	12	2	1/3
1/2	5/8	12	16	2	1/3
9/16	11/16	18	24	2	1/3
3/4	7/8	34	46	2	1/3
7/8	1	46	62	1-1/2	1/4
1-1/16	1-1/4	75	102	1	1/6
1-3/16	1-3/8	90	122	1	1/6
1-5/16	1-1/2	105	142	3/4	1/8
1-5/8	1-7/8	140	190	3/4	1/8
1-7/8	2-1/8	160	217	1/2	1/12

* The torque values shown are based on lubricated connections as in reassembly.

ENGLISH/METRIC EQUIVALENTS

QUANTITY	INCH-POUND UNITS		FACTOR	SI UNITS (METRIC)	
	UNIT NAME	ABBR.		UNIT NAME	ABBR.
Area	acres	acres	$\times 0.4047 =$	hectares	ha
Flow	US gallons per minute	(gpm)	$\times 3.7854 =$	liters per min	L/min
Force	pounds force	lbf	$\times 4.4482 =$	Newtons	N
Length	inch	in.	$\times 25.4 =$	millimeters	mm
	foot	ft	$\times 0.305 =$	meters	m
Power	horsepower	hp	$\times 0.7457 =$	kilowatts	kW
Pressure	pounds per square inch	psi	$\times 6.8948 =$	kilopascals	kPa
			$\times .00689 =$	megapascals	MPa
Torque	pound feet or foot pounds	lbf·ft or ft·lbf	$\times 1.3558 =$	newton meters	N·m
	pound inches or inch pounds	lbf·in. or in·lbf	$\times 0.1129 =$	newton meters	N·m
Temperature	degrees Fahrenheit	°F	$(F - 32) \times 0.56 =$	Celsius	°C
Velocity	feet per minute	ft/min	$\times 0.3048 =$	meters per min	m/min
	feet per second	ft/s	$\times 0.3048 =$	meters per sec	m/s
	miles per hour	mph	$\times 1.6063 =$	kilometers per hour	km/h
Volume	US gallons	US gal.	$\times 3.7854 =$	liters	L
	ounces	oz.	$\times 29.5735 =$	milliliters	ml
	cubic inches	in. ³	$\times 16.3871 =$	cubic centimeters	cm ³ or cc
Weight	pounds	lb	$\times 0.4536 =$	kilograms	kg

SECTION I. UNLOADING

SECTION I. UNLOADING

A. SINGLE FORKLIFT METHOD



CAUTION

Equipment used for unloading must meet or exceed the requirements specified below. Using inadequate equipment may result in chain breakage, vehicle tipping or machine damage.

LIFTING VEHICLE	
Min. Lifting Capacity	9000 lb (4082 kg) *
Min. Fork Length	78 in. (1981 mm)

* At 48 inches (1220 mm) from back end of forks.

IMPORTANT

Forklifts are normally rated for a load located 24 inches (610 mm) ahead of back end of the forks. To obtain the forklift capacity at 48 inches (1220 mm), check with your forklift distributor.



- a. Move trailer into position and block trailer wheels.
- b. Lower trailer storage stands.



CAUTION

To avoid injury to bystanders from being struck by machinery, do not allow persons to stand in unloading area.

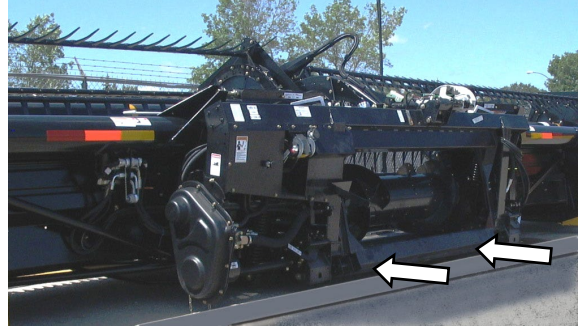

- c. Approach header from its backside and slide forks in underneath adapter lower beam structure as far as possible.
- d. Remove hauler's tie down straps and chains.



WARNING

Be sure forks are secure before moving away from load. Stand clear when lifting.

- e. Raise windrower off deck.
- f. Back up until unit clears trailer and slowly lower to 6 inches (150 mm) from ground.
- g. Take machine to storage or set-up area.
- h. Place 6 inch (150 mm) blocks under each end of cutterbar.
- i. Lower header onto blocks.
- j. Check for shipping damage and missing parts.

SECTION I. UNLOADING

B. COMBINE METHOD

The header is shipped with a fully assembled adapter and will have the necessary frame for attachment to the combine. Ensure the adapter configuration is identified and the appropriate combine is used to pick up the header.

NOTE

A maximum difference of 36 inches (914 mm) (dimension 'X' in illustration) in elevation between a standard or drop-deck truck flatbed and the combine is required for the combine to lift the header off the truck (i.e. using a loading ramp). This may vary with combine make and model.

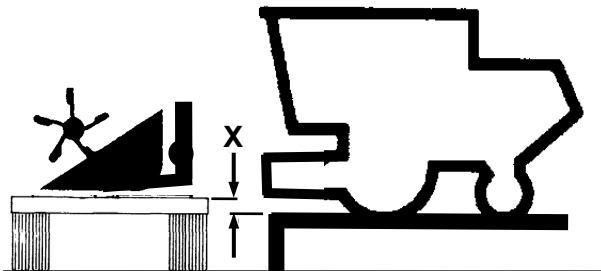

- a. Park the truck next to and at 90 degrees to the ramp, and with the rear of the header on the ramp side. Align the header pick up points approximately with the center of the ramp.
- b. Lower trailer storage stands.
- c. Remove hauler's tie-down straps and chains.
- d. Drive combine onto the ramp and approach header.

NOTE

If a suitable ramp is not available, a ditch or other ground contour can provide the required difference in elevation.

- e. Pick up header as would normally be done. Refer to STEP 5. ATTACH TO COMBINE in this instruction.

NOTE

The hydraulics and electrical connections are not required to unload the header.

- f. Raise header off the flatbed and back combine away.
- g. Take machine to storage or set-up area.
- h. Place 6 inch (150 mm) blocks under each end of cutterbar.
- i. Lower header onto blocks.
- j. Detach header from combine.
- k. Check for shipping damage and missing parts.

SECTION I. UNLOADING

C. TWO FORKLIFT METHOD



CAUTION

Equipment used for unloading must meet or exceed the requirements specified below. Using inadequate equipment may result in chain breakage, vehicle tipping or machine damage.

LIFTING VEHICLE	
Min. Lifting Capacity *	5000 lb (2268 kg)
Min. Fork Length	78 in. (1981 mm)

* At 48 inches (1220 mm) from back end of forks.

IMPORTANT

Forklifts are normally rated for a load located 24 inches (610 mm) ahead of back end of the forks. To obtain the forklift capacity at 48 inches (1220 mm), check with your forklift distributor.

- a. Position trailer to provide access by forklifts on both sides.

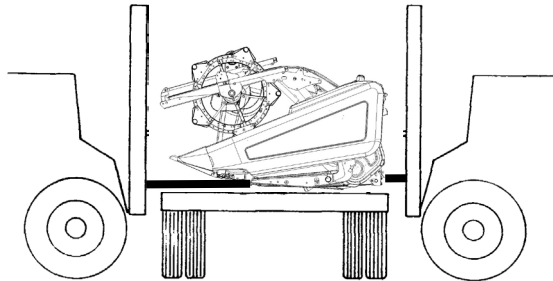

- b. Approach header from both sides.

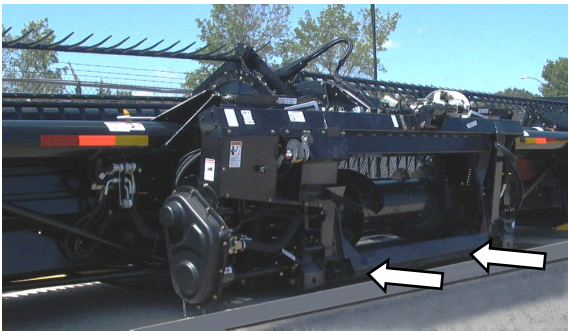

- c. Position forks underneath adapter lower beam structure with one forklift.

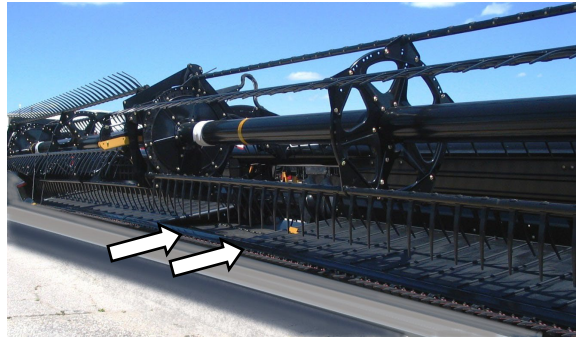

- d. Position forks underneath under cutterbar with other forklift.
- e. Remove hauler's tie down straps and chains.
- f. Slowly raise both forklifts until header clears trailer bed by 4-8 inches (102-204 mm).
- g. Slowly drive truck forward until trailer is clear of header.
- h. Place 6 inch (150 mm) blocks under each end of cutterbar.
- i. Lower header onto blocks.
- j. Back forklifts away from header.
- k. Check for shipping damage and missing parts.

SECTION II. ASSEMBLY – NORTH AMERICA

SECTION II. ASSEMBLY – NORTH AMERICA

IMPORTANT

If assembling a header shipped in EXPORT configuration, go to SECTION III. ASSEMBLY-EXPORT.

STEP 1. REPOSITION GEARBOX

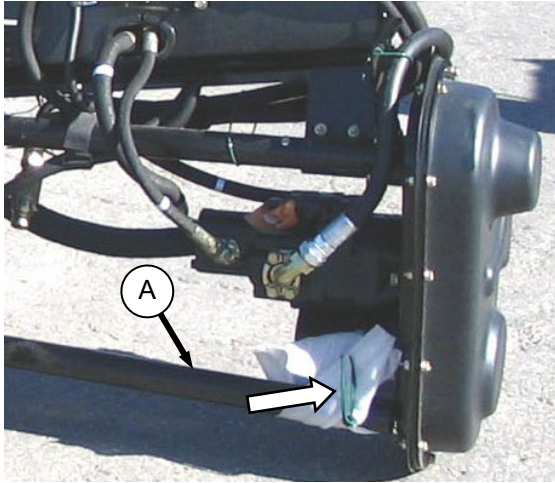

- a. Remove shipping wire and wrapping on brace and swing brace (A) clear of gearbox.



- b. Loosen nut (B) and move bolt out of shipping position slot.

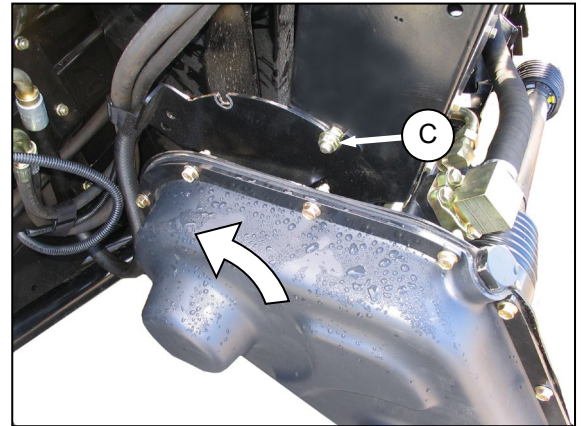

- c. Rotate gearbox and move bolt into working position slot (C). Tighten nut.
- d. Remove bolt and nut from bracket on gearbox.

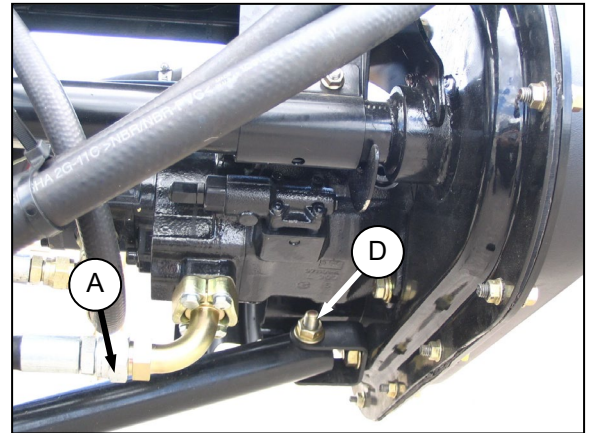

- e. Position brace (A) inside bracket and re-install bolt (D) and nut.

SECTION II. ASSEMBLY – NORTH AMERICA

STEP 2. INSTALL REEL SPEED SENSOR

NOTE

This step is not applicable to CASE/CNH combines. Proceed to STEP 4 INSTALL OPTIONS.

IMPORTANT

Except for Lexion combines, sensors are not supplied with MacDon Combine Adapters having Serial Numbers earlier than 177626_07. Sensors need to be purchased as per the following:

COMBINE	SENSOR PART NO,
JOHN DEERE-ALL	John Deere #AH116104 & Two Nuts #H104418.
AGCO-ALL	AGCO #71 391 021



CAUTION

To avoid personal injury, before servicing header or opening drive covers:

- Fully lower the header. If necessary to service in the raised position, always engage lift cylinder stops.
- Stop engine and remove key.
- Engage park brake.

A. REMOVE COVER

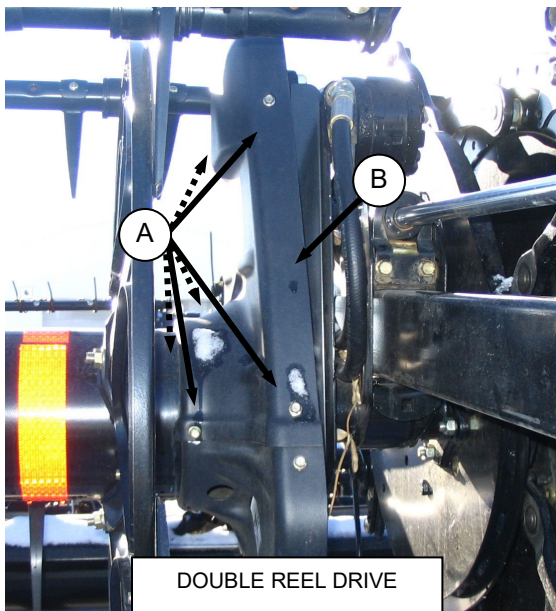

- a. Remove six screws (A) and remove drive upper cover (B).

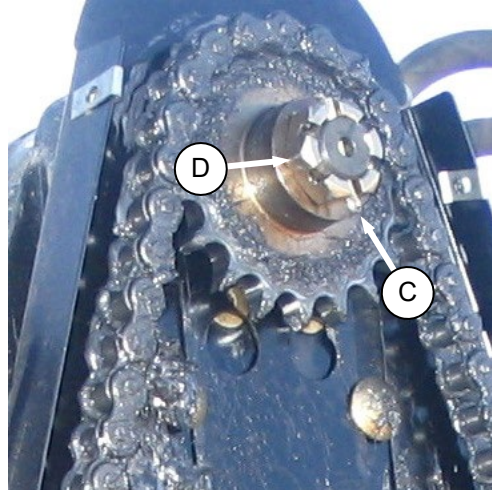

- b. Remove cotter pin (C) and remove slotted nut (D) from drive motor shaft.

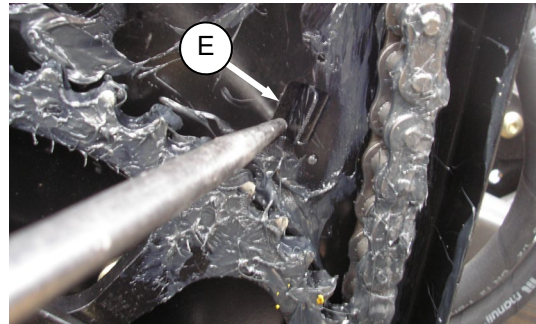

- c. Remove knock-out (E) in chain case for wire harness routing.

NOTE

Clean off grease to expose knock-out.

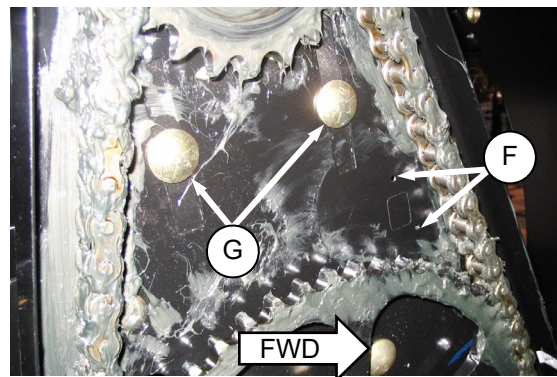

- d. If necessary, clean up holes (FF) with a 0.125 in. (3.2 mm) drill.
 e. Remove bolts (G) in chain case.

(continued next page)

SECTION II. ASSEMBLY – NORTH AMERICA

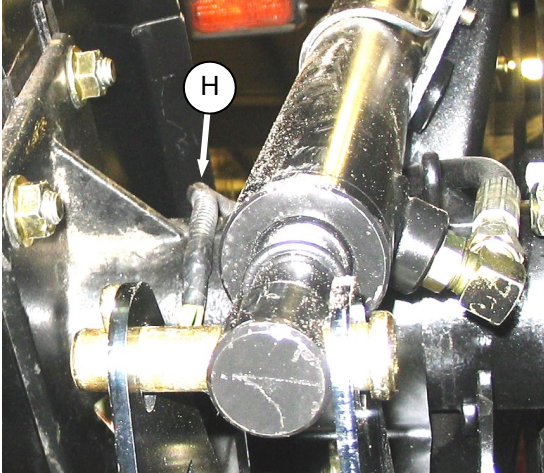

- f. Retrieve existing harness (H) from reel arm.

NOTE

Harness may be stored inside hose cover on top of reel arm.

- g. Proceed to procedure B, C, D or E for your particular combine.

SECTION II. ASSEMBLY – NORTH AMERICA

B. JOHN DEERE SENSOR INSTALLATION.

- a. Perform A. REMOVE COVER.
- b. Retrieve speed sensor kit from combine completion package.

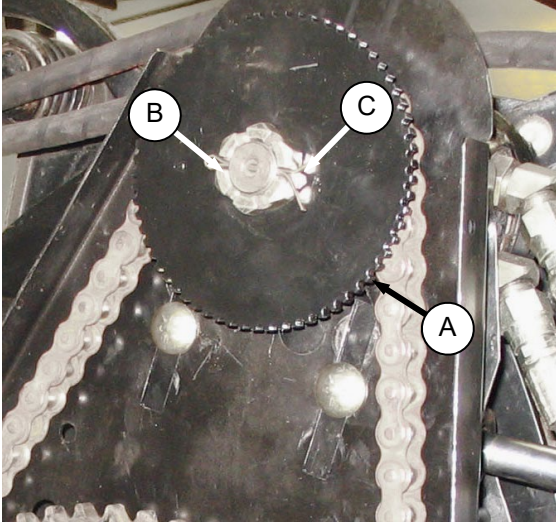

- c. Position speed sensor disc (A) on shaft and re-install slotted nut (B). Torque to 10-20 in·lbf (1.1-2.2 N·m).
- d. Install cotter pin (C). Tighten nut to next slot if required.

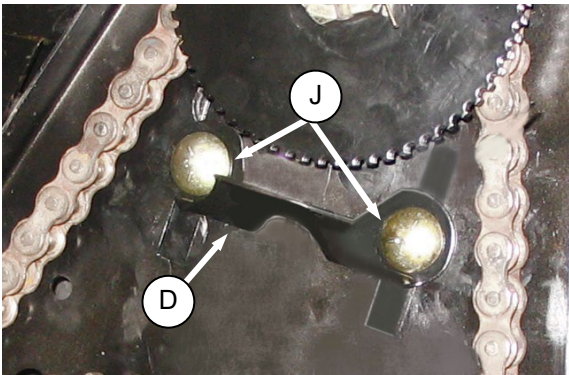

- e. Locate bracket (D) on chain case and re-install bolts (J). Torque to 75 ft·lbf (102 N·m).

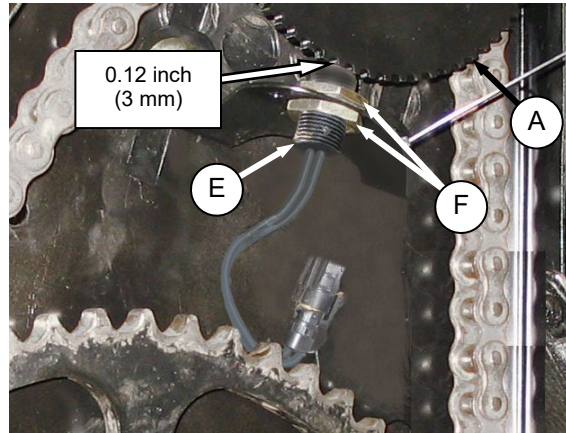

- f. Locate sensor (E) in bracket and adjust gap between sensor and disc (A) to 0.12 in. (3 mm) with nuts (F). Tighten nuts.

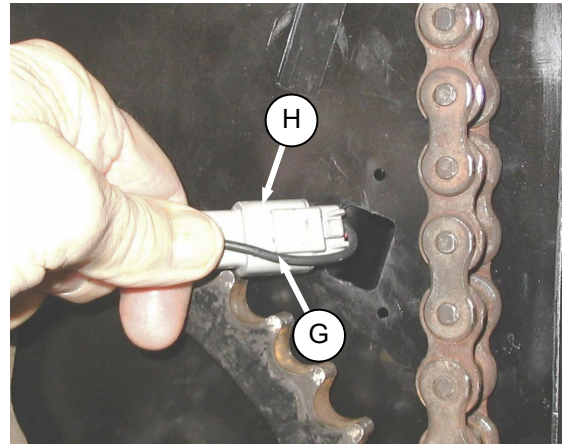

- g. Locate black wire (G) against harness connector (H) as shown and feed connector through hole in chain case.

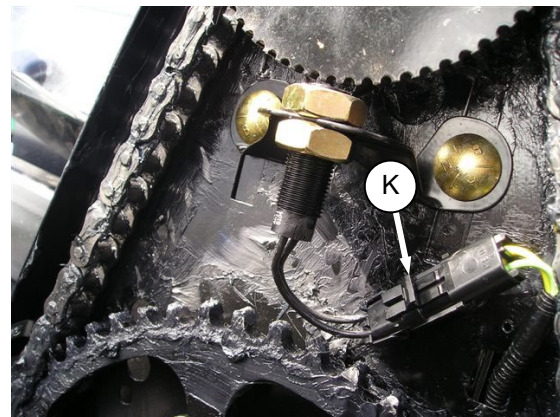

- h. Connect other end to sensor connector (K).

(continued next page)

SECTION II. ASSEMBLY – NORTH AMERICA

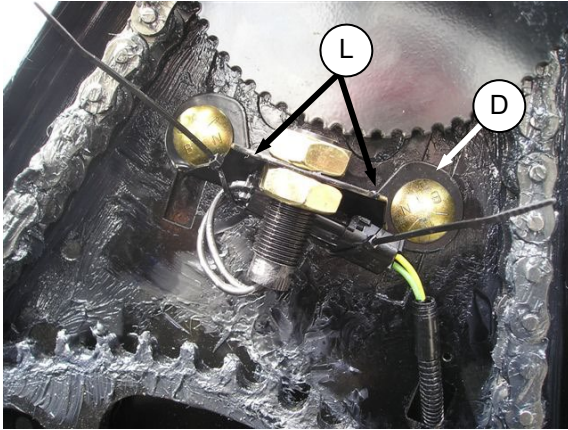

- i. Secure harness to support (D) with two cable ties (L).

IMPORTANT

Ensure harness is clear of chain and sprockets, and that motor can be moved up and down fully in slots without damaging harness.

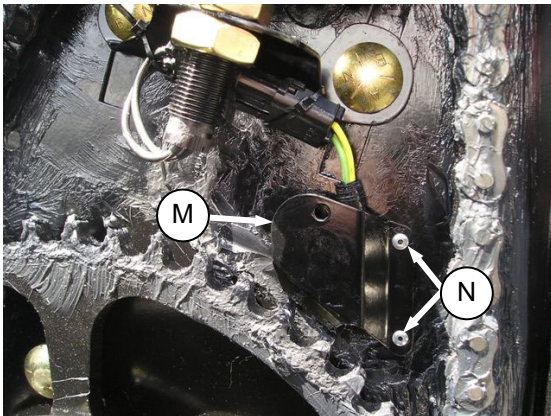

- j. Locate cover (M) over harness and attach to chain case with two rivets (N).
- k. Perform F. INSTALL COVER.

SECTION II. ASSEMBLY – NORTH AMERICA

C. LEXION 500 SERIES SENSOR INSTALLATION

- Perform A. REMOVE COVER.
- Retrieve speed sensor kit from combine completion package.

IMPORTANT

The following steps c. and d. are required to establish the amount of slack in the harness, and to determine the harness location on the cover, so that when the chain (A) is loosened, the harness or sensor will not be damaged.

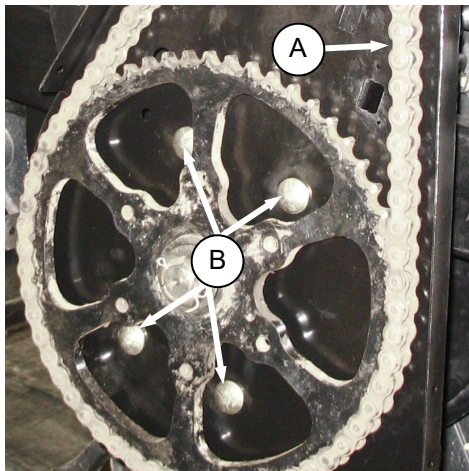

- Loosen four bolts (B)

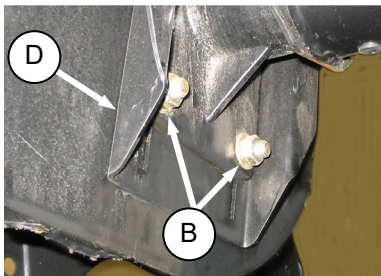
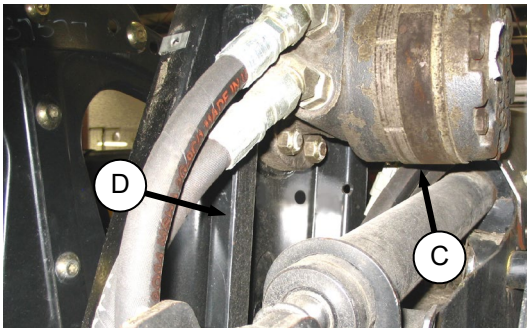

- Loosen drive chain (A) by sliding motor (C) and motor mount (D) down towards reel shaft.

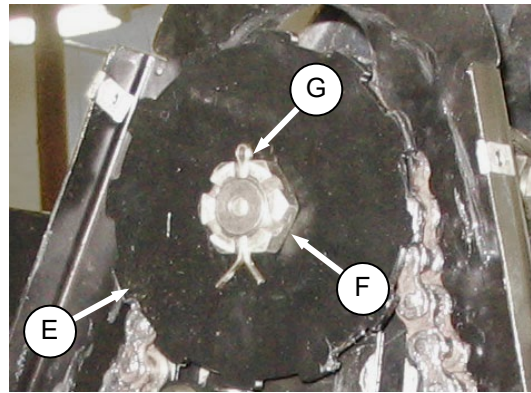

- Position speed sensor disc (E) on shaft and re-install slotted nut (F). Torque to 10-20 in·lbf (1.1-2.2 N·m).
- Install cotter pin (G). Tighten nut to next slot if required.

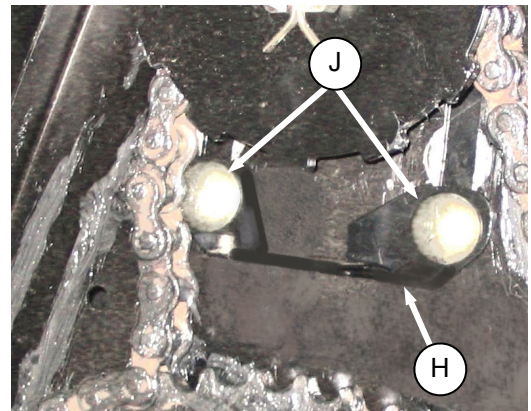

- Locate support (H) on chain case and re-install bolts (J). Torque to 75 ft·lbf (102 N·m).

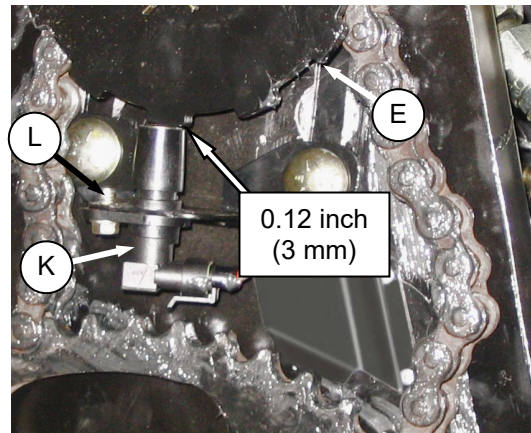

- Locate sensor (K) in support (H) and adjust gap between sensor and disc (E) to 0.12 inch (3 mm) by bending support. After gap is achieved, secure sensor with ¼"x0.5 self-tapping screw (L).

(continued next page)

SECTION II. ASSEMBLY – NORTH AMERICA

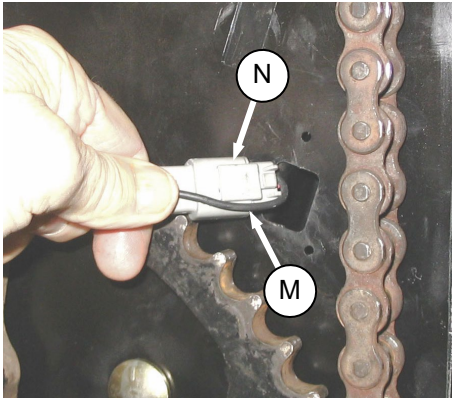

- i. Locate black wire (M) against harness connector (N) as shown and feed connector through hole in chain case.

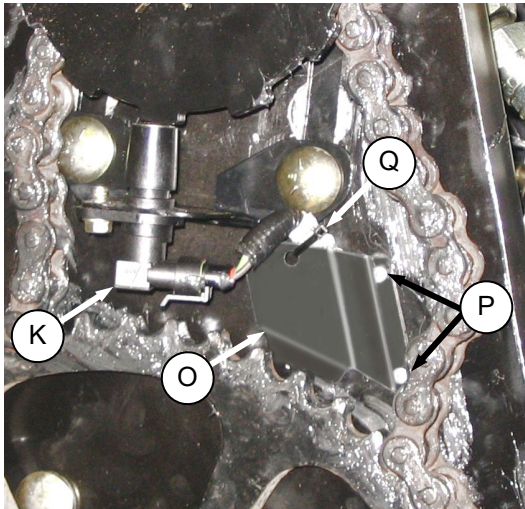

- j. Connect other end to sensor (K).
- k. Locate cover (O) over harness and attach to chain case with two rivets (P).
- l. Secure harness to cover (O) with cable tie (Q) exactly as shown.

IMPORTANT

Ensure harness is clear of chain and sprockets, and that motor can be moved up and down fully in slots without damaging harness.

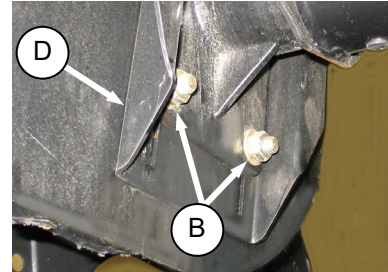
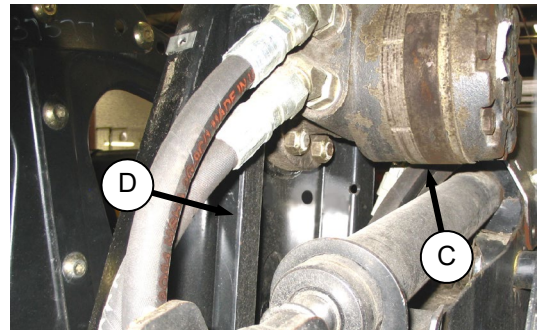

- m. Tighten drive chain by sliding motor (C) and motor mount (D) up away from reel shaft. Hand force should deflect the chain 1/8 inch (3 mm).

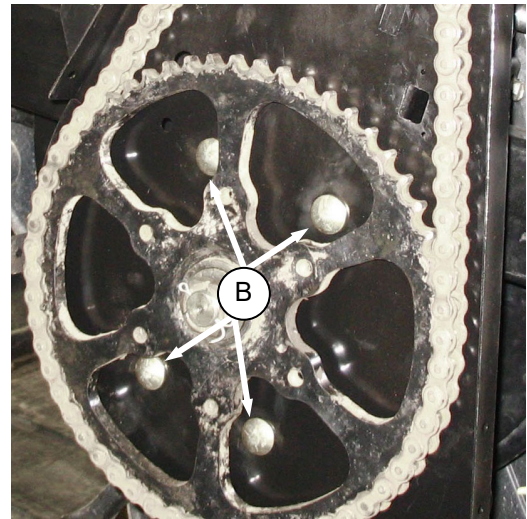

- n. Tighten bolts (B) to 75 ft·lbf (102 N·m).
- o. Perform F. INSTALL COVER.

SECTION II. ASSEMBLY – NORTH AMERICA

D. LEXION 400 SERIES SENSOR INSTALLATION

- Perform A. REMOVE COVER.
- Retrieve speed sensor kit from combine completion package.

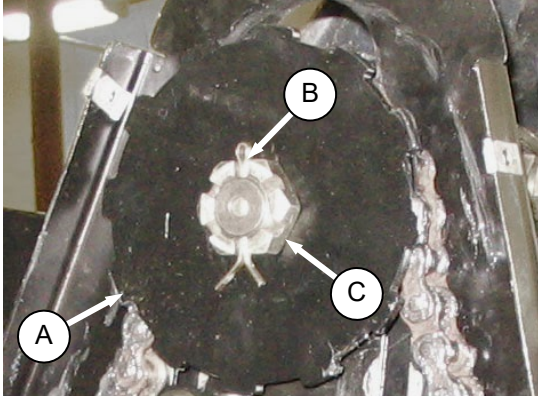

- Position speed sensor disc (A) on shaft and re-install slotted nut (B). Torque to 10-20 in-lbf (1.1-2.2 N·m).
- Install cotter pin (C). Tighten nut to next slot if required.

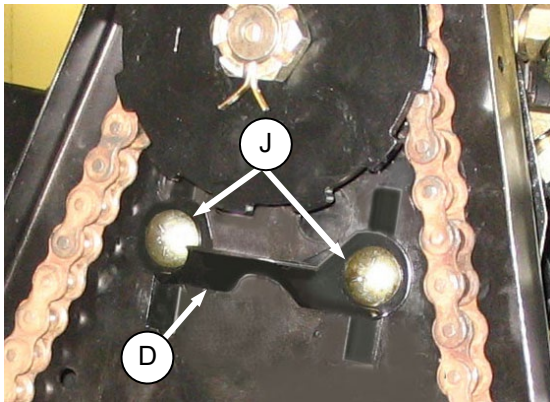

- Locate bracket (D) on chain case and re-install bolts (J). Torque to 75 ft·lbf (102 N·m).

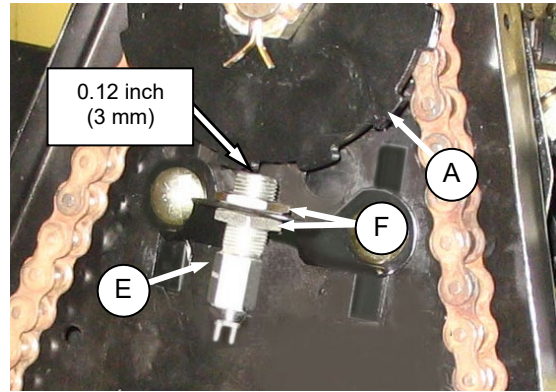

- Locate sensor (E) in bracket and adjust gap between sensor and disc (A) to 0.12 inch (3 mm) with nuts (F). Tighten nuts.

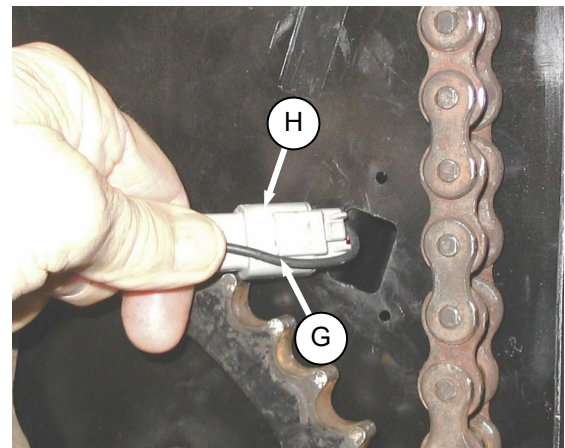

- Locate black wire (G) against harness connector (H) as shown and feed connector through hole in chain case.

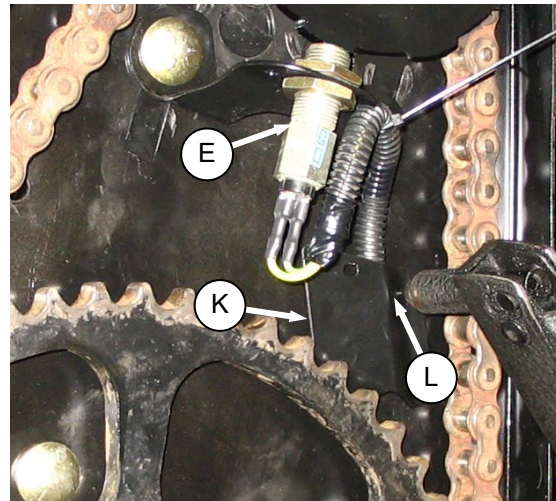

- Connect other end to sensor (E).
- Locate cover (K) over harness and attach to chain case with two rivets (L).

(continued next page)

SECTION II. ASSEMBLY – NORTH AMERICA

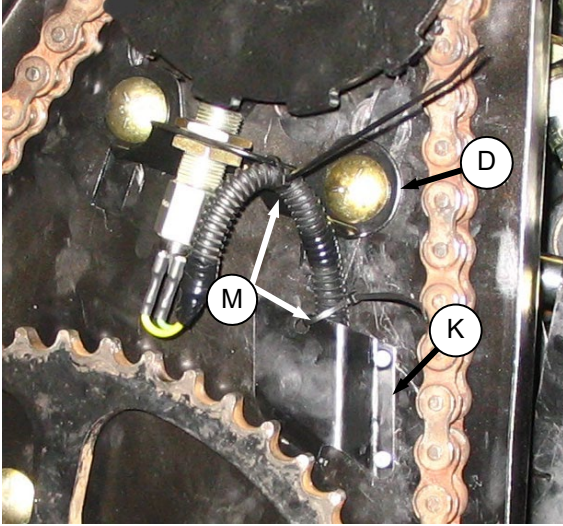

- j. Secure harness to support (D) and cover (K) with cable ties (M).

IMPORTANT

Ensure harness is clear of chain and sprockets, and that motor can be moved up and down fully in slots without damaging harness.

- k. Perform F. INSTALL COVER.

SECTION II. ASSEMBLY – NORTH AMERICA

E. AGCO SENSOR INSTALLATION

- Perform A. REMOVE COVER.
- Retrieve speed sensor kit from combine completion package.

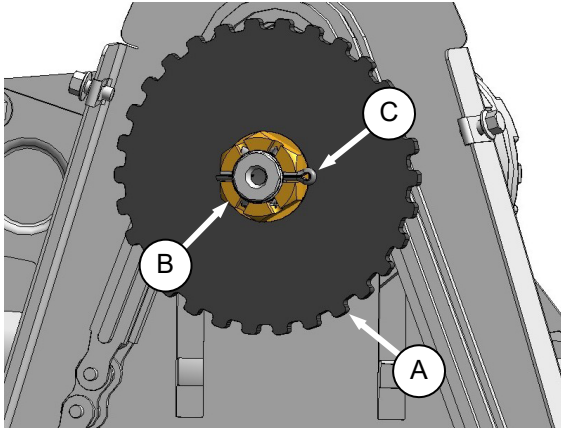

- Position speed sensor disc (A) on shaft and re-install slotted nut (B). Torque to 10-20 in·lbf (1.1-2.2 N·m).
- Install cotter pin (C). Tighten nut to next slot if required.

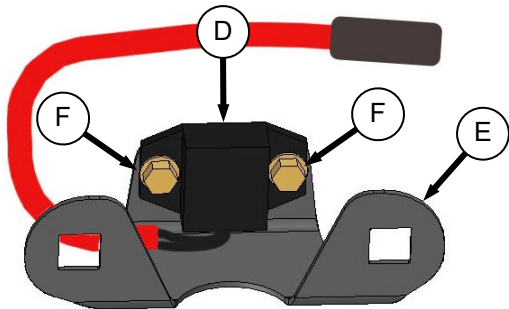

- Assemble sensor (D) to support (E) with self-tapping screws (F).

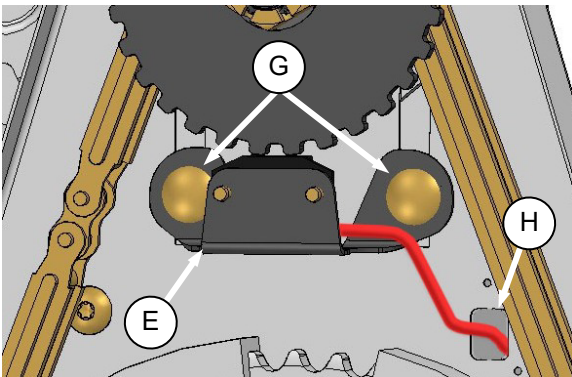

- Locate support (E) on chain case and re-install bolts (G). Torque to 75 ft·lbf (102 N·m).

- Route connector end of sensor harness through hole (H) in drive case as shown.

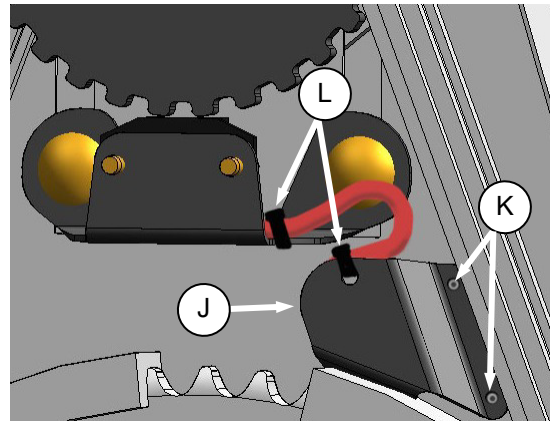

- Locate cover (J) over harness and attach to chain case with two rivets (K).
- Secure harness to cover (K) and support with cable ties (L) exactly as shown.

IMPORTANT

Ensure harness is clear of chain and sprockets, and that motor can be moved up and down fully in slots without damaging harness.

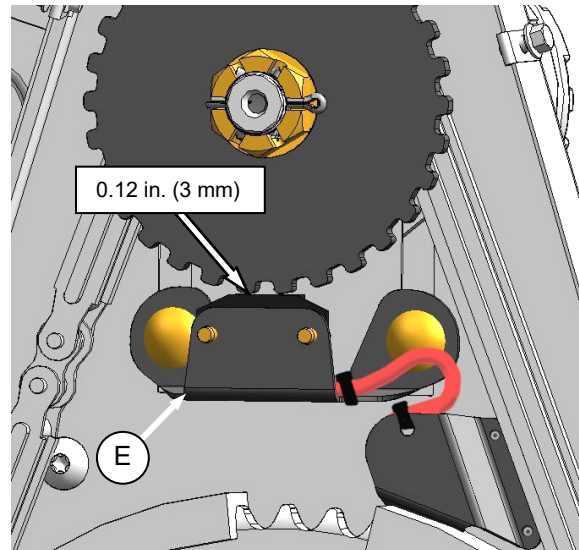

- Adjust gap between sensor and disc to 0.12 inch (3 mm) by bending support (E).

SECTION II. ASSEMBLY – NORTH AMERICA

F. INSTALL COVER

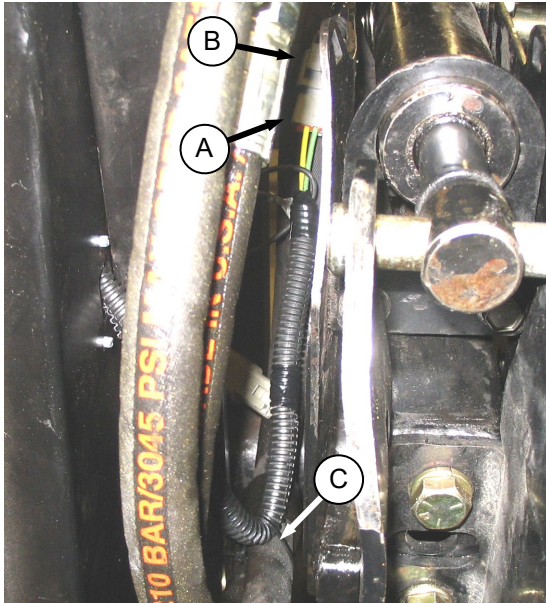

- a. Attach sensor connector (A) to existing harness (B) behind chain case.
- b. Secure sensor harness to hose with cable tie (C).

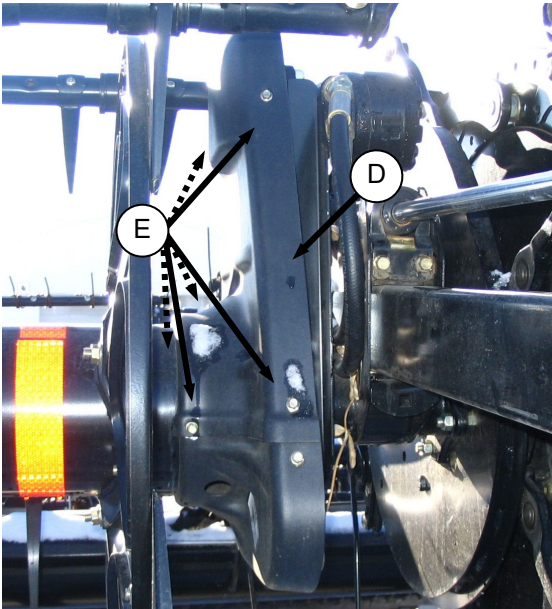

- c. Position cover (D) and install six screws (E).

STEP 3. INSTALL OPTIONS

Retrieve kits supplied as options with the header and install in accordance with installation instructions supplied in each kit.

SECTION II. ASSEMBLY – NORTH AMERICA

STEP 4. SET-UP ADAPTER

A. TOP LINK KIT

Some combine models require shorter center link components to ensure clearance to the combine cab. To avoid damage to your combine, lift feeder slowly and check clearance between cab and header center link. If clearance is inadequate, order short center link components. Installation instructions are included.

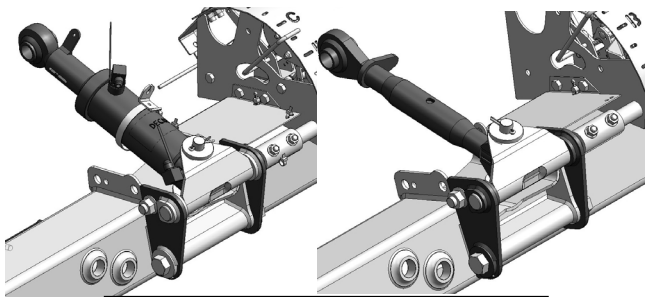

SHORT CENTER-LINK ASSEMBLIES

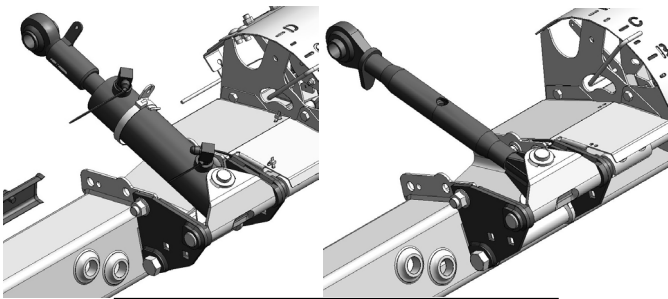

NORMAL CENTER-LINK ASSEMBLIES

The following combine models have been identified for requiring the shorter center link components:

- Case IH 5088, 6088, and 7088 Without Stone Traps.
- Gleaner R Series.

Contact your MacDon distributor for ordering information.

B. FLIGHTING EXTENSIONS

Flighting extension kits may have been supplied with your header to improve feeding in certain crops such as rice. They are not recommended in cereal crops.

APPLICABLE COMBINES: All except New Holland CR960, 9060, 970, 9070, and 9080. If necessary, remove auger flighting extensions as follows.

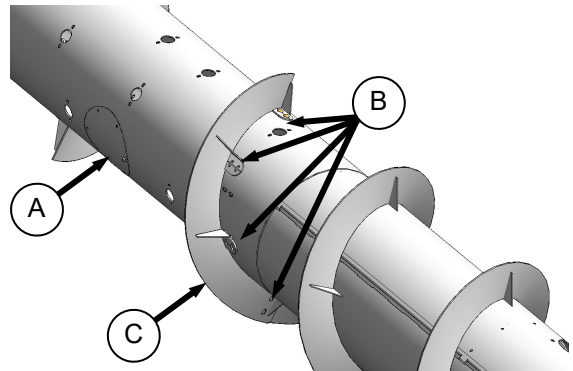

- Remove access cover (A).
- Remove eight bolts (B), washers, and nuts that secure flighting extension (C) to auger and remove extension.
- Repeat for other flighting extension.
- Re-install access cover (A).

C. STRIPPER BARS

Stripper bar kits may have been supplied with your header to improve feeding in certain crops such as rice. They are not recommended in cereal crops.

APPLICABLE COMBINES: All except New Holland CR960, 9060, 970, 9070, and 9080. If necessary, remove auger stripper bars as follows:

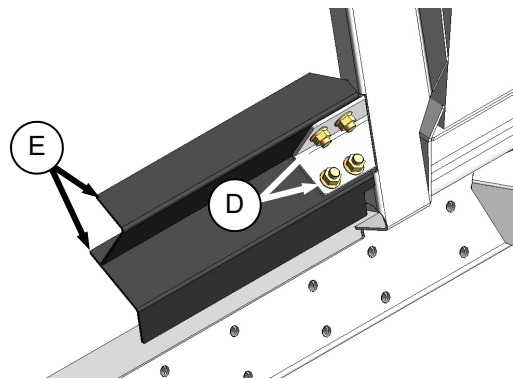

- Remove four bolts (D) and nuts securing bars (E) to adapter frame and remove bars.
- Repeat for opposite set of stripper bars.

SECTION II. ASSEMBLY – NORTH AMERICA

D. CR FEEDER DEFLECTORS

For New Holland CR 960, 9070, and 9080 combines, feeder kits have been installed on the adapter at the factory to improve feeding into the feeder house. They may also have been installed as an option on older machines. If necessary, they can be removed.

CA20 adapters for the CR Models listed have short feeder kits installed at the factory. Long feeder kits are provided for narrow feeder house combines and are dealer installed to replace the short feeder kits.

COMBINE MODEL	FEEDER HOUSE SIZE	FEEDER KIT SIZE
CR970, 9070, 9080	Wide	Short 200 mm
CR960, 9060, 940, 9040	Narrow	Long 325 mm

If required, replace the feeder deflectors as follows:

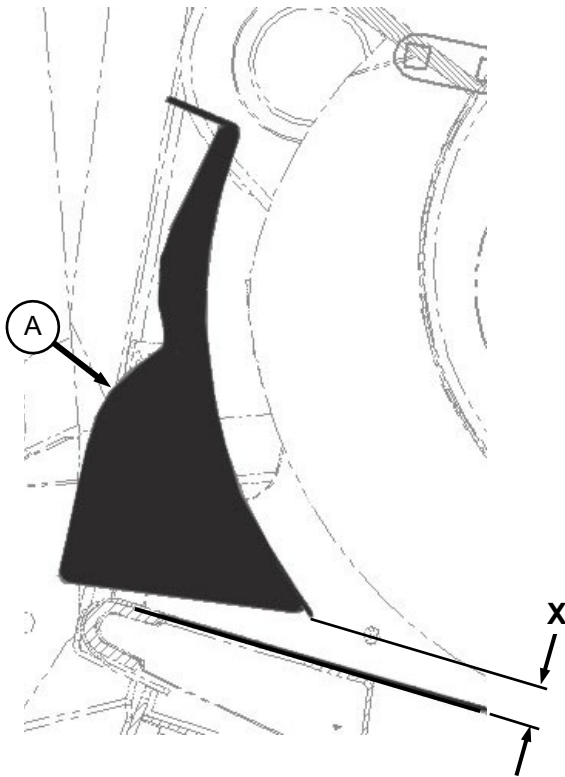

- Determine position of existing deflector (A) by measuring gap "X" between deflector forward edge and pan.

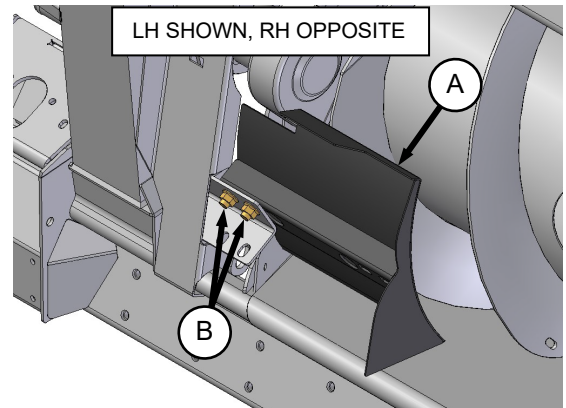

- Remove two bolts (B) and nuts securing deflector (A) to adapter frame and remove deflector.
- Position replacement deflector and secure with bolts (B) and nuts. Maintain dimension "X" from existing deflector for replacement deflector.
- Repeat for opposite deflector.
- After attaching header to combine, extend center link fully and check gap between deflector and pan. Maintain 7/8 in. (22 mm) +/- 1/8 in. (3 mm).

SECTION II. ASSEMBLY – NORTH AMERICA

STEP 5. ATTACH TO COMBINE

Refer to specific section for your combine.

CASE IH	SECTION A
CASE IH 23, 25 SERIES	SECTION B
JD 60, 70 SERIES	SECTION C
JOHN DEERE 50 SERIES	SECTION D
LEXION	SECTION E
NEW HOLLAND	SECTION F
AGCO	SECTION G

IMPORTANT

Ensure applicable functions (AHHC, Draper Header Option, Hydraulic Center Link Option, Hydraulic Reel Drive, etc.) are enabled on the combine and combine computer. Failure to do so may result in improper header operation.

IMPORTANT

Some combine models require shorter center link components to ensure clearance to the combine cab. To avoid damage to your combine, lift feeder slowly and check clearance between cab and header center link. If clearance is inadequate, order short center link components. Installation instructions are included. See STEP 4 SET-UP ADAPTER.

A. CASE IH

Case IH 7010, 8010, 7120, 8120, 5088, 6088, 7088.

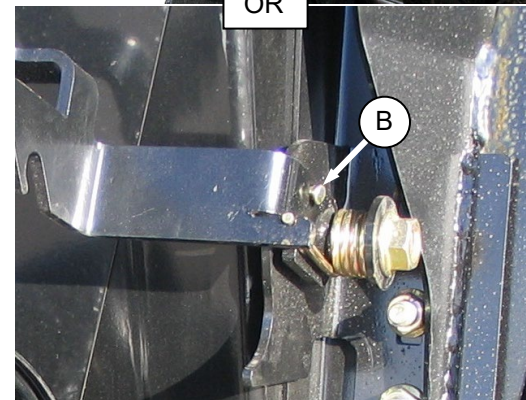
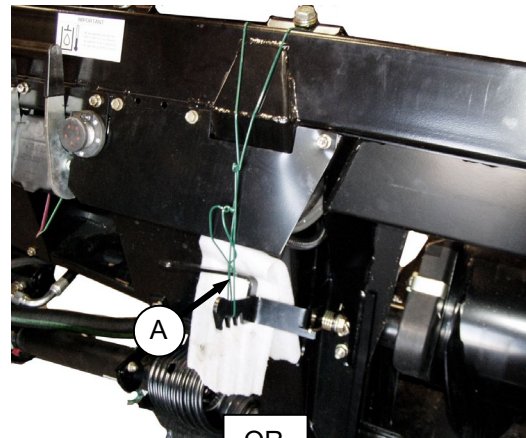

- Remove shipping wire attaching latch (A) to adapter frame, OR remove shipping pin (B). Retain pin for future installation.

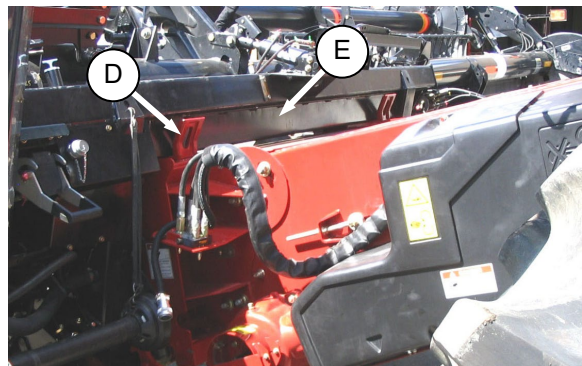

- Slowly drive combine up to header until feeder house saddle (D) is directly under the adapter top cross member (E).
- Raise feeder house to lift header slightly, ensuring feeder saddle is properly engaged in adapter frame.

(continued next page)

SECTION II. ASSEMBLY – NORTH AMERICA



CAUTION

Stop engine and remove key from ignition before leaving operator's seat for any reason. A child or even a pet could engage an idling machine.

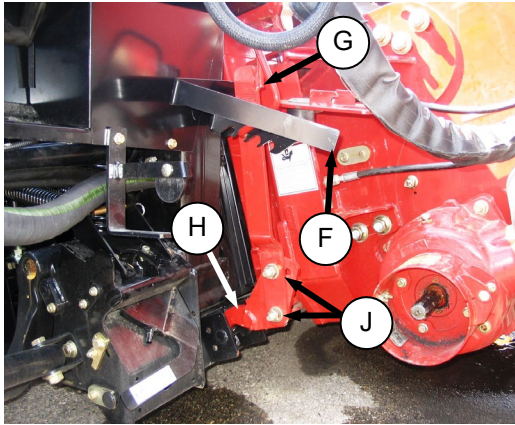

- d. Lift latch (F) on adapter at left side of feeder house and push handle (G) on combine to engage locks (H) on both sides of the feeder house.
- e. Push down on latch (F) so that slot in latch engages handle (G) to lock it in place.
- f. If lock (H) does not fully engage pin on adapter when latch (F) and handle (G) are engaged, loosen bolts (J) and adjust lock as required. Re-tighten bolts.
- g. Remove blocks from under cutterbar.
- h. Start engine and lower header. Shutdown combine.
- i. Connect combine hydraulic quick coupler to

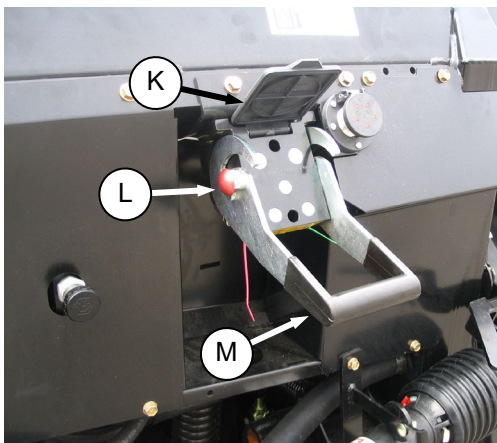

receptacle on adapter as follows:

1. Open cover (K).
2. Push in lock button (L) and pull handle (M) to position approximately as shown.

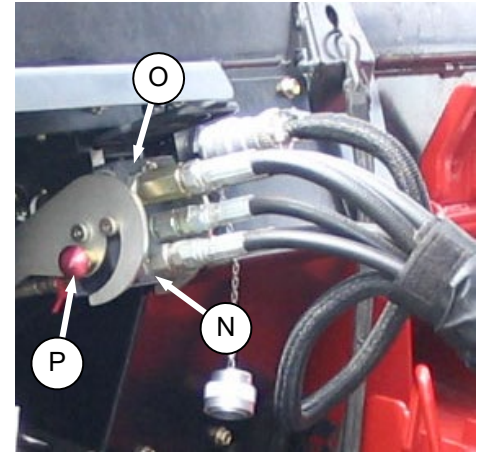

3. Remove coupler (N) from combine and clean coupler.
4. Position coupler (N) onto adapter receptacle (O) and push handle to engage coupler pins into receptacle.
5. Push handle to closed position until lock button (P) snaps out.

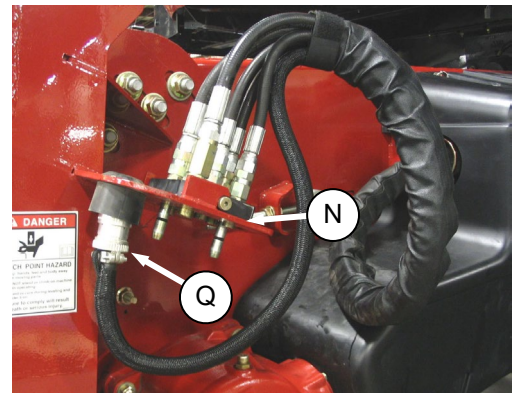

- j. Remove electrical connector (Q) from storage cup on combine.

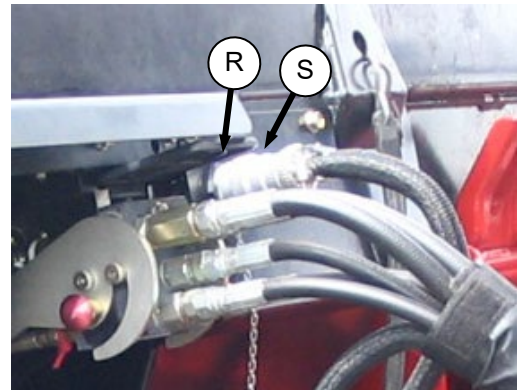

- k. Open cover on adapter electrical receptacle (R), align lugs on connector (S) with slots in adapter receptacle, push connector onto receptacle and turn collar on connector to lock it in place.

(continued next page)

SECTION II. ASSEMBLY – NORTH AMERICA

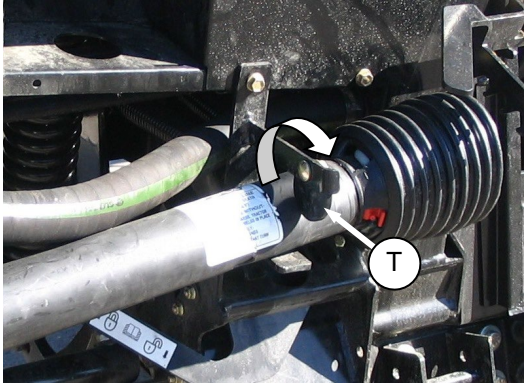

- I. Rotate disc (T) on adapter driveline storage hook and remove driveline from hook.

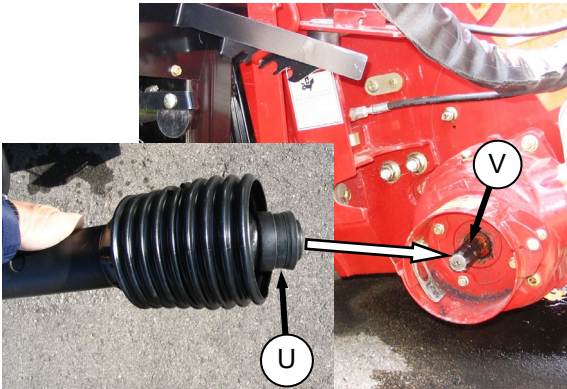

- m. Pull back collar (U) on end of drive line and push onto combine output shaft (V) until collar locks.
- n. Proceed to STEP 6. REMOVE SHIPPING SUPPORTS (page 43).

SECTION II. ASSEMBLY – NORTH AMERICA

B. CASE IH 23, 25 SERIES

2300, 2500 Series

a. Attach header to combine as follows:

Sliding Pin System

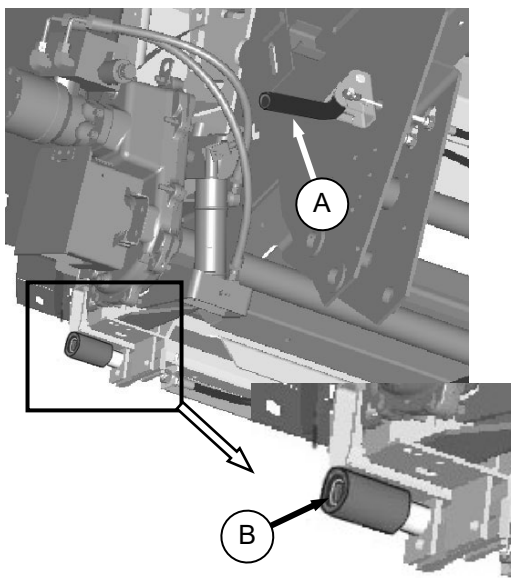

1. Move handle (A) on left side of feeder house to up position to retract both pins (B) at lower corners of feeder house.

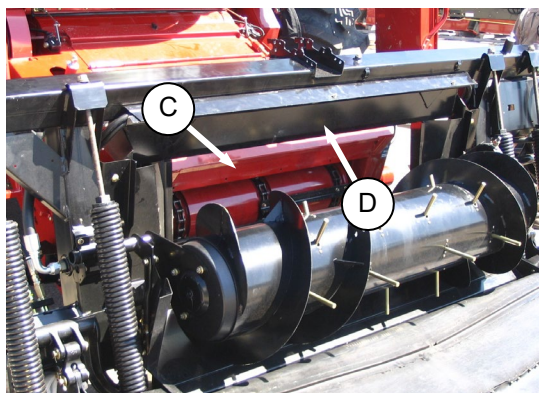

2. Slowly drive combine up to header until feeder house saddle (C) is directly under the adapter top cross member (D).
3. Raise feeder house saddle slightly to lift header, ensuring feeder saddle is properly engaged in adapter frame.

4. Lower handle (A) to engage pins (B) into adapter.

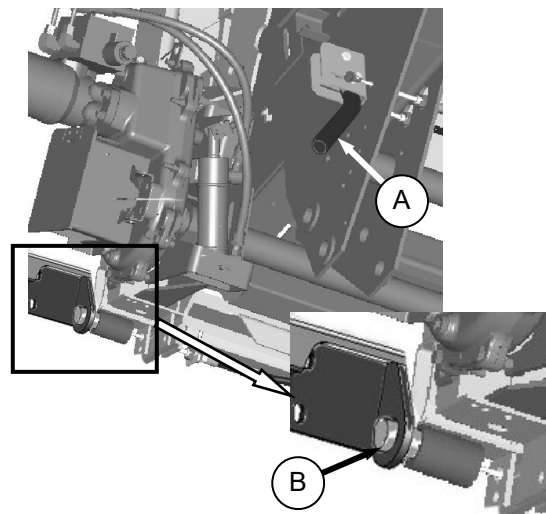

5. Proceed to step b.

Latch System



WARNING

To avoid bodily injury or death from unexpected start-up or fall of raised attachment; stop engine, remove key and engage lift cylinder stop before proceeding with hook-up.

1. Slowly drive combine up to header until feeder house saddle (C) is directly under the adapter top cross member (D). See illustration opposite.
2. Raise feeder house fully and engage combine lift cylinder locks.

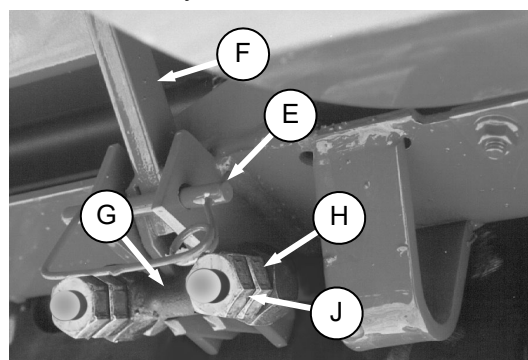

3. Remove pin (E) and lower latch handle (F) (one on each side of feeder house underside) to hook latch (G).
4. Lift handle to overcenter position to lock. Requires 40-50 lbf (180-220 N) to move handle overcenter. Adjust nuts (H) on U-bolts to vary force required on handle.

(continued next page)

SECTION II. ASSEMBLY – NORTH AMERICA

5. Tighten jam-nuts (J) when force is correct.
 6. Install pin (E) as shown to secure latch handle in locked position.
 7. Remove combine lift cylinder locks and lower header to ground.
- b. Connect combine hydraulics to adapter as follows:

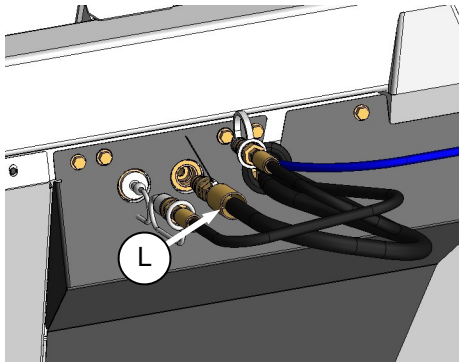
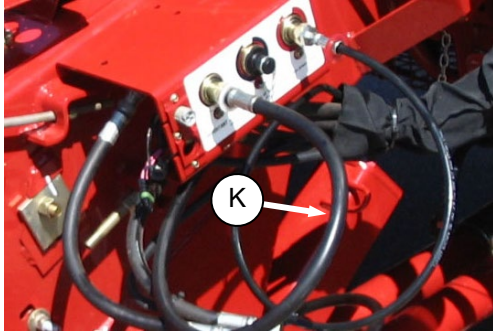

1. Disconnect reel drive hoses (K) and (L) (white discs) from combine and adapter receptacles.

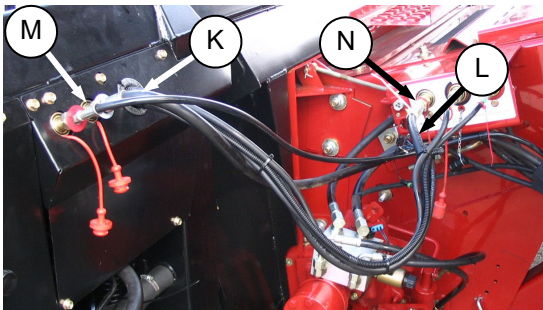

2. Connect hose (K) from combine to adapter coupler (M).
3. Connect hose (L) from the adapter to the combine coupler (N).

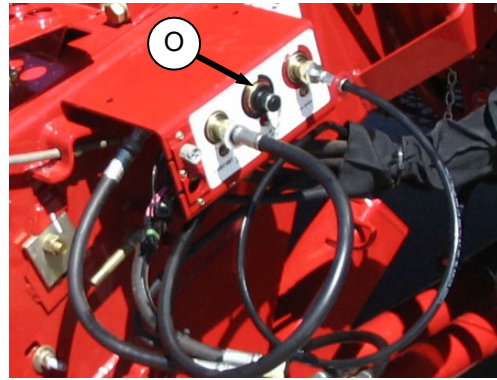

4. Remove plug from reel lift coupler (O) (black disc) on combine.

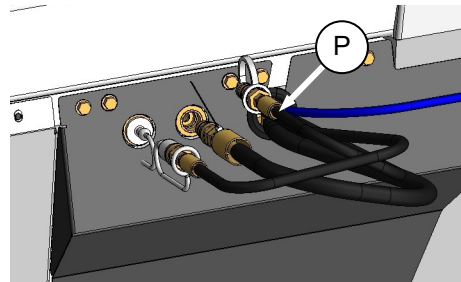

5. Remove red dust cap from reel lift hose (P) on adapter and connect hose to combine coupler (O).

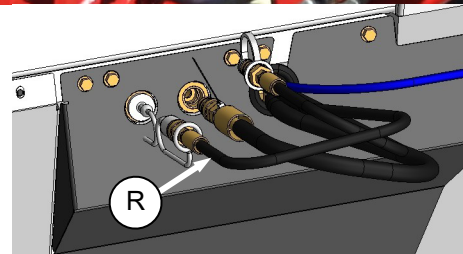

6. Disconnect reel fore/aft hoses (Q) and (R) (red discs) from combine and adapter receptacles.

(continued next page)

SECTION II. ASSEMBLY – NORTH AMERICA

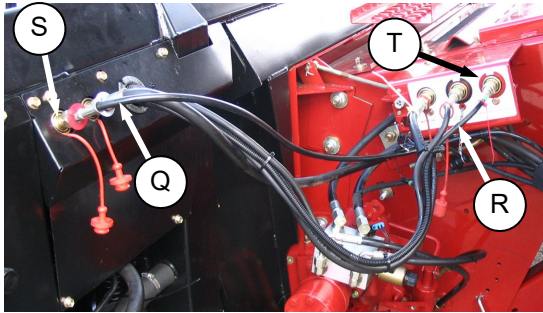

7. Connect hose (Q) from combine to adapter coupler (S).
8. Connect hose (R) from the adapter to the combine coupler (T).

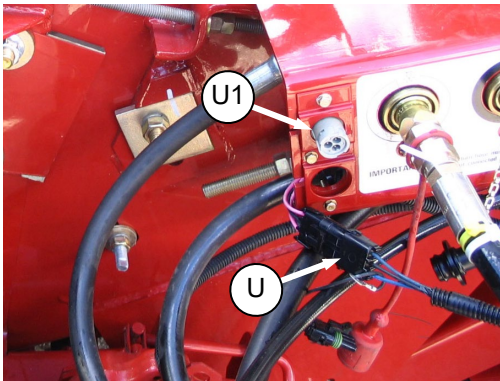

- c. Connect adapter electrical harness (U) to combine electrical connector, and if applicable connect AHHC wire harness at U1.

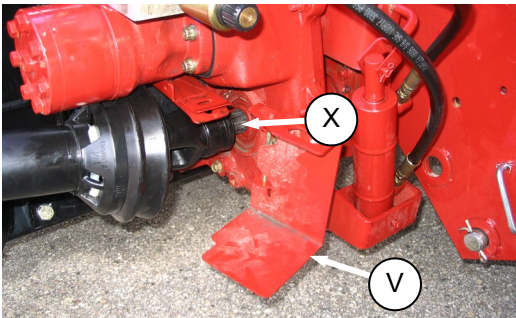

- d. Open guard (V) at combine output shaft.

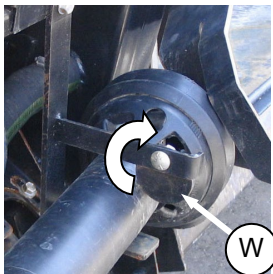

- e. Rotate disc (W) on adapter drive-line storage hook and remove drive-line from hook.

- f. Pull back collar on end of drive line and push onto combine output shaft (X) until collar locks. Close guard (V).

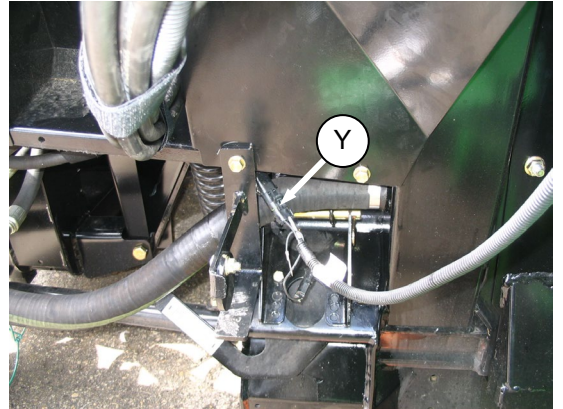

- g. If adapter is equipped with reel fore-aft/header tilt selector, connect harness (Y) to combine.

SECTION II. ASSEMBLY – NORTH AMERICA

C. JOHN DEERE 60, 70 SERIES

Models Contour Master, Level Land.

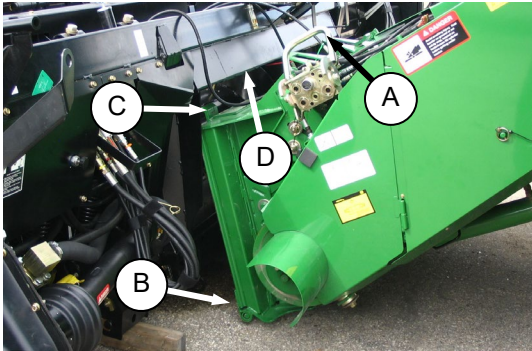

- Push handle (A) on combine coupler toward feeder house to retract pins (B) at bottom corners of feeder house.
- Slowly drive combine up to header until feeder house saddle (C) is directly under the adapter top cross member (D).
- Raise feeder house to lift header, ensuring feeder saddle is properly engaged in adapter frame.
- Position header slightly off the ground.



CAUTION

Stop engine and remove key from ignition before leaving operator's seat for any reason. A child or even a pet could engage an idling machine.

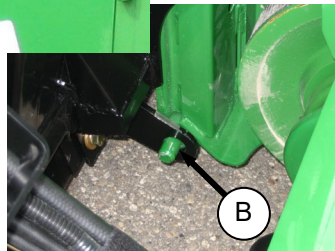
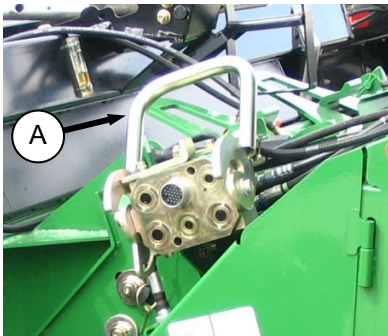

- Pull handle (A) to engage pins (B) in adapter.

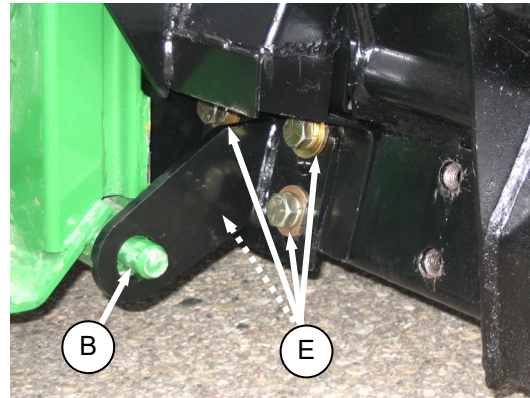

- Check that bolts (E) on adapter brackets are tight.
- If pins (B) do not fully engage adapter brackets, loosen bolts (E) and adjust bracket as required. Re-tighten bolts.
- Remove blocks from under cutterbar.
- Start engine and lower header.

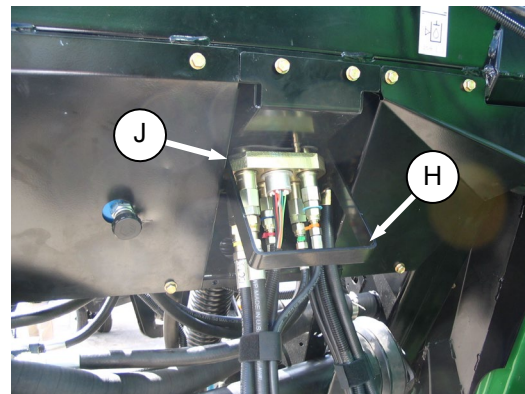

- Pull handle (H) on adapter to release coupler (J) from storage position. Remove coupler and push handle back into adapter to store.

(continued next page)

SECTION II. ASSEMBLY – NORTH AMERICA

JOHN DEERE 60, 70 SERIES (Cont'd)

k. Attach coupler (J) to combine as follows:

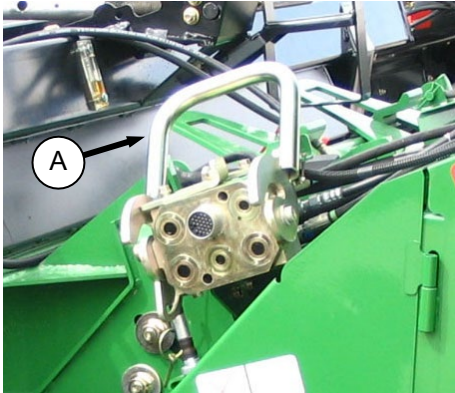

1. Handle (A) should be in the nearly up position. Clean receptacle.

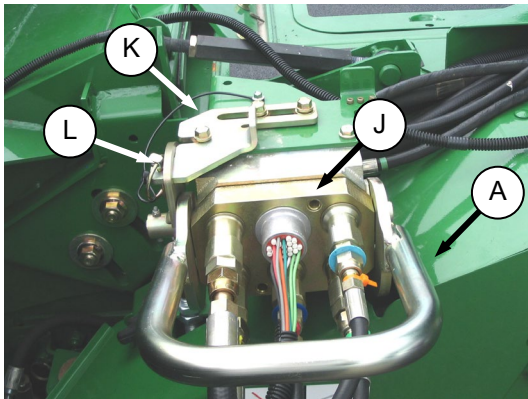

2. Locate coupler (J) onto receptacle and pull handle (A) so that lugs on coupler are engaged into handle.
3. Pull handle to full horizontal position as shown.
4. Slide latch (K) to lock handle in position and secure with lynch pin (L).

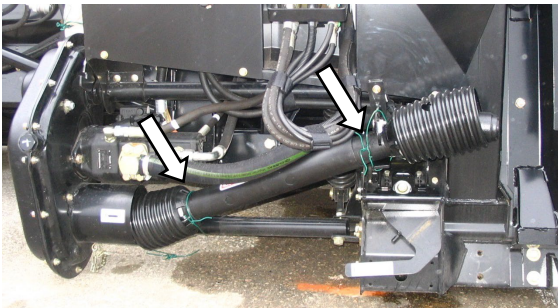

l. Remove shipping wire from driveline.

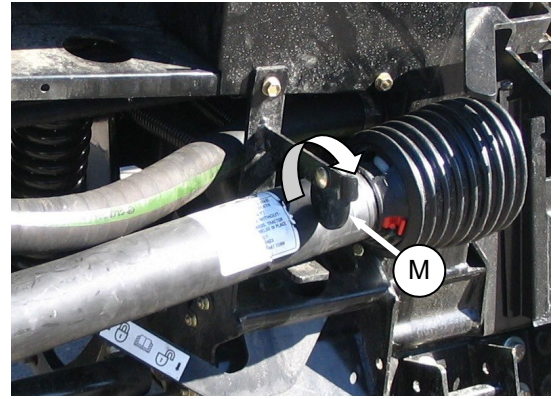

- m. Rotate disc (M) on adapter driveline storage hook and remove driveline from hook.

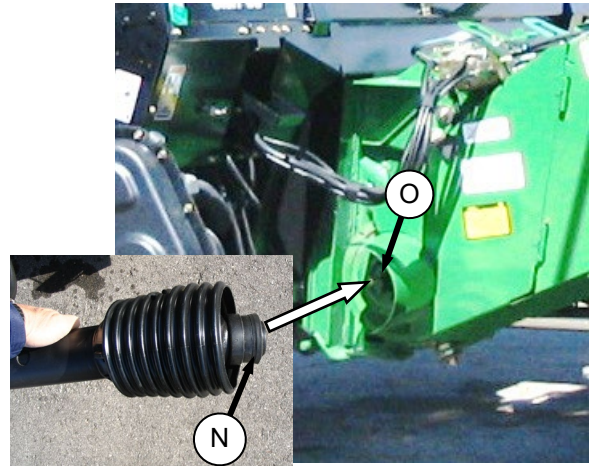

- n. Pull back collar (N) on end of drive line and push onto combine output shaft (O) until collar locks.

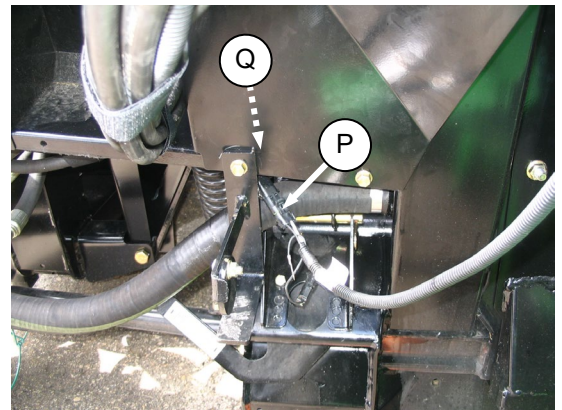

- o. If adapter is equipped with reel fore-aft/header tilt selector, connect harness (P) to combine.

NOTE

Connector (P) may need to be retrieved from hydraulics compartment access hole (Q).

- p. Proceed to STEP 6. REMOVE SHIPPING SUPPORTS (page 35).

SECTION II. ASSEMBLY – NORTH AMERICA

D. JOHN DEERE 50 SERIES

Models Contour Master, Level Land.

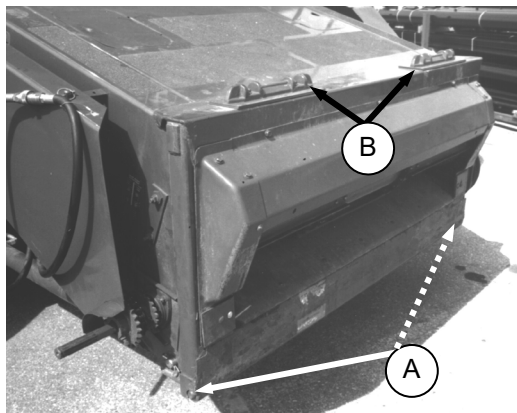

- a. Retract pins (A) at bottom corners of feeder house.

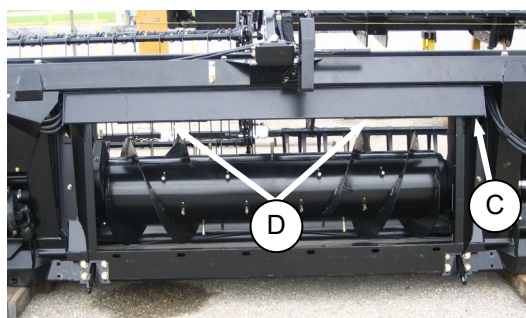

- b. Slowly drive combine up to header until feeder house lift lugs (B) are directly under the adapter top cross member (C).
- c. Raise feeder house to lift header, ensuring lift lugs (B) are properly engaged in adapter frame sockets (D).
- d. Position header slightly off the ground.



CAUTION

Stop engine and remove key from ignition before leaving operator's seat for any reason. A child or even a pet could engage an idling machine.

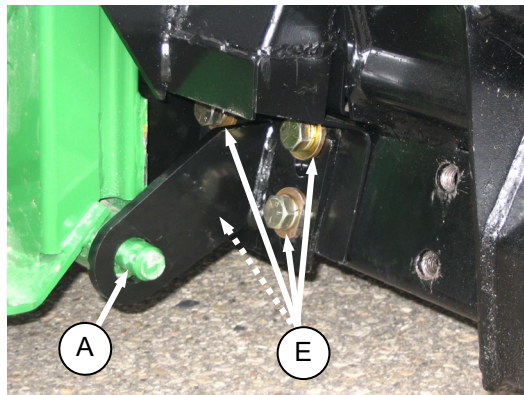

- e. Engage pins (A) in adapter.
- f. Check that bolts (E) on adapter brackets are tight.
- g. If pins (A) do not fully engage adapter brackets, loosen bolts (E) and adjust bracket as required. Re-tighten bolts.
- h. If required, remove blocks from under cutterbar.
- i. Start engine and lower header.
- j. At left side of combine feeder house, retrieve reel aft hose, reel lift hose and electrical harness.

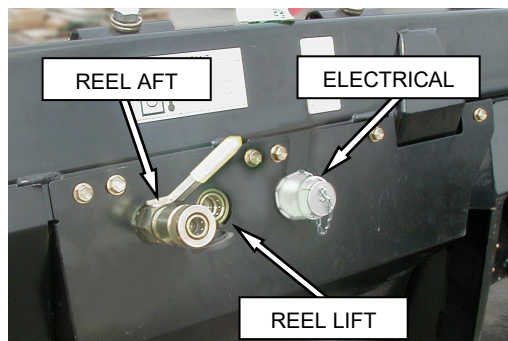

- k. Clean couplers and attach as shown above.
- l. At right side of feeder house, disconnect reel drive hoses and retrieve reel fore hose.

(continued next page)

SECTION II. ASSEMBLY – NORTH AMERICA

JOHN DEERE 50 SERIES (Cont'd)

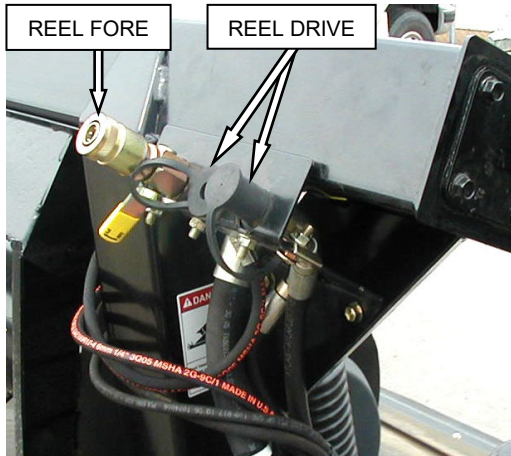

m. Clean couplers and attach as shown above.

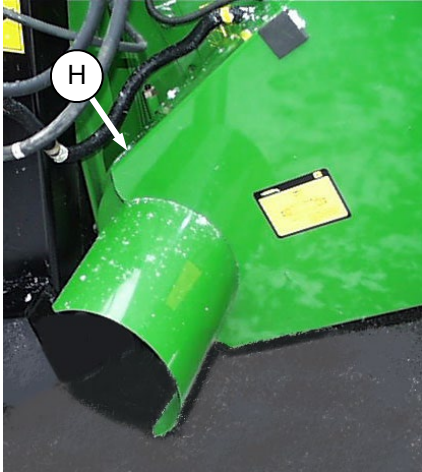

n. Open shield (H) on combine.

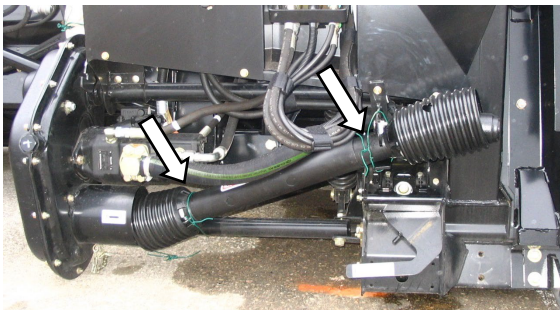

o. Remove shipping wire securing driveline to adapter.

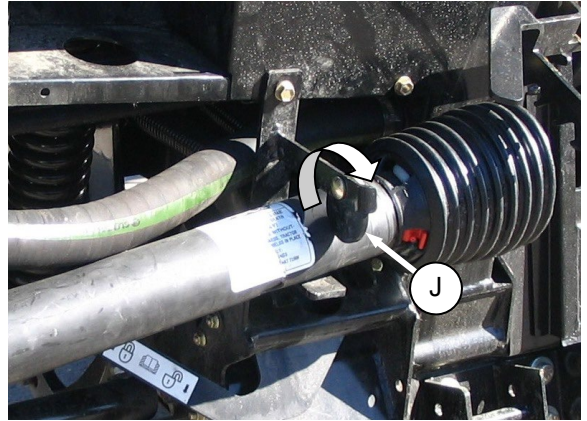

p. Rotate disc (J) on adapter driveline storage hook and remove driveline from hook.

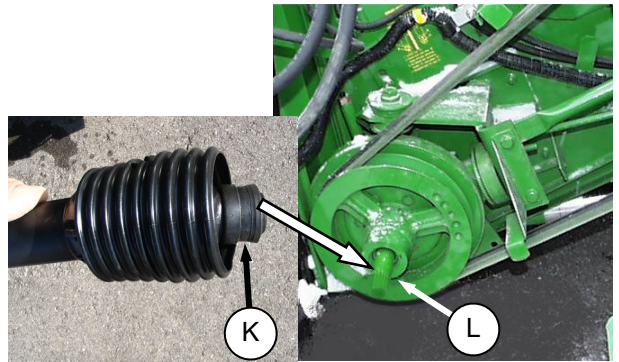

q. Pull back collar (K) on end of drive line and push onto combine output shaft (L) until collar locks.

r. Close drive shield (H) on combine.

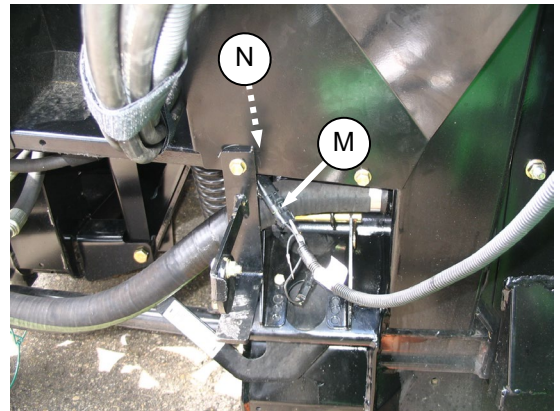

s. If adapter is equipped with reel fore-aft/header tilt selector, connect harness (M) to combine.

NOTE

Connector (M) may need to be retrieved from hydraulics compartment access hole (N).

t. Proceed to STEP 6. REMOVE SHIPPING SUPPORTS (page 35).

SECTION II. ASSEMBLY – NORTH AMERICA

E. LEXION

400, 500(R)

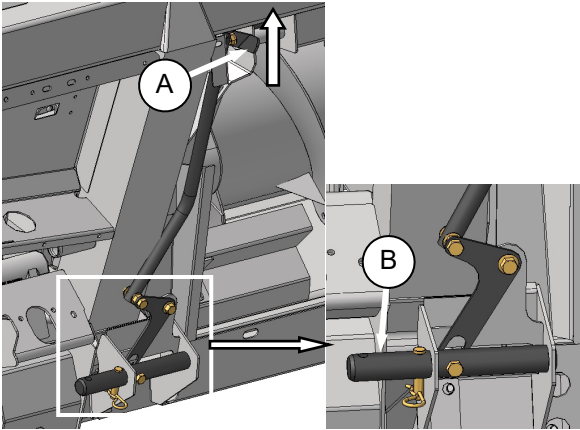

- Handle (A) on the CA20 adapter should be in raised position and pins (B) at bottom corners of adapter retracted.
- Slowly drive combine up to header until feeder house is directly under the adapter top cross member.

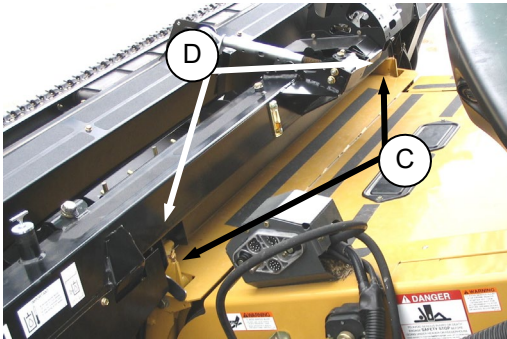

- Raise feeder house to lift header, ensuring feeder house posts (C) are properly engaged in adapter frame (D).
- Position header slightly off the ground.



CAUTION

Stop engine and remove key from ignition before leaving operator's seat for any reason. A child or even a pet could engage an idling machine.

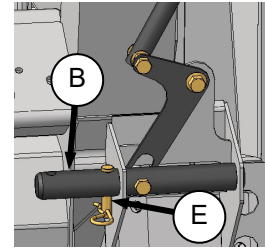

- Remove locking pin (E) from adapter pin (B).

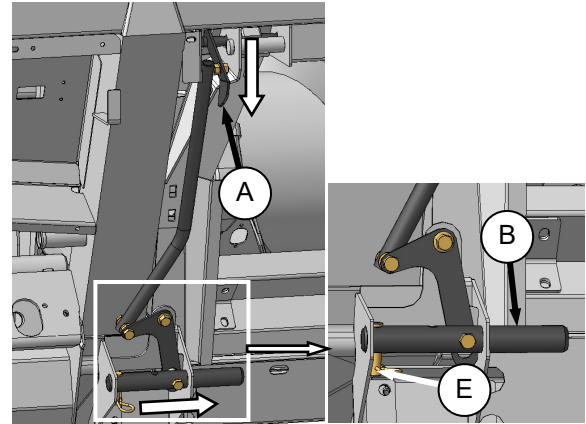

- Lower handle (A) to engage adapter pins into feeder house. Re-insert locking pin (E) and secure with hairpin.
- Remove blocks from under cutterbar.
- Start engine and lower header. Shut down the combine.

(continued next page)

SECTION II. ASSEMBLY – NORTH AMERICA

LEXION (Cont'd)

i. Connect hydraulic hoses as follows:

500 Series

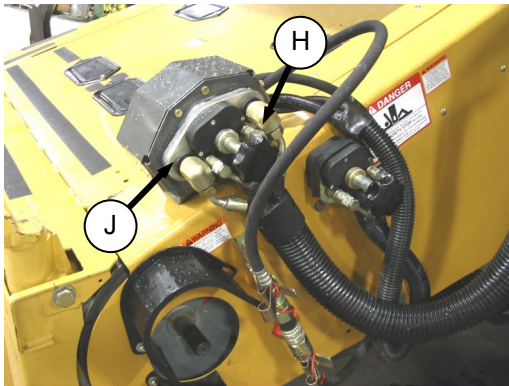

1. Unscrew knob (H) on combine coupler (J) to release coupler from combine receptacle.

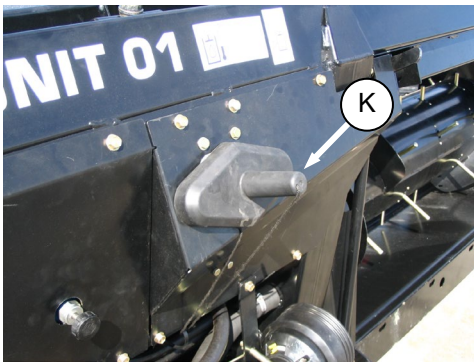

2. Remove cover (K) from adapter receptacle.

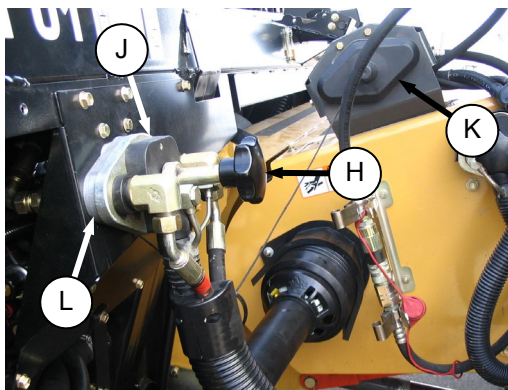

3. Locate coupler (J) onto adapter receptacle (L) and turn knob (H) to secure coupler to receptacle.
4. Place cover (K) on combine receptacle.
5. Proceed to step j.

400 Series

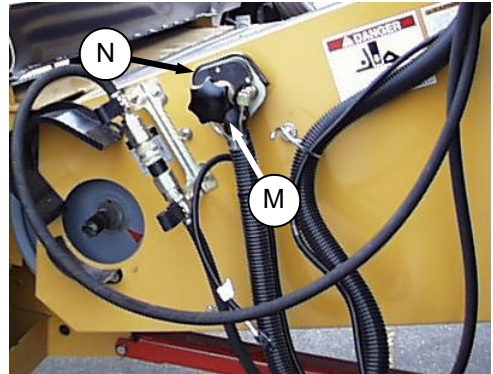

1. Unscrew knob (M) on combine coupler (N) to release coupler from combine receptacle.

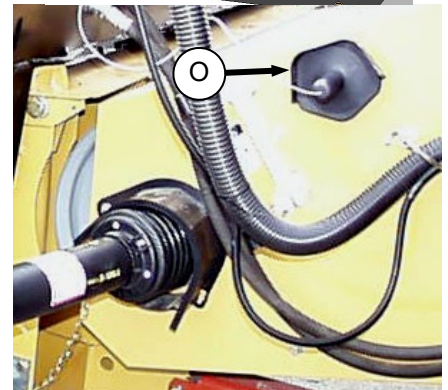
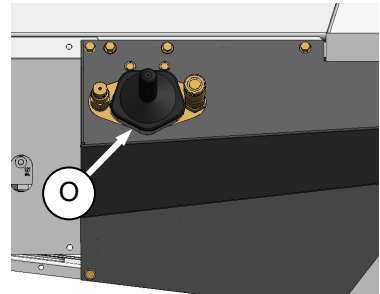

2. Remove cover (O) from adapter receptacle and place on combine receptacle.

(continued next page)

SECTION II. ASSEMBLY – NORTH AMERICA

LEXION (Cont'd)

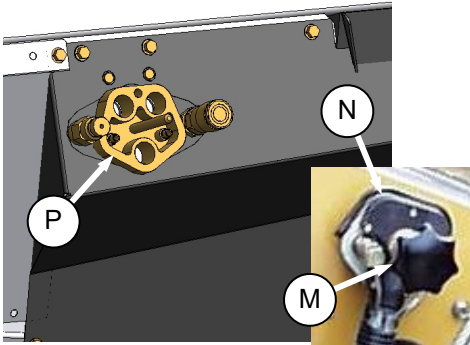

3. Locate coupler (N) onto adapter receptacle (P) and turn knob (M) to secure coupler to receptacle.

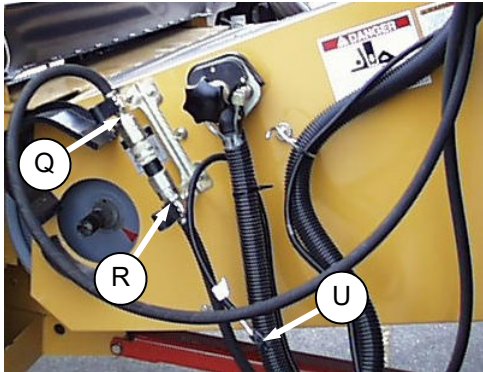

4. Disconnect hoses (Q) and (R) on combine at couplers.

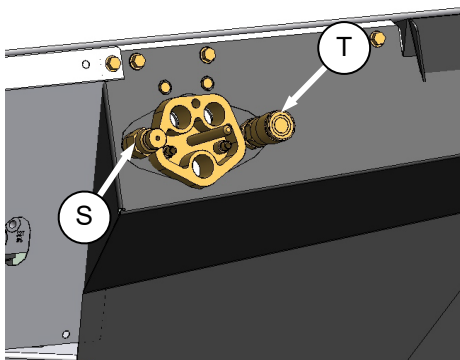

5. Connect hose (Q) to coupler (S) on adapter.
6. Connect hose (R) to coupler (T) on adapter.
7. Connect wiring harness (U) to adapter connector (not shown).

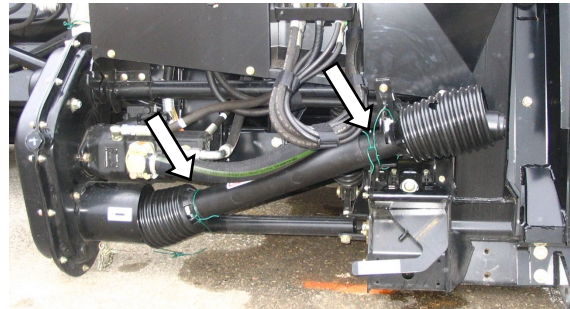

- j. Remove shipping wire securing driveline to adapter.

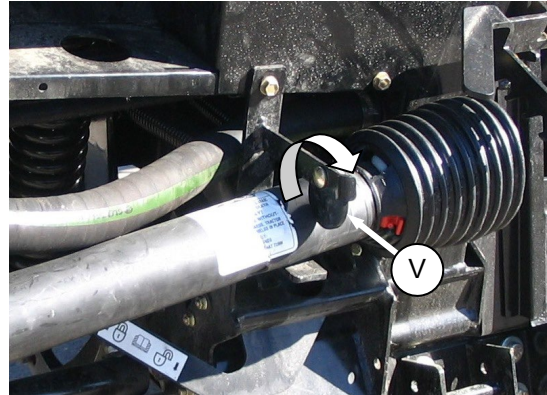

- k. Rotate disc (V) on adapter driveline storage hook and remove driveline from hook.

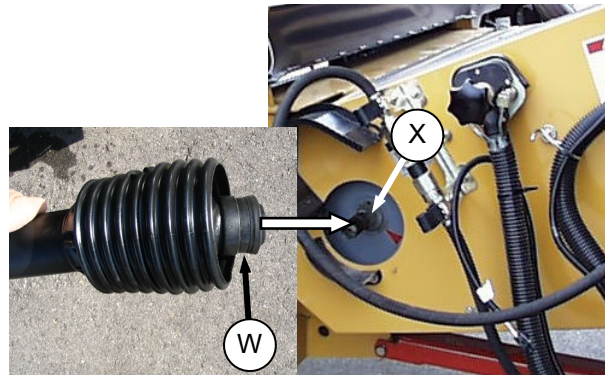

- l. Pull back collar (W) on end of drive line and push onto combine output shaft (X) until collar locks.

(continued next page)

SECTION II. ASSEMBLY – NORTH AMERICA

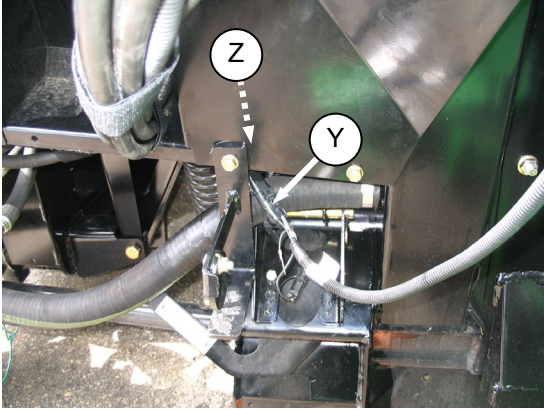

- m. If adapter is equipped with reel fore-aft/header tilt selector, connect harness (Y) to combine.

NOTE

Connector (Y) may need to be retrieved from hydraulics compartment access hole (Z).

- n. Proceed to STEP 6. REMOVE SHIPPING SUPPORTS (page 35).

SECTION II. ASSEMBLY – NORTH AMERICA

F. NEW HOLLAND

CR, CX

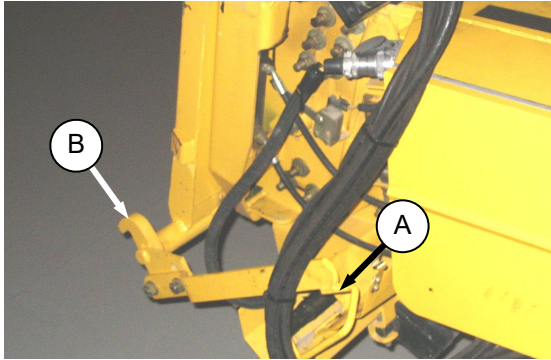

- a. Ensure handle (A) is positioned so that hooks (B) can engage adapter.

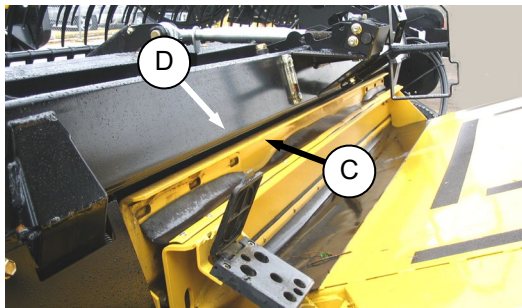

- b. Slowly drive combine up to header until feeder house saddle (C) is directly under the adapter top cross member (D).
- c. Raise feeder house to lift header, ensuring feeder saddle is properly engaged in adapter frame.



CAUTION

Stop engine and remove key from ignition before leaving operator's seat for any reason. A child or even a pet could engage an idling machine.

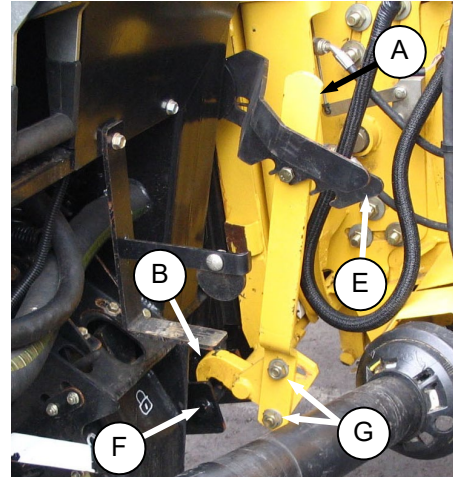

- d. Lift lever (E) on adapter at left side of feeder house and push handle (A) on combine so that hooks (B) engage pins (F) on both sides of the feeder house.
- e. Push down on lever (E) so that slot in lever engages handle to lock handle in place.
- f. If hook (B) does not fully engage pin on adapter when (A) and (E) are engaged, loosen bolts (G) and adjust lock as required. Re-tighten bolts.

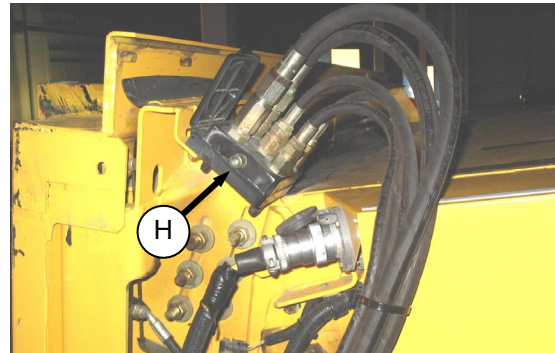

- g. Remove hydraulic quick coupler (H) from storage plate on combine.
- h. Connect to receptacle on adapter as follows:
1. Open cover (J).

(continued next page)

SECTION II. ASSEMBLY – NORTH AMERICA

- i. Connect to receptacle on adapter as follows:

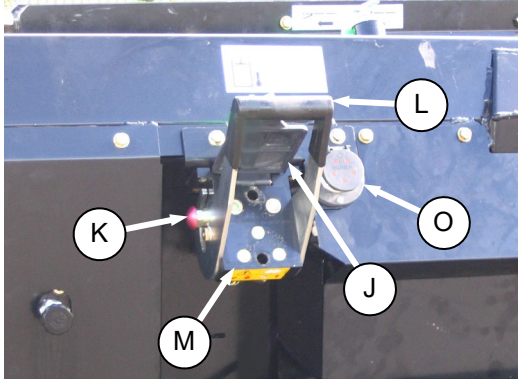

1. Open cover (J).
2. Push in lock button (K) and pull handle (L) halfway up to open position.

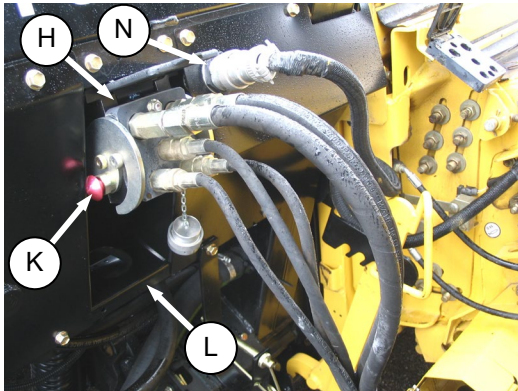

3. Remove coupler (H) from storage location on combine and clean mating surface of coupler.
4. Position coupler onto adapter receptacle (M) and push handle (L) to engage pins into receptacle.
5. Push handle (L) to closed position until lock button (K) snaps out.

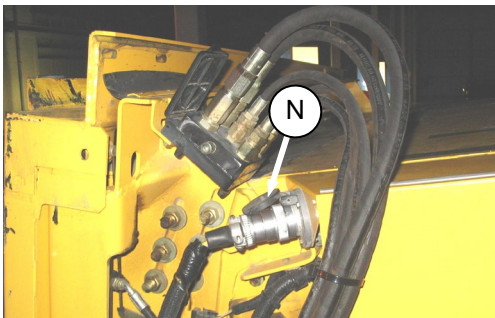

- j. Attach combine electrical connector (N) to adapter as follows:

1. Remove cover on adapter electrical receptacle (O).

2. Remove connector (N) from combine.
3. Align lugs on connector (N) with slots in adapter receptacle (O) and push connector onto receptacle. Turn collar on connector to lock it in place.

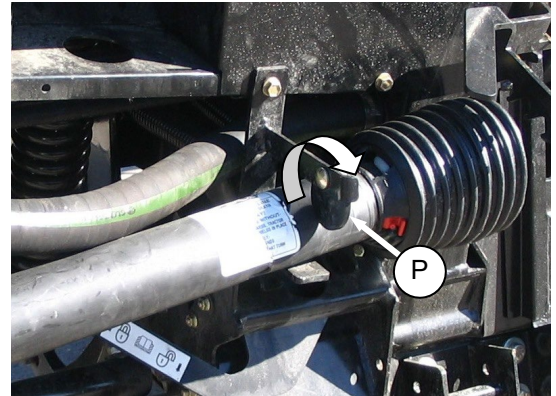

- k. Rotate disc (P) on adapter drive-line storage hook and remove drive-line from hook.

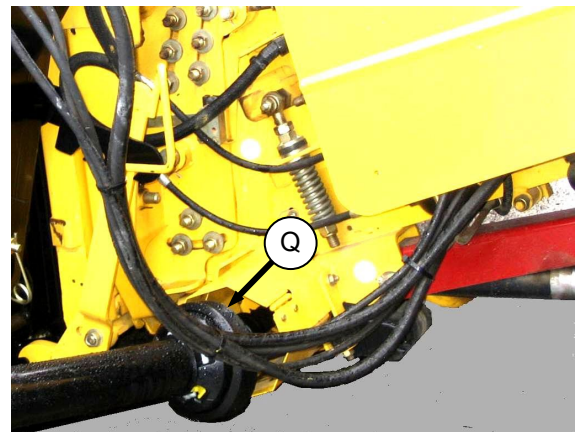

- l. Pull back collar on end of drive line and push onto combine output shaft (Q) until collar locks.

SECTION II. ASSEMBLY – NORTH AMERICA

G. AGCO

Gleaner R Series and A Series
Challenger 660, 670, and 680B
Massey 9690, 9790, and 9895

IMPORTANT

Some combine models require shorter center link components to ensure clearance to the combine cab. To avoid damage to your combine, lift feeder slowly and check clearance between cab and header center link. If clearance is inadequate, contact your dealer to order short center link components. Refer to STEP 4. SET-UP ADAPTER.

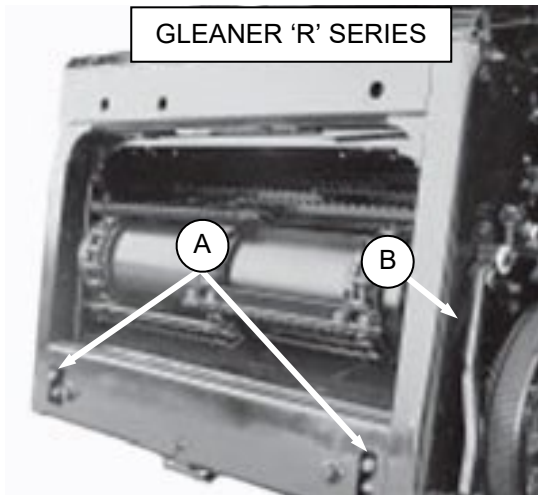

- a. Retract lugs (A) at base of feeder-house with lock handle (B).

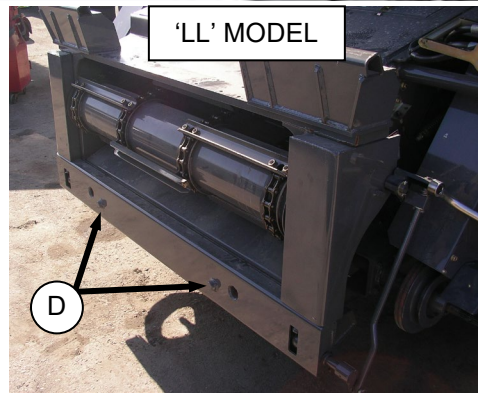
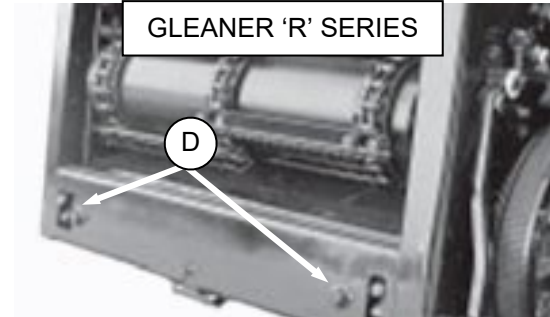
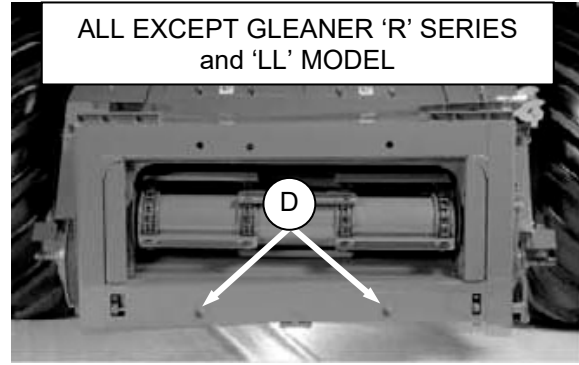

- b. Slowly drive combine up to header until feeder house is directly under the adapter top cross member (C) and alignment pins (D) are aligned with holes (E) in adapter frame.

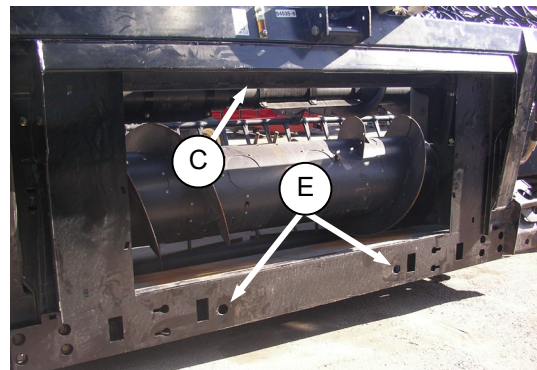

(continued next page)

SECTION II. ASSEMBLY – NORTH AMERICA

AGCO (Cont'd)

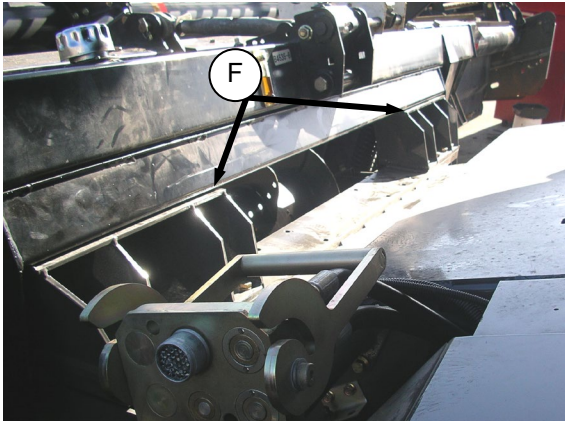

- c. Raise feeder house to lift header, ensuring feeder house saddle (F) and alignment pins are properly engaged in adapter frame.
- d. Position header slightly off the ground.



CAUTION

Stop engine and remove key from ignition before leaving operator's seat for any reason. A child or even a pet could engage an idling machine.

ALL EXCEPT GLEANER 'R' SERIES

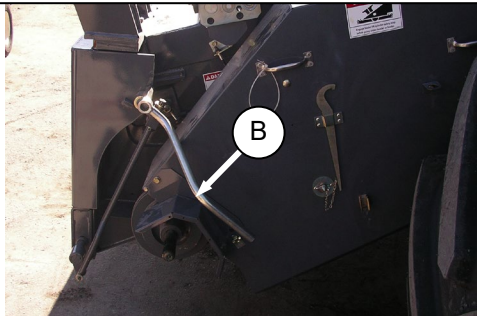

GLEANER 'R' SERIES

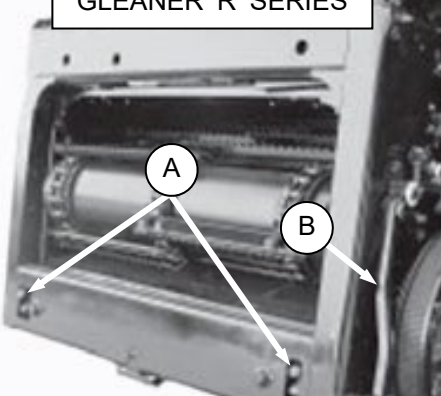

- e. Engage lugs (A) with adapter using lock handle (B).

- f. Remove blocks from under cutterbar.
- g. Start engine and lower header. Shut down the combine.

NOTE

The CA20 Combine Adapter is equipped with a multi-coupler that connects to the combine. If your combine is equipped with individual connectors, a multi-coupler kit (single-point connector) must be installed. The kits are available through your AGCO dealer and include installation instructions.

COMBINE	AGCO KIT #
Challenger	71530662
Massey	71411594
Gleaner 'R' Series	71414706

- h. Connect adapter hydraulic quick coupler to combine receptacle as follows:

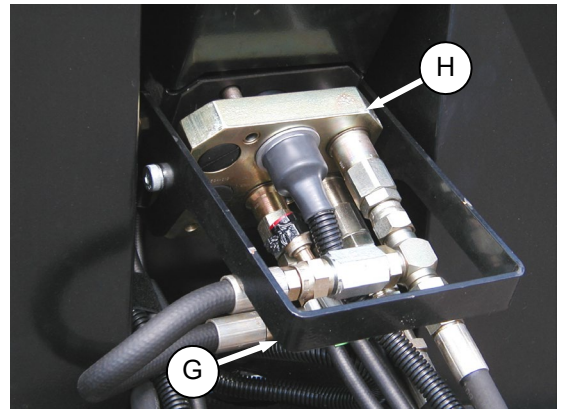

- 1. Pull handle (G) to release coupler (H) from adapter.

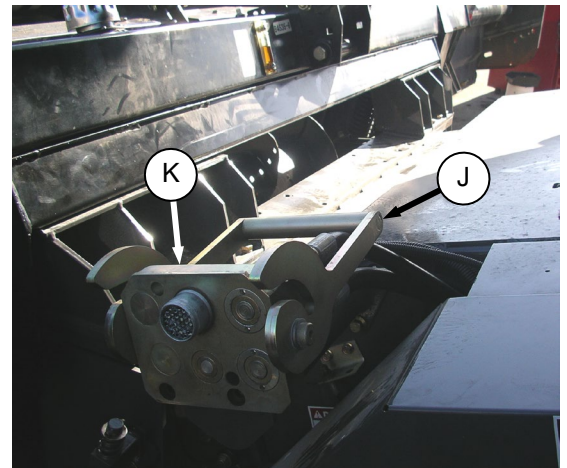

- 2. Push handle on combine (J) to full open position. Clean receptacle (K).

(continued next page)

SECTION II. ASSEMBLY – NORTH AMERICA

AGCO (Cont'd)

3. Position coupler (H) onto combine receptacle (K) and pull handle to fully engage coupler into receptacle.

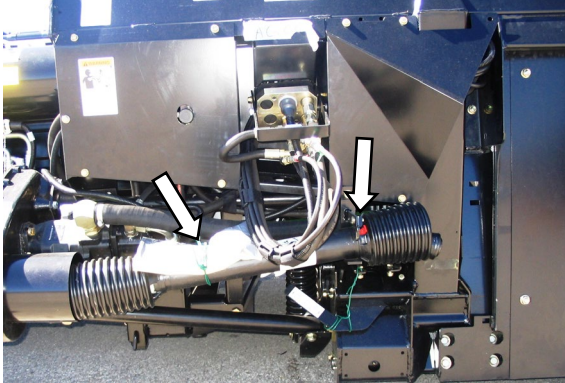

- i. Remove shipping wire securing driveline to adapter.

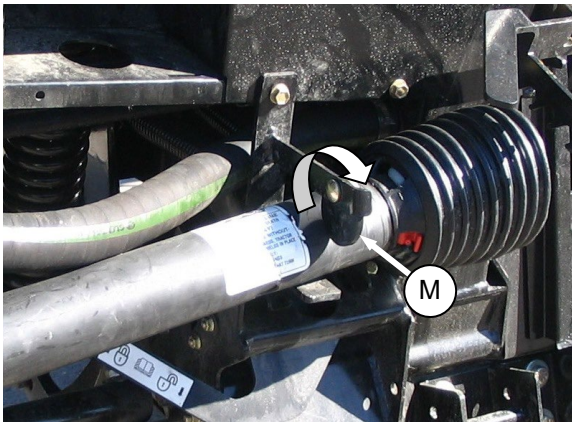

- j. Rotate disc (M) on adapter driveline storage hook and remove driveline from hook.

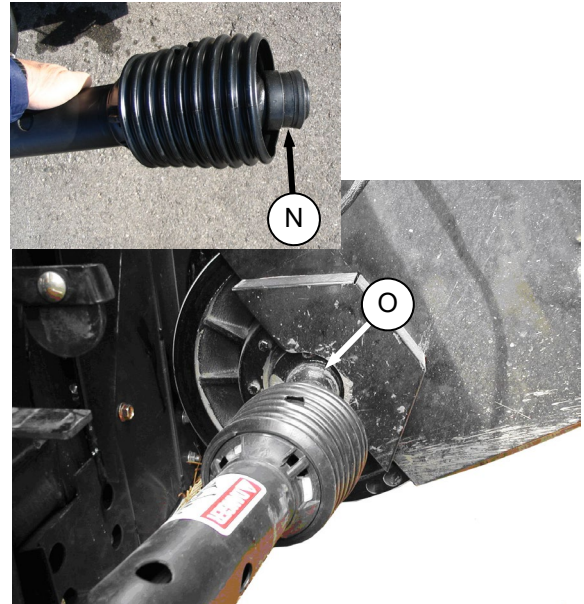

- k. Pull back collar (N) on end of drive line and push onto combine output shaft (O) until collar locks.

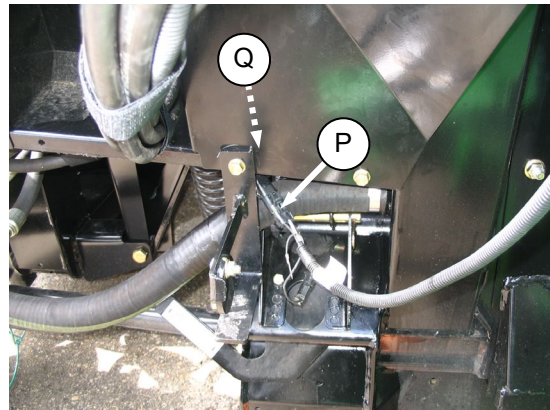

- l. Connect harness (P) to combine.

NOTE

Connector (P) may need to be retrieved from hydraulics compartment access hole (Q).

- m. Proceed to STEP 6. REMOVE SHIPPING SUPPORTS (page 41).
- n. For Export configuration, proceed to **SECTION III, STEP 10. CONNECT FORE-AFT CYLINDERS.**

SECTION II. ASSEMBLY – NORTH AMERICA

STEP 6. REMOVE SHIPPING SUPPORTS

The removable supports are painted yellow. Refer to illustrations and remove supports as follows:

NOTE

Unless otherwise specified, discard supports, and all shipping material and hardware.

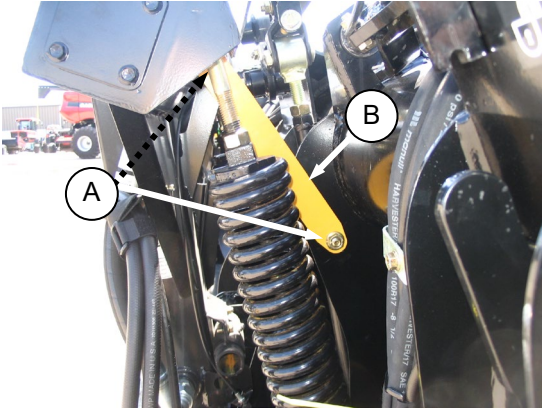

- Remove two bolts (A) and remove strap (B) from both sides of center frame.

NOTE

If strap is difficult to remove, lift on one end of header to release the load on the strap so that bolts can be removed.

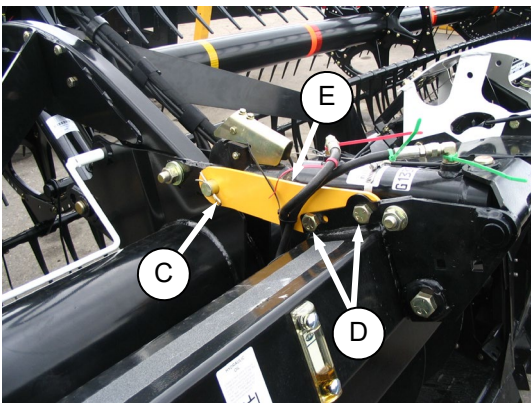

- Remove cotter pin (C), bolts (D), and remove shipping brace (E).
- Re-install cotter pin (C).

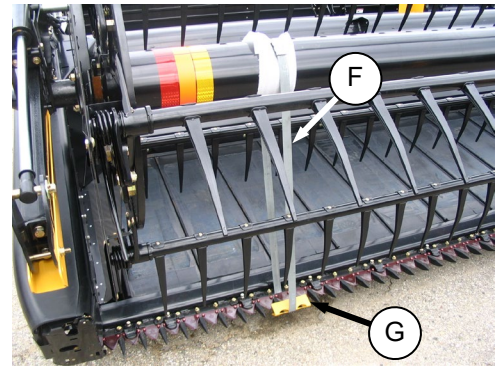

- Cut banding (F) securing reel to cutterbar and remove angle (G) on cutterbar and packing material from reel tube at three locations.



CAUTION

Reel arms must be level prior to removing reel shipping braces. Failure to do so may result in reel moving suddenly.

- Start combine and level the reel arms with the combine hydraulics.

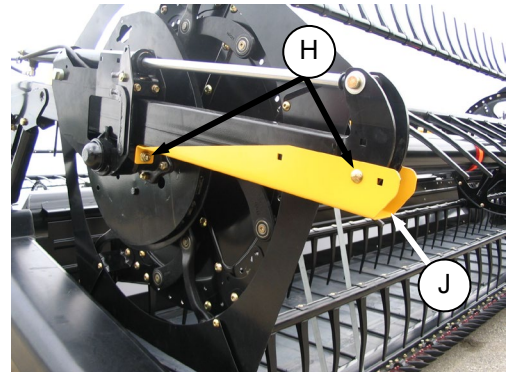

- Remove two bolts (H) attaching fore-aft brace (J) to reel arm and remove brace. Repeat for opposite arm and center arm.

STEP 7. POSITION TRANSPORT LIGHTS



Position light perpendicular to header. Lights are located on each of the outboard reel arms.

SECTION II. ASSEMBLY – NORTH AMERICA

STEP 8. INSTALL CROP DIVIDERS

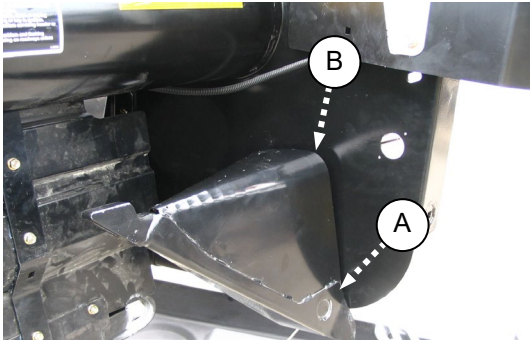

- a. At divider storage location, lift divider to disengage lugs (A) at lower end and then lower it slightly to disengage pin (B) from end sheet.

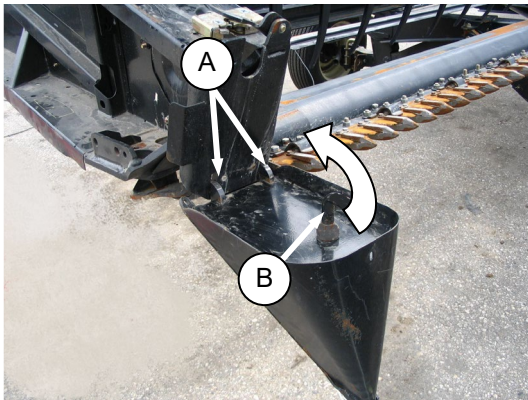

- b. Position crop divider as shown by locating lugs (A) in holes in end sheet.
c. Lift forward end of divider until pin (B) at top of divider engages and closes latch (C).

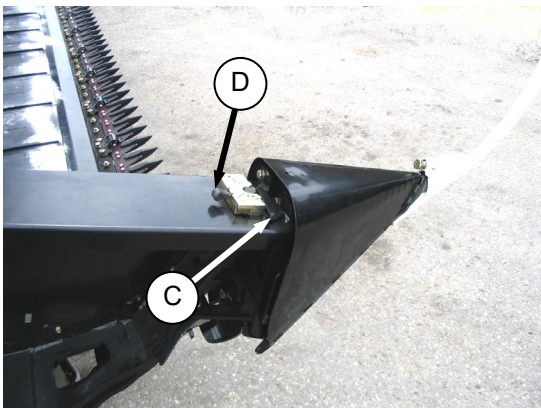

- d. Push safety lever (D) down to lock pin in latch.

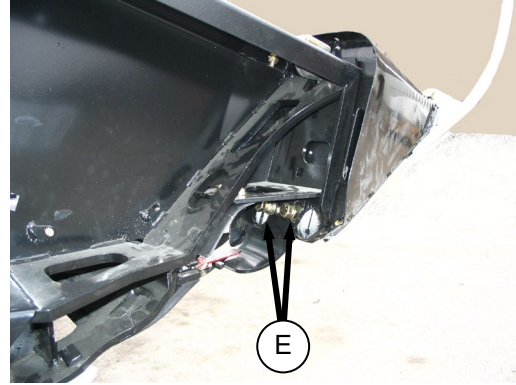

- e. Check that divider does not move laterally. Adjust bolts (E) as required to tighten divider and remove lateral play when pulling at divider tip.

STEP 9. PRE-DELIVERY CHECKS

Refer to **SECTION IV. PRE-DELIVERY CHECKS.**

SECTION III. ASSEMBLY - EXPORT

- c. Remove the two braces securing adapter to header, and discard.

SECTION III. ASSEMBLY – EXPORT

NOTE

Some procedures in this section refer to steps in **SECTION II. ASSEMBLY – NORTH AMERICA.**

STEP 1. INSTALL CENTER LINK

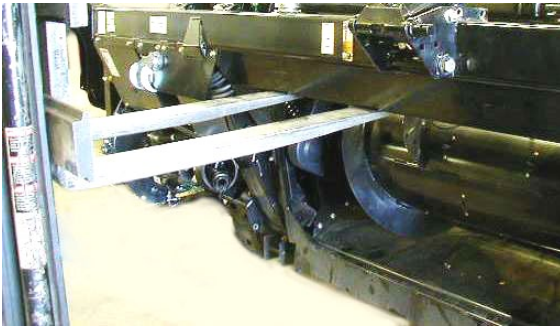

- a. Support the adapter with a forklift or crane.

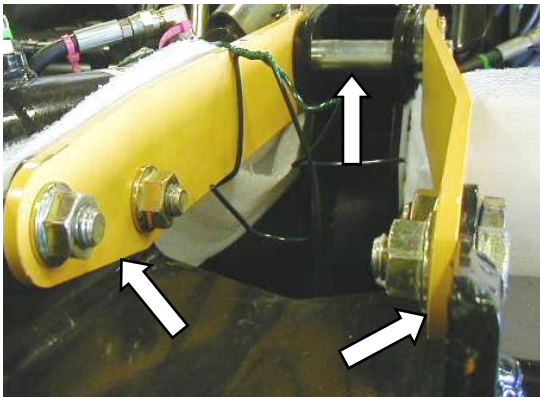

- b. Remove four bolts and pin, and remove the two shipping brackets between the adapter and header at the center link location. Re-install pin and secure with cotter pins. Discard the shipping brackets.

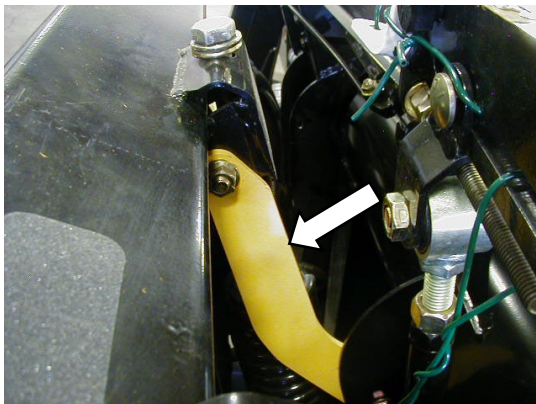

SECTION III. ASSEMBLY - EXPORT

IMPORTANT

Some combine models require shorter center link components to ensure clearance to the combine cab. The following combine models have been identified for requiring the shorter center link components: See **SECTION II STEP 4 SET-UP ADAPTER** for additional information.

- Case IH 5088, 6088, and 7088 Without Stone Traps.
 - Gleaner R Series.
- d. If necessary, obtain the shorter center link assembly kit and install in accordance with the instructions provided with the kit. Otherwise, proceed with the next step.
- e. Remove the center link clevis assembly and cylinder from shipping position on the center reel arm.

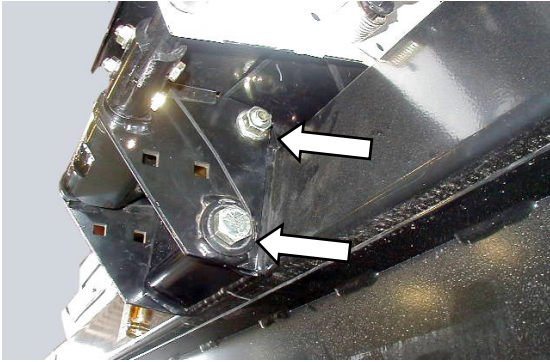

- f. Install the bracket assembly for the top link with one $\frac{3}{4}$ in.-8.5 long hex bolt, two $\frac{5}{8}$ in.-1.5 lg. carriage bolts, and nuts provided with the assembly..

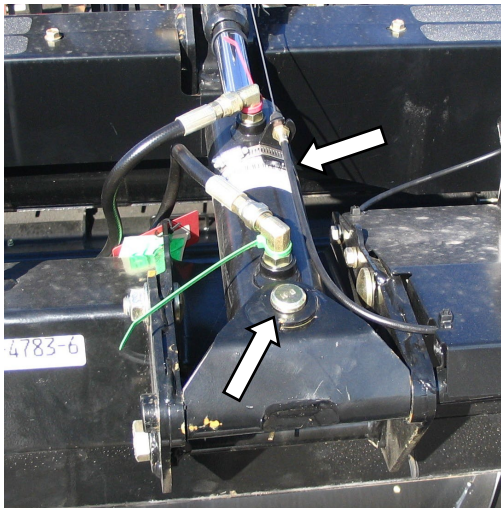

- g. Install center link with pin at adapter.

(continued next page)

SECTION III. ASSEMBLY - EXPORT

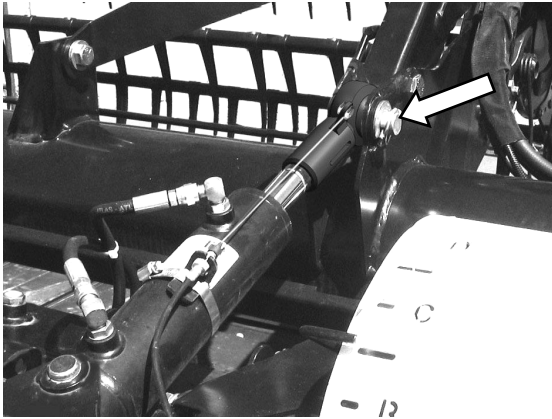

- h. For **eye type** centerlink, remove pin in header bracket.. Loosen hydraulic fittings on cylinder and extend or retract cylinder so pin can be re-installed through eye and header bracket. Re-tighten fittings.

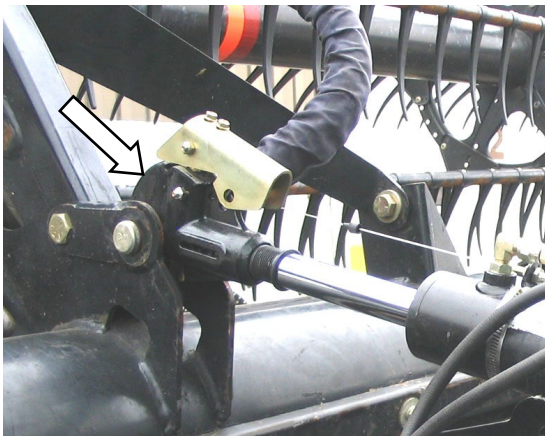

- i. For optional **hook type** centerlink, loosen hydraulic fittings on cylinder and extend or retract cylinder so that hook engages header bracket. Re-tighten fittings.
- j. Remove the float indicator assembly from the shipping position on the center reel arm brace. Ensure cables are not kinked or damaged.

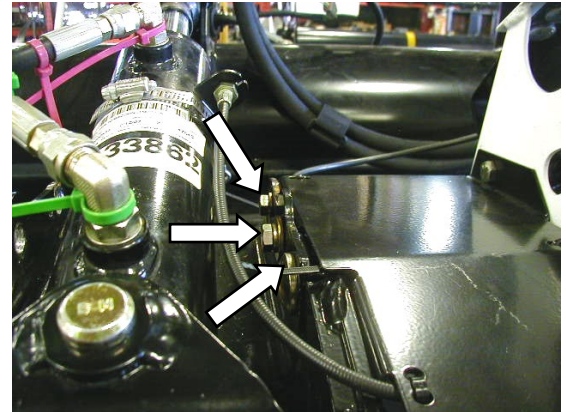
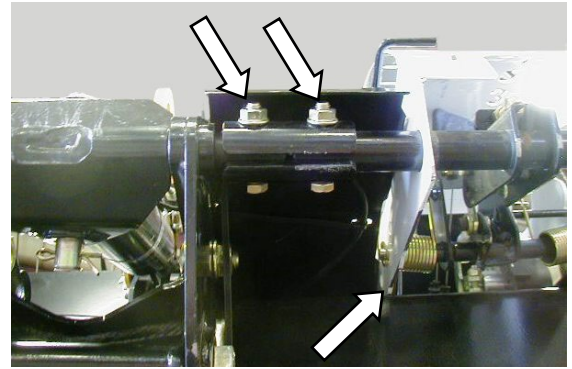

- k. Attach the float indicator assembly with two 3/8 in.x2.0 hex bolts and nuts, and two 3/8 in.-0.75 lg. hex bolts, lock washers, and flat washers provided with the assembly.

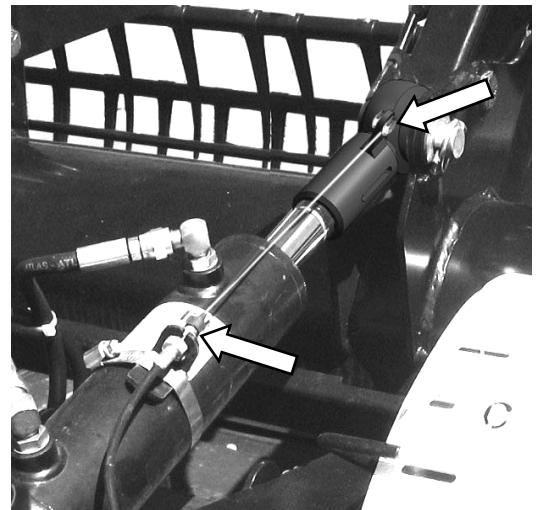

- l. Attach cable to cylinder at barrel and at eye.
(continued next page)

SECTION III. ASSEMBLY - EXPORT

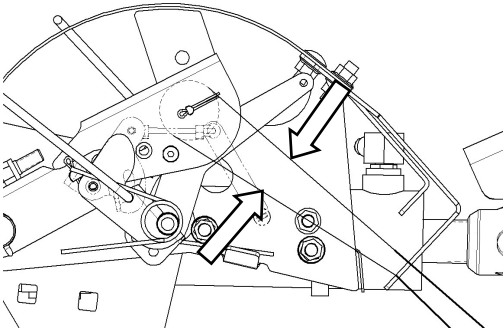
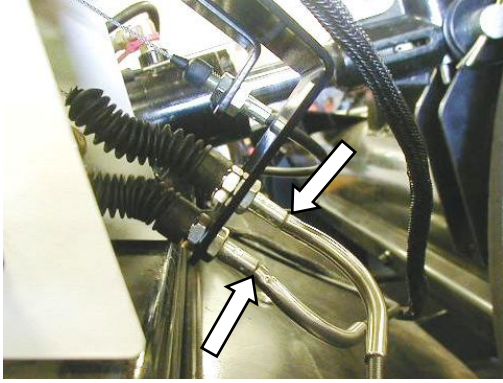

- m. Attach cables for auto header height onto bracket. Ensure cables are on pulley and are not crossed.

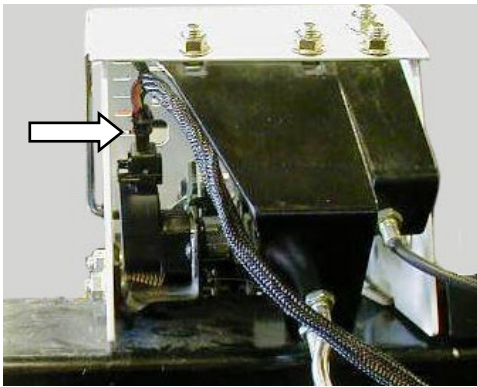

- n. Plug in the wiring harness for the Auto Header Height Control.

SECTION III. ASSEMBLY - EXPORT

STEP 2. INSTALL FLOAT LINKS

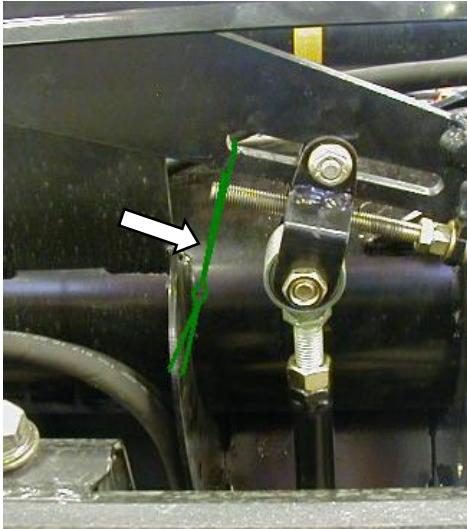

a. Remove the shipping wire from bellcrank.



b. Remove pre-installed bolt, washers, and nut from bell crank. Discard washers (used to retain bushing for shipping).

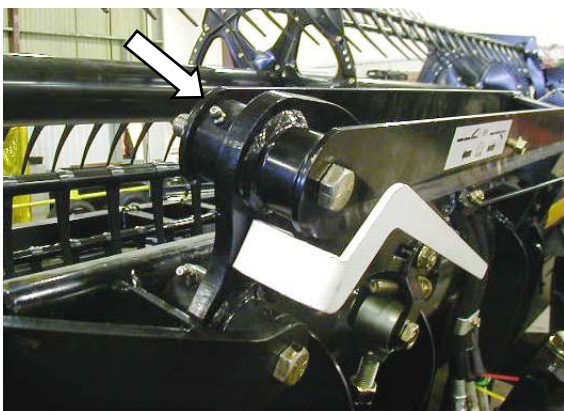

c. Remove shipping wire from top link and install top link to bell crank support with hex bolt and nut provided. Torque to 200 ft·lbf (N·m).

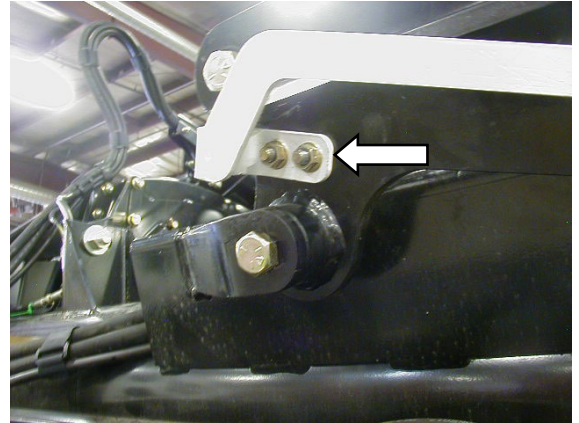

d. Install white indicator to bell crank support with hardware pre-installed in bell crank.

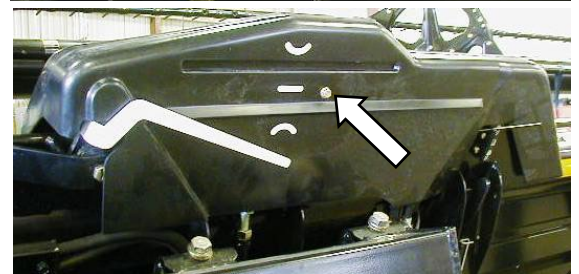
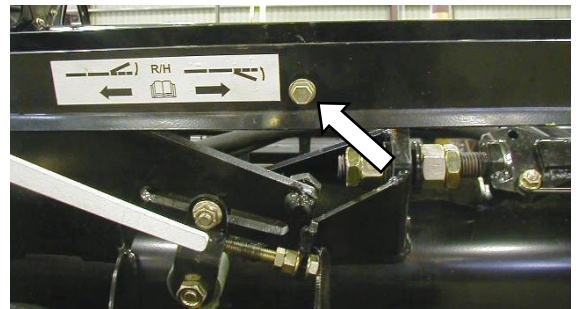

e. Remove bolt from top link, install float linkage cover and re-install bolt to secure cover.

f. Repeat above steps a. to e. for opposite side.

SECTION III. ASSEMBLY - EXPORT

STEP 3. INSTALL REEL SPEED SENSOR

NOTE

This step is not applicable to CASE/CNH combines. Proceed to STEP 4.

IMPORTANT

Except for Lexion combines, sensors are not supplied with MacDon Combine Adapters having Serial Numbers earlier than 177626_07. Sensors need to be purchased as per the following:

COMBINE	SENSOR PART NO,
JOHN DEERE-ALL	John Deere #AH116104 & Two Nuts #H104418.
AGCO-ALL	AGCO #71 391 021

Refer to **SECTION II. STEP 2 INSTALL REEL SPEED SENSOR.**

STEP 4. INSTALL OPTIONS

Retrieve kits supplied as options with the header and install in accordance with installation instructions supplied in each kit.

SECTION III. ASSEMBLY - EXPORT

STEP 5. ATTACH REEL LIFT CYLINDERS

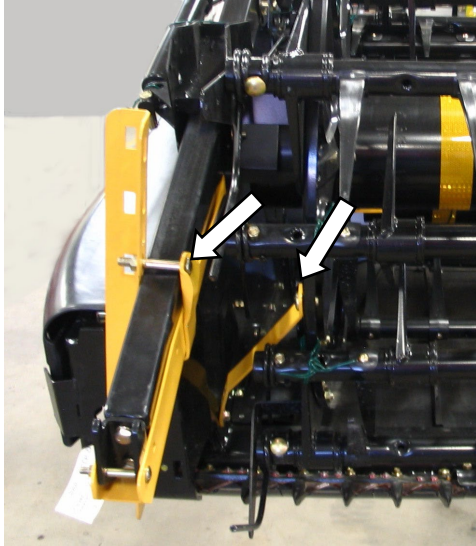

- a. Remove top bolt on outboard reel arm supports.

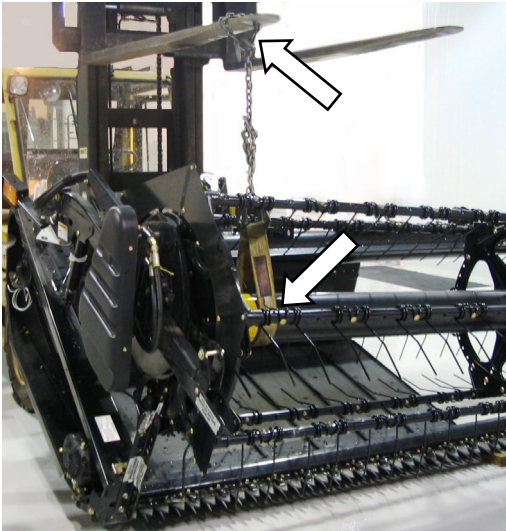

- b. Position sling around the reel tube close to outboard end of reel and attach sling to a forklift (or equivalent).
c. Lift reel so that reel lift cylinder can be installed.

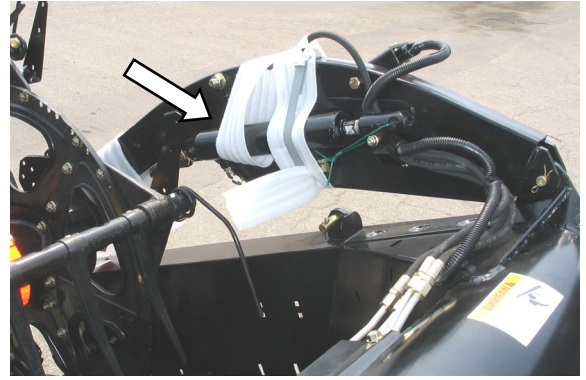

- d. Remove shipping wire/banding from cylinder.

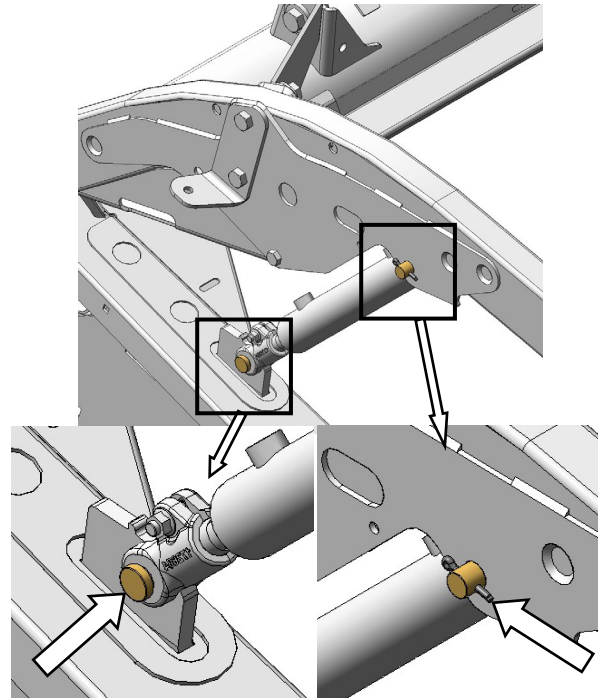

- e. Remove pins from reel arm. Secure cylinder to end sheet and reel arm with pins as shown. Secure with cotter pins.

(continued next page)

SECTION III. ASSEMBLY - EXPORT



- f. Remove sling and reposition around reel tube near reel center support arm.
- g. Lift reel slightly to take weight off reel center arm support.

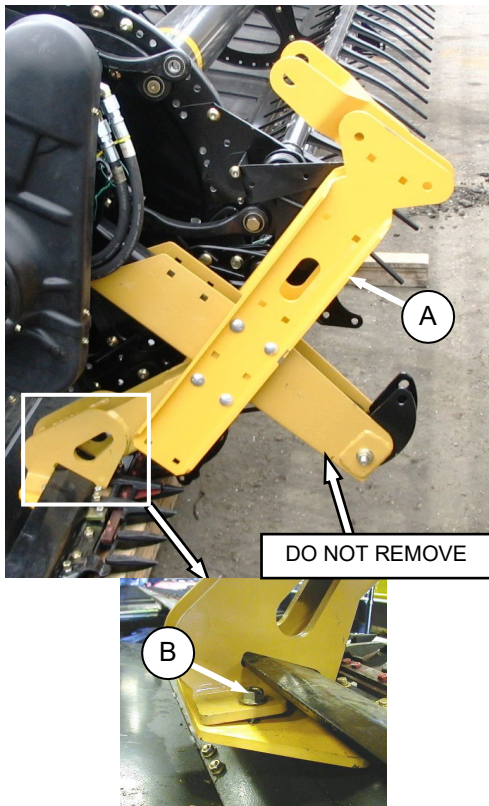

- h. Remove the two support channels (A) at the reel center arm. Do not remove support on reel arm.
- i. Remove bolt (B) at top of lower support and slide lower support off cutterbar.

- j. Lift reel so that reel center lift cylinder mounting holes line up with bracket on frame.



- k. Remove shipping wire/banding from cylinder and remove pin from frame. Secure cylinder to frame with pin as shown. Secure with cotter pin.

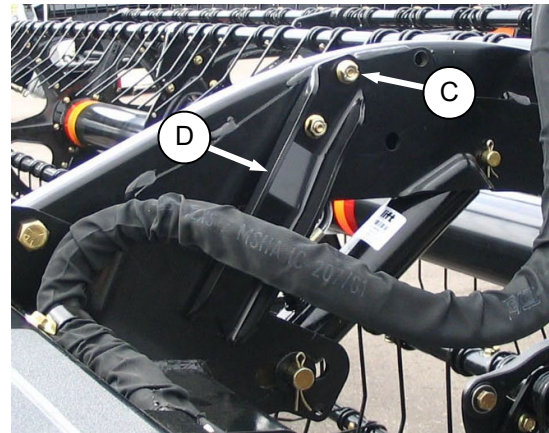

- l. At center reel arm, remove bolt (C), lower the reel prop (D), and reinstall bolt through same hole in arm, reel prop and hose clamp.
- m. Remove sling and reposition around reel tube near opposite outboard reel arm.
- n. Lift reel so that reel lift cylinder can be installed.
- o. Remove shipping wire/banding from cylinder.
- p. Remove pins from reel arm.

(continued next page)

SECTION III. ASSEMBLY - EXPORT

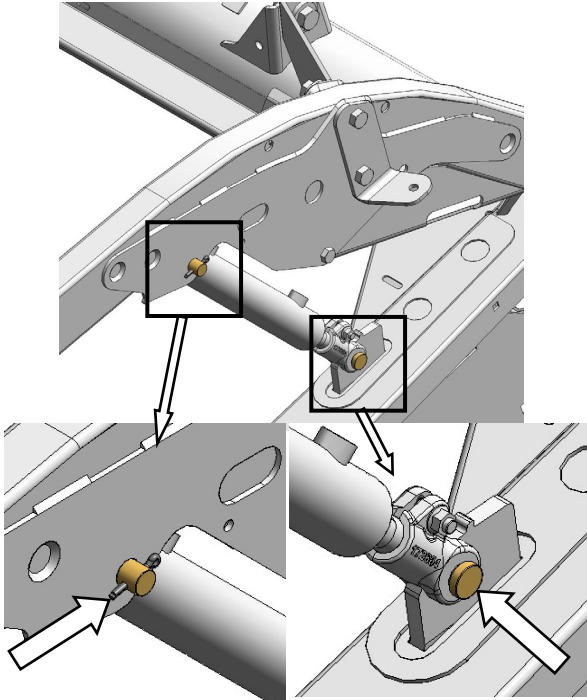

- q. Secure cylinder to end sheet and reel arm with pins as shown. Secure with cotter pins.

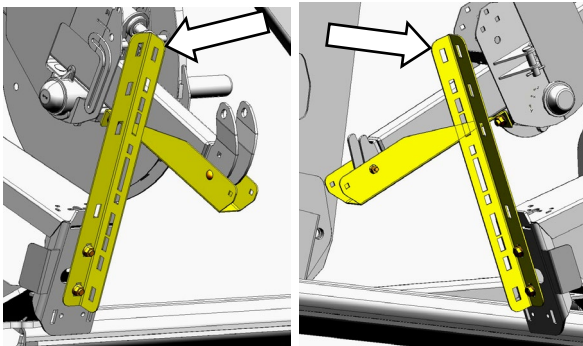

- r. Remove the two reel arm supports from end sheets. **DO NOT REMOVE BRACES ON REEL ARMS.**

SECTION III. ASSEMBLY - EXPORT

STEP 6. ATTACH CAM ARMS

NOTE

The upper tine bar may have been collapsed at the factory for shipping purposes.

- a. If necessary, re-attach supports to reel discs for the upper tine bar as follows:

1. Remove shipping wire from supports.

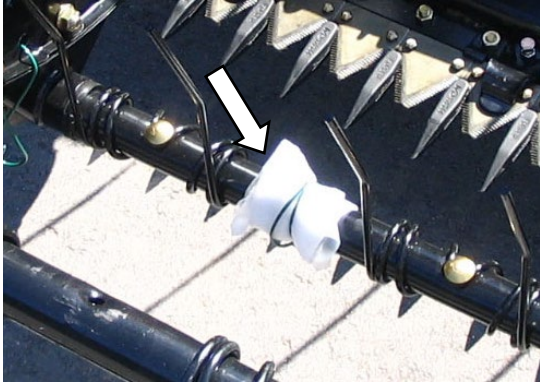

2. Retrieve bag of hardware from tine bar.
3. Reposition tine bar to align support attachment holes with disc.
4. Secure supports to discs as shown with bolts and nuts provided in bag.

INSTALL CENTER BOLT LATER
WITH END SHIELD SUPPORT

1/2 in.x0.75 TORX

1/2 in.x1.0 TORX

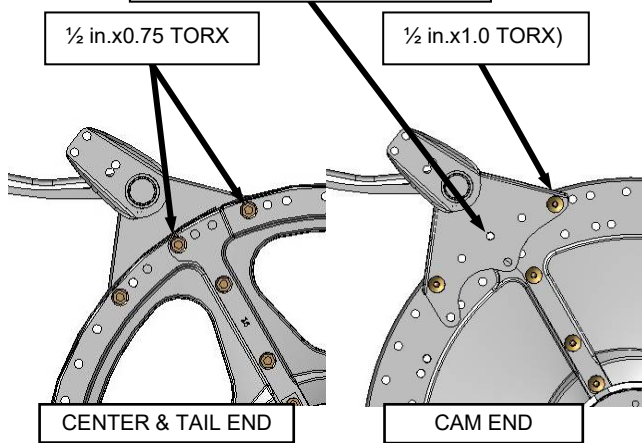

5. Torque bolts to 70-80 ft-lbf (95-108 N·m).
- b. Manually rotate reel until the tine bars with the disconnected cam links are accessible.

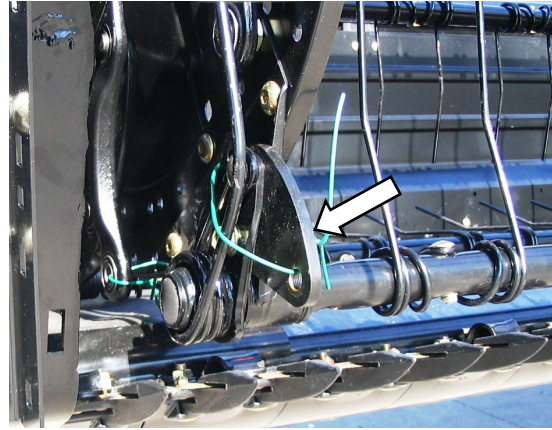

- c. Remove shipping wire if not already removed.
- d. Rotate tine bar crank (A), and position link (B) until attachment holes in bar crank and link are approximately aligned.

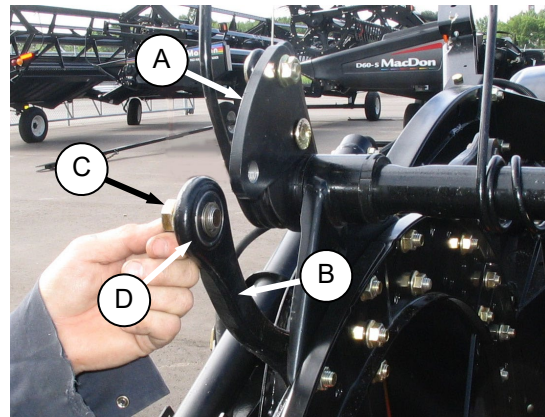

- e. Install bolt (C) in link and position shim (D) on bolt so that shim is between link (B) and tine bar crank (A).

NOTE

Bolts are pre-coated with Loctite so no further locking method is required.

- f. Realign link and tine bar crank and thread in the bolt (C).
- g. Repeat for remaining tine bars and torque bolts to 120 ft-lbf (165 N·m).

SECTION III. ASSEMBLY - EXPORT

STEP 7. INSTALL REEL END SHIELDS

Endshields on each end of some reels were removed for shipping purposes. If necessary, re-install shields as follows:

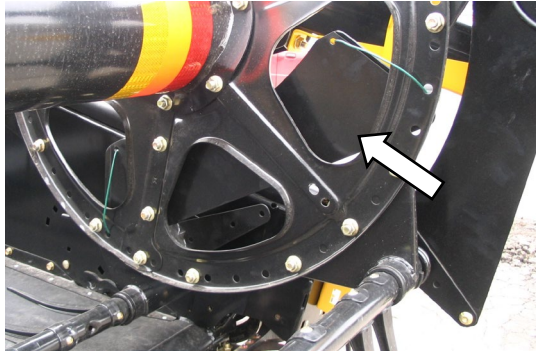

- Manually rotate reel until the wired endshields are accessible. Remove endshields.
- Manually rotate reel for accessibility to re-install the shields.

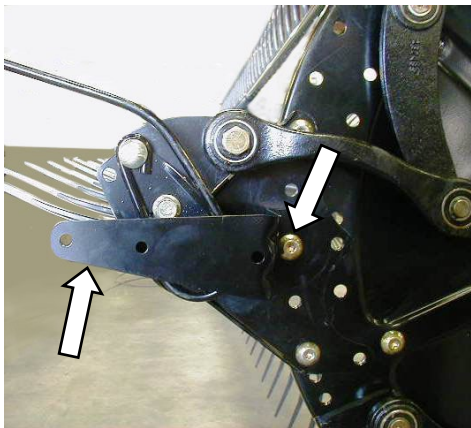

- If supports are installed, loosen bolts securing endshield supports to disc and rotate supports approximately as shown.

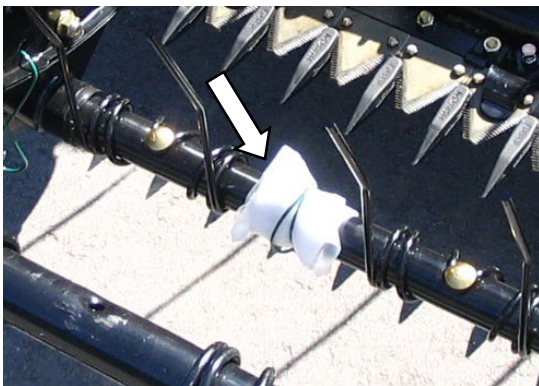

- Retrieve hardware from bag removed in STEP 8.

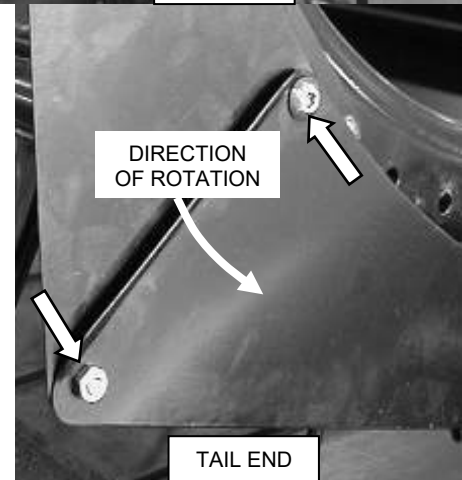
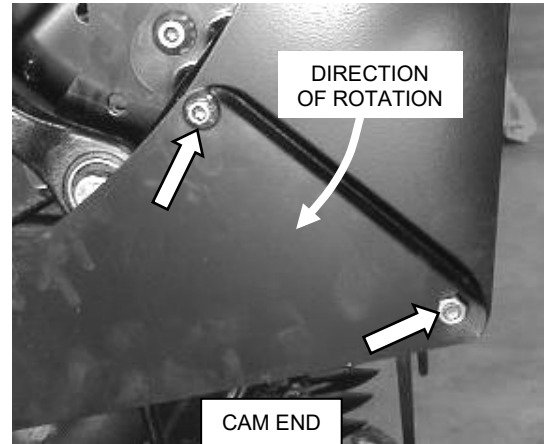

- Install endshields with lip in relation to reel rotation. Use 3/8 in.-0.5 lg. torx head screws and torque to 20 ft·lbf (27 N·m). **See photos for hardware orientation.** The jam nuts must be locking jam nuts. If they aren't locking nuts, use Loctite.
- Re-tighten endshield support bolts.

SECTION III. ASSEMBLY - EXPORT

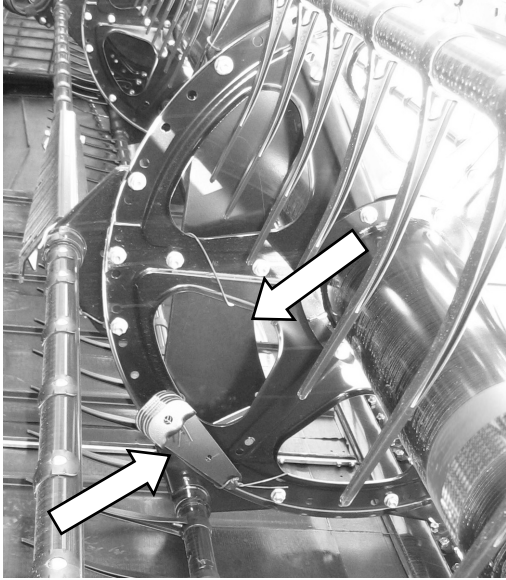

- g. If supports are not installed, retrieve supports and endshields that are wired to the reel disc.

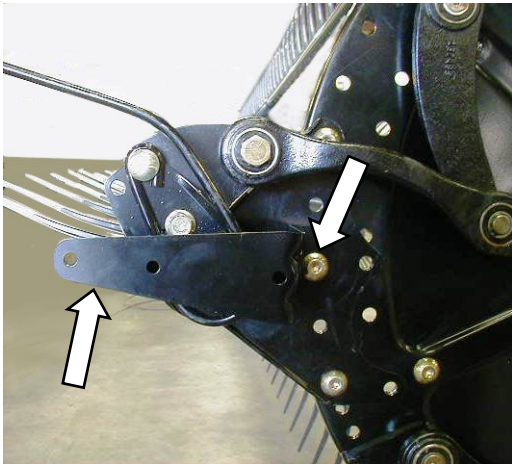

- h. Install endshield supports on disc as shown at each tine bar location, with hardware provided in bag.
- i. Install endshields. See step e. on previous page.

SECTION III. ASSEMBLY - EXPORT

STEP 8. INSTALL CENTER FORE/AFT CYLINDER

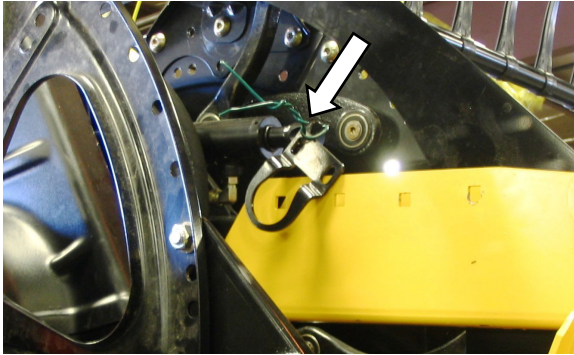

- a. At reel center arm, if fore/aft cylinder is secured with shipping wire, proceed as follows, otherwise proceed to STEP 11.
1. Remove shipping wire and clip from cylinder rod end.

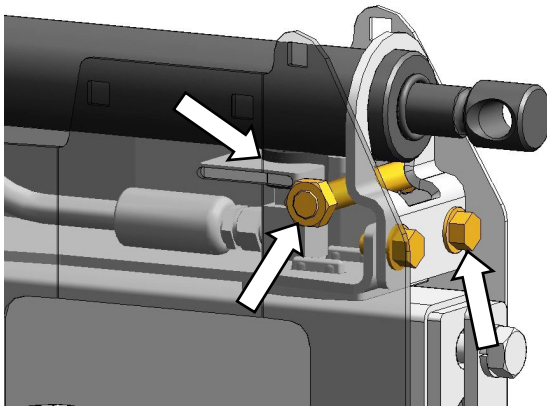

2. Remove the two 3/8 in.-0.62 lg. hex screws and one 1/2 in.-3.5 lg. hex bolt and nut.
3. Position cylinder so that cylinder port locates in hole in cylinder cradle. Reinstall 1/2 in.-3.5 lg. hex bolt and nut.
4. Position clip on cylinder as shown and install with the two 1/2 in.-3.5 hex bolts and nuts. Tighten hardware.

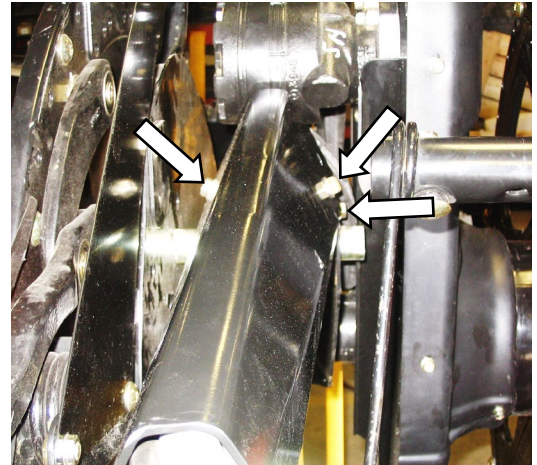

- b. Install cover over center hoses of reel fore/aft cylinder with three 3/8 in.-0.62 lg. hex screws provided.

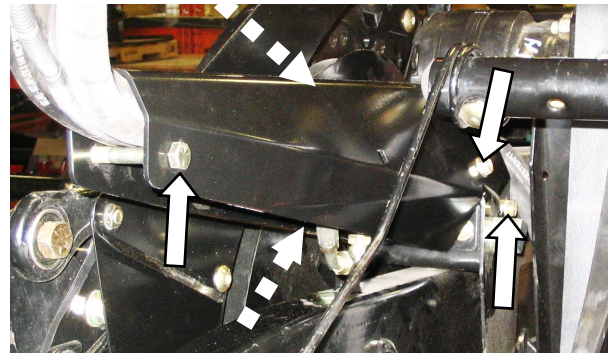

- c. Locate hoses in cover and install one 3/8 in.-2.75 lg. bolt and nut provided.

IMPORTANT

Leave sufficient hose behind the cover to allow reel to move fully forward.

STEP 9. SET-UP ADAPTER

Refer to **SECTION II. STEP 4 SET-UP ADAPTER.**

STEP 10. ATTACH TO COMBINE

Refer to **SECTION II. STEP 5 ATTACH TO COMBINE.**

SECTION III. ASSEMBLY - EXPORT

STEP 11. CONNECT FORE-AFT CYLINDERS



CAUTION

The reel fore-aft hydraulic cylinders must be connected to the reel prior to removing the fore-aft supports. Failure to do so may result in the reel sliding full forward when the supports are removed.



CAUTION

Reel arms must be level prior to removing reel shipping braces. Failure to do so may result in reel moving suddenly.



CAUTION

Be sure all bystanders are clear of machine before starting engine or engaging any header drives.

- Remove shipping wire and pins from fore/aft cylinders. Pin may be installed in arm. One cylinder on each reel support arm.
- Start combine and level the reel arms with the combine hydraulics.
- Extend and retract fore/aft cylinders to rephase cylinders.
- Align cylinders with reel arm mounting holes with combine hydraulics. Stop engine and remove key.
- Attach fore/aft cylinders to reel arms with clevis pins, washers, and cotter pins as shown.

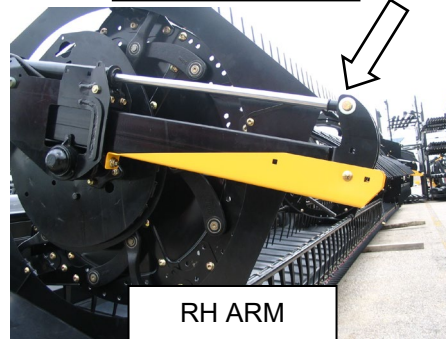
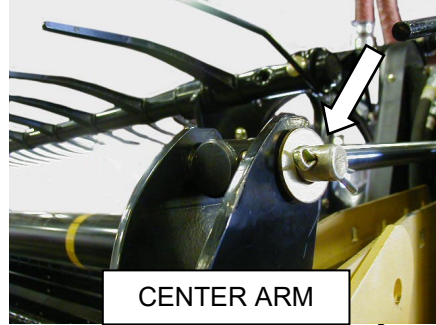
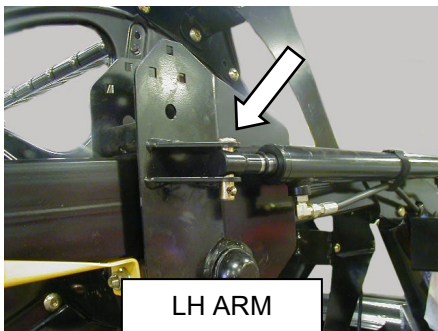

- Remove supports on reel arms.

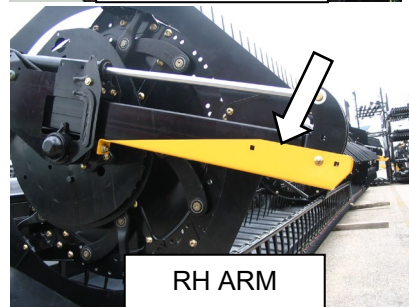
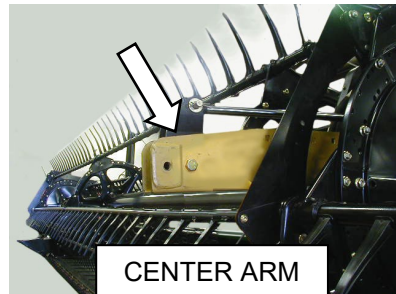
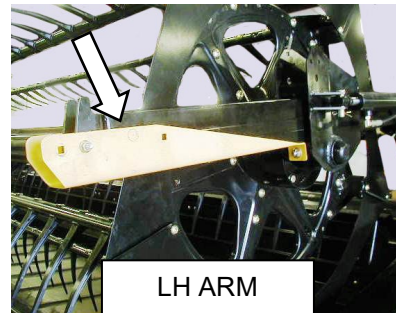

SECTION III. ASSEMBLY - EXPORT

STEP 12. INSTALL CROP DIVIDERS

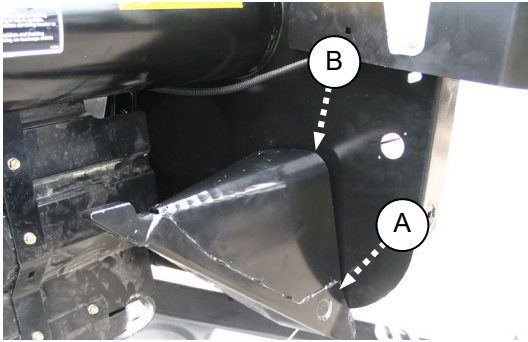

- a. At divider storage location, lift divider to disengage lugs (A) at lower end and then lower it slightly to disengage pin (B) from end sheet.

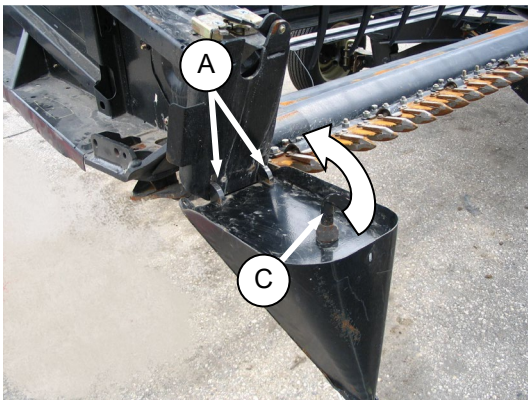

- b. Position crop divider as shown by locating lugs (A) in holes in end sheet.
c. Lift forward end of divider until pin (C) at top of divider engages and closes latch (D).

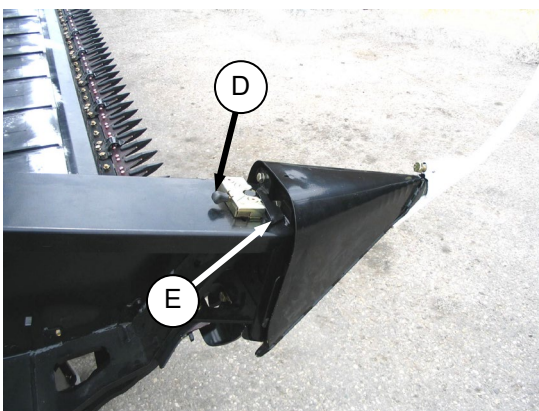

- d. Push safety lever (E) down to lock pin in latch.

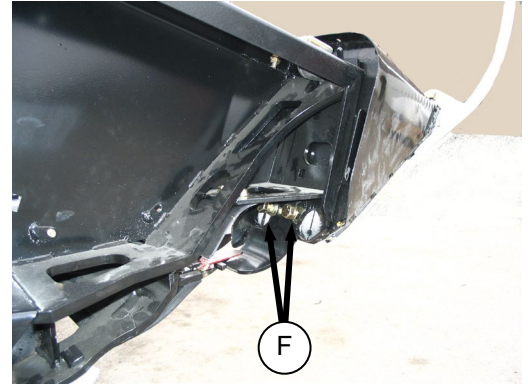

- e. Check that divider does not move laterally. Adjust bolts (F) as required to tighten divider and remove lateral play when pulling at divider tip.



- f. Remove divider rods from storage location on header endsheet.

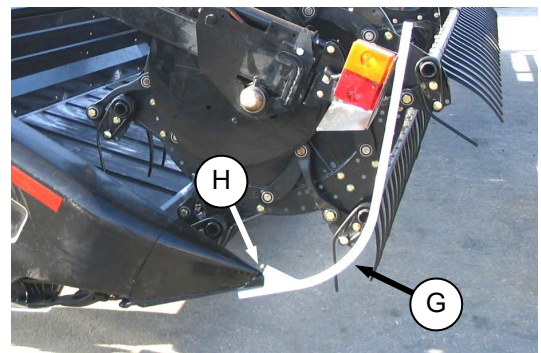

- g. Position divider rod (G) on tip of crop divider as shown and tighten bolt (H).

SECTION III. ASSEMBLY - EXPORT

STEP 13. POSITION TRANSPORT LIGHTS



Position light perpendicular to header. Lights are located on each of the outboard reel arms.

STEP 14. PRE-DELIVERY CHECKS

Refer to **SECTION IV. PRE-DELIVERY CHECKS.**

SECTION IV. PRE-DELIVERY CHECKS

SECTION IV. PRE-DELIVERY CHECKS



WARNING

Stop combine engine and remove key before making adjustments to machine. A child or even a pet could engage the drive.

IMPORTANT

To avoid machine damage, check that no shipping dunnage has fallen into machine.

- a. Perform the final checks as listed on the "Pre-Delivery Checklist" (yellow sheet attached to this instruction) to ensure the machine is field-ready. Refer to the following pages for detailed instructions as indicated on the checklist.

IMPORTANT

The machine has been set at the factory and should require no further adjustments. However, perform the following checks to ensure your machine will provide maximum performance. Adjustments should be made only if absolutely necessary and in accordance with the instructions in this manual.

- b. The completed checklist should be retained either by the operator or the dealer.

A. TIRE PRESSURE - SLOW SPEED TRANSPORT & STABILIZER WHEEL OPTIONS

Check tire inflation pressure. If necessary, inflate as per following table.

YR	TIRE	SIZE	PRESSURE
2006 & EARLIER	GOODYEAR WRANGLER RT/S	205-75 R15	40 psi (276 kPa)
2007 to 2009	CARLISLE & TITAN	ST205/75 R15	65 psi (448 kPa)
2010 & LATER	DICO	ST205/75 R15	LR "D" 65 psi (448 kPa)
			LR "E" 80 psi (552 kPa)

IMPORTANT

Do not exceed maximum pressure specified on tire side wall.

B. WHEEL BOLT TORQUE - SLOW SPEED TRANSPORT & STABILIZER WHEEL OPTIONS

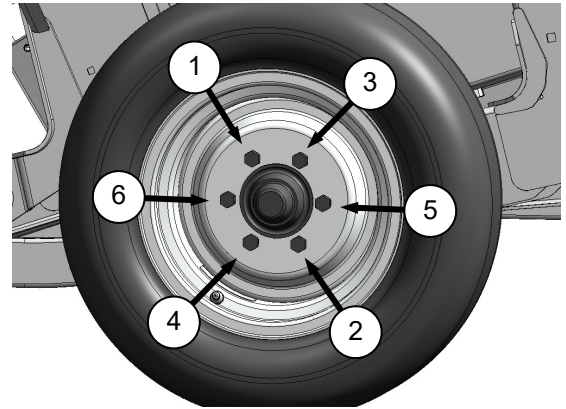

Check wheel bolt torque is 80-90 ft-lbf (110-120 N·m). Refer to bolt tightening sequence illustration.

C. WOBBLE BOX

For access to the wobble box(es), the endshield(s) must be opened.

- a. To open endshield(s), press against latch in opening at (A) on inboard side of endsheet.

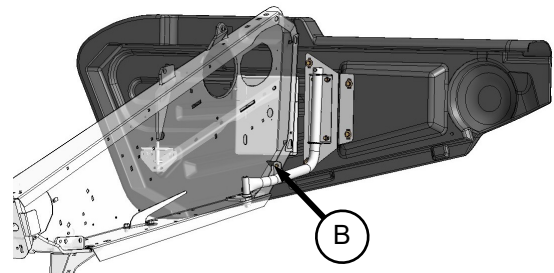
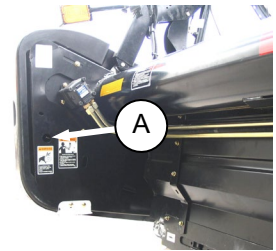

- b. Pull shield away from header and swing it out and back behind the end sheet until the latch (B) engages the hook on the endsheet.

(continued next page)

SECTION IV. PRE-DELIVERY CHECKS

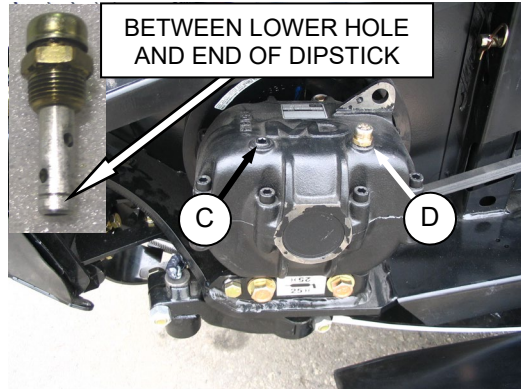

CHECK OIL LEVEL WITH TOP OF WOBBLE BOX HORIZONTAL

- c. Position of plug (C) and breather (D) at wobble box must be as shown.
- d. Check oil level.
- e. Leave endshield(s) open.

D. GEARBOX OIL

- a. Set cutterbar to working position.

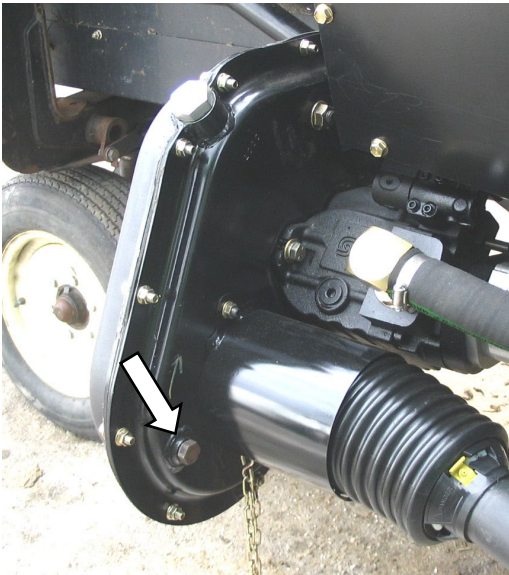

- b. Remove drain plug. Level should be to bottom of drain hole.

E. HYDRAULIC RESERVOIR

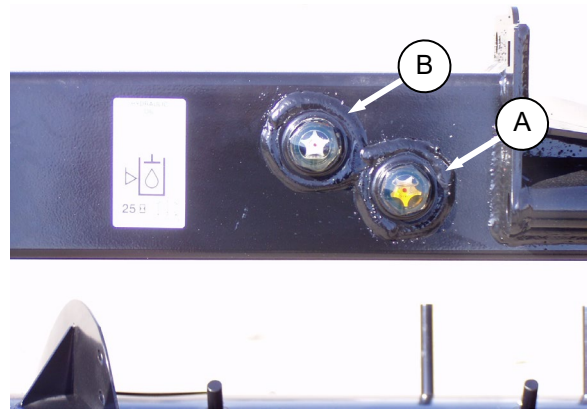

Check oil level at sights (A) and (B) with cutterbar just touching ground. Check when oil is cold and with center link retracted.

Nominal – Normal Terrain: Maintain level so lower sight (A) is full and upper sight (B) is empty.

NOTE

When ambient temperatures are above 35° C (95° F), to prevent overflow at breather under operating temperatures, it may be necessary to lower oil level slightly.

SECTION IV. PRE-DELIVERY CHECKS

F. SICKLE DRIVE BELT TENSION

NOTE

The sickle drive is identical on both sides of the header.

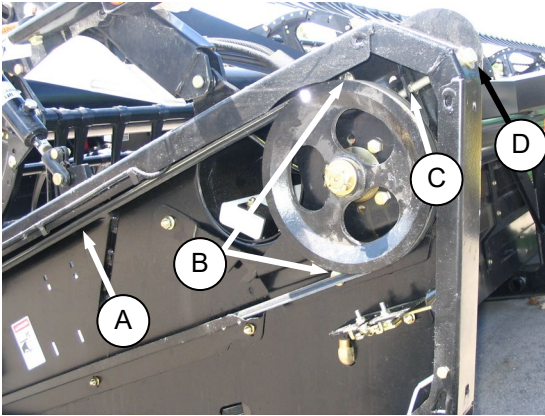

- A force of 20 lbf (80 N) should deflect belt (A) 3/4 in. (18 mm) at mid-span.
- If necessary, adjust tension as follows:
 - Loosen two bolts (B) on sickle drive mounting bracket and jam-nut (C).
 - Turn adjuster bolt (D) to move drive motor until tension is achieved.
 - Tighten jam nut (C) and bolts (B) on drive mounting bracket.

G. REEL CENTERING

- Raise header, shut down combine and engage header lift cylinder stops.
- Place two 6 inch (150 mm) blocks at ends of cutterbar.
- Disengage float locks and header lift cylinder locks.
- Start combine and lower header fully, allowing it to flex into full smile mode.

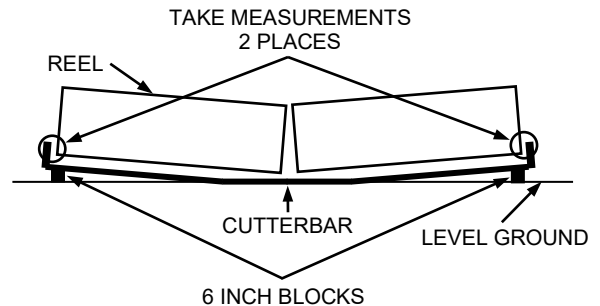

- Shut down engine.



WARNING

Stop /combine engine and remove key before making adjustments to machine. A child or even a pet could engage the drive.

- Measure clearance between reels and both end sheets. The clearances should be the same if the reels are centered.
- If required center the reels as follows:

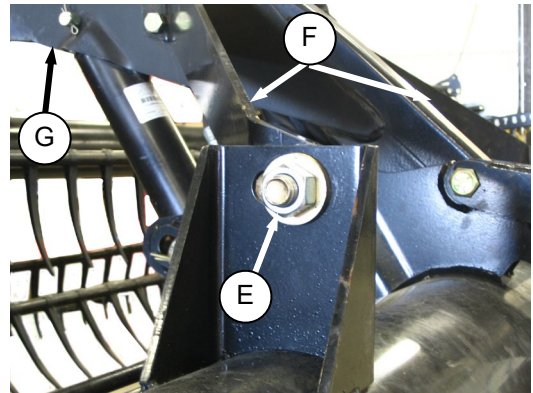

- Loosen bolt (E) on each brace (F).
- Move forward end of centre support arm (G) laterally as required to centre both reels.
- Tighten bolts (E) and torque to 265 ft·lbf (359 N·m).

SECTION IV. PRE-DELIVERY CHECKS

H. DRAPER TENSION

Raise header, and shut down engine. Engage header lift props.



WARNING

Stop combine engine and remove key before making adjustments to machine. A child or even a pet could engage the drive.



CAUTION

Engage header lift cylinder stops before working under header.

- a. Check that draper guide (rubber track on underside of draper) is properly engaged in groove of drive roller and that idler roller is between the guides.

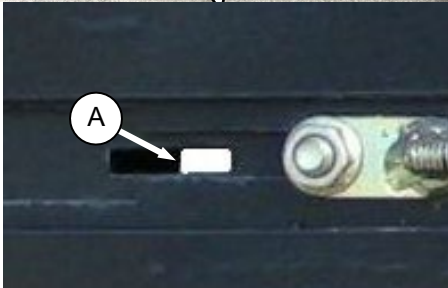
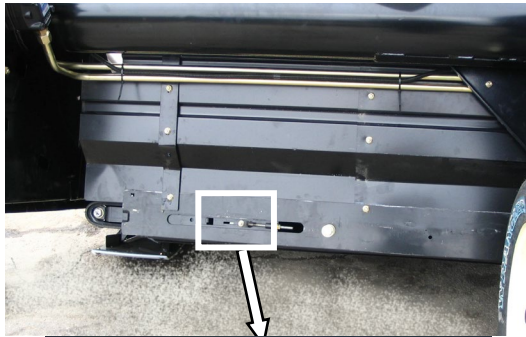

- b. Draper tension should be just enough to prevent slipping and keep draper from sagging below cutterbar. The white bar (A) should be about halfway in the window.

- c. If required, set draper tension as follows:

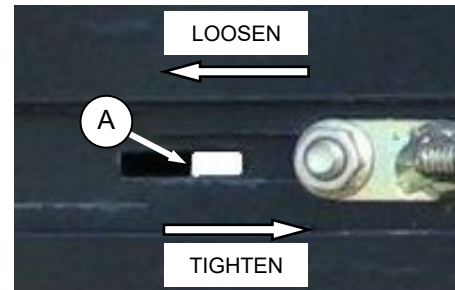
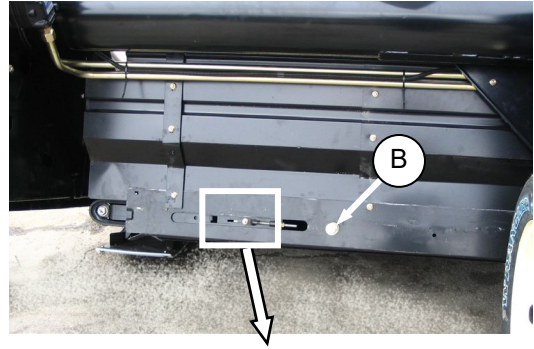

1. Turn bolt (B) clockwise (tighten) and white indicator bar (A) will move inboard in direction of arrow to indicate that draper is tightening.
2. Turn bolt (B) counterclockwise (loosen) and white indicator bar (A) will move outboard in direction of arrow to indicate that draper is loosening.
3. Adjust until bar is about halfway in window.

SECTION IV. PRE-DELIVERY CHECKS

I. HEADER MAIN FLOAT

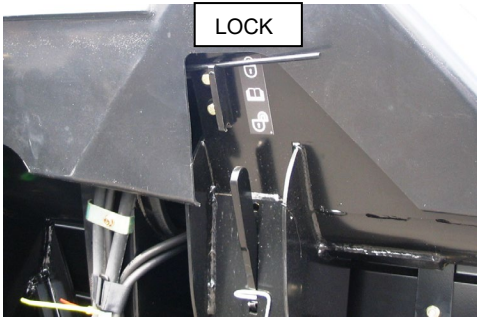

- Ensure both wing float locks are engaged.
- Ensure both header float lock levers are down (UNLOCK).

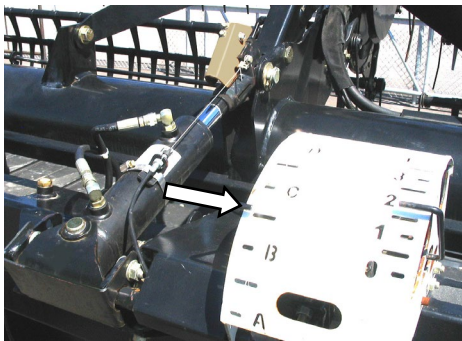

- Start combine and set center link to mid-range (B to C on float/angle indicator if installed). Adjust cutterbar to 6 to 10 inches (150-250 mm) above the ground. Shutdown combine.



WARNING

Stop combine engine and remove key before making adjustments to machine. A child or even a pet could engage the drive.

- If header is equipped with stabilizer wheels or slow speed transport wheels, raise them off the ground so they are supported by the header. Refer to D50 and D60 Harvest Header/FD70 FlexDraper Operator's Manual.

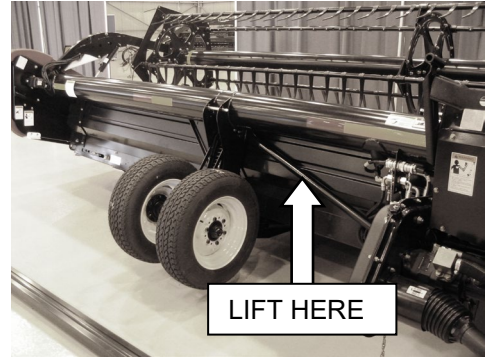

- Lift the header at the rear diagonal brace, or on the back-tube. The header should move up with approximately 75 lbf (334 N) force and then return to its original position.

NOTE

Check movement of bellcranks at base of adapter. They should move forward when the header is lifted and then return to the original position.

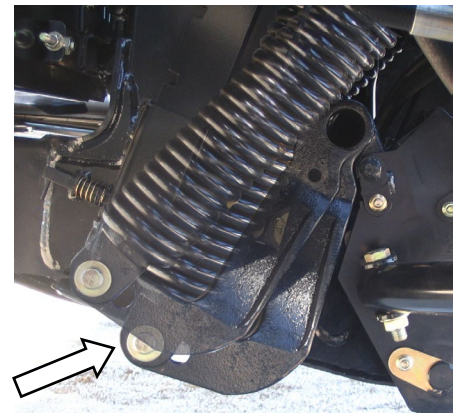

- If excessive force is required, the float adjustment is too low. If the header does not return to its original position, the float adjustment is too high. Adjust as follows:

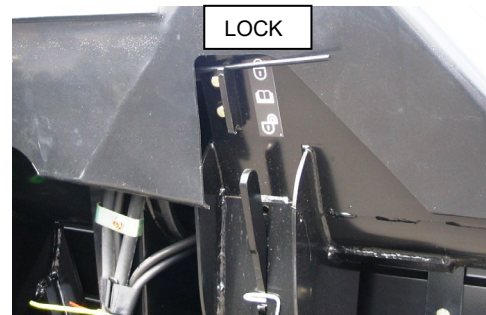

- Ensure both wing float locks are engaged.
(continued next page)

SECTION IV. PRE-DELIVERY CHECKS

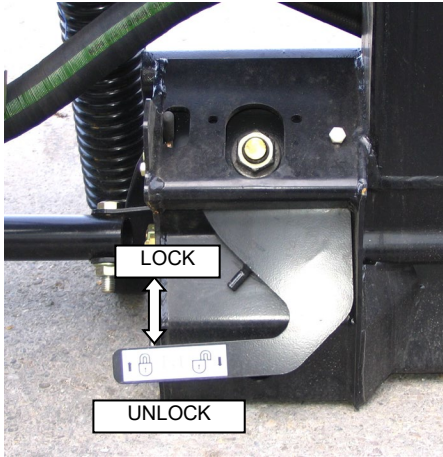

2. Ensure both header float lock levers are down (UNLOCK).

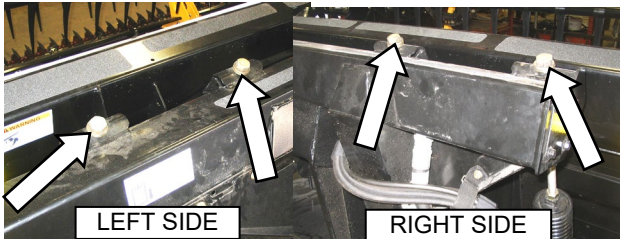

3. Tighten bolts at both sides of adapter to increase float (lightens the header).
4. Loosen bolts to decrease float (increases header weight).

IMPORTANT

Turn each bolt pair equal amounts.

- g. The float is properly adjusted when:
 - for **30, 35, and 40 ft single knife**;
Both sides of the header are adjusted to the same weight (approx. 75 lbf (334 N)).
 - for **40 and 45 ft double knife**;
RH side is slightly heavier (loosen RH side adjuster bolts by 2 turns).

IMPORTANT

Proper float adjustment in accordance with the above is critical for maintaining proper wing balance when cutting on the ground.

SECTION IV. PRE-DELIVERY CHECKS

J. TRIM SPRINGS

Check as follows that the float trim springs are properly installed:

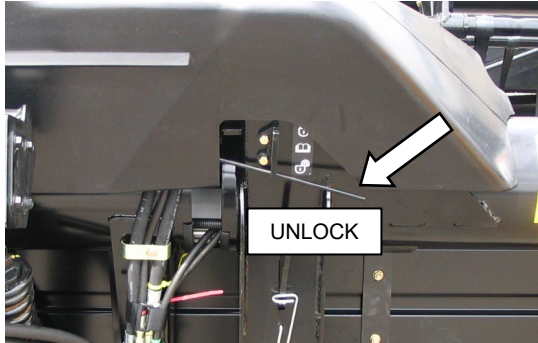

- Place spring handle in the lower slot to UNLOCK.

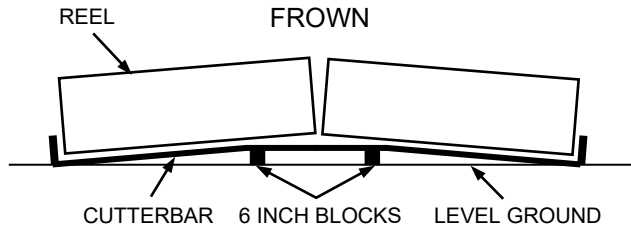

- Place 6 inch (150 mm) blocks under hinge area of cutterbar
- Start combine and fully retract tilt cylinder.
- Lower header onto blocks so that header goes into a full frown, OR

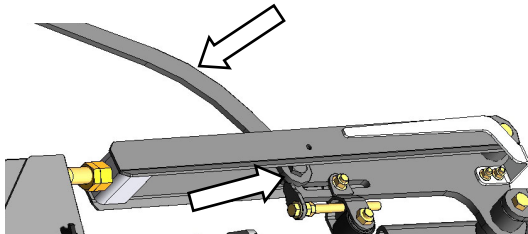

- Position cutterbar approximately 6 in. (150 mm) off the ground, and use special wrench on bolt head to frown the wings one at a time after machine is shutdown.
- Shutdown combine.

NOTE

Wrench is located in RH header leg beneath spring handle.



WARNING

Stop combine engine and remove key before making adjustments to machine. A child or even a pet could engage the drive.

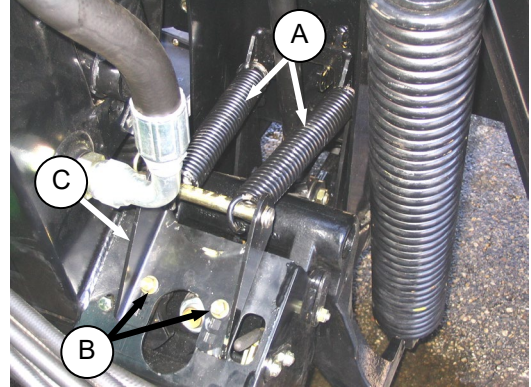

- Check that trim springs (A) are loose (no tension or compression) when the wings are in frown position.
- If necessary, remove bolts (B) and relocate rear trim spring bracket (C) in a different hole so that that springs are loose when tilt cylinder is fully retracted and header is in full frown.

SECTION IV. PRE-DELIVERY CHECKS

K. CUTTERBAR ALIGNMENT

- Set cutterbar on level surface and shutdown combine.



WARNING

Stop combine engine and remove key before making adjustments to machine. A child or even a pet could engage the drive.

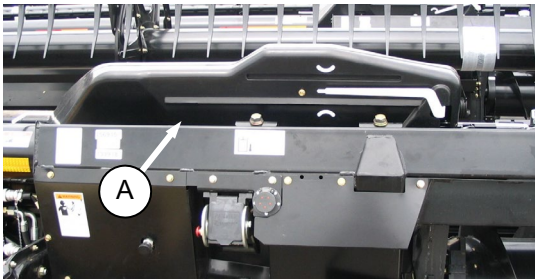

- Remove linkage cover (A).

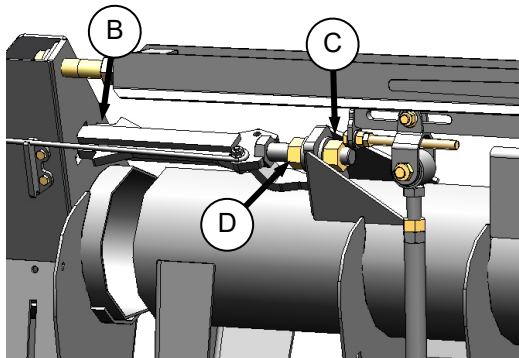

- Check that lock link (B) can be moved up and down in T-slot.
- If not, unlock nuts (C) and (D) and adjust as required until link can be move up and down.
- Tighten nuts (C) and (D) against spacer to 200-250 ft-lbf (270-350 N-m).

L. WING BALANCE

- Extend tilt cylinder 2-3 inches (50-75 mm) and adjust header height so cutterbar is 6-10 inches (150-250 mm) off the ground. Shutdown combine.

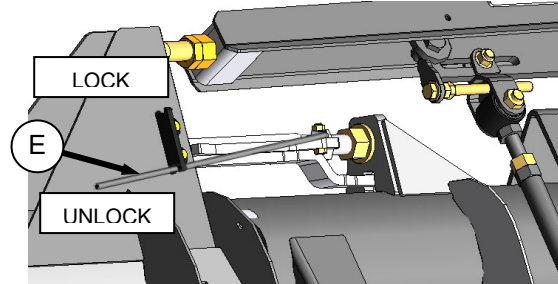

- Place spring handle (E) in the lower slot to UNLOCK.

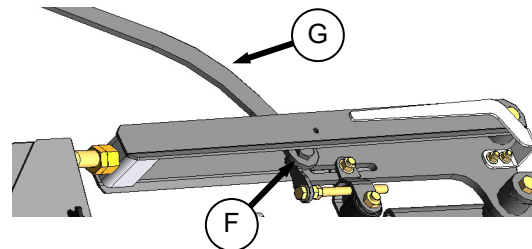

If lock link cannot be moved, apply torque to bolt (F) with wrench (G) to move bell crank and release load in the lock link.

NOTE

Wrench (G) is located in RH header leg beneath spring handle.

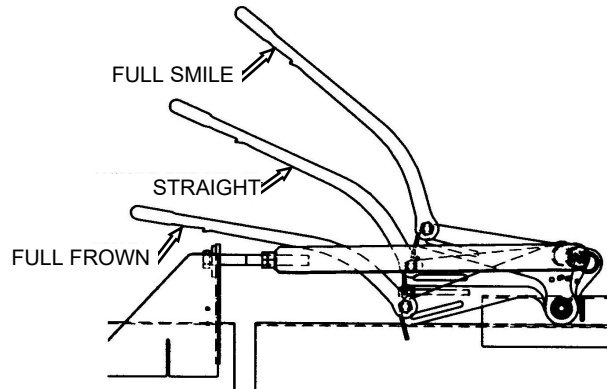

- Move the wing up and down by applying torque to bolt to turn the bell crank. The wing should move to full smile (wing up) and full frown (wing down) with same force on the wrench.

(continued next page)

SECTION IV. PRE-DELIVERY CHECKS

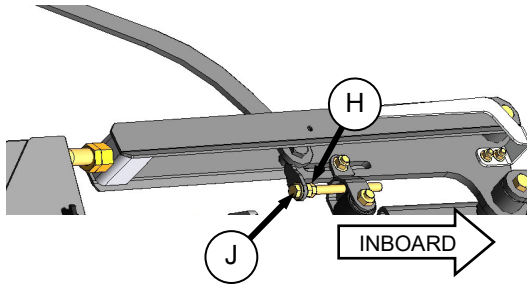

- e. If wing is too light, loosen clamp bolt (H) and turn draw bolt (J) counterclockwise to move the clevis inboard.
- f. If wing is too heavy, turn draw bolt clockwise to move clevis outboard. Tighten clamp bolt (H).

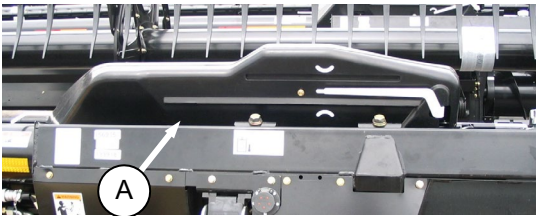

- g. Replace linkage covers (A) and wrench.

SKID SHOE SETTINGS



WARNING

Stop combine engine and remove key before making adjustments to machine. A child or even a pet could engage the drive.



CAUTION

Engage header lift cylinder stops before working under header.

- a. Note the hole positions on the adjuster legs (A) on each skid shoe. They should be the same.
- b. If necessary, adjust as follows:

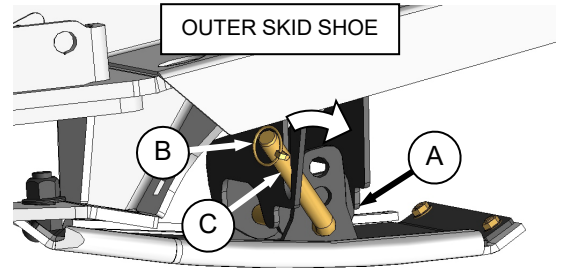
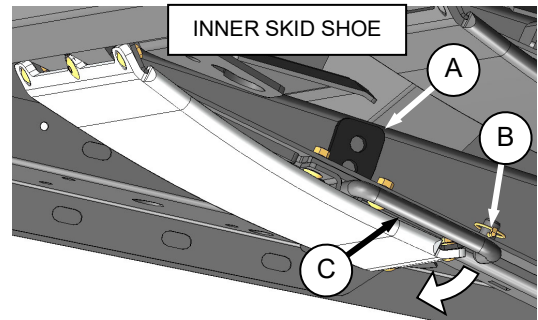

1. Remove lynch pin (B).
2. Hold shoe and remove pin (C) by disengaging frame and then pulling away from shoe.
3. Raise or lower skid shoe to desired position using holes in support as a guide.
4. Reinsert pin (C), engage in frame, and secure with lynch pin (B).
5. Check that skid shoes are adjusted to the same position.

SECTION IV. PRE-DELIVERY CHECKS

N. REEL TINE TO CUTTERBAR CLEARANCE

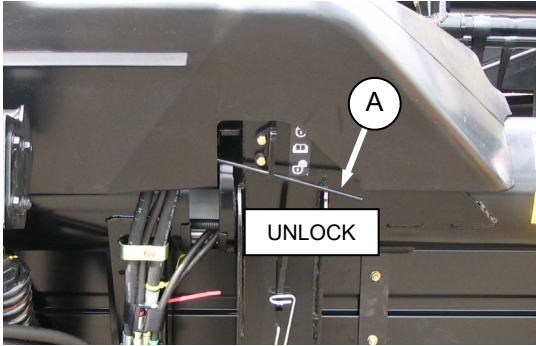

- a. Place spring handle (A) in lower slot to unlock the wings.



CAUTION

Engage header lift cylinder stops before working under header.



WARNING

Stop combine engine and remove key before making adjustments to machine. A child or even a pet could engage the drive.

- b. Raise header, shut down combine and engage header lift cylinder stops.
c. Place two 6 inch (150 mm) blocks just inboard of wing flex points.

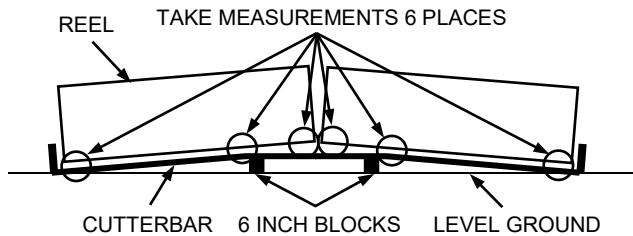

- d. Disengage header lift cylinder locks, start combine and lower header fully, allowing it to flex into full frown mode.

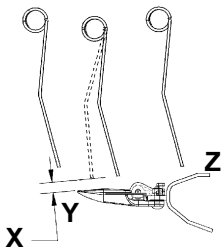

- e. Measure clearance 'X' at ends of each reel.

NOTE

The reel has been adjusted at the factory to provide more clearance at the centre of the reel than at the ends (frown) to compensate for reel flexing.

- f. Measure the clearance 'X' at both flex locations.
g. Check all possible points of contact between points 'Y' and 'Z'. Depending on reel fore-aft position, minimum clearance can occur at guard tine, hold-down or cutterbar.

The finger to guard/cutterbar clearance with reels fully lowered is 0.78 +/- 0.12 in. (20 +/- 3 mm) measured **at both ends of each reel, and at the cutterbar flex locations** with the reel in full frown mode.

- h. If necessary, adjust outside arms as follows:

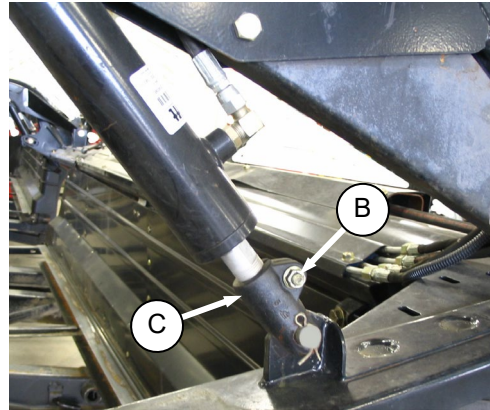

1. Loosen bolt (B).
2. Turn cylinder rod (C) counter-clockwise to raise reel and increase clearance to cutterbar, or clockwise to decrease.
3. Tighten bolt (B).
4. Repeat at opposite side.

(continued next page)

SECTION IV. PRE-DELIVERY CHECKS

- i. If necessary, adjust centre arm as follows:

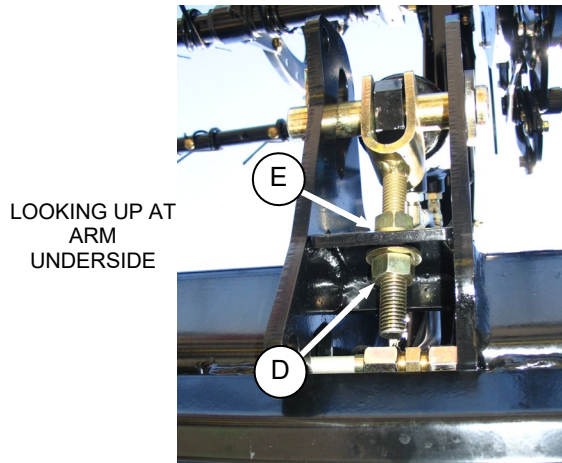

1. Loosen nut (D).
2. Turn nut (E) clockwise to raise reel and increase clearance to cutterbar, or counter-clockwise to decrease.
3. Tighten bolt (D).

SECTION IV. PRE-DELIVERY CHECKS

O. LUBRICATE HEADER

Refer to the illustrations for lubrication points:

- Wipe grease fitting with a clean cloth before greasing, to avoid injecting dirt and grit.
- Inject grease through fitting with grease gun until grease overflows fitting, except where noted.
- Leave excess grease on fitting to keep out dirt.
- Replace any loose or broken fittings immediately.
- If fitting will not take grease, remove and clean thoroughly. Also clean lubricant passageway. Replace fitting if necessary.
- Use clean grease as shown.

High Temp. Extreme Pressure
(EP2) Performance With 1%
Max Molybdenum Disulphide
(NLGI Grade 2).Lithium Base

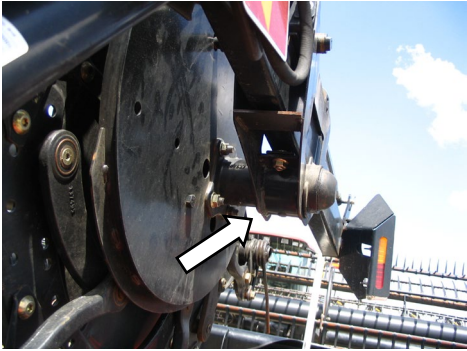

REEL SHAFT RH BEARING (1 PLC)

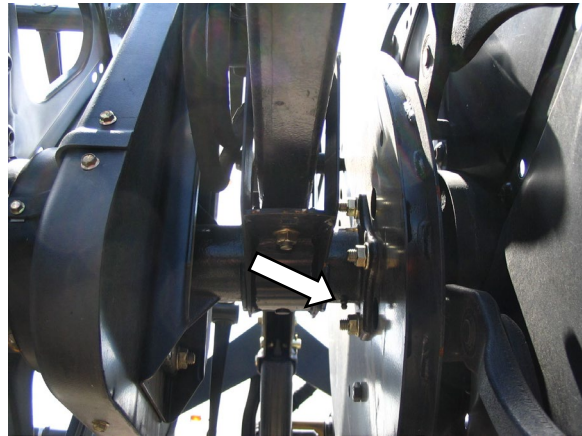

REEL CENTRE BEARING (1 PLC)

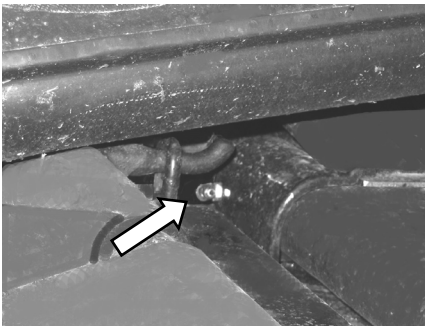

ADAPTER IDLER ROLLER (2 PLCS)

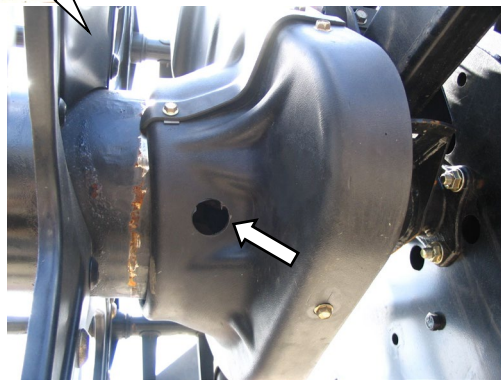

REEL UNIVERSAL (1 PLC)

(continued next page)

SECTION IV. PRE-DELIVERY CHECKS

High Temp. Extreme Pressure
(EP2) Performance With 1%
Max Molybdenum Disulphide
(NLGI Grade 2), Lithium Base



REEL SHAFT LH BEARING (1 PLC)

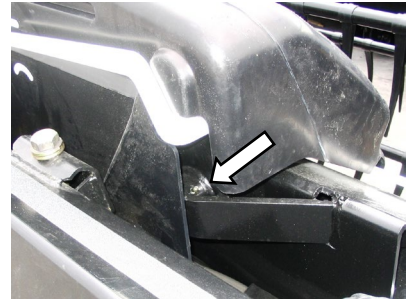

FLEX LINKAGE (BOTH SIDES)

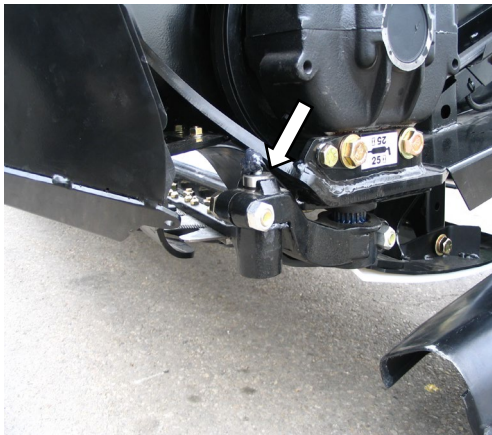

SICKLE HEAD
(1 PLC SINGLE KNIFE/2 PLC DOUBLE KNIFE)

NOTE

To prevent binding and/or excessive wear caused by sickle pressing on guards, do not over grease. If more than 6 to 8 pumps of the grease gun are required to fill the cavity, replace the seal in the sickle head.

(continued next page)

SECTION IV. PRE-DELIVERY CHECKS

High Temp. Extreme Pressure
(EP2) Performance With 1%
Max Molybdenum Disulphide
(NLGI Grade 2).Lithium Base

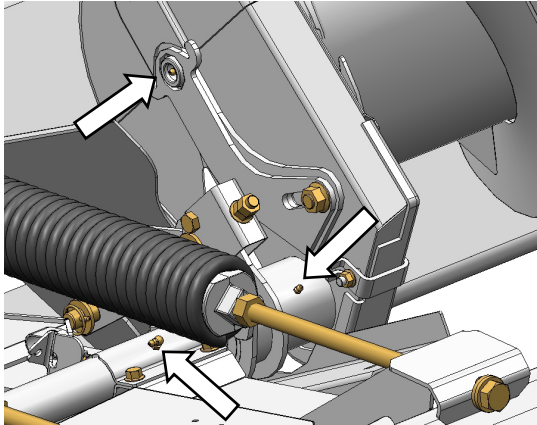

AUGER DRIVE (2 PLCS) AND PIVOT

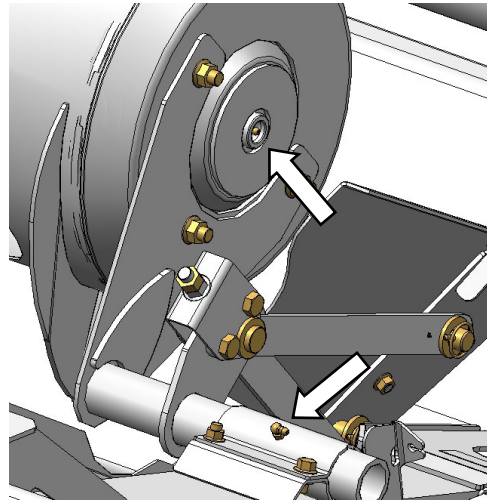

AUGER BEARING AND PIVOT

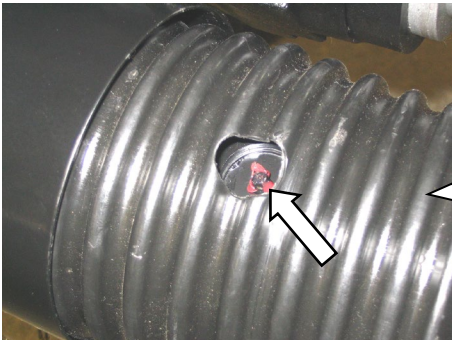

DRIVE UNIVERSAL – (2 PLCS.)

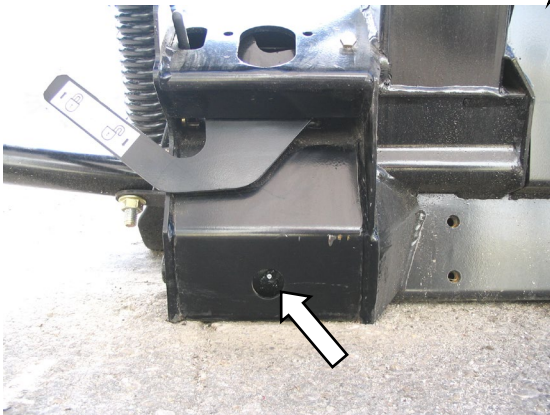
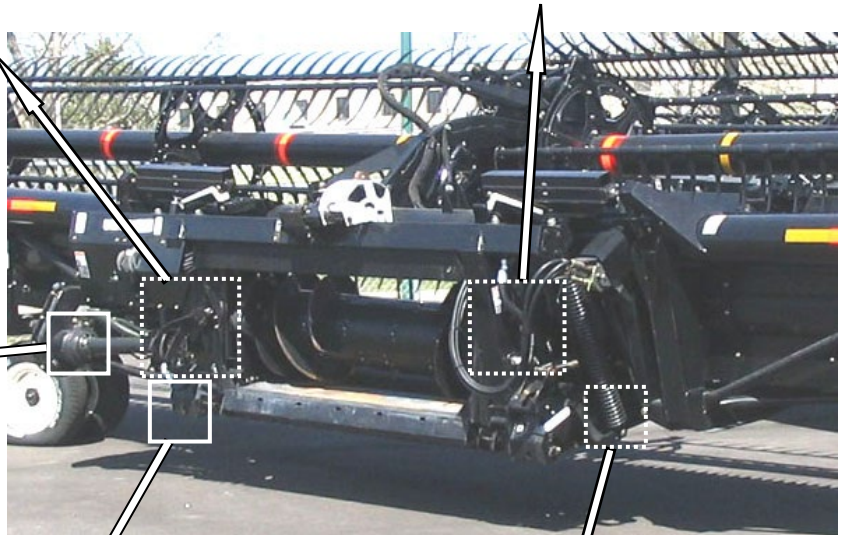

FLOAT PIVOT – BOTH SIDES

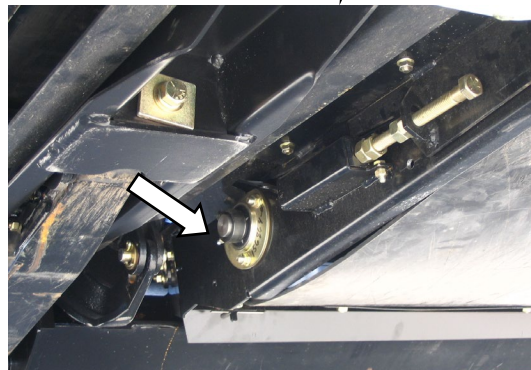

DRIVE ROLLER BEARING (1 PLC)

SECTION IV. PRE-DELIVERY CHECKS

P. ENDSHIELDS

NOTE

Plastic endshields are subject to expansion or contraction depending on large temperature variations. Latch pin and hinge can be adjusted to compensate for dimensional changes.

- a. If hinged endshields are not closed, close as follows: Otherwise, go to step b.

Located on LH end on SK headers and on both ends on DK headers.

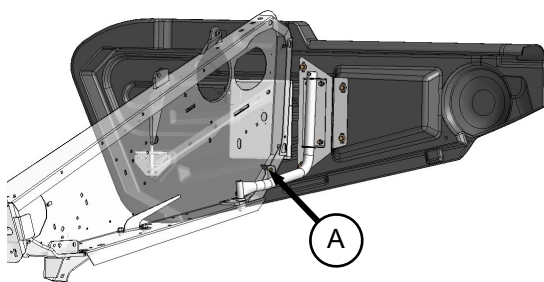

1. To close, shield, release latch (A) and swing the shield forward until the front engages the crop divider (B).



2. Push in shield opposite latch and shield will self-latch.

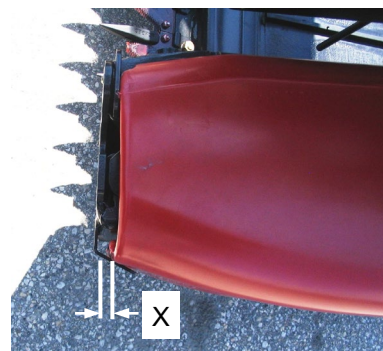

- b. Check gap "X" between the front end of the shields and the header frame and compare against values in chart.

TEMPERATURE Deg. F. (C.)	GAP 'X' Inches (mm)
25 (-4)	1.1 (28)
45 (7)	1.0 (24)
65 (18)	0.79 (20)
85 (29)	0.64 (16)
105 (41)	0.5 (12)
125 (52)	0.32 (8)
145 (63)	0.16 (4)
165 (89)	0

- c. If necessary, adjust the gap as follows:

Hinged Type

1. Open endshield(s) by pressing against latch in opening at (C) on inboard side of endsheet.

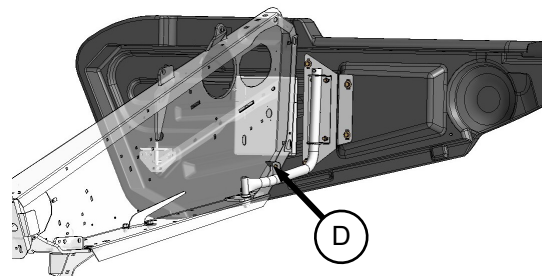
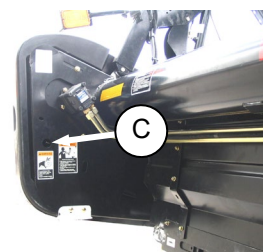

2. Pull shield away from header and swing it out and back behind the end sheet until the latch (D) engages the hook on the endsheet.

SECTION IV. PRE-DELIVERY CHECKS

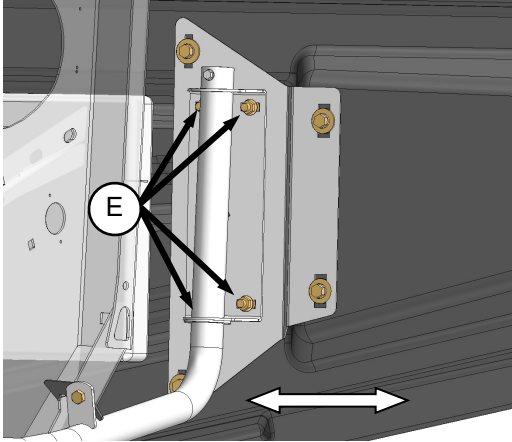

3. Loosen bolts (E) on support.

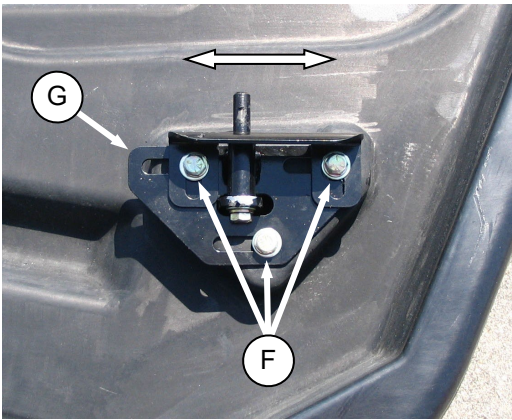

4. Loosen bolts (F) on latch assembly (G).
5. Adjust the endshield to achieve the gap 'X' between the front end of the shield and the header frame in accordance with the chart.
6. Tighten bolts

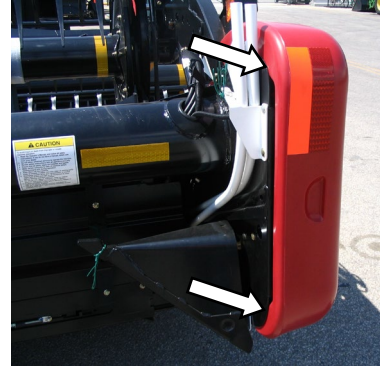
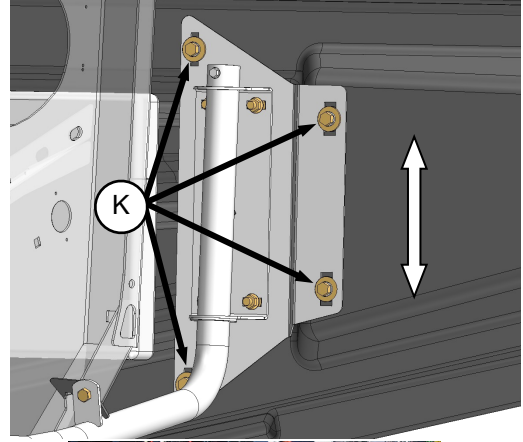

9. Loosen bolts (K) on endshield support and adjust endshield to align with endsheet as shown above.
10. Tighten bolts (H) and (K).
11. Close shield(s) and recheck fitment.

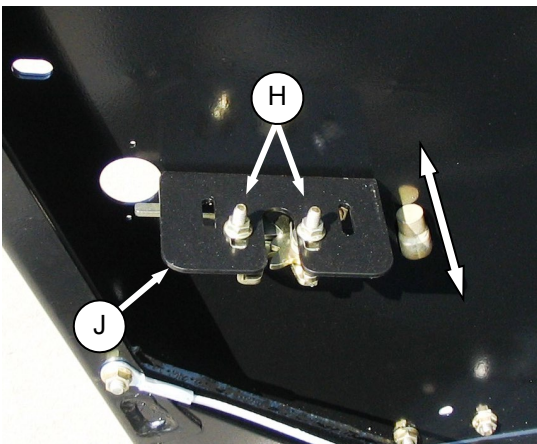

7. To achieve a snug fit between the aft end of the shield and header frame:
8. Loosen bolts (H) and adjust the latch (J) to reposition the shield.

SECTION IV. PRE-DELIVERY CHECKS

Non-Hinged Type

Located on RH end of SK headers.

1. Press against latch in opening at (A) on inboard side of endsheet.

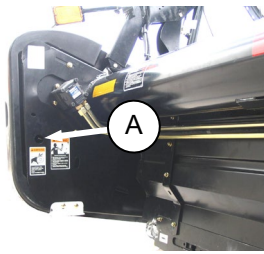

2. Lift up on shield, pull out and back to remove shield.

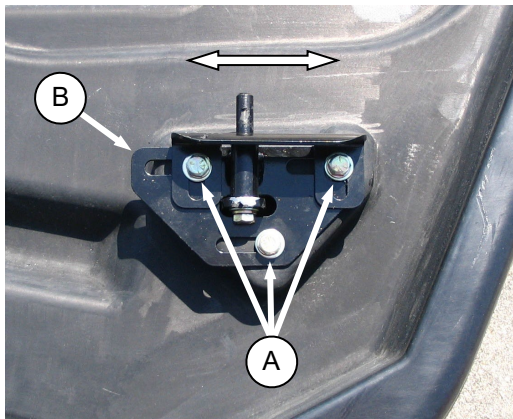

3. Loosen bolts (A) on latch assembly (B).

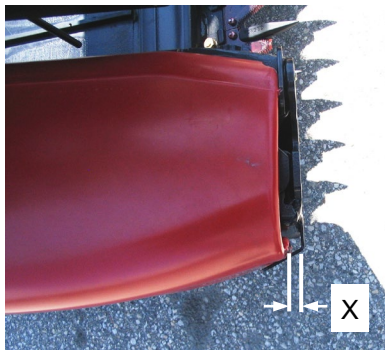

4. Adjust endshield to achieve the gap 'X' between front end of shield and header frame in accordance with the chart on previous page.
5. Tighten bolts (A).

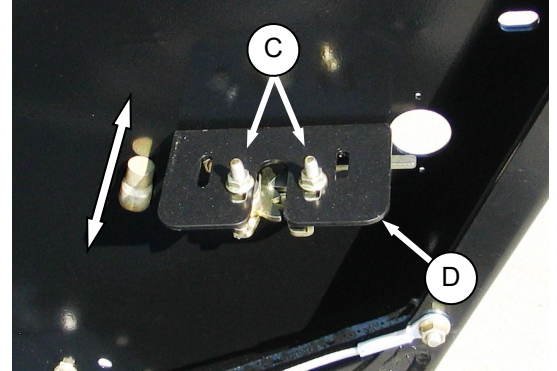
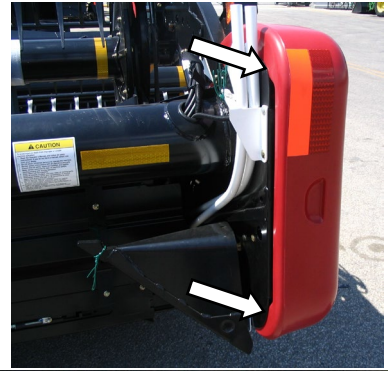

6. To achieve a snug fit between aft end of shield and header frame, loosen bolts (C) and adjust latch (D) to reposition shield.

7. Tighten bolts (C).

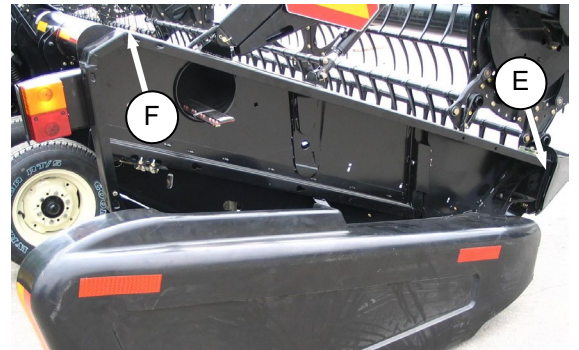

8. To install shield, locate forward end in crop divider (E) and position shield over end sheet. Pin (F) at top of end sheet must engage shield.



9. Push in shield where shown (opposite latch) and shield will self-latch.

SECTION IV. PRE-DELIVERY CHECKS

Q. OPERATOR'S MANUAL AND PARTS CATALOGS

Check case contents. The manual case is located inside the LH endshield.

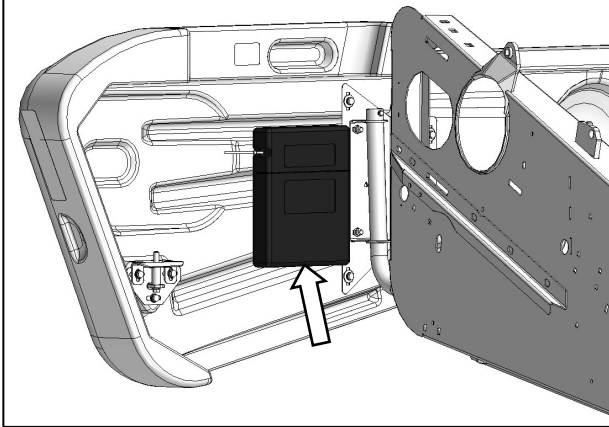

- D50 and D60 Harvest Header / FD70 FlexDraper Combine Operator's Manual #169006.
- D50 and D60 Harvest Header / FD70 FlexDraper Parts Catalog #169008.
- CA20 Combine Adapter Parts Catalog #169011.

SECTION V. HEADER RUN-UP

SECTION V. HEADER RUN-UP

STEP 1. RUN-UP THE HEADER

- a. Start combine, raise header fully, and engage header lift cylinder locks. Shutdown combine and remove key.



WARNING

Stop combine engine and remove key before making adjustments to machine. A child or even a pet could engage the drive.



CAUTION

Engage header lift cylinder stops before working under header.

- b. Lower poly pan under adapter and check for shipping materials/debris that may have fallen under adapter draper as follows:

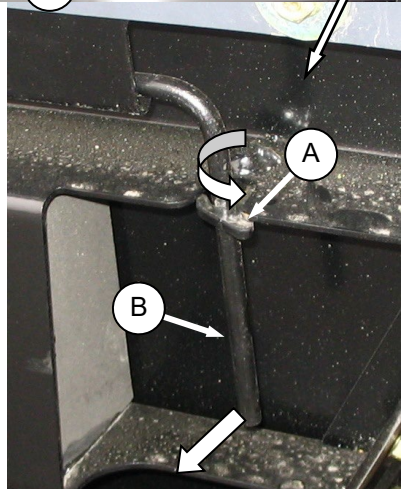
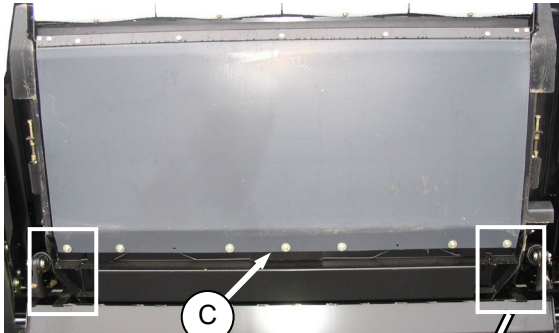

1. Rotate latches (A) to unlock handle (B).
2. Hold pan (C) and rotate handle (B) to release pan. Lower pan to expose draper.

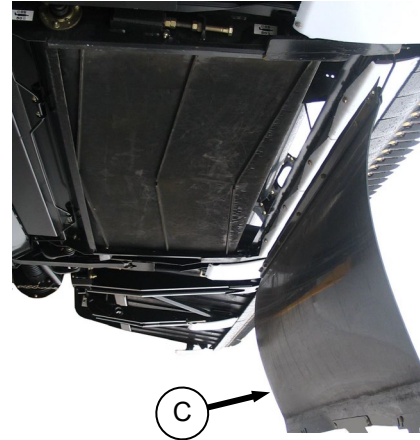

3. Check and remove debris from pan (C) and draper.

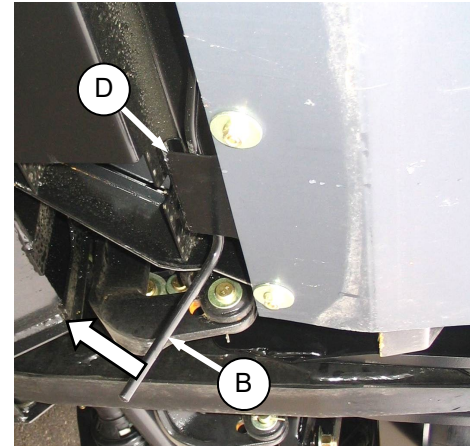

4. Raise pan and rotate handle (B) so that rod engages clips (D) on pan.

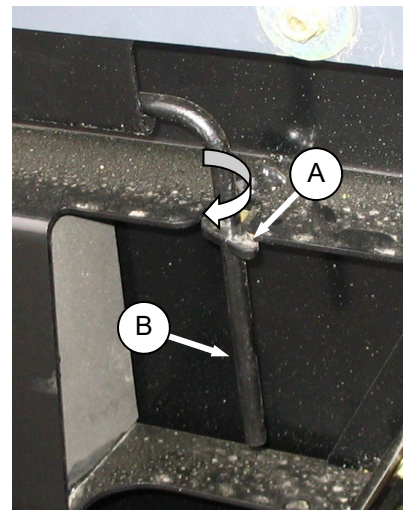

5. Push handle (B) into slot and secure with latches (A).

(continued next page)

SECTION V. HEADER RUN-UP



CAUTION

Never start or move the machine until you are sure all bystanders have cleared the area.



CAUTION

Clear the area of other persons, pets etc. Keep children away from machinery. Walk around the machine to be sure no one is under, on or close to it.



CAUTION

Before investigating an unusual sound or attempting to correct a problem, shut off engine, engage parking brake and remove key.

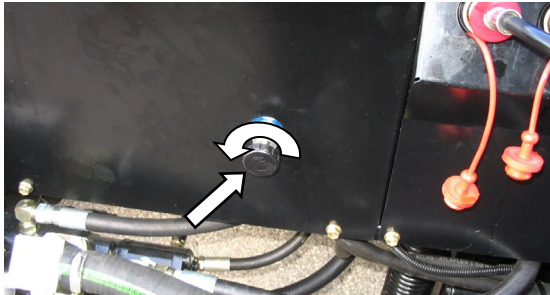

- c. Open side draper flow control 2 turns.
- d. Ensure feeder house variable speed is set to minimum.
- e. Start combine and run the machine for 15 minutes.
- f. Perform the run-up check as listed on the "Pre-Delivery Checklist" (yellow sheet attached to this instruction) to ensure the machine is field-ready.

STEP 2. POST RUN-UP ADJUSTMENTS

The following adjustments may be necessary after the run-up:



WARNING

Stop combine engine and remove key before making adjustments to machine. A child or even a pet could engage the drive.

- a. Check guards for signs of heating during run-up due to insufficient clearance between guard and sickle. If heating is evident, proceed as follows:

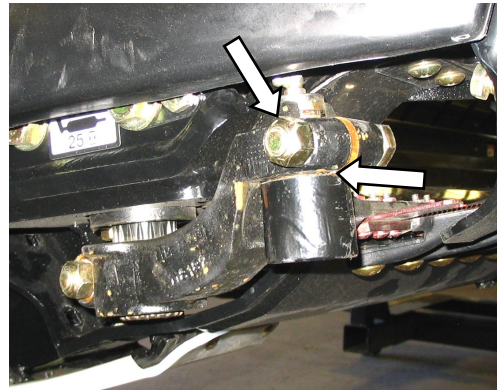

1. Check gap between knife head and pitman arm. A business card should slide easily through the gap. If not, then adjust gap by loosening bolt and tapping knife head with a hammer. Re-tighten bolt.
- b. Adjust guard alignment as follows: The guard straightening tool (MacDon #140135) is available from your dealer:



UPWARD ADJUSTMENT

1. To adjust guard tips upwards, position tool as shown at and pull up.



DOWNWARD ADJUSTMENT

2. To adjust tips downward, position tool as shown and push down.

NOTES

Model FD70 FlexDraper/CA20 Combine Adapter Pre-Delivery Checklist – N.A.

Perform these checks prior to delivery to your customer. **Adjustments are normally not required as the machine is factory assembled and adjusted.** If adjustments are required, refer to the appropriate page number in this manual. The completed checklist should be retained either by the operator or the dealer.



CAUTION: Carefully follow the instructions given. Be alert for safety related messages which bring your attention to hazards and unsafe practices.

Header Serial Number: _____

Adapter Serial Number: _____

✓	<u>ITEM</u>	<u>PAGE</u>
	Check for shipping damage or missing parts. Be sure all shipping dunnage is removed.	-
	Check for loose hardware. Tighten to required torque.	5
	Check tire pressure (Transport/Stabilizer Option).	60
	Check wheel bolt torque (Transport/Stabilizer Option).	60
	Check wobble box breather position.	60
	Check wobble box lube level.	60
	Check adapter gearbox box lube level.	61
	Check hydraulic reservoir lube level before and after run-up.	61
	Check sickle drive belt(s) tension.	62
	Check reel centered between header endsheets (header in full smile).	62
	Grease all bearings and drivelines.	70
	Check side draper tension.	63
	Check wing balance.	67
	Check cutterbar alignment.	67
	Check header main float.	64
	Check reel tine to cutterbar clearance.	69
	Check skid shoes are evenly adjusted at a setting appropriate for first crop.	68
	Check fitment of endshields.	74
	Ensure feeder house variable speed is set to minimum.	-
	RUN-UP PROCEDURE	78
	Check hydraulic hose and wiring harness routing for clearance when raising or lowering header and reel.	-
	Check lights are functional.	59
	POST RUN-UP CHECK. STOP ENGINE.	79
	Check belt and chain drives for heated bearings.	12 & 62
	Check knife sections for discolouration caused by misalignment of components.	77
	Check for hydraulic leaks.	-
	Check manual storage case contains Operator's Manual and Parts Catalogs.	77

Date Checked: _____

Checked by: _____

MacDon™

MacDon Industries Ltd.

680 Moray Street
Winnipeg, Manitoba
Canada R3J 3S3
t. (204) 885-5590
f. (204) 832-7749

MacDon Inc.

10708 N. Pomona Avenue
Kansas City, Missouri
United States, 64153-1924
t. (816) 891-7313
f. (816) 891-7323

MacDon Australia Pty. Ltd.

A.C.N. 079 393 721
P.O. Box 243
Suite 3, 143 Main Street
Greensborough, Victoria
Australia 3088
t. 03 9432 9982
f. 03 9432 9972

CUSTOMERS

www.macdon.com

DEALERS

www.macdondealers.com

Trademarks of products are the marks of their
respective manufacturers and/or distributors.

Printed in Canada