

**MacDon™**

**Model FD70 FlexDraper®  
with  
CA20 Combine Adapter**

**UNLOADING &  
ASSEMBLY INSTRUCTIONS  
for  
NORTH AMERICAN SHIPMENTS**



**MacDon FD70 FlexDraper with CA20 Combine Adapter**

# INTRODUCTION

This instruction describes the unloading, set-up and pre-delivery requirements for the MacDon FD70 FlexDraper with a CA20 Combine Adapter. Use the table of contents to guide you to specific areas. Retain this instruction for future reference.

CAREFULLY READ ALL THE MATERIAL PROVIDED BEFORE ATTEMPTING TO UNLOAD, ASSEMBLE, OR USE THE MACHINE.

## TABLE OF CONTENTS

|  |    |
|--|----|
| INTRODUCTION.....  | 1  |
| GENERAL SAFETY.....  | 2  |
| RECOMMENDED TORQUES.....   | 4  |
| A.    GENERAL.....   | 4  |
| B.    SAE BOLTS.....   | 4  |
| C.    METRIC BOLTS.....  | 4  |
| D.    HYDRAULIC FITTINGS.....  | 5  |
| ENGLISH/METRIC EQUIVALENTS.....  | 6  |
| STEP 1.    UNLOAD HEADER.....  | 7  |
| A.    SINGLE FORKLIFT METHOD.....  | 7  |
| B.    COMBINE METHOD.....  | 8  |
| C.    TWO FORKLIFT METHOD.....   | 9  |
| STEP 2.    REPOSITION GEARBOX.....   | 10 |
| STEP 3.    INSTALL REEL SPEED SENSOR.....                                      | 11 |
| A.    REMOVE COVER.....  | 11 |
| B.    JOHN DEERE SENSOR INSTALLATION.....                                      | 13 |
| C.    LEXION 500 SERIES SENSOR INSTALLATION.....                               | 15 |
| D.    LEXION 400 SERIES SENSOR INSTALLATION.....                               | 17 |
| E.    AGCO SENSOR INSTALLATION.....  | 19 |
| F.    INSTALL COVER.....   | 20 |
| STEP 4.    INSTALL OPTIONS.....  | 20 |
| STEP 5.    ATTACH TO COMBINE.....  | 21 |
| A.    CASE NEW HOLLAND.....  | 21 |
| B.    JOHN DEERE 60 SERIES.....  | 24 |
| C.    JOHN DEERE 50 SERIES.....  | 26 |
| D.    LEXION.....  | 28 |
| E.    AGCO.....  | 32 |
| STEP 6.    REMOVE SHIPPING SUPPORTS.....                                       | 35 |
| STEP 7.    POSITION TRANSPORT LIGHTS.....                                      | 35 |
| STEP 8.    INSTALL CROP DIVIDERS.....  | 36 |
| STEP 9.    PERFORM PRE-DELIVERY CHECKS.....                                    | 37 |
| A.    TIRE PRESSURE - SLOW SPEED TRANSPORT & STABILIZER WHEEL OPTIONS.....     | 37 |
| B.    WHEEL BOLT TORQUE - SLOW SPEED TRANSPORT & STABILIZER WHEEL OPTIONS..... | 37 |
| C.    WOBBLE BOX.....  | 37 |
| D.    GEARBOX OIL.....   | 38 |
| E.    HYDRAULIC RESERVOIR.....   | 38 |
| F.    SICKLE DRIVE BELT TENSION.....   | 38 |
| G.    REEL CENTERING.....  | 39 |
| H.    DRAPER TENSION.....  | 40 |
| I.    HEADER MAIN FLOAT.....   | 41 |
| J.    TRIM SPRINGS.....  | 43 |
| J.    TRIM SPRINGS.....  | 43 |
| K.    CUTTERBAR ALIGNMENT.....   | 44 |
| L.    WING BALANCE.....  | 44 |
| M.    SKID SHOE SETTINGS.....  | 45 |
| N.    REEL TINE TO CUTTERBAR CLEARANCE.....                                    | 46 |
| O.    LUBRICATE HEADER.....  | 47 |
| P.    OPERATOR'S MANUALS AND PARTS CATALOGUES.....                             | 50 |
| Q.    INSTALL END SHIELDS.....   | 50 |
| STEP 10.   RUN-UP THE HEADER.....  | 52 |
| STEP 11.   POST RUN-UP ADJUSTMENTS.....  | 53 |

# GENERAL SAFETY



## CAUTION

- The following are general farm safety precautions that should be part of your operating procedure for all types of machinery.

- Protect yourself.

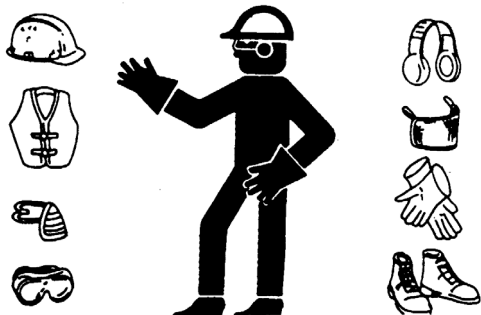

- When assembling, operating and servicing machinery, wear all the protective clothing and personal safety devices that **COULD** be necessary for the job at hand. Don't take chances.

- You may need:

- a hard hat.
- protective shoes with slip resistant soles.
- protective glasses or goggles.
- heavy gloves.
- wet weather gear.
- respirator or filter mask.
- hearing protection. Be aware that prolonged exposure to loud noise can cause impairment or loss of hearing. Wearing a suitable hearing protective device such as ear muffs (A) or ear plugs (B) protects against objectionable or loud noises.

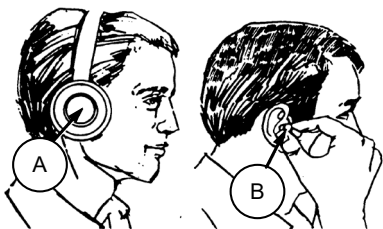

- Provide a first-aid kit for use in case of emergencies.
- Keep a fire extinguisher on the machine. Be sure the extinguisher is properly maintained and be familiar with its proper use.
- Keep young children away from machinery at all times.
- Be aware that accidents often happen when the operator is tired or in a hurry to get finished. Take the time to consider the safest way. Never ignore warning signs of fatigue.
- Wear close-fitting clothing and cover long hair. Never wear dangling items such as scarves or bracelets.
- Keep hands, feet, clothing and hair away from moving parts. Never attempt to clear obstructions or objects from a machine while the engine is running.

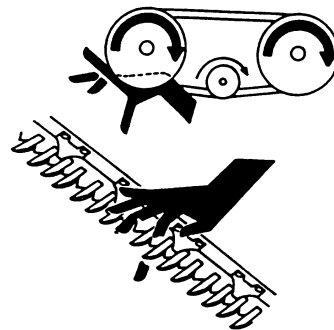

- Keep all shields in place. Never alter or remove safety equipment. Make sure driveline guards can rotate independently of the shaft and can telescope freely.

- Use only service and repair parts made or approved by the equipment manufacturer. Substituted parts may not meet strength, design, or safety requirements.
- Do not modify the machine. Unauthorized modifications may impair the function and/or safety and affect machine life.
- Stop engine and remove key from ignition before leaving operator's seat for any reason. A child or even a pet could engage an idling machine.



- Keep the area used for servicing machinery clean and dry. Wet or oily floors are slippery. Wet spots can be dangerous when working with electrical equipment. Be sure all electrical outlets and tools are properly grounded.
- Use adequate light for the job at hand.
- Keep machinery clean. Do not allow oil or grease to accumulate on service platforms, ladders or controls. Clean machines before storage.
- Never use gasoline, naphtha or any volatile material for cleaning purposes. These materials may be toxic and/or flammable.
- When storing machinery, cover sharp or extending components to prevent injury from accidental contact.

# RECOMMENDED TORQUES

## A. GENERAL

The tables shown below give correct torque values for various bolts and capscrews.

- Tighten all bolts to the torques specified in chart unless otherwise noted throughout this manual.
- Check tightness of bolts periodically, using bolt torque chart as a guide.
- Replace hardware with the same strength bolt.
- Torque figures are valid for non-greased or non-oiled threads and heads unless otherwise specified. Do not grease or oil bolts or capscrews unless specified in this manual. When using locking elements, increase torque values by 5%.

## B. SAE BOLTS

| BOLT DIA. "A" | NC BOLT TORQUE |     |        |      |
|---------------|----------------|-----|--------|------|
|               | SAE 5          |     | SAE 8  |      |
|               | ft·lbf         | N·m | ft·lbf | N·m  |
| 1/4"          | 9              | 12  | 11     | 15   |
| 5/16"         | 18             | 24  | 25     | 34   |
| 3/8"          | 32             | 43  | 41     | 56   |
| 7/16"         | 50             | 68  | 70     | 95   |
| 1/2"          | 75             | 102 | 105    | 142  |
| 9/16"         | 110            | 149 | 149    | 202  |
| 5/8"          | 150            | 203 | 200    | 271  |
| 3/4"          | 265            | 359 | 365    | 495  |
| 7/8"          | 420            | 569 | 600    | 813  |
| 1"            | 640            | 867 | 890    | 1205 |

\* Torque categories for bolts and capscrews are identified by their head markings.

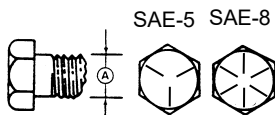

## C. METRIC BOLTS

| BOLT DIA. "A" | NC BOLT TORQUE* |      |        |      |
|---------------|-----------------|------|--------|------|
|               | 8.8             |      | 10.9   |      |
|               | ft·lbf          | N·m  | ft·lbf | N·m  |
| M3            | 0.4             | 0.5  | 1.3    | 1.8  |
| M4            | 2.2             | 3    | 3.3    | 4.5  |
| M5            | 4               | 6    | 7      | 9    |
| M6            | 7               | 10   | 11     | 15   |
| M8            | 18              | 25   | 26     | 35   |
| M10           | 37              | 50   | 52     | 70   |
| M12           | 66              | 90   | 92     | 125  |
| M14           | 103             | 140  | 148    | 200  |
| M16           | 166             | 225  | 229    | 310  |
| M20           | 321             | 435  | 450    | 610  |
| M24           | 553             | 750  | 774    | 1050 |
| M30           | 1103            | 1495 | 1550   | 2100 |
| M36           | 1917            | 2600 | 2710   | 3675 |

\* Torque categories for bolts and capscrews are identified by their head markings.

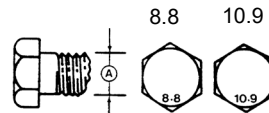

## D. HYDRAULIC FITTINGS

### O-RING TYPE

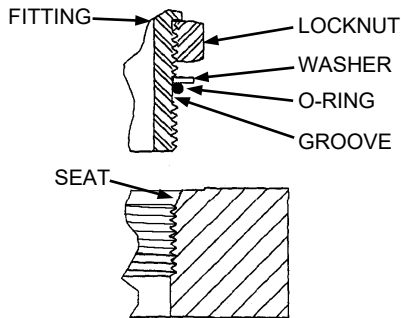

- a. Inspect O-ring and seat for dirt or obvious defects.

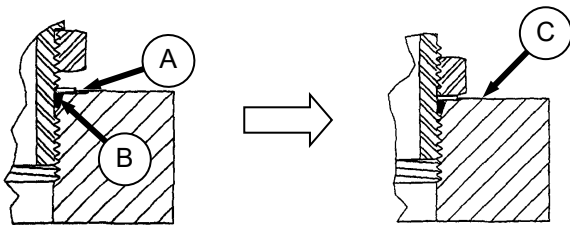

- b. On angle fittings, back off the lock nut until washer (A) bottoms out at top of groove (B) in fitting.
- c. Hand tighten fitting until back up washer (A) or washer face (if straight fitting) bottoms on part face (C) and O-ring is seated.
- d. Position angle fittings by unscrewing no more than one turn.

| THD SIZE (in.) | NUT SIZE ACROSS FLATS (in.) | TORQUE VALUE* |     | RECOMMENDED TURNS TO TIGHTEN (AFTER FINGER TIGHTENING) |       |
|----------------|-----------------------------|---------------|-----|--|-------|
|                |                             | ft·lbf        | N·m | Flats  | Turns |
| 3/8            | 1/2                         | 6             | 8   | 2  | 1/3   |
| 7/16           | 9/16                        | 9             | 12  | 2  | 1/3   |
| 1/2            | 5/8                         | 12            | 16  | 2  | 1/3   |
| 9/16           | 11/16                       | 18            | 24  | 2  | 1/3   |
| 3/4            | 7/8                         | 34            | 46  | 2  | 1/3   |
| 7/8            | 1                           | 46            | 62  | 1-1/2  | 1/4   |
| 1-1/16         | 1-1/4                       | 75            | 102 | 1  | 1/6   |
| 1-3/16         | 1-3/8                       | 90            | 122 | 1  | 1/6   |
| 1-5/16         | 1-1/2                       | 105           | 142 | 3/4  | 1/8   |
| 1-5/8          | 1-7/8                       | 140           | 190 | 3/4  | 1/8   |
| 1-7/8          | 2-1/8                       | 160           | 217 | 1/2  | 1/12  |

\* The torque values shown are based on lubricated connections as in reassembly.

- e. Tighten straight fittings to torque shown.
- f. Tighten angle fittings to torque shown in the following table while holding body of fitting with a wrench.

### FLARE TYPE

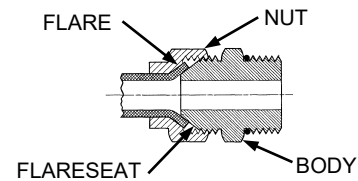

- a. Check flare and flare seat for defects that might cause leakage.
- b. Align tube with fitting before tightening.
- c. Lubricate connection and hand tighten swivel nut until snug.
- d. To prevent twisting the tube(s), use two wrenches. Place one wrench on the connector body and with the second tighten the swivel nut to the torque shown.

| TUBE SIZE O.D. (in.) | NUT SIZE ACROSS FLATS (in.) | TORQUE VALUE* |     | RECOMMENDED TURNS TO TIGHTEN (AFTER FINGER TIGHTENING) |       |
|----------------------|-----------------------------|---------------|-----|--|-------|
|                      |                             | ft·lbf        | N·m | Flats  | Turns |
| 3/16                 | 7/16                        | 6             | 8   | 1  | 1/6   |
| 1/4                  | 9/16                        | 9             | 12  | 1  | 1/6   |
| 5/16                 | 5/8                         | 12            | 16  | 1  | 1/6   |
| 3/8                  | 11/16                       | 18            | 24  | 1  | 1/6   |
| 1/2                  | 7/8                         | 34            | 46  | 1  | 1/6   |
| 5/8                  | 1                           | 46            | 62  | 1  | 1/6   |
| 3/4                  | 1-1/4                       | 75            | 102 | 3/4  | 1/8   |
| 7/8                  | 1-3/8                       | 90            | 122 | 3/4  | 1/8   |

\* The torque values shown are based on lubricated connections as in reassembly.

# ENGLISH/METRIC EQUIVALENTS

| ENGLISH                 | FACTOR    | SI UNITS (METRIC)                              |
|-------------------------|-----------|--|
| acres                   | x 0.4047  | = hectares (ha)                                |
| ft/min                  | x 0.3048  | = meters/min (m/min)                           |
| ft/s                    | x 0.3048  | = meters/sec (m/s)                             |
| US gal                  | x 3.7854  | = liters (L)                                   |
| US<br>gal/min<br>(gpm)  | x 3.7854  | = liters/min (L/min)                           |
| hp                      | x 0.7457  | = kilowatts (kW)                               |
| in. <sup>3</sup>        | x 16.3871 | = cubic centimeters (cm <sup>3</sup><br>or cc) |
| lbf                     | x 4.4482  | = newtons (N)                                  |
| lbf·ft or<br>ft·lbf     | x 1.3558  | = newton meters (N·m)                          |
| lbf·in.<br>or<br>in·lbf | x 0.1129  | = newton meters (N·m)                          |
| mph                     | x 1.6063  | = kilometers/hour (km/h)                       |
| oz.                     | x 29.5735 | = milliliters (ml)                             |
| psi                     | x 6.8948  | = kilopascals (kPa)                            |
| psi                     | x .00689  | = megapascals (MPa).                           |



## UNLOADING AND ASSEMBLY

### STEP 1. UNLOAD HEADER



#### CAUTION

To avoid injury to bystanders from being struck by machinery, do not allow persons to stand in unloading area.

#### A. SINGLE FORKLIFT METHOD



#### CAUTION

Equipment used for unloading must meet or exceed the requirements specified below. Using inadequate equipment may result in chain breakage, vehicle tipping or machine damage.

| <b>LIFTING VEHICLE</b> |                     |
|------------------------|---------------------|
| Min. Lifting Capacity  | 9000 lb (4082 kg) * |
| Min. Fork Length       | 78 in. (1981 mm)    |

\* At 48 inches (1220 mm) from back end of of forks.

#### IMPORTANT

Forklifts are normally rated for a load located 24 inches (610 mm) ahead of back end of the forks. To obtain the forklift capacity at 48 inches (1220 mm), check with your forklift distributor.

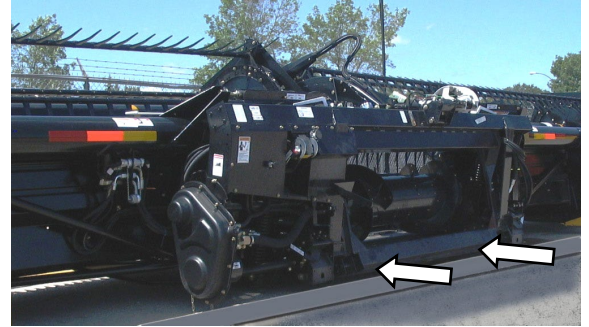

- c. Approach header from its backside and slide forks in underneath adapter lower beam structure as far as possible.
- d. Remove hauler's tie down straps and chains.



#### WARNING

**Be sure forks are secure before moving away from load. Stand clear when lifting.**

- e. Raise windrower off deck.
- f. Back up until unit clears trailer and slowly lower to 6 inches (150 mm) from ground.
- g. Take machine to storage or set-up area.
- h. Place 6 inch (150 mm) blocks under each end of cutterbar.
- i. Lower header onto blocks.
- j. Check for shipping damage and missing parts.



- a. Move trailer into position and block trailer wheels.
- b. Lower trailer storage stands.

## UNLOADING AND ASSEMBLY

### B. COMBINE METHOD

The header is shipped with a fully assembled adapter and will have the necessary frame for attachment to the combine. Ensure the adapter configuration is identified and the appropriate combine is used to pick up the header.

#### NOTE

*A maximum difference of 36 inches (914 mm) (dimension 'X' in illustration) in elevation between a standard or drop-deck truck flatbed and the combine is required for the combine to lift the header off the truck (i.e. using a loading ramp). This may vary with combine make and model.*

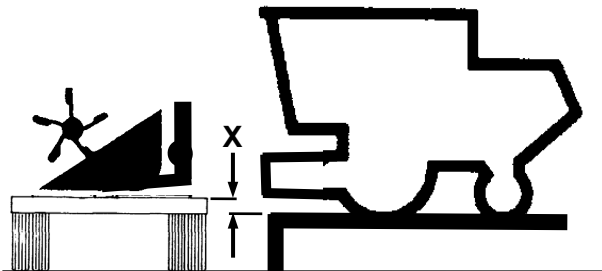

- a. Park the truck next to and at 90 degrees to the ramp, and with the rear of the header on the ramp side. Align the header pick up points approximately with the center of the ramp.
- b. Lower trailer storage stands.
- c. Remove hauler's tie-down straps and chains.
- d. Drive combine onto the ramp and approach header.

#### NOTE

*If a suitable ramp is not available, a ditch or other ground contour can provide the required difference in elevation.*

- e. Pick up header as would normally be done. Refer to STEP 5. ATTACH TO COMBINE in this instruction.

#### NOTE

*The hydraulics and electrical connections are not required to unload the header.*

- f. Raise header off the flatbed and back combine away.
- g. Take machine to storage or set-up area.
- h. Place 6 inch (150 mm) blocks under each end of cutterbar.
- i. Lower header onto blocks.
- j. Detach header from combine.
- k. Check for shipping damage and missing parts.

## UNLOADING AND ASSEMBLY

### C. TWO FORKLIFT METHOD



### CAUTION

Equipment used for unloading must meet or exceed the requirements specified below. Using inadequate equipment may result in chain breakage, vehicle tipping or machine damage.

| <b>LIFTING VEHICLE</b>  |                   |
|-------------------------|-------------------|
| Min. Lifting Capacity * | 5000 lb (2268 kg) |
| Min. Fork Length        | 78 in. (1981 mm)  |

\* At 48 inches (1220 mm) from back end of forks.

### IMPORTANT

Forklifts are normally rated for a load located 24 inches (610 mm) ahead of back end of the forks. To obtain the forklift capacity at 48 inches (1220 mm), check with your forklift distributor.

- a. Position trailer to provide access by forklifts on both sides.

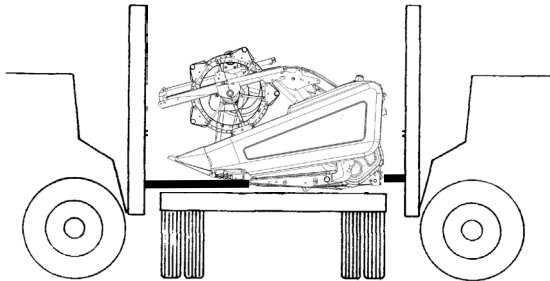

- b. Approach header from both sides.

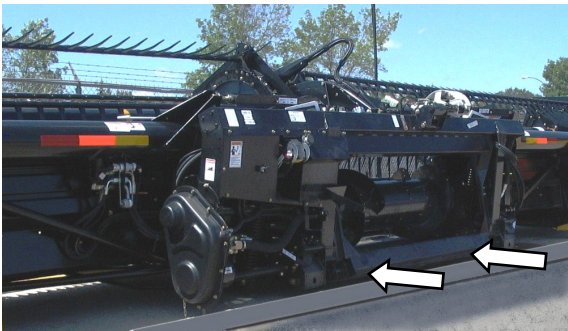

- c. Position forks underneath adapter lower beam structure with one forklift.

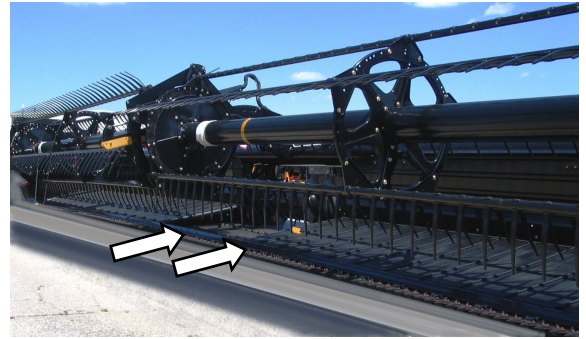

- d. Position forks underneath under cutterbar with other forklift.
- e. Remove hauler's tie down straps and chains.
- f. Slowly raise both forklifts until header clears trailer bed by 4-8 inches (102-204 mm).
- g. Slowly drive truck forward until trailer is clear of header.
- h. Place 6 inch (150 mm) blocks under each end of cutterbar.
- i. Lower header onto blocks.
- j. Back forklifts away from header.
- k. Check for shipping damage and missing parts.

## UNLOADING AND ASSEMBLY

### STEP 2. REPOSITION GEARBOX

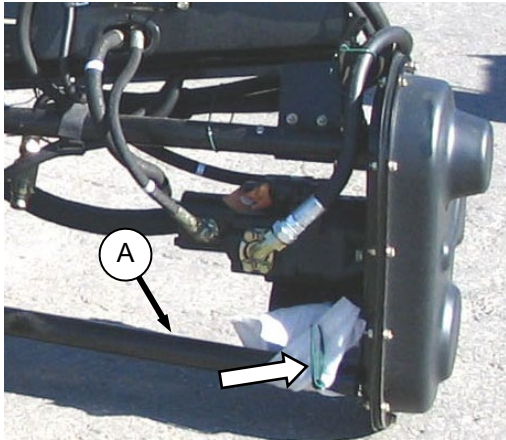

- a. Remove shipping wire and wrapping on brace and swing brace (A) clear of gearbox.



- b. Loosen nut (B) and move bolt out of shipping position slot.

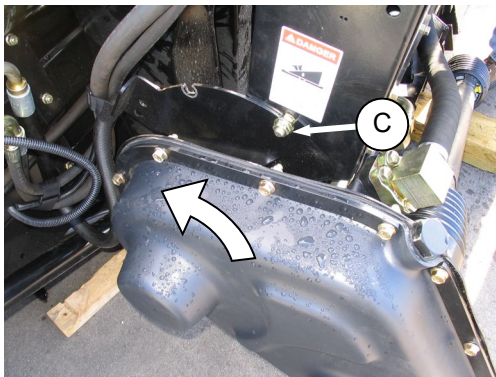

- c. Rotate gearbox and move bolt into working position slot (C). Tighten nut.

- d. Remove bolt and nut from bracket on gearbox.

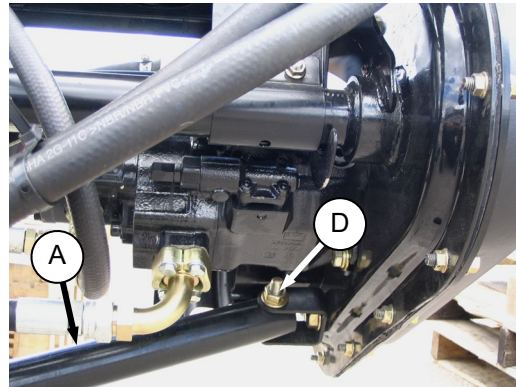

- e. Position brace (A) inside bracket and re-install bolt (D) and nut.

## UNLOADING AND ASSEMBLY

### STEP 3. INSTALL REEL SPEED SENSOR

**NOTE**

*This step is not applicable to CASE/CNH combines. Proceed to STEP 4 INSTALL OPTIONS.*

**IMPORTANT**

Except for Lexion combines, sensors are not supplied with MacDon Combine Adapters having Serial Numbers earlier than 177626\_07. Sensors need to be purchased as per the following:

| COMBINE        | SENSOR PART NO.                           |
|----------------|---|
| JOHN DEERE-ALL | John Deere #AH116104 & Two Nuts #H104418. |
| AGCO-ALL       | AGCO #71 391 021                          |



### CAUTION

To avoid personal injury, before servicing header or opening drive covers:

- Fully lower the header. If necessary to service in the raised position, always engage lift cylinder stops.
- Stop engine and remove key.
- Engage park brake.

#### A. REMOVE COVER

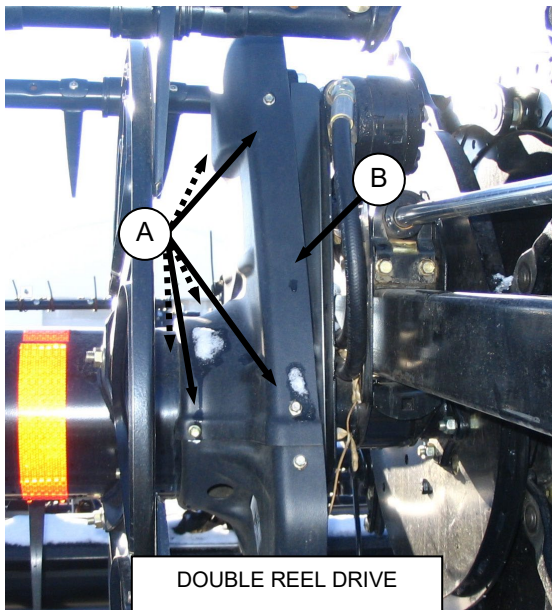

- a. Remove six screws (A) and remove drive upper cover (B).

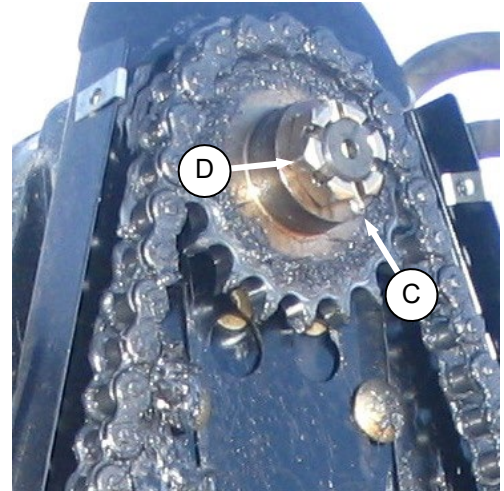

- b. Remove cotter pin (C) and remove slotted nut (D) from drive motor shaft.

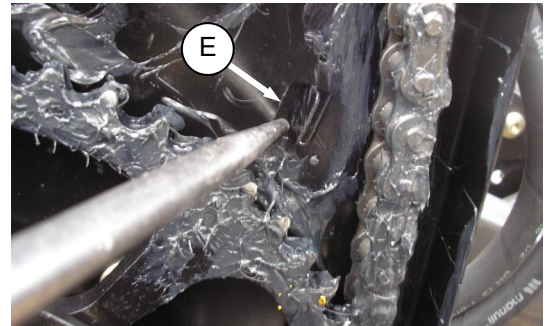

- c. Remove knock-out (E) in chain case for wire harness routing.

**NOTE**

*Clean off grease to expose knock-out.*

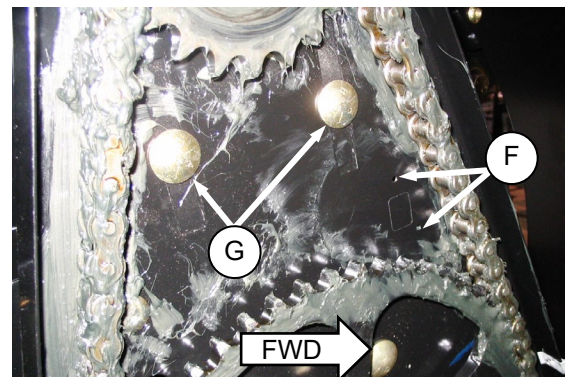

- d. If necessary, clean up holes (FF) with a 0.125 in. (3.2 mm) drill.
- e. Remove bolts (G) in chain case.

*(continued next page)*

## UNLOADING AND ASSEMBLY

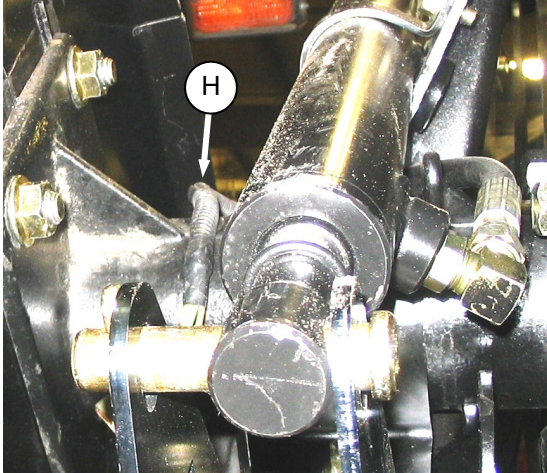

- f. Retrieve existing harness (H) from reel arm.

**NOTE**

*Harness may be stored inside hose cover on top of reel arm.*

- g. Proceed to procedure B, C, D or E for your particular combine.

## UNLOADING AND ASSEMBLY

### B. JOHN DEERE SENSOR INSTALLATION.

- a. Perform A. REMOVE COVER.
- b. Retrieve speed sensor kit from combine completion package.

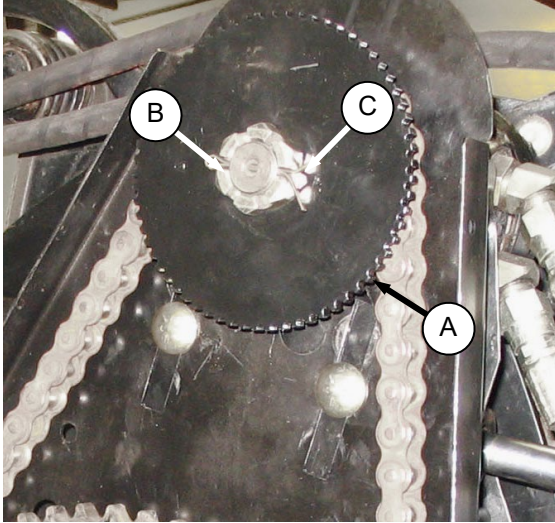

- c. Position speed sensor disc (A) on shaft and re-install slotted nut (B). Torque to 10-20 in·lbf (1.1-2.2 N·m).
- d. Install cotter pin (C). Tighten nut to next slot if required.

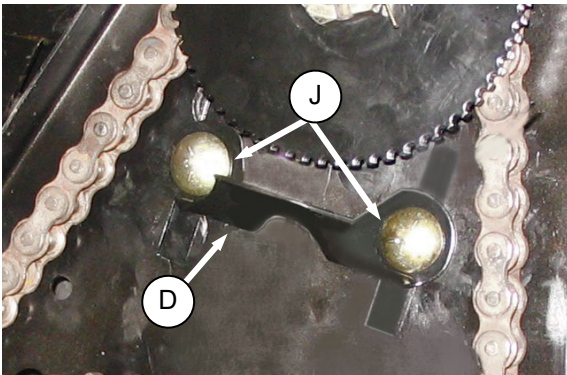

- e. Locate bracket (D) on chain case and re-install bolts (J). Torque to 75 ft·lbf (102 N·m).

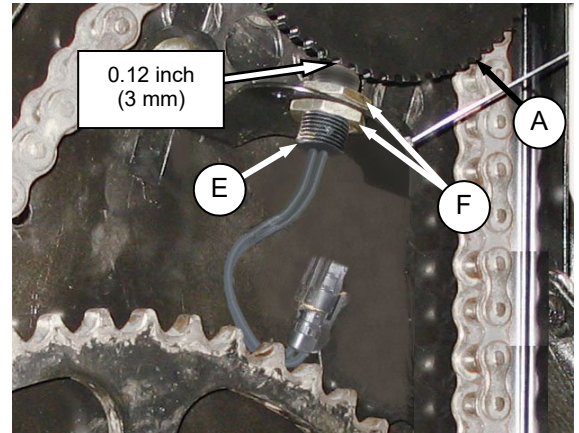

- f. Locate sensor (E) in bracket and adjust gap between sensor and disc (A) to 0.12 in. (3 mm) with nuts (F). Tighten nuts.

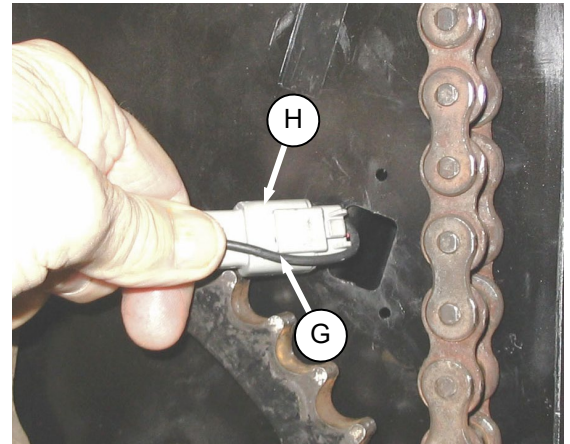

- g. Locate black wire (G) against harness connector (H) as shown and feed connector through hole in chain case.

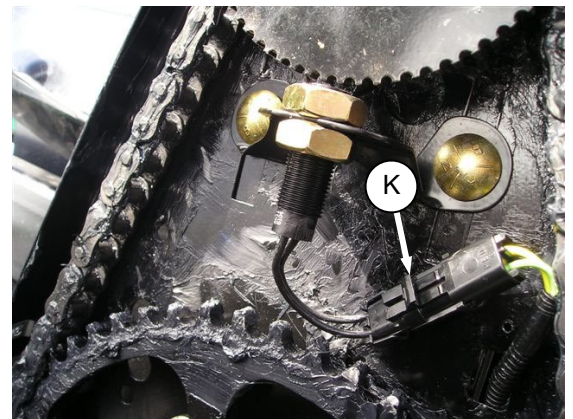

- h. Connect other end to sensor connector (K).

*(continued next page)*

## UNLOADING AND ASSEMBLY

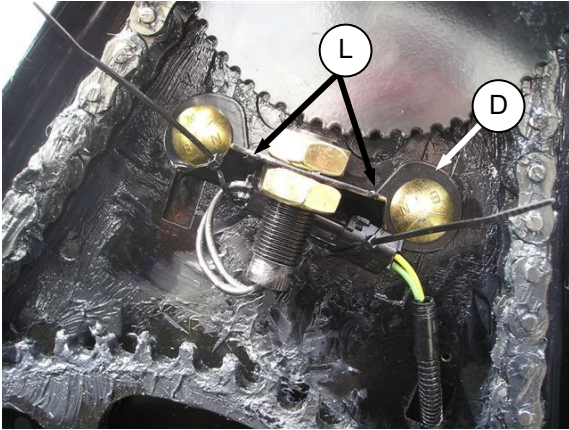

- i. Secure harness to support (D) with two cable ties (L).

### IMPORTANT

Ensure harness is clear of chain and sprockets, and that motor can be moved up and down fully in slots without damaging harness.

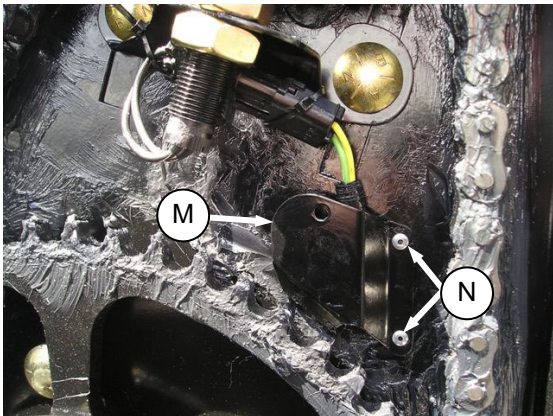

- j. Locate cover (M) over harness and attach to chain case with two rivets (N).
- k. Perform F. INSTALL COVER.



## UNLOADING AND ASSEMBLY

### C. LEXION 500 SERIES SENSOR INSTALLATION

- Perform A. REMOVE COVER.
- Retrieve speed sensor kit from combine completion package.

#### IMPORTANT

The following steps c. and d. are required to establish the amount of slack in the harness, and to determine the harness location on the cover, so that when the chain (A) is loosened, the harness or sensor will not be damaged.

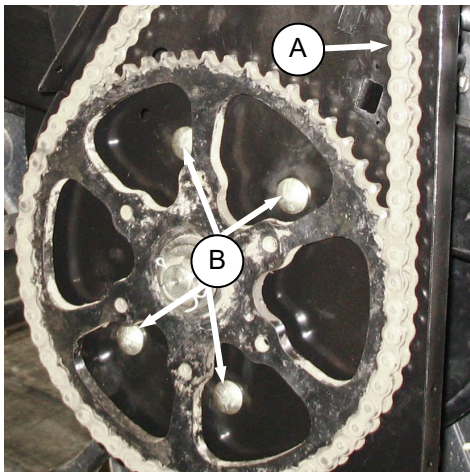

- Loosen drive chain (A) by sliding motor (C) and motor mount (D) down towards reel shaft.

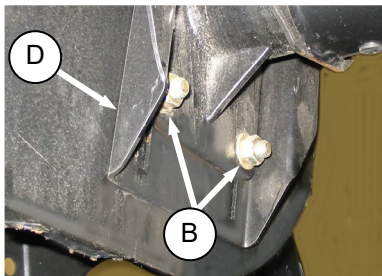
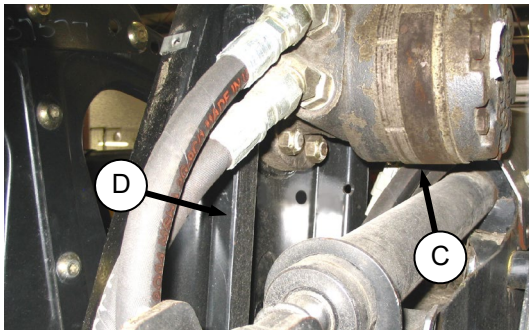

- Loosen drive chain (A) by sliding motor (C) and motor mount (D) down towards reel shaft.

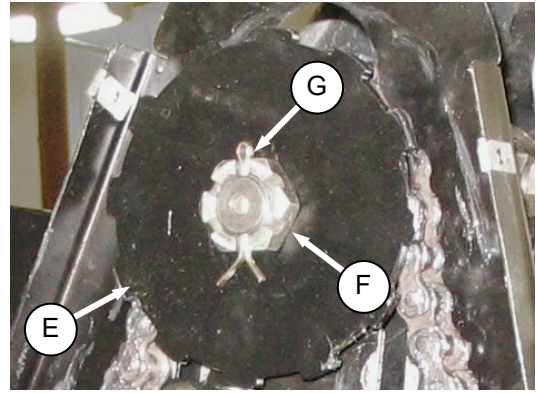

- Position speed sensor disc (E) on shaft and re-install slotted nut (F). Torque to 10-20 in·lbf (1.1-2.2 N·m).
- Install cotter pin (G). Tighten nut to next slot if required.

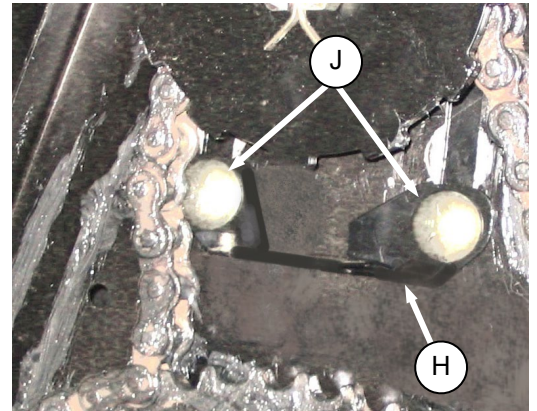

- Locate support (H) on chain case and re-install bolts (J). Torque to 75 ft·lbf (102 N·m).

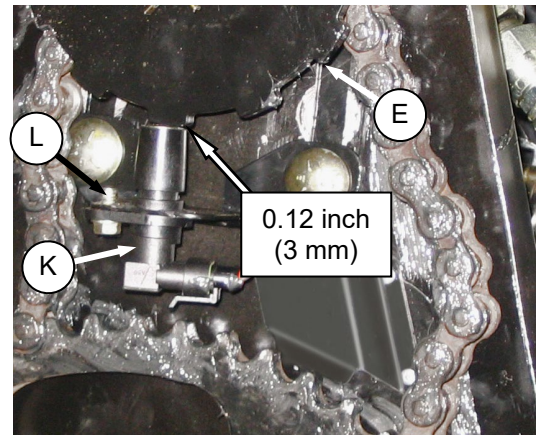

- Locate sensor (K) in support (H) and adjust gap between sensor and disc (E) to 0.12 inch (3 mm) by bending support. After gap is achieved, secure sensor with ¼" x 0.5 self-tapping screw (L).

(continued next page)

## UNLOADING AND ASSEMBLY

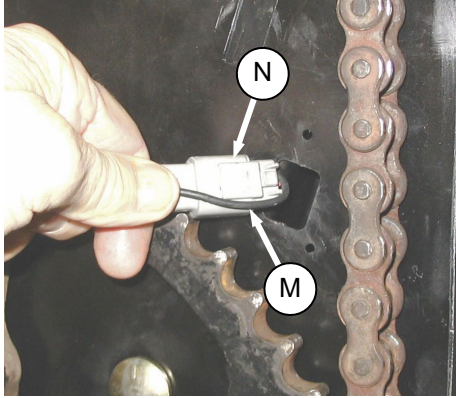

- i. Locate black wire (M) against harness connector (N) as shown and feed connector through hole in chain case.

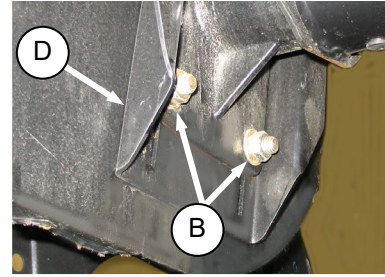
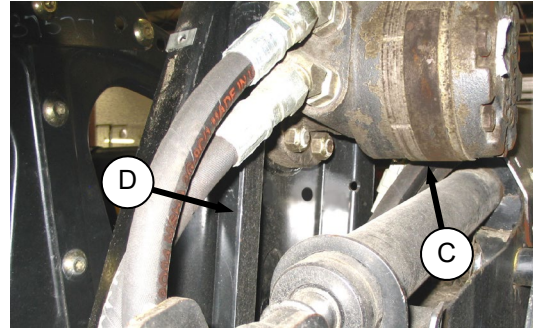

- m. Tighten drive chain by sliding motor (C) and motor mount (D) up away from reel shaft. Hand force should deflect the chain 1/8 inch (3 mm).

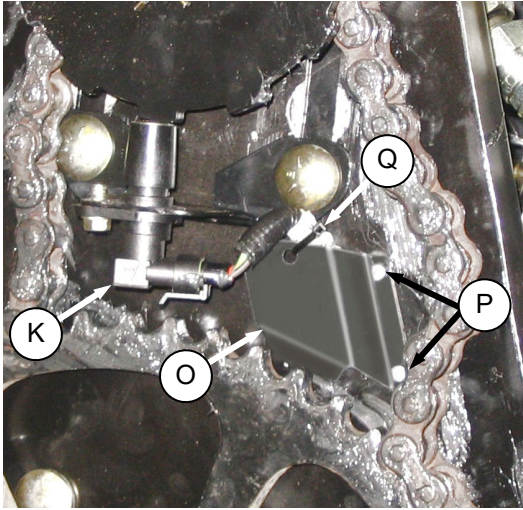

- j. Connect other end to sensor (K).  
 k. Locate cover (O) over harness and attach to chain case with two rivets (P).  
 l. Secure harness to cover (O) with cable tie (Q) exactly as shown.

### IMPORTANT

Ensure harness is clear of chain and sprockets, and that motor can be moved up and down fully in slots without damaging harness.

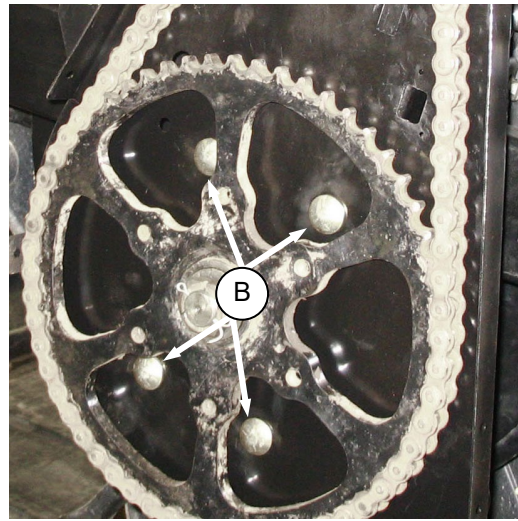

- n. Tighten bolts (B) to 75 ft·lbf (102 N·m).  
 o. Perform F. INSTALL COVER.

## UNLOADING AND ASSEMBLY

### D. LEXION 400 SERIES SENSOR INSTALLATION

- Perform A. REMOVE COVER.
- Retrieve speed sensor kit from combine completion package.

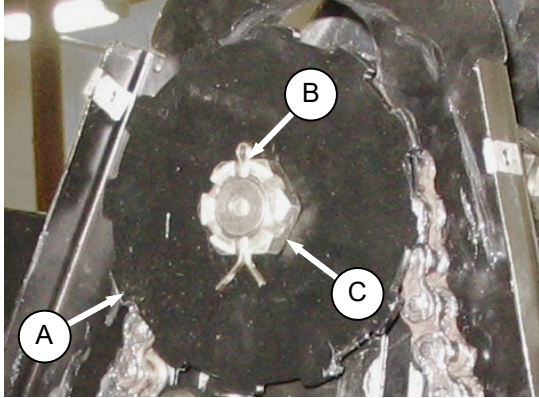

- Position speed sensor disc (A) on shaft and re-install slotted nut (B). Torque to 10-20 in·lbf (1.1-2.2 N·m).
- Install cotter pin (C). Tighten nut to next slot if required.

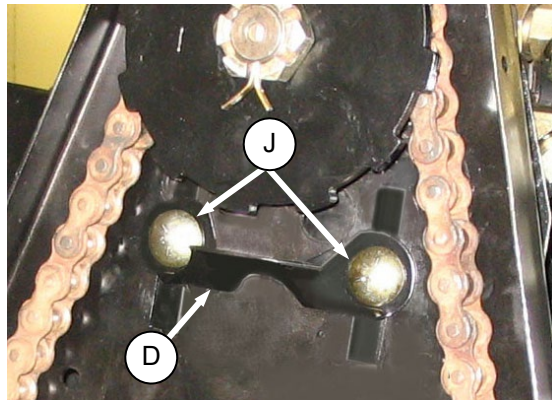

- Locate bracket (D) on chain case and re-install bolts (J). Torque to 75 ft·lbf (102 N·m).

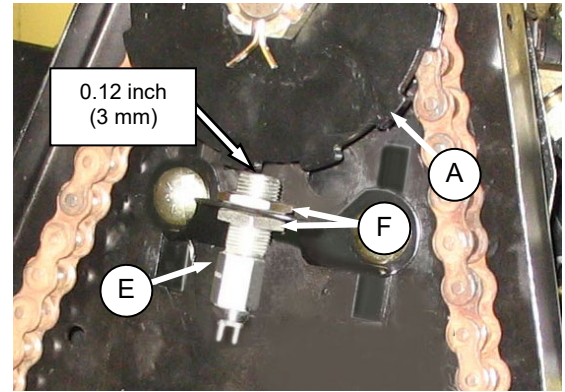

- Locate sensor (E) in bracket and adjust gap between sensor and disc (A) to 0.12 inch (3 mm) with nuts (F). Tighten nuts.

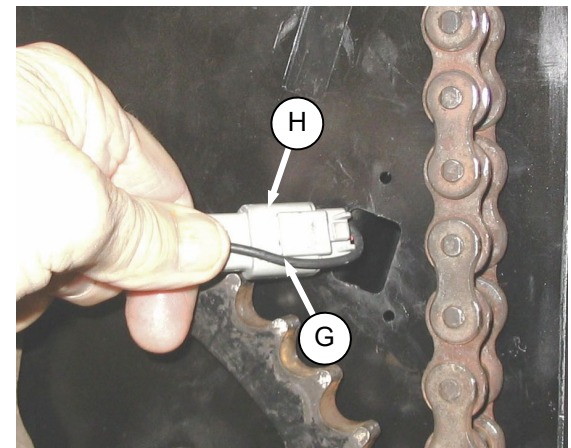

- Locate black wire (G) against harness connector (H) as shown and feed connector through hole in chain case.

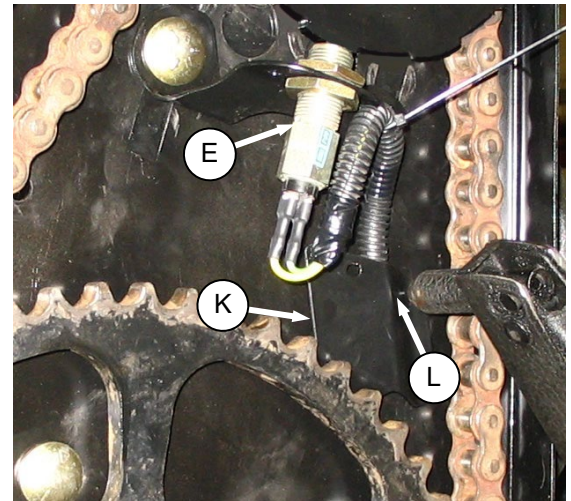

- Connect other end to sensor (E).
- Locate cover (K) over harness and attach to chain case with two rivets (L).

(continued next page)

## UNLOADING AND ASSEMBLY

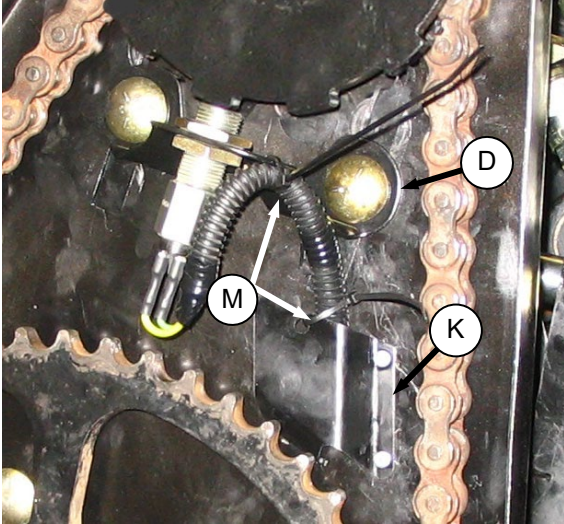

- j. Secure harness to support (D) and cover (K) with cable ties (M).

### **IMPORTANT**

Ensure harness is clear of chain and sprockets, and that motor can be moved up and down fully in slots without damaging harness.

- k. Perform F. INSTALL COVER.

## UNLOADING AND ASSEMBLY

### E. AGCO SENSOR INSTALLATION

- Perform A. REMOVE COVER.
- Retrieve speed sensor kit from combine completion package.

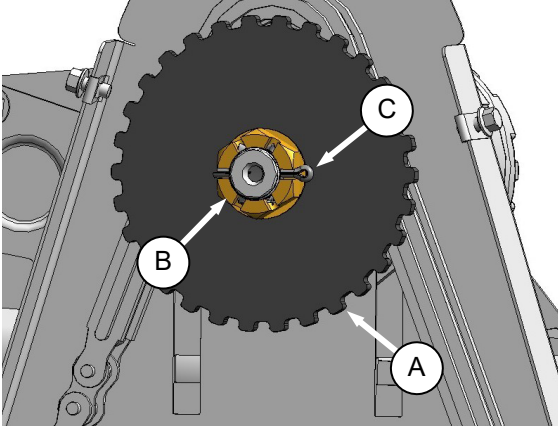

- Position speed sensor disc (A) on shaft and re-install slotted nut (B). Torque to 10-20 in·lbf (1.1-2.2 N·m).
- Install cotter pin (C). Tighten nut to next slot if required.

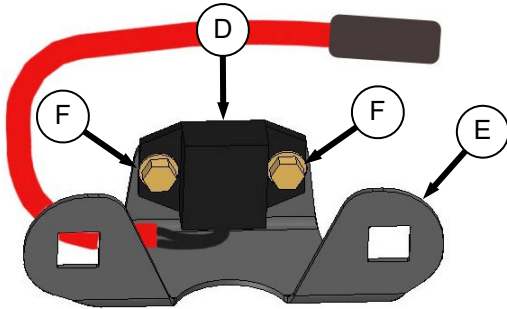

- Assemble sensor (D) to support (E) with self-tapping screws (F).

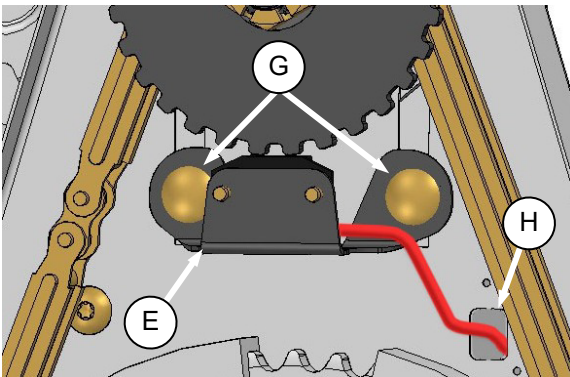

- Locate support (E) on chain case and re-install bolts (G). Torque to 75 ft·lbf (102 N·m).

- Route connector end of sensor harness through hole (H) in drive case as shown.

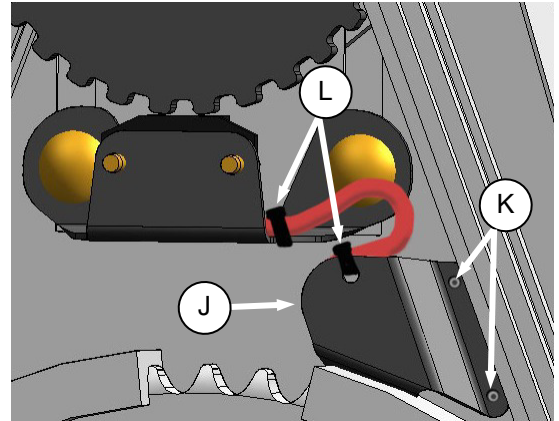

- Locate cover (J) over harness and attach to chain case with two rivets (K).
- Secure harness to cover (K) and support with cable ties (L) exactly as shown.

#### IMPORTANT

Ensure harness is clear of chain and sprockets, and that motor can be moved up and down fully in slots without damaging harness.

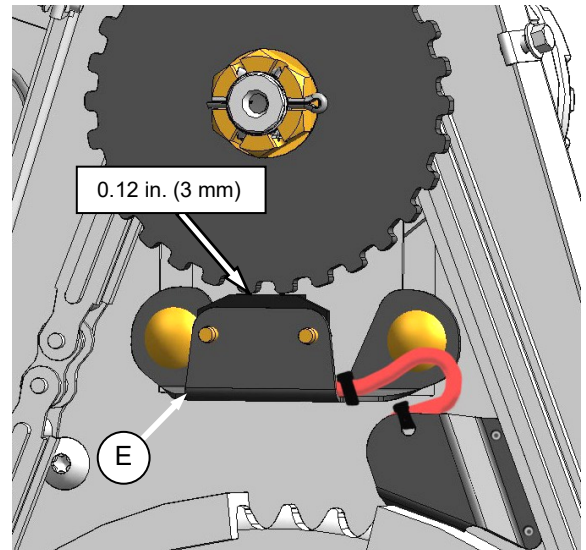

- Adjust gap between sensor and disc to 0.12 inch (3 mm) by bending support (E).

## UNLOADING AND ASSEMBLY

### F. INSTALL COVER

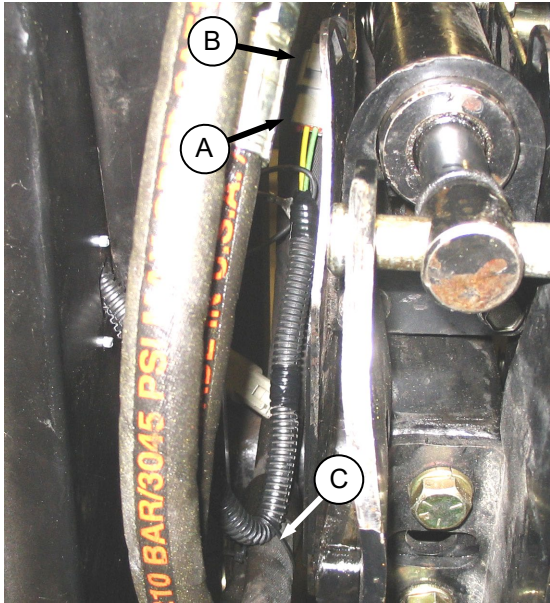

- a. Attach sensor connector (A) to existing harness (B) behind chain case.
- b. Secure sensor harness to hose with cable tie (C).

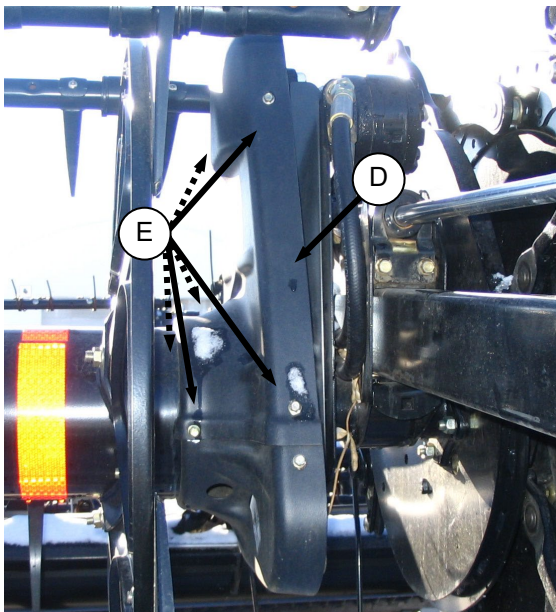

- c. Position cover (D) and install six screws (E).

### STEP 4. INSTALL OPTIONS

Retrieve kits supplied as options with the header and install in accordance with installation instructions supplied in each kit.

## UNLOADING AND ASSEMBLY

### STEP 5. ATTACH TO COMBINE

Refer to specific section for your combine.

|                      |           |
|----------------------|-----------|
| CASE NEW HOLLAND     | SECTION A |
| JOHN DEERE 60 SERIES | SECTION B |
| JOHN DEERE 50 SERIES | SECTION C |
| LEXION               | SECTION D |
| AGCO                 | SECTION E |

#### IMPORTANT

Ensure applicable functions (AHHC, Draper Header Option, Hydraulic Center Link Option, Hydraulic Reel Drive, etc.) are enabled on the combine and combine computer. Failure to do so may result in improper header operation.

#### A. CASE NEW HOLLAND

Case 7010, 8010, New Holland CX

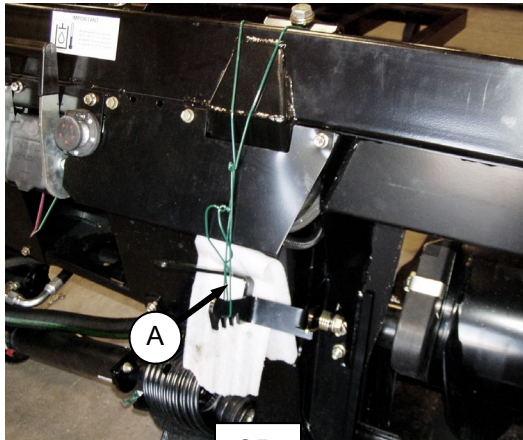

OR

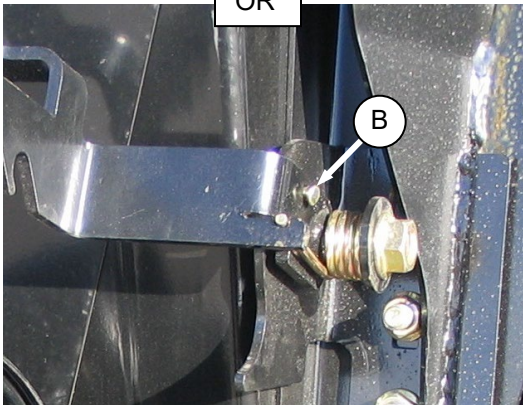

- Remove shipping wire attaching latch (A) to adapter frame, OR remove shipping pin (B). Retain pin for future installation.

- Slowly drive combine up to header until feeder house saddle (C) is directly under the adapter top cross member (D).
- Raise feeder house to lift header slightly, ensuring feeder saddle is properly engaged in adapter frame.

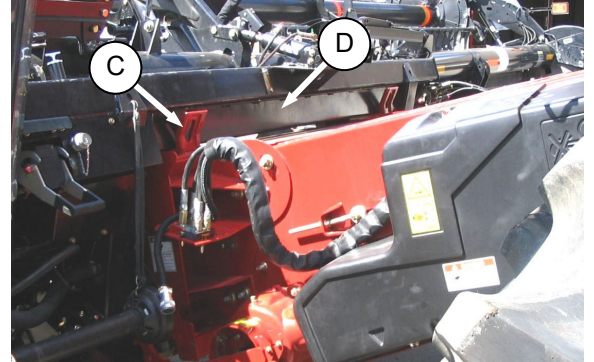

#### CAUTION

Stop engine and remove key from ignition before leaving operator's seat for any reason. A child or even a pet could engage an idling machine.

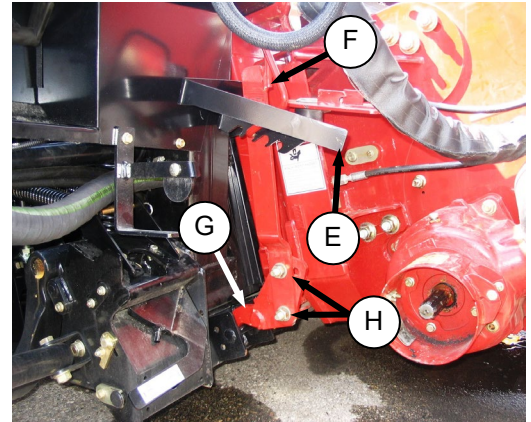

- Lift latch (E) on adapter at left side of feeder house and push handle (F) on combine to engage locks (G) on both sides of the feeder house.
- Push down on latch (E) so that slot in latch engages handle (F) to lock it in place.
- If lock (G) does not fully engage pin on adapter when latch (E) and handle (F) are engaged, loosen bolts (H) and adjust lock as required. Re-tighten bolts.
- Remove blocks from under cutterbar.
- Start engine and lower header. Shutdown combine.

*(continued next page)*

## UNLOADING AND ASSEMBLY

- i. Connect combine hydraulic quick coupler to receptacle on adapter as follows:

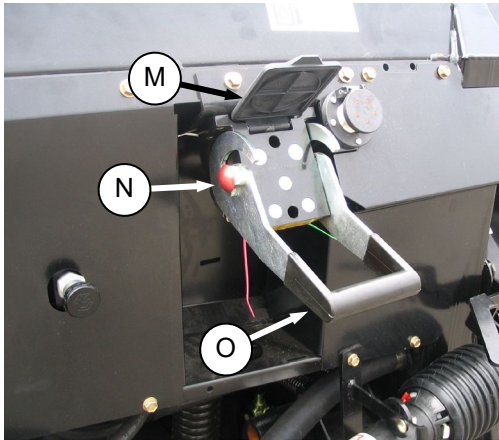

1. Open cover (M).
2. Push in lock button (N) and pull handle (O) to position approximately as shown.

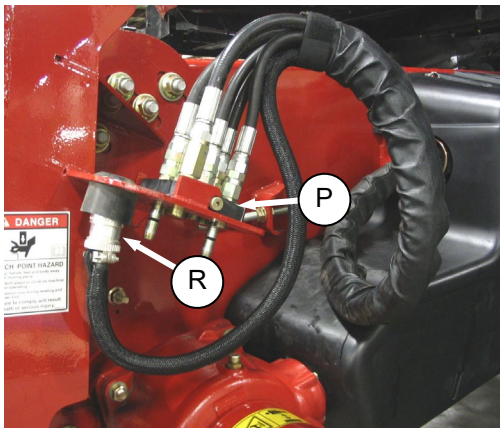

3. Remove coupler (P) from combine and clean coupler.

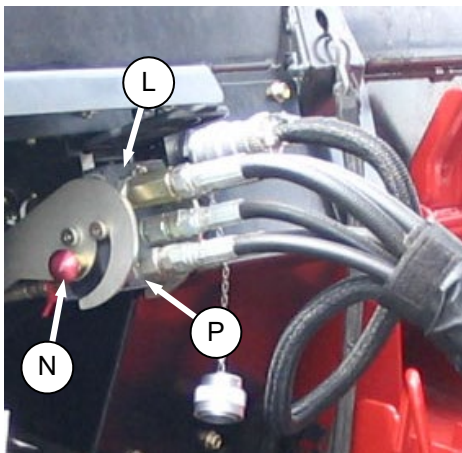

4. Position coupler (P) onto receptacle (L) and push handle to engage coupler pins into receptacle.

5. Push handle to closed position until lock button (N) snaps out.

- j. Connect combine electrical cable to adapter as follows:

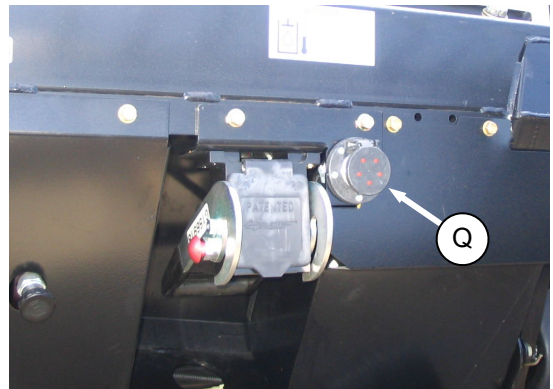

1. Open cover on adapter electrical receptacle (Q).
2. Remove electrical connector (R) from storage cup on combine.

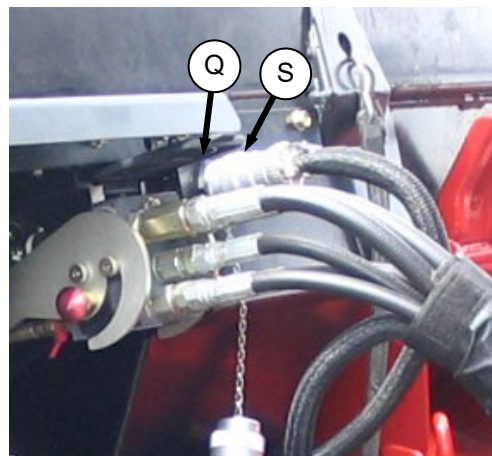

3. Align lugs on connector (S) with slots in adapter receptacle (Q), push connector onto receptacle and turn collar on connector to lock it in place.

*(continued next page)*



## UNLOADING AND ASSEMBLY

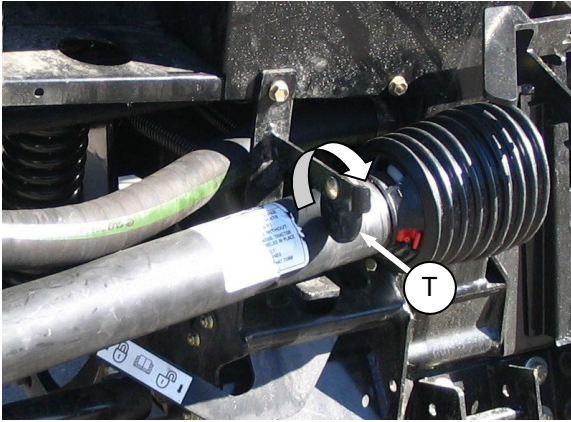

- k. Rotate disc (T) on adapter drive-line storage hook and remove drive-line from hook.

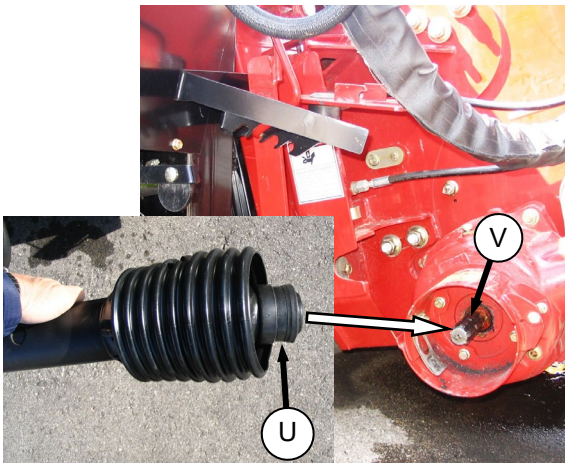

- l. Pull back collar (U) on end of drive line and push onto combine output shaft (V) until collar locks.
- m. Proceed to STEP 6. REMOVE SHIPPING SUPPORTS (page 34).

## UNLOADING AND ASSEMBLY

### B. JOHN DEERE 60 SERIES

Models Contour Master, Level Land.

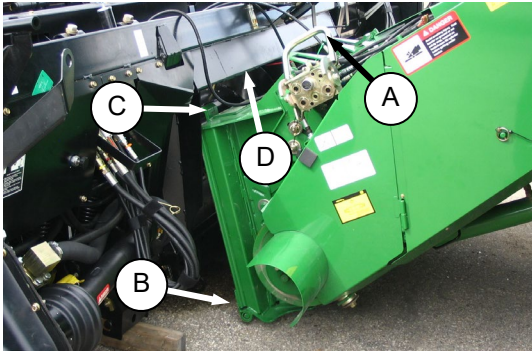

- Push handle (A) on combine coupler toward feeder house to retract pins (B) at bottom corners of feeder house.
- Slowly drive combine up to adapter until feeder house saddle (C) is directly under the adapter top cross member (D).
- Raise feeder house to lift adapter, ensuring feeder saddle is properly engaged in adapter frame.
- Position header slightly off the ground.



### CAUTION

Stop engine and remove key from ignition before leaving operator's seat for any reason. A child or even a pet could engage an idling machine.

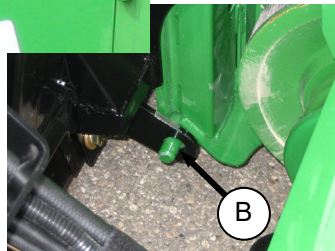
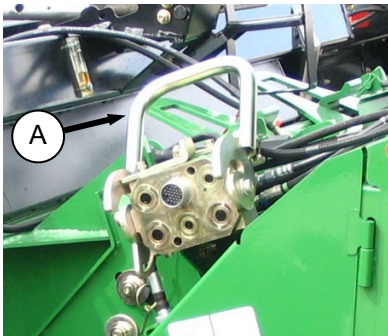

- Pull handle (A) to engage pins (B) in adapter.

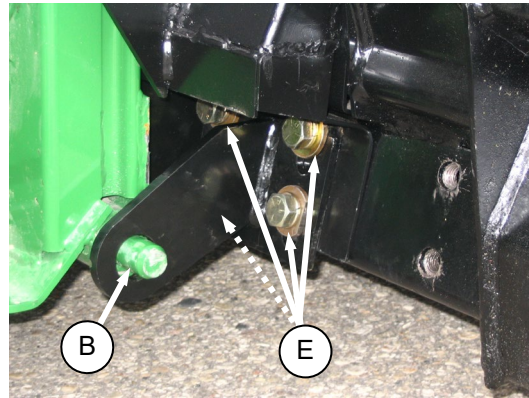

- Check that bolts (E) on adapter brackets are tight.
- If pins (B) do not fully engage adapter brackets, loosen bolts (E) and adjust bracket as required. Re-tighten bolts.
- Remove blocks from under cutterbar.
- Start engine and lower header.

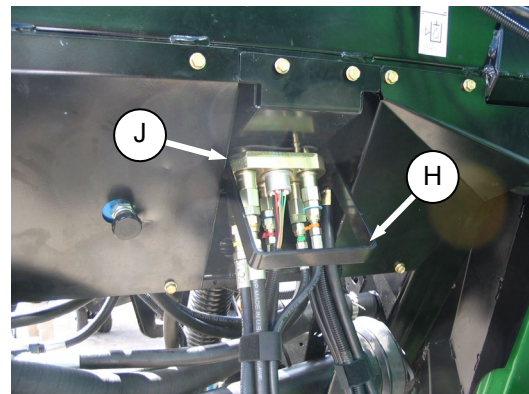

- Pull handle (H) on adapter to release coupler (J) from storage position. Remove coupler and push handle back into adapter to store.

*(continued next page)*

## UNLOADING AND ASSEMBLY

### JOHN DEERE 60 SERIES (Cont'd)

k. Attach coupler (J) to combine as follows:

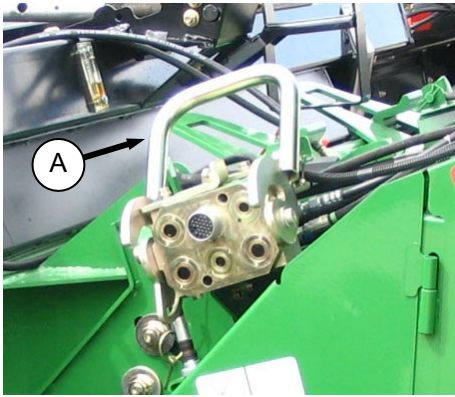

1. Handle (A) should be in the nearly up position. Clean receptacle.

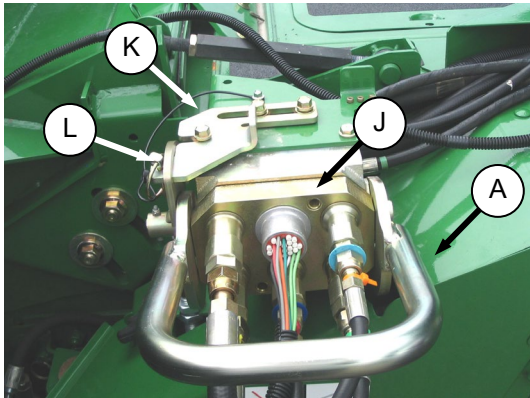

2. Locate coupler (J) onto receptacle and pull handle (A) so that lugs on coupler are engaged into handle.
3. Pull handle to full horizontal position as shown.
4. Slide latch (K) to lock handle in position and secure with lynch pin (L).

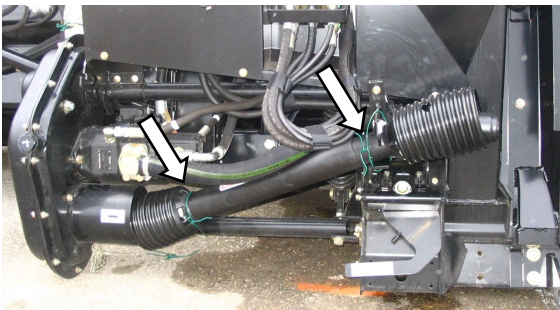

l. Remove shipping wire from driveline.

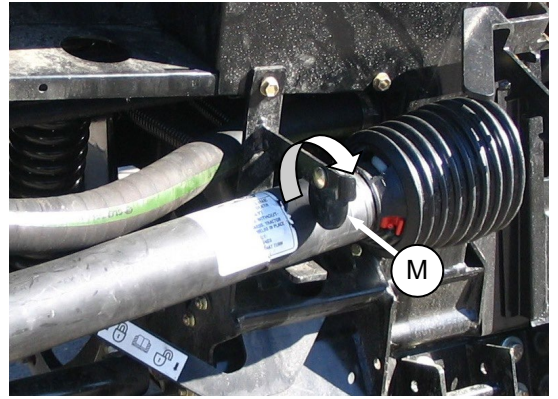

- m. Rotate disc (M) on adapter drive-line storage hook and remove drive-line from hook.

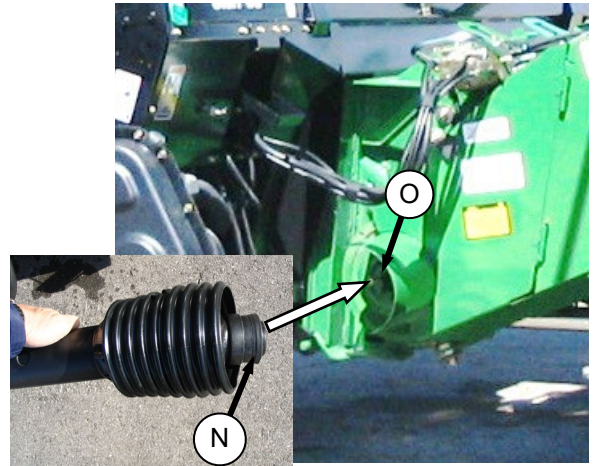

- n. Pull back collar (N) on end of drive line and push onto combine output shaft (O) until collar locks.

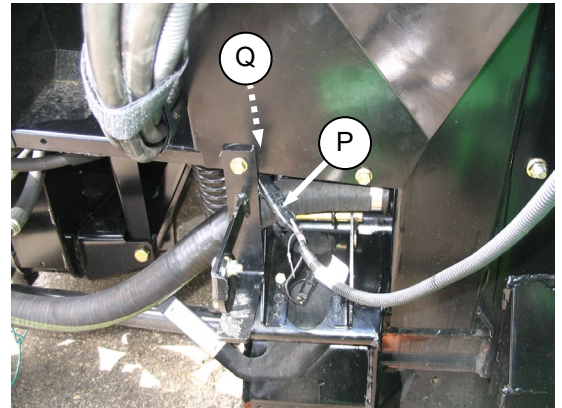

- o. If adapter is equipped with reel fore-aft/header tilt selector, connect harness (P) to combine.

#### NOTE

Connector (P) may need to be retrieved from hydraulics compartment access hole (Q).

- p. Proceed to STEP 6. REMOVE SHIPPING SUPPORTS (page 34).

## UNLOADING AND ASSEMBLY

### C. JOHN DEERE 50 SERIES

Models Contour Master, Level Land.

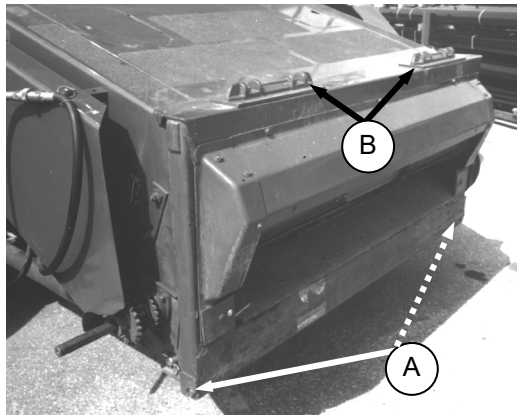

- a. Retract pins (A) at bottom corners of feeder house.

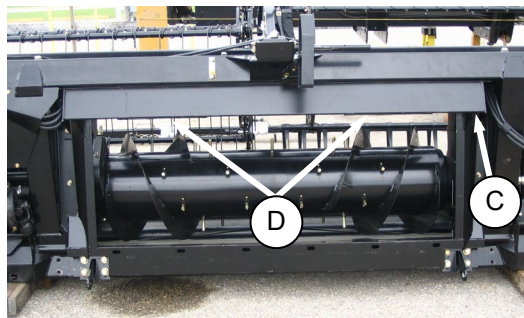

- b. Slowly drive combine up to adapter until feeder house lift lugs (B) are directly under the adapter top cross member (C).
- c. Raise feeder house to lift adapter, ensuring lift lugs (B) are properly engaged in adapter frame sockets (D).
- d. Position header slightly off the ground.



### CAUTION

Stop engine and remove key from ignition before leaving operator's seat for any reason. A child or even a pet could engage an idling machine.

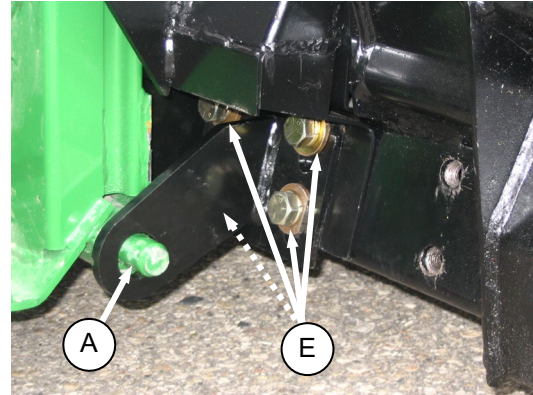

- e. Engage pins (A) in adapter.
- f. Check that bolts (E) on adapter brackets are tight.
- g. If pins (A) do not fully engage adapter brackets, loosen bolts (E) and adjust bracket as required. Re-tighten bolts.
- h. If required, remove blocks from under cutterbar.
- i. Start engine and lower header.
- j. At left side of combine feeder house, retrieve reel aft hose, reel lift hose and electrical harness.

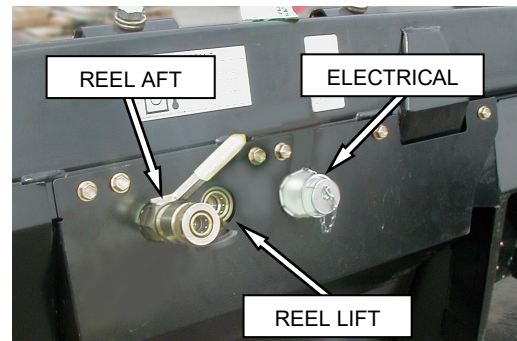

- k. Clean couplers and attach as shown above.
- l. At right side of feeder house, disconnect reel drive hoses and retrieve reel fore hose.

*(continued next page)*

## UNLOADING AND ASSEMBLY

### JOHN DEERE 50 SERIES (Cont'd)

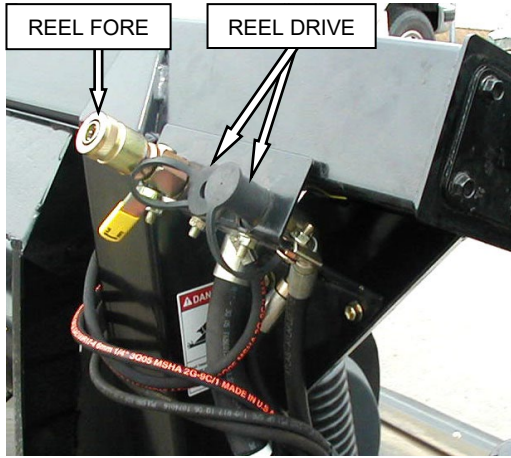

m. Clean couplers and attach as shown above.

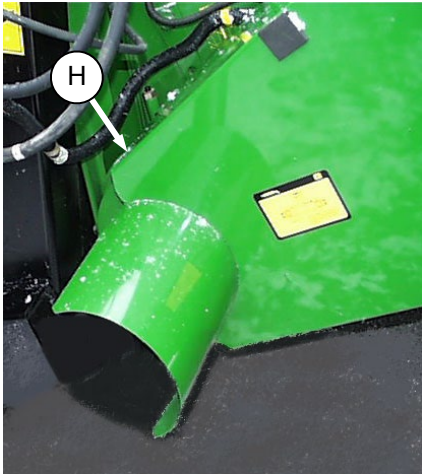

n. Open shield (H) on combine.

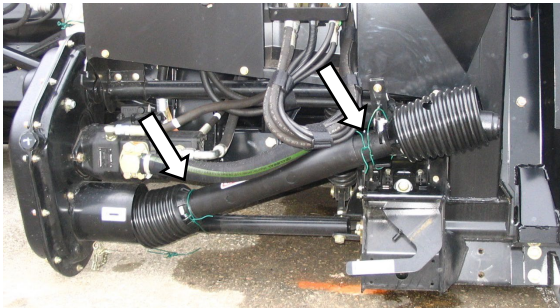

o. Remove shipping wire securing driveline to adapter.

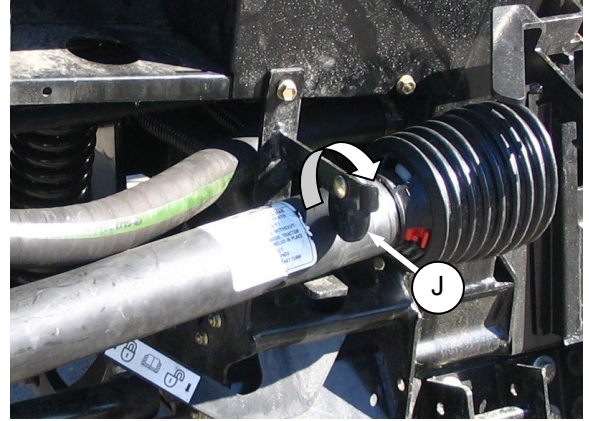

p. Rotate disc (J) on adapter drive-line storage hook and remove drive-line from hook.

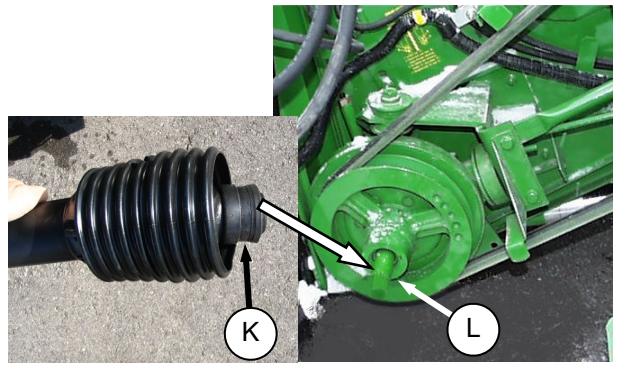

q. Pull back collar (K) on end of drive line and push onto combine output shaft (L) until collar locks.

r. Close drive shield (H) on combine.

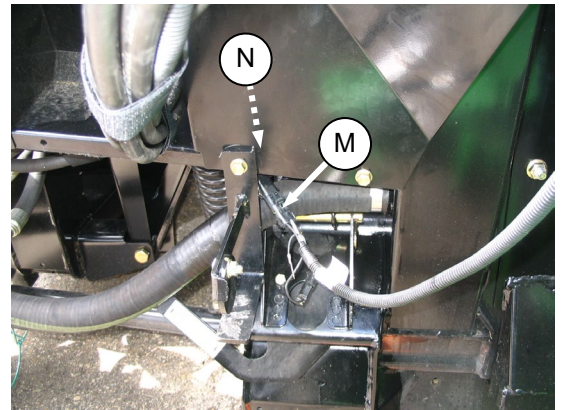

s. If adapter is equipped with reel fore-aft/header tilt selector, connect harness (M) to combine.

#### NOTE

*Connector (M) may need to be retrieved from hydraulics compartment access hole (N).*

t. Proceed to STEP 6. REMOVE SHIPPING SUPPORTS (page 34).

## UNLOADING AND ASSEMBLY

### D. LEXION

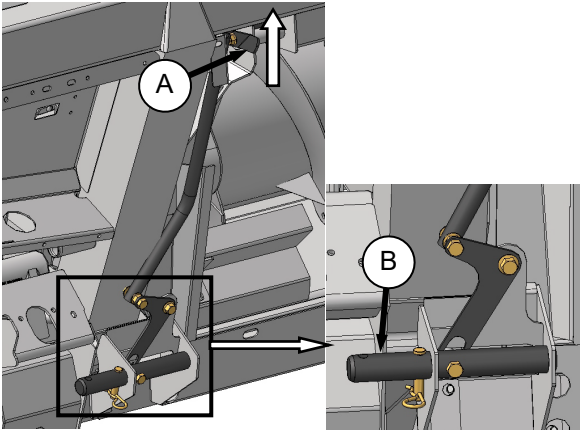

- Handle (A) on the CA20 adapter should be in raised position and pins (B) at bottom corners of adapter retracted.
- Slowly drive combine up to header until feeder house is directly under the adapter top cross member.

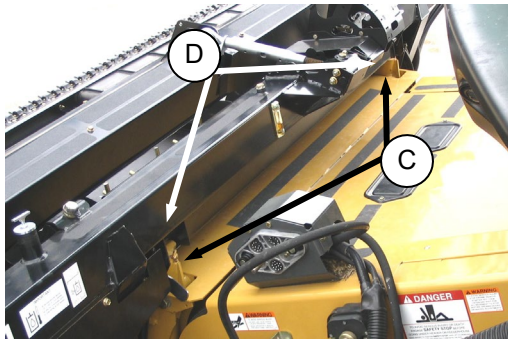

- Raise feeder house to lift adapter, ensuring feeder house posts (C) are properly engaged in adapter frame (D).
- Position header slightly off the ground.



### CAUTION

Stop engine and remove key from ignition before leaving operator's seat for any reason. A child or even a pet could engage an idling machine.

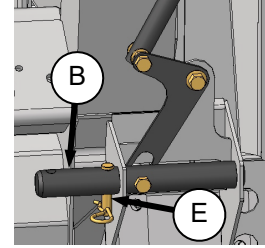

- Remove locking pin (E) from adapter pin (B).

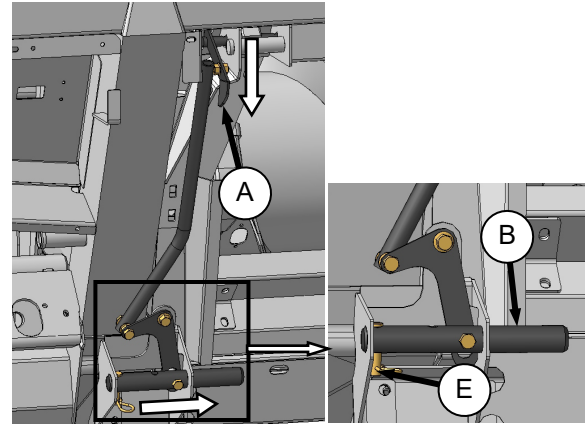

- Lower handle (A) to engage adapter pins into feeder house. Re-insert locking pin (E) and secure with hairpin.
- Remove blocks from under cutterbar.
- Start engine and lower header. Shut down the combine.

*(continued next page)*

# UNLOADING AND ASSEMBLY

## LEXION (Cont'd)

i. Connect hydraulic hoses as follows:

### 500 Series

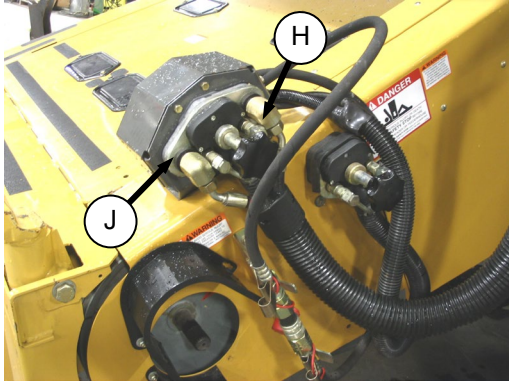

1. Unscrew knob (H) on combine coupler (J) to release coupler from combine receptacle.

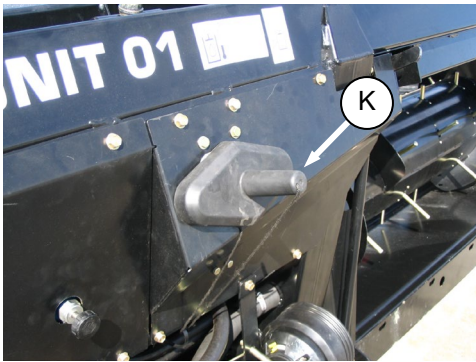

2. Remove cover (K) from adapter receptacle.

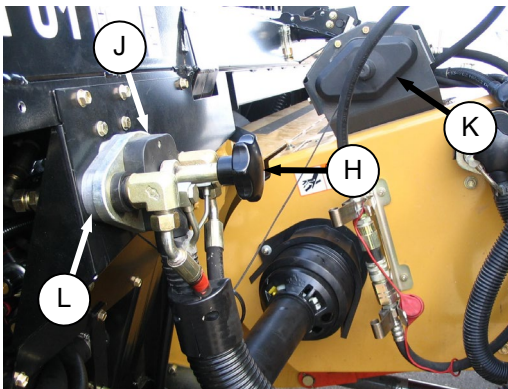

3. Locate coupler (J) onto adapter receptacle (L) and turn knob (H) to secure coupler to receptacle.
4. Place cover (K) on combine receptacle.
5. Proceed to step j.

### 400 Series

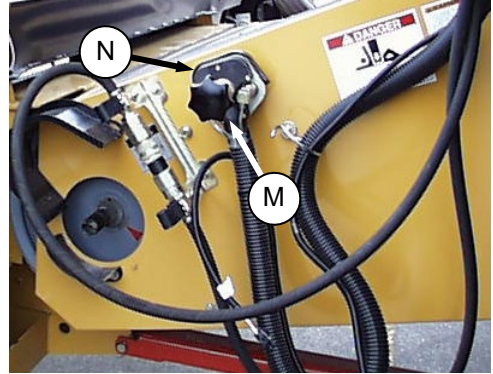

1. Unscrew knob (M) on combine coupler (N) to release coupler from combine receptacle.

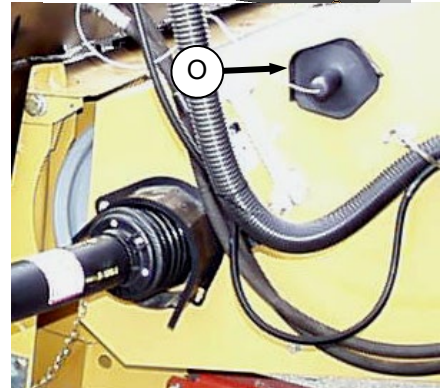
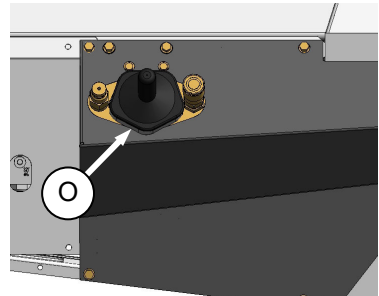

2. Remove cover (O) from adapter receptacle and place on combine receptacle.

*(continued next page)*

## UNLOADING AND ASSEMBLY

### LEXION (Cont'd)

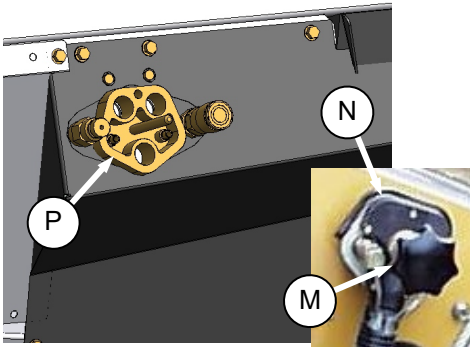

3. Locate coupler (N) onto adapter receptacle (P) and turn knob (M) to secure coupler to receptacle.

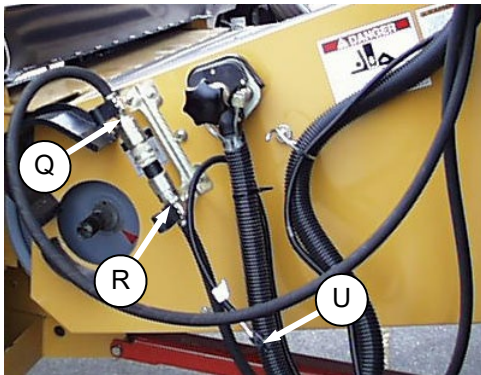

4. Disconnect hoses (Q) and (R) on combine at couplers.

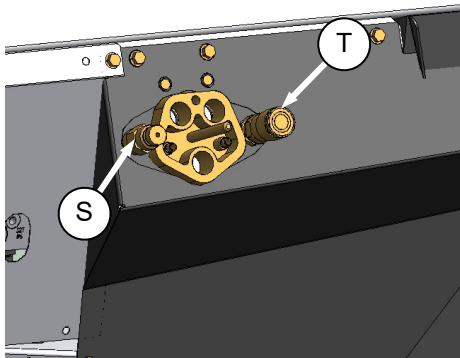

5. Connect hose (Q) to coupler (S) on adapter.
6. Connect hose (R) to coupler (T) on adapter.
7. Connect wiring harness (U) to adapter connector (not shown).

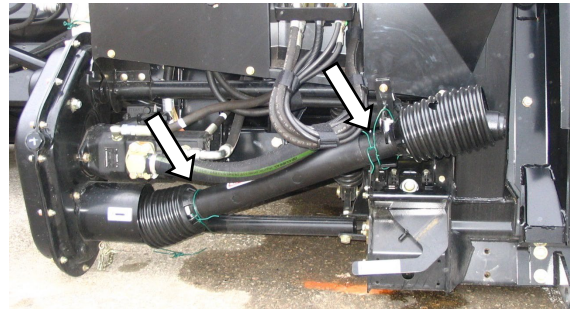

- j. Remove shipping wire securing driveline to adapter.

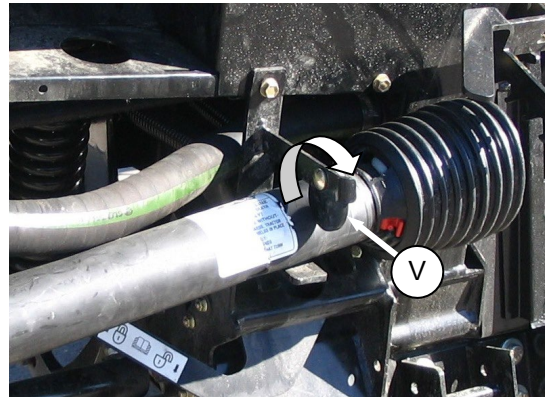

- k. Rotate disc (V) on adapter drive-line storage hook and remove drive-line from hook.

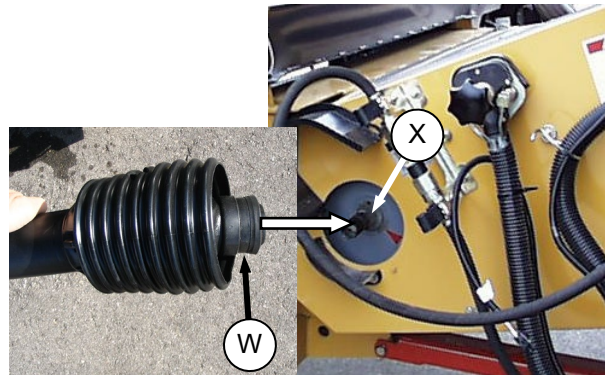

- l. Pull back collar (W) on end of drive line and push onto combine output shaft (X) until collar locks.

*(continued next page)*



## UNLOADING AND ASSEMBLY

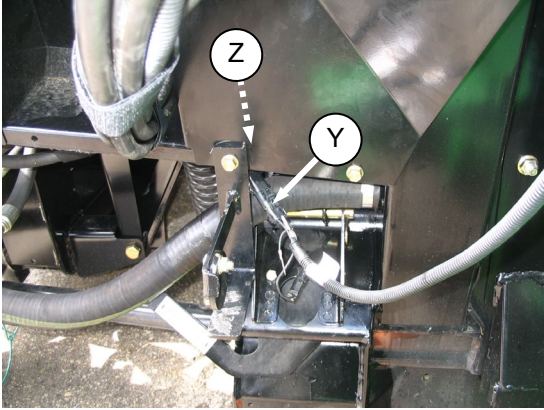

- m. If adapter is equipped with reel fore-aft/header tilt selector, connect harness (Y) to combine.

**NOTE**

*Connector (Y) may need to be retrieved from hydraulics compartment access hole (Z).*

- n. Proceed to STEP 6. REMOVE SHIPPING SUPPORTS (page 34).

## UNLOADING AND ASSEMBLY

### E. AGCO

Gleaner R Series and A Series  
Challenger 660, 670, and 680B  
Massey 9690, 9790, and 9895

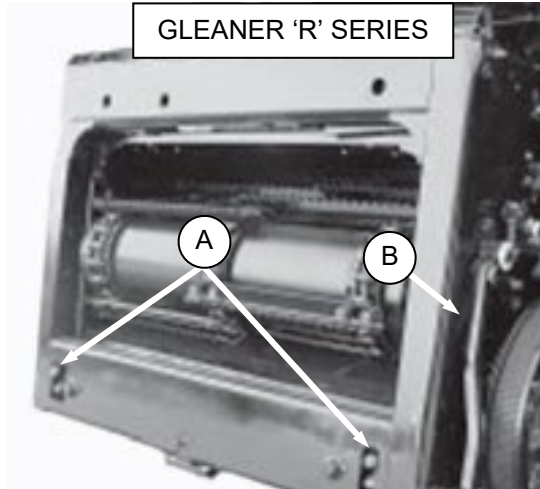

- a. Retract lugs (A) at base of feeder-house with lock handle (B).

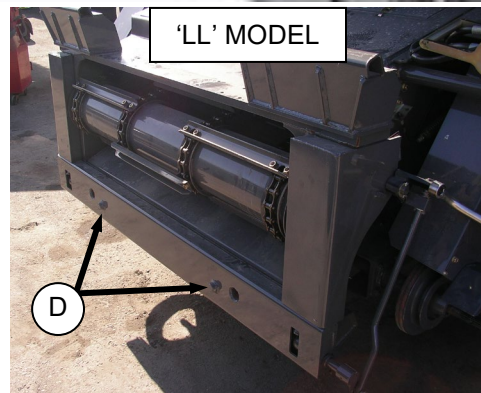
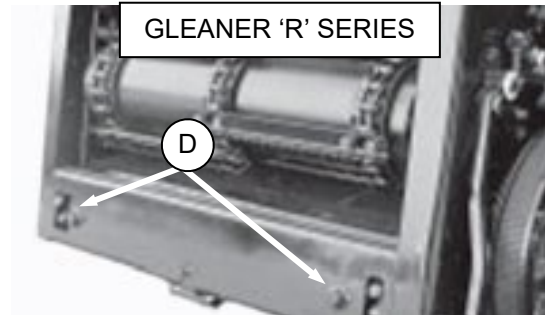
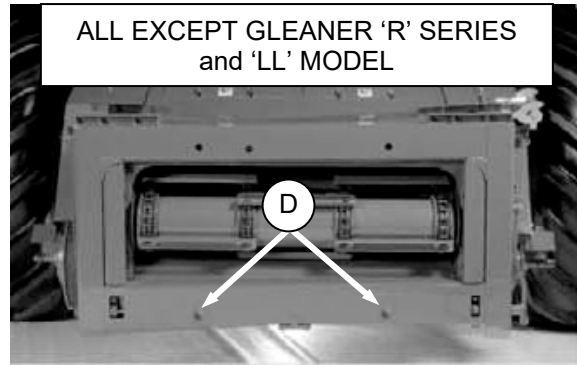

- b. Slowly drive combine up to adapter until feeder house is directly under the adapter top cross member (C) and alignment pins (D) are aligned with holes (E) in adapter frame.

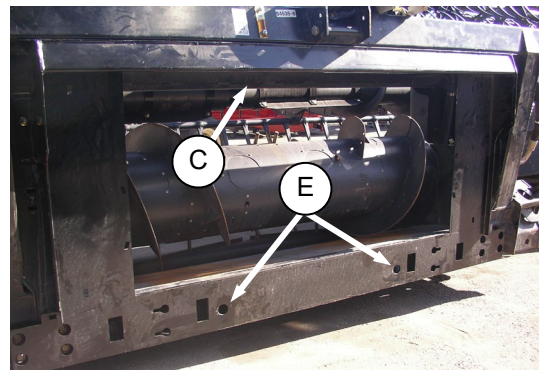

*(continued next page)*

## UNLOADING AND ASSEMBLY

### AGCO (Cont'd)

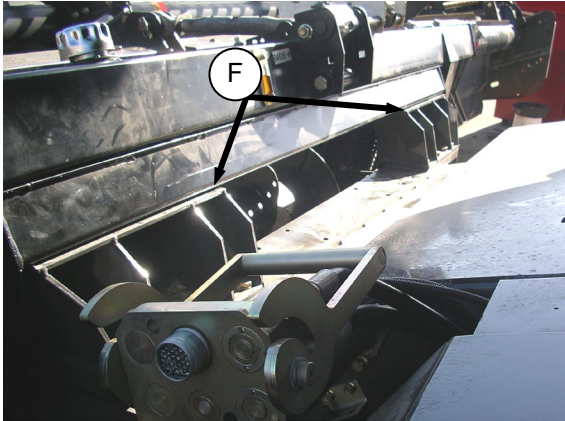

- c. Raise feeder house to lift adapter, ensuring feeder house saddle (F) and alignment pins are properly engaged in adapter frame.
- d. Position header slightly off the ground.



### CAUTION

**Stop engine and remove key from ignition before leaving operator's seat for any reason. A child or even a pet could engage an idling machine.**

ALL EXCEPT GLEANER 'R' SERIES

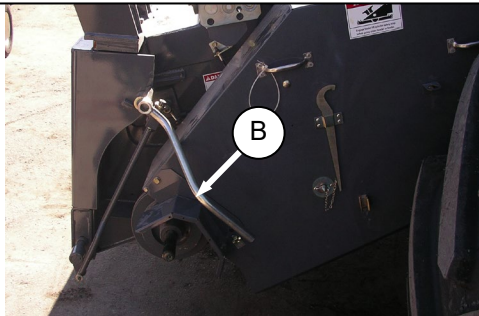

GLEANER 'R' SERIES

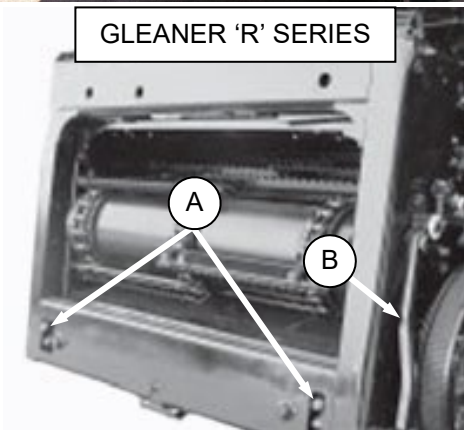

- e. Engage lugs (A) with adapter using lock handle (B).

- f. Remove blocks from under cutterbar.
- g. Start engine and lower header. Shut down the combine.

#### NOTE

*The CA20 Combine Adapter is equipped with a multi-coupler that connects to the combine. If your combine is equipped with individual connectors, a multi-coupler kit (single-point connector) must be installed. The kits are available through your AGCO dealer and include installation instructions.*

| COMBINE            | AGCO KIT # |
|--------------------|------------|
| Challenger         | 71530662   |
| Massey             | 71411594   |
| Gleaner 'R' Series | 71414706   |

- h. Connect adapter hydraulic quick coupler to combine receptacle as follows:

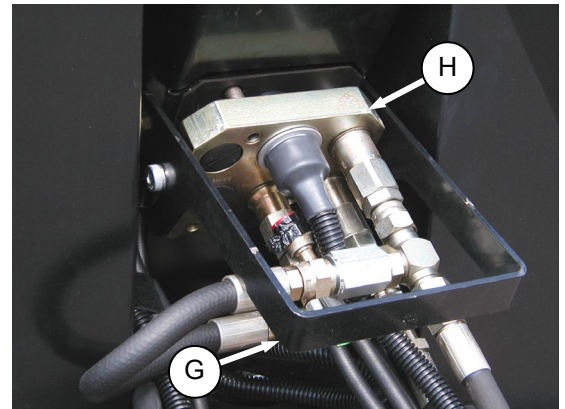

1. Pull handle (G) to release coupler (H) from adapter.

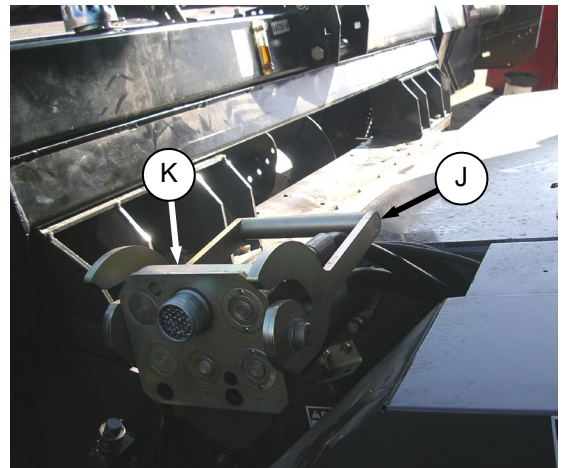

2. Push handle on combine (J) to full open position. Clean receptacle (K).

*(continued next page)*

## UNLOADING AND ASSEMBLY

### AGCO (Cont'd)

3. Position coupler (L) onto combine receptacle (K) and pull handle to fully engage coupler into receptacle.

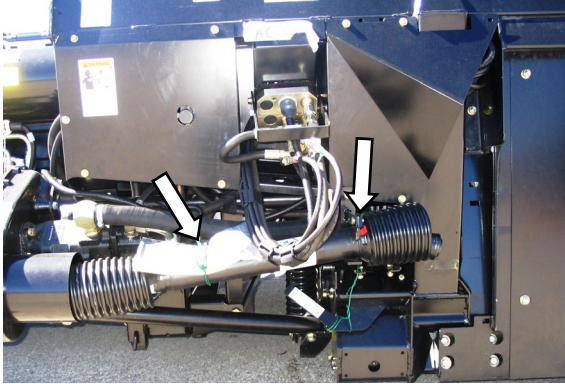

- i. Remove shipping wire securing driveline to adapter.

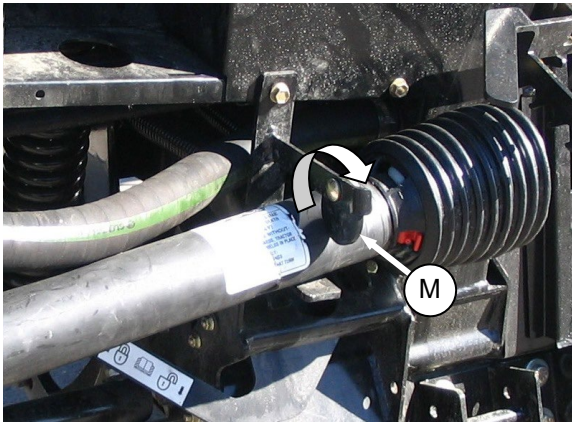

- j. Rotate disc (M) on adapter drive-line storage hook and remove drive-line from hook.



- k. Pull back collar (N) on end of drive line and push onto combine output shaft (O) until collar locks.

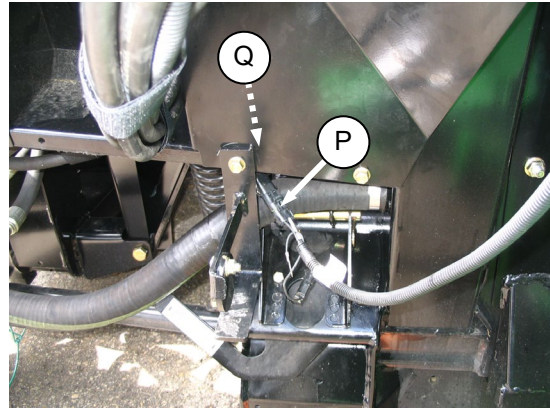

- l. Connect harness (P) to combine.

#### NOTE

*Connector (P) may need to be retrieved from hydraulics compartment access hole (Q).*

- m. Proceed to STEP 6. REMOVE SHIPPING SUPPORTS (page 34).

## UNLOADING AND ASSEMBLY

### STEP 6. REMOVE SHIPPING SUPPORTS

The removable supports are painted yellow. Refer to illustrations and remove supports as follows:

#### NOTE

*Unless otherwise specified, discard supports, and all shipping material and hardware.*

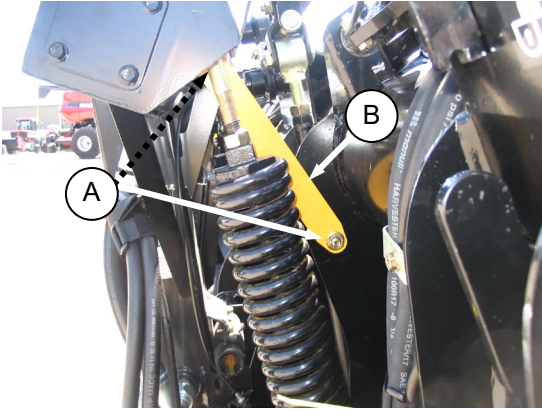

- a. Remove two bolts (A) and remove strap (B) from both sides of center frame.

#### NOTE

*If strap is difficult to remove, lift on one end of header to release the load on the strap so that bolts can be removed.*

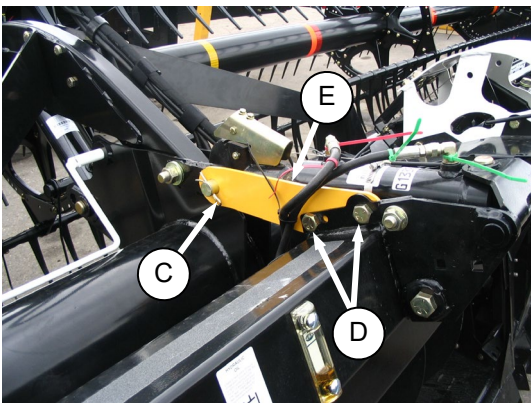

- b. Remove cotter pin (C), bolts (D), and remove shipping brace (E).
- c. Re-install cotter pin (C).

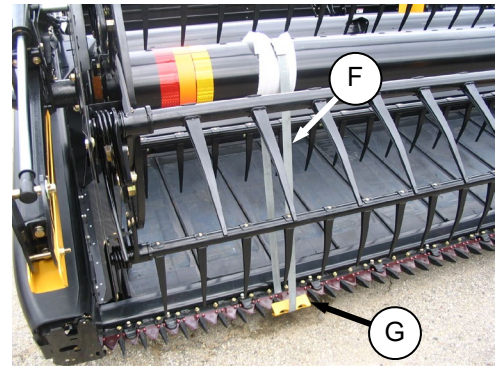

- d. Cut banding (F) securing reel to cutterbar and remove angle (G) on cutterbar and packing material from reel tube at three locations.



### CAUTION

**Reel arms must be level prior to removing reel shipping braces. Failure to do so may result in reel moving suddenly.**

- e. Start combine and level the reel arms with the combine hydraulics.

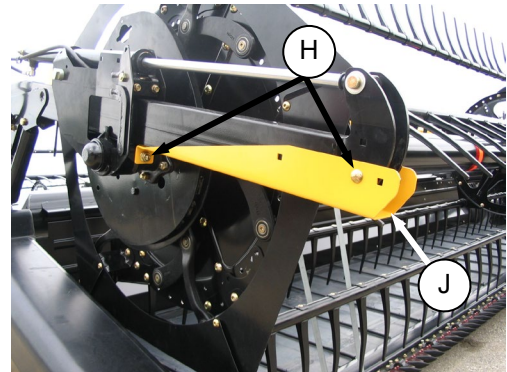

- f. Remove two bolts (H) attaching fore-aft brace (J) to reel arm and remove brace. Repeat for opposite arm and center arm.

### STEP 7. POSITION TRANSPORT LIGHTS



Position light perpendicular to header. Lights are located on each of the outboard reel arms.

## UNLOADING AND ASSEMBLY

### STEP 8. INSTALL CROP DIVIDERS

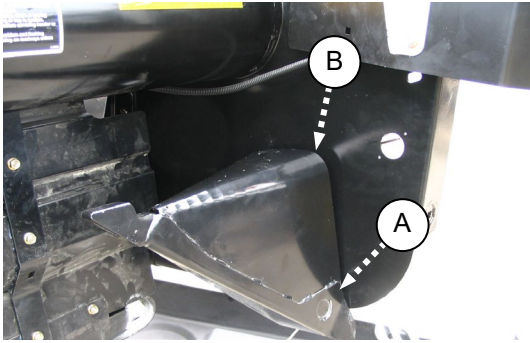

- a. At divider storage location, lift divider to disengage lugs (A) at lower end and then lower it slightly to disengage pin (B) from end sheet.

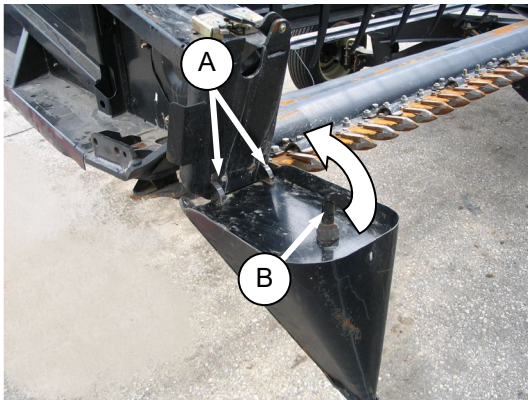

- b. Position crop divider as shown by locating lugs (A) in holes in end sheet.
- c. Lift forward end of divider until pin (B) at top of divider engages and closes latch (C).

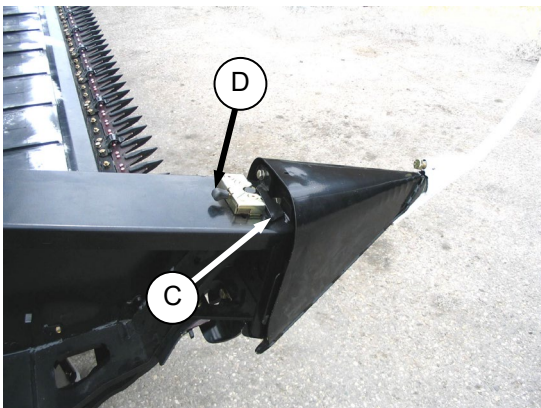

- d. Push safety lever (D) down to lock pin in latch.

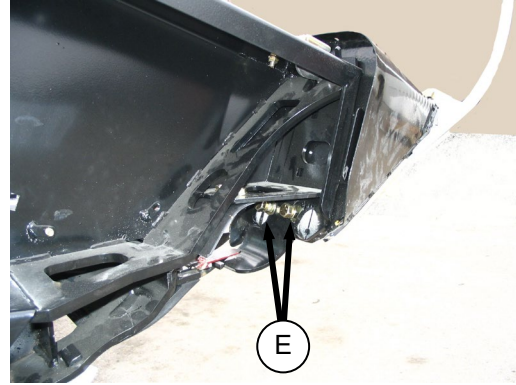

- e. Check that divider does not move laterally. Adjust bolts (E) as required to tighten divider and remove lateral play when pulling at divider tip.

## PRE-DELIVERY INSPECTION

### STEP 9. PERFORM PRE-DELIVERY CHECKS



#### WARNING

Stop combine engine and remove key before making adjustments to machine. A child or even a pet could engage the drive.

#### IMPORTANT

To avoid machine damage, check that no shipping dunnage has fallen into machine.

- a. Perform the final checks as listed on the "Pre-Delivery Checklist" (yellow sheet attached to this instruction) to ensure the machine is field-ready. Refer to the following pages for detailed instructions as indicated on the checklist.

#### IMPORTANT

The machine has been set at the factory and should require no further adjustments. However, perform the following checks to ensure your machine will provide maximum performance. Adjustments should be made only if absolutely necessary and in accordance with the instructions in this manual.

- b. The completed checklist should be retained either by the operator or the dealer.

### A. TIRE PRESSURE - SLOW SPEED TRANSPORT & STABILIZER WHEEL OPTIONS

Check tire inflation pressure. If necessary, inflate as per following table.

| YR             | TIRE                   | SIZE         | PRESSURE         |
|----------------|------------------------|--------------|------------------|
| 2006 & EARLIER | GOODYEAR WRANGLER RT/S | 205-75 R15   | 40 psi (276 kPa) |
| 2007 & LATER   | CARLISLE & TITAN       | ST205/75 R15 | 65 psi (448 kPa) |

#### IMPORTANT

Do not exceed maximum pressure specified on tire side wall.

### B. WHEEL BOLT TORQUE - SLOW SPEED TRANSPORT & STABILIZER WHEEL OPTIONS

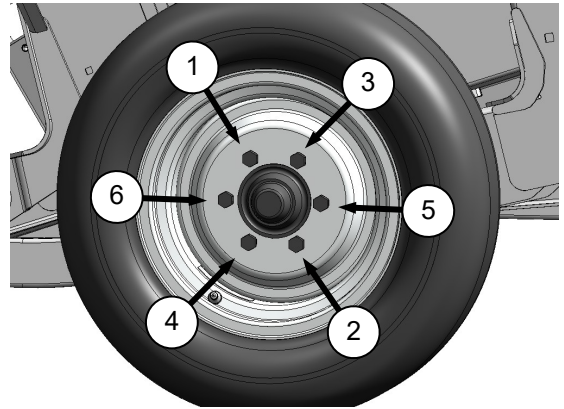

Check wheel bolt torque is 80-90 ft·lbf (110-120 N·m). Refer to bolt tightening sequence illustration.

### C. WOBBLE BOX

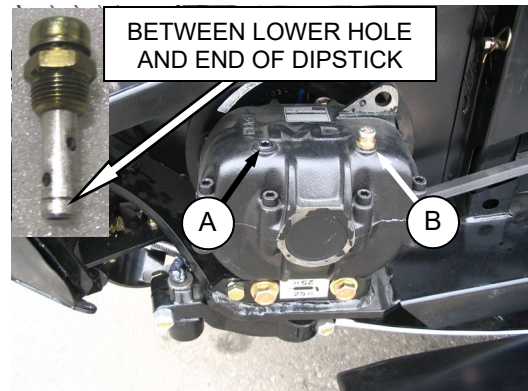

CHECK OIL LEVEL WITH TOP OF WOBBLE BOX HORIZONTAL

- a. Position of plug (A) and breather (B) at wobble box must be as shown.
- b. Check oil level.

## PRE-DELIVERY INSPECTION

### D. GEARBOX OIL

- a. Set cutterbar to working position.

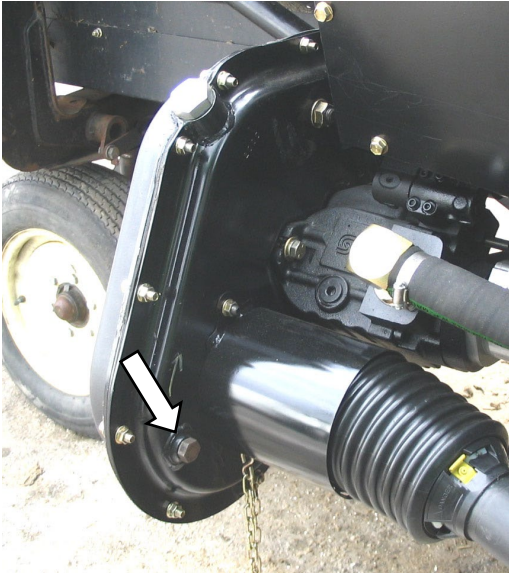

- b. Remove drain plug. Level should be to bottom of drain hole.

### E. HYDRAULIC RESERVOIR

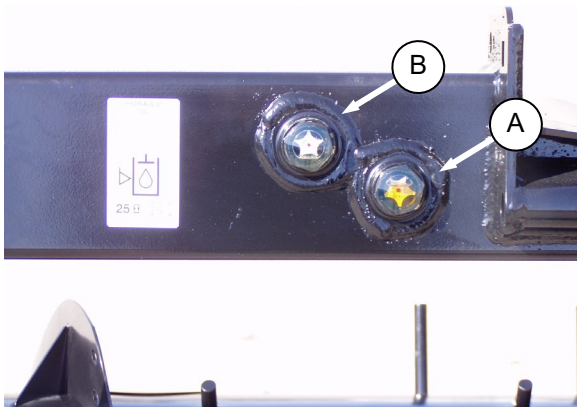

Check oil level at sights (A) and (B) with cutterbar just touching ground. Check when oil is cold and with center link retracted.

Nominal – Normal Terrain: Maintain level so lower sight (A) is full and upper sight (B) is empty.

#### NOTE

*When ambient temperatures are above 35° C (95° F), to prevent overflow at breather under operating temperatures, it may be necessary to lower oil level slightly.*

### F. SICKLE DRIVE BELT TENSION

- a. Remove LH and RH end shields.

#### NOTE

*The sickle drive is identical on both sides of the header.*

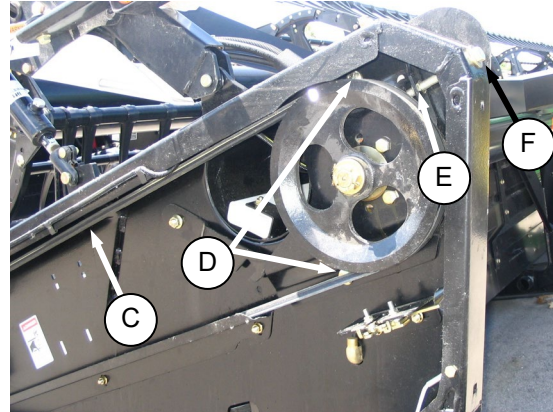

- b. A force of 20 lbf (80 N) should deflect belt (C) 3/4 in. (18 mm) at mid-span.
- c. If necessary, adjust tension as follows:
1. Loosen two bolts (D) on sickle drive mounting bracket and jam-nut (E).
  2. Turn adjuster bolt (F) to move drive motor until tension is achieved.
  3. Tighten jam nut (E) and bolts (D) on drive mounting bracket.
- d. Replace end shield.



## PRE-DELIVERY INSPECTION

### G. REEL CENTERING

- Raise header, shut down combine and engage header lift cylinder stops.
- Place two 6 inch (150 mm) blocks at ends of cutterbar.
- Disengage float locks and header lift cylinder locks.
- Start combine and lower header fully, allowing it to flex into full smile mode.

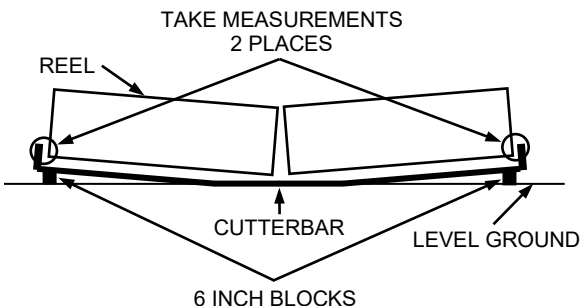

- Shut down engine.



### WARNING

**Stop /combine engine and remove key before making adjustments to machine. A child or even a pet could engage the drive.**

- Measure clearance between reels and both end sheets. The clearances should be the same if the reels are centered.
- If required center the reels as follows:

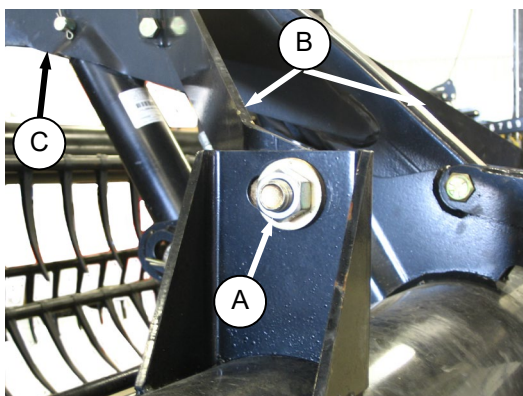

- Loosen bolt (A) on each brace (B).
- Move forward end of centre support arm (C) laterally as required to centre both reels.
- Tighten bolts (A) and torque to 265 ft·lbf (359 N·m).

## PRE-DELIVERY INSPECTION

### H. DRAPER TENSION

Raise header, and shut down engine. Engage header lift props.



#### WARNING

Stop combine engine and remove key before making adjustments to machine. A child or even a pet could engage the drive.



#### CAUTION

Engage header lift cylinder stops before working under header.

- a. Check that draper guide (rubber track on underside of draper) is properly engaged in groove of drive roller and that idler roller is between the guides.

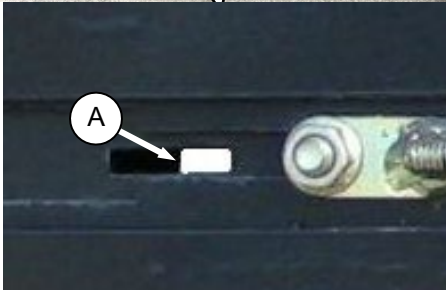
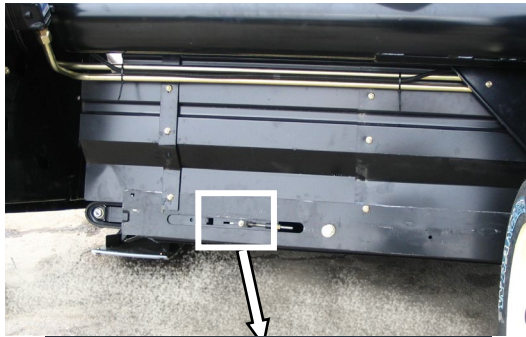

- b. Draper tension should be just enough to prevent slipping and keep draper from sagging below cutterbar. The white bar (A) should be about halfway in the window.

- c. If required, set draper tension as follows:

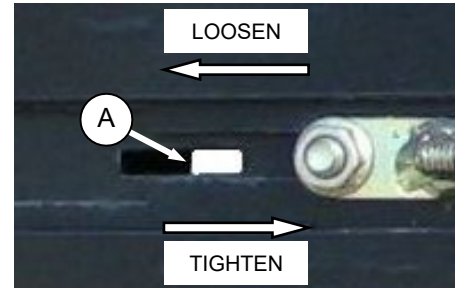
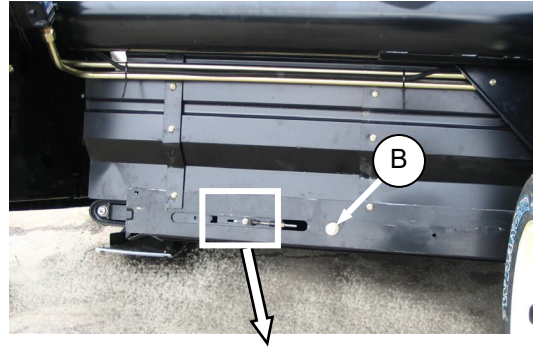

1. Turn bolt (B) clockwise (tighten) and white indicator bar (A) will move inboard in direction of arrow to indicate that draper is tightening.
2. Turn bolt (B) counterclockwise (loosen) and white indicator bar (A) will move outboard in direction of arrow to indicate that draper is loosening.
3. Adjust until bar is about halfway in window.

## PRE-DELIVERY INSPECTION

### I. HEADER MAIN FLOAT

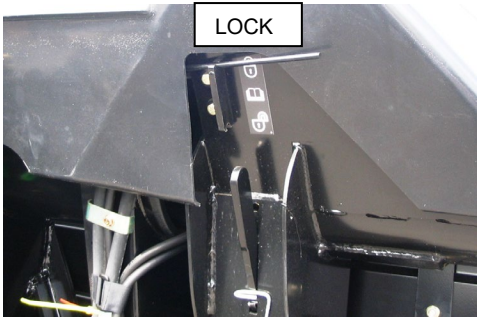

- a. Ensure both wing float locks are engaged.
- b. Ensure both header float lock levers are down (UNLOCK).

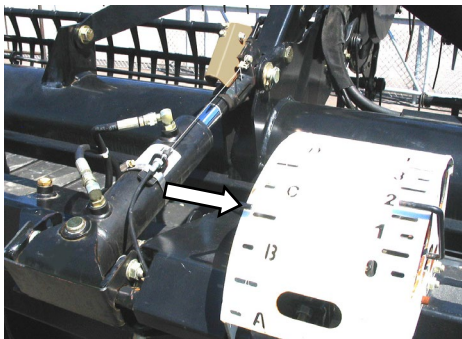

- c. Set center link to mid-range (B to C on float/angle indicator if installed). Adjust cutterbar to 6 to 10 inches (150-250 mm) above the ground.
- d. If header is equipped with stabilizer wheels or slow speed transport wheels, raise them off the ground so they are supported by the header. Refer to D50 and D60 Harvest Header/FD70 FlexDraper Operator's Manual.

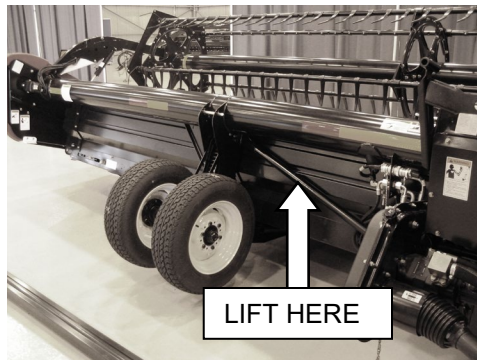

- e. Lift the header at the rear diagonal brace, or on the back-tube. The header should move up with approximately 75 lbf (334 N) force and then return to its original position.

#### NOTE

Check movement of bellcranks at base of adapter. They should move forward when the header is lifted and then return to the original position.

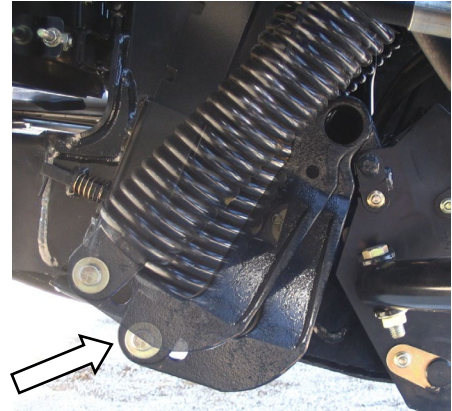

- f. If excessive force is required, the float adjustment is too low. If the header does not return to its original position, the float adjustment is too high. Adjust as follows:

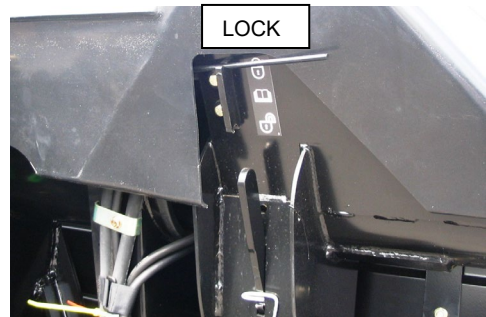

1. Ensure both wing float locks are engaged.

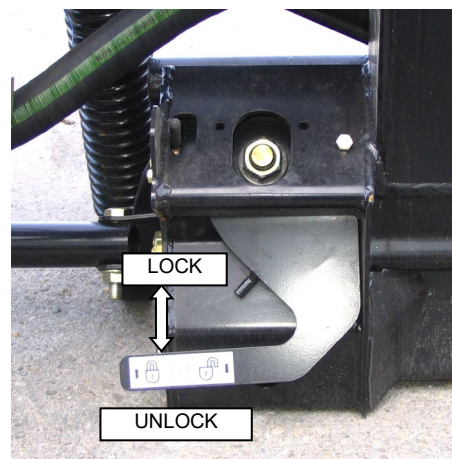

2. Ensure both header float lock levers are down (UNLOCK).

(continued next page)

## PRE-DELIVERY INSPECTION

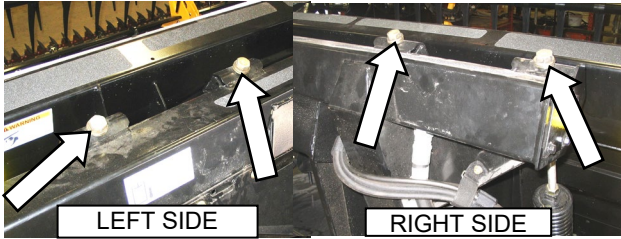

3. Tighten bolts at both sides of adapter to increase float (lightens the header).
4. Loosen bolts to decrease float (increases header weight).

### IMPORTANT

Turn each bolt pair equal amounts.

- g. The float is properly adjusted when:
- for **30, 35, and 40 ft single knife**;  
both sides of the header are adjusted to the same weight (approx. 75 lbf (334 N)).
  - for **40 ft double knife**;  
RH side is slightly heavier (loosen RH side adjuster bolts by 2 turns).

### IMPORTANT

Proper float adjustment in accordance with the above is critical for maintaining proper wing balance when cutting on the ground.

## PRE-DELIVERY INSPECTION

### J. TRIM SPRINGS

Check as follows that the float trim springs are properly installed:

- a. Fully retract tilt cylinder.

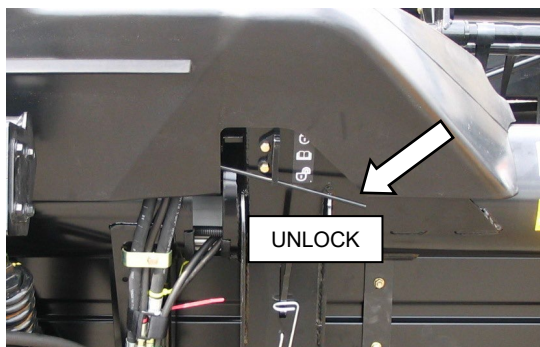

- b. Place spring handle in the lower slot to UNLOCK.

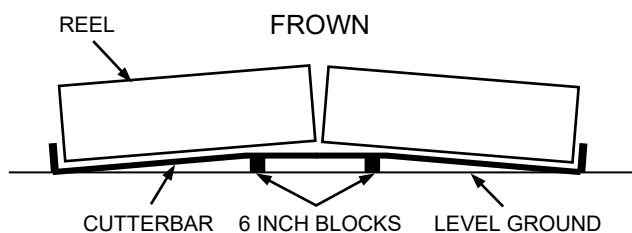

- c. Place 6 inch (150 mm) blocks under hinge area of cutterbar and lower header onto blocks so that header goes into a full frown, OR

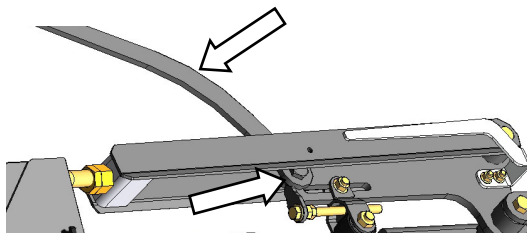

- d. Position cutterbar approximately 6 in. (150 mm) off the ground, and use special wrench on bolt head to frown the wings one at a time.

#### NOTE

*Wrench is located in RH header leg beneath spring handle.*

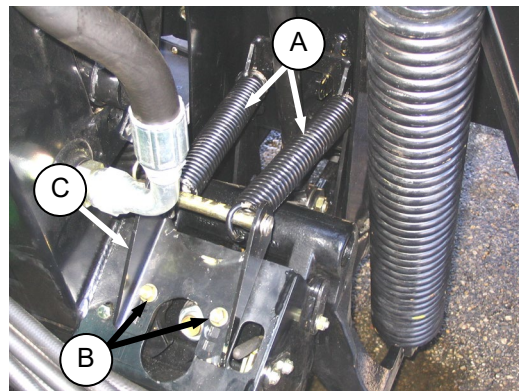

- e. Check that trim springs (A) are loose (no tension or compression) when the wings are in frown position.
- f. If necessary, remove bolts (B) and relocate rear trim spring bracket (C) in a different hole so that springs are loose when tilt cylinder is fully retracted and header is in full frown.

## PRE-DELIVERY INSPECTION

### K. CUTTERBAR ALIGNMENT

- a. Set cutterbar on level surface.

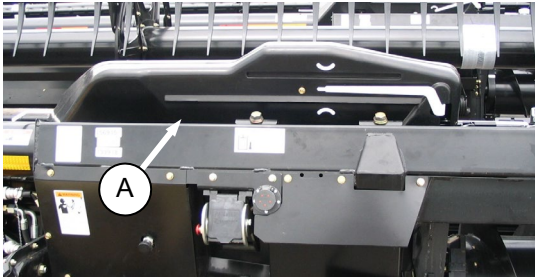

- b. Remove linkage cover (A).

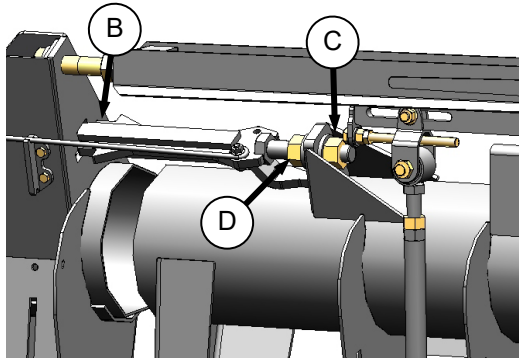

- c. Check that lock link (B) can be moved up and down in T-slot.  
 d. If not, unlock nuts (C) and (D) and adjust as required until link can be move up and down.  
 e. Tighten nuts (C) and (D) against spacer to 200-250 ft·lbf (270-350 N·m).

### L. WING BALANCE

- a. Extend tilt cylinder 2-3 inches (50-75 mm) and adjust header height so cutterbar is 6-10 inches (150-250 mm) off the ground.

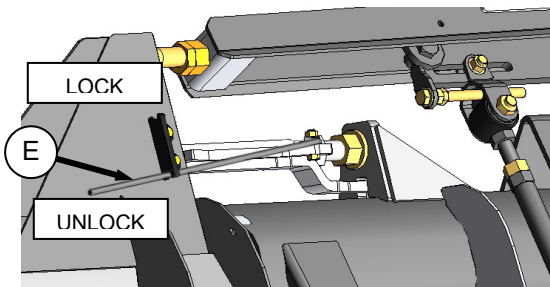

- b. Place spring handle (E) in the lower slot to UNLOCK.

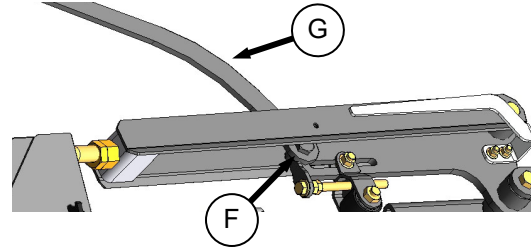

- c. If lock link cannot be moved, apply torque to bolt (F) with wrench (G) to move bell crank and release load in the lock link.

#### NOTE

*Wrench (G) is located in RH header leg beneath spring handle.*

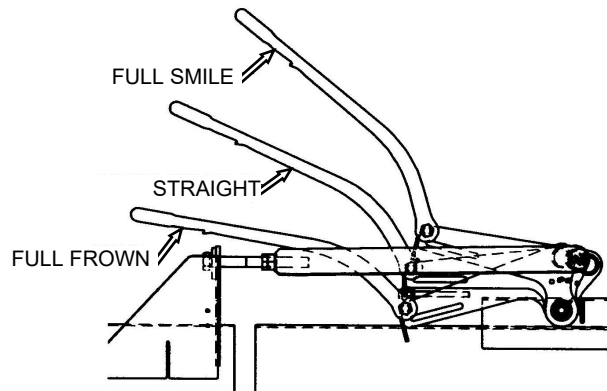

- d. Move the wing up and down by applying torque to bolt to turn the bell crank. The wing should move to full smile (wing up) and full frown (wing down) with same force on the wrench.

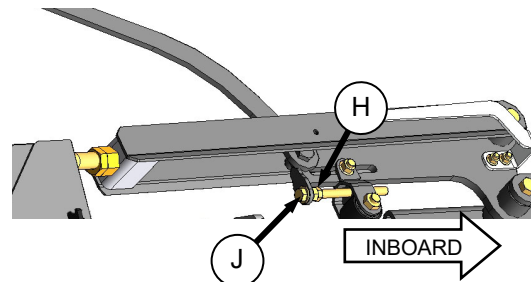

- e. If wing is too light, loosen clamp bolt (H) and turn draw bolt (J) counterclockwise to move the clevis inboard.  
 f. If wing is too heavy, turn draw bolt clockwise to move clevis outboard. Tighten clamp bolt (H).

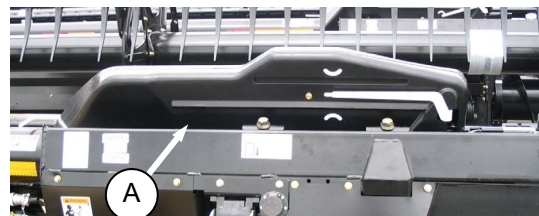

- g. Replace linkage covers (A) and wrench.

## PRE-DELIVERY INSPECTION

### M. SKID SHOE SETTINGS

- a. Note the hole positions on the adjuster legs (A) on each skid shoe. They should be the same.
- b. If necessary, adjust as follows:

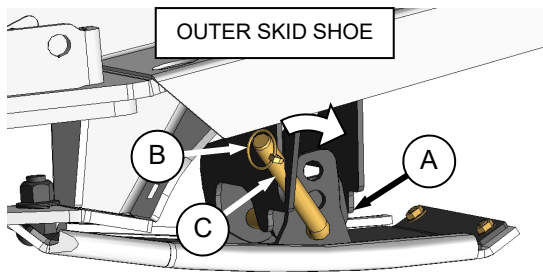
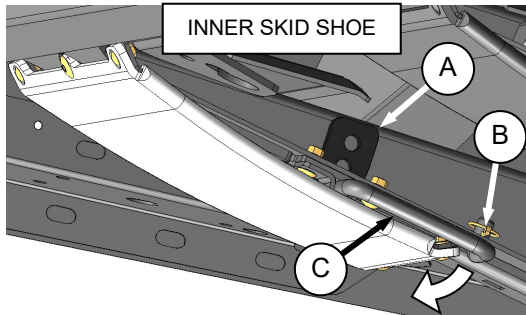

1. Remove lynch pin (B).
2. Hold shoe and remove pin (C) by disengaging frame and then pulling away from shoe.
3. Raise or lower skid shoe to desired position using holes in support as a guide.
4. Reinsert pin (C), engage in frame, and secure with lynch pin (B).
5. Check that skid shoes are adjusted to the same position.

## PRE-DELIVERY INSPECTION

### N. REEL TINE TO CUTTERBAR CLEARANCE

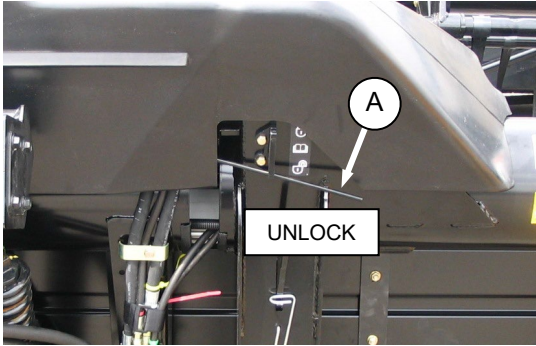

- Place spring handle (A) in lower slot to unlock the wings.



#### CAUTION

Engage header lift cylinder stops before working under header.

- Raise header, shut down combine and engage header lift cylinder stops.
- Place two 6 inch (150 mm) blocks just inboard of wing flex points.

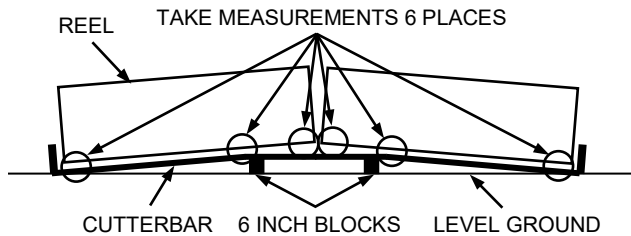

- Disengage header lift cylinder locks, start combine and lower header fully, allowing it to flex into full frown mode.

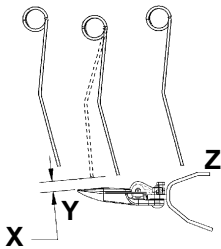

- Measure clearance 'X' at ends of each reel.

#### NOTE

*The reel has been adjusted at the factory to provide more clearance at the centre of the reel than at the ends (frown) to compensate for reel flexing.*

- Measure the clearance 'X' at both flex locations.

- Check all possible points of contact between points 'Y' and 'Z'. Depending on reel fore-aft position, minimum clearance can occur at guard tine, hold-down or cutterbar.

The finger to guard/cutterbar clearance with reels fully lowered is 0.78 +/- 0.12 in. (20 +/- 3 mm) measured **at both ends of each reel, and at the cutterbar flex locations** with the reel in full frown mode.

- If necessary, adjust outside arms as follows:

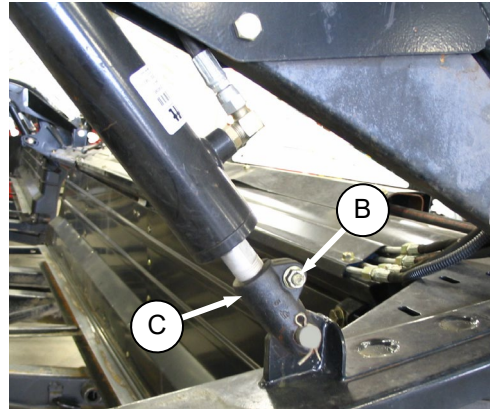

- Loosen bolt (B).
  - Turn cylinder rod (C) counter-clockwise to raise reel and increase clearance to cutterbar, or clockwise to decrease.
  - Tighten bolt (B).
  - Repeat at opposite side.
- If necessary, adjust centre arm as follows:

LOOKING UP AT ARM UNDERSIDE

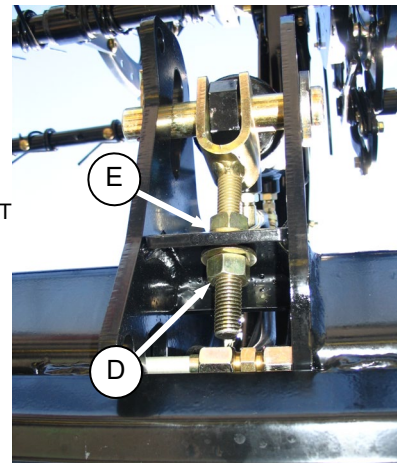

- Loosen nut (D).
- Turn nut (E) clockwise to raise reel and increase clearance to cutterbar, or counter-clockwise to decrease.
- Tighten bolt (D).



# PRE-DELIVERY INSPECTION

## O. LUBRICATE HEADER

Refer to the illustrations for lubrication points:

- Wipe grease fitting with a clean cloth before greasing, to avoid injecting dirt and grit.
- Inject grease through fitting with grease gun until grease overflows fitting, except where noted.
- Leave excess grease on fitting to keep out dirt.
- Replace any loose or broken fittings immediately.
- If fitting will not take grease, remove and clean thoroughly. Also clean lubricant passageway. Replace fitting if necessary.
- Use clean grease as shown.

High Temp. Extreme Pressure (EP2) Performance With 1% Max Molybdenum Disulphide (NLGI Grade 2).Lithium Base

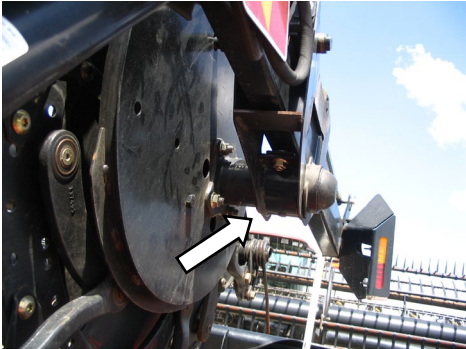

REEL SHAFT RH BEARING (1 PLC)

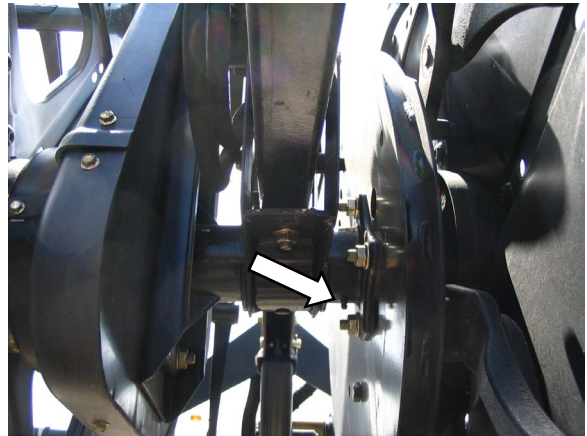

REEL CENTRE BEARING (1 PLC)

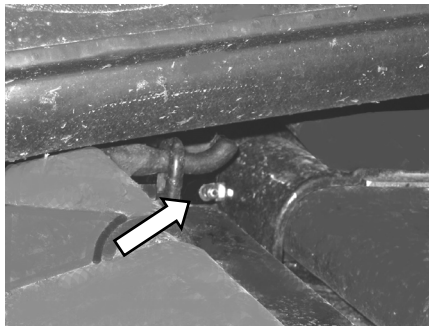

ADAPTER IDLER ROLLER (2 PLCS)

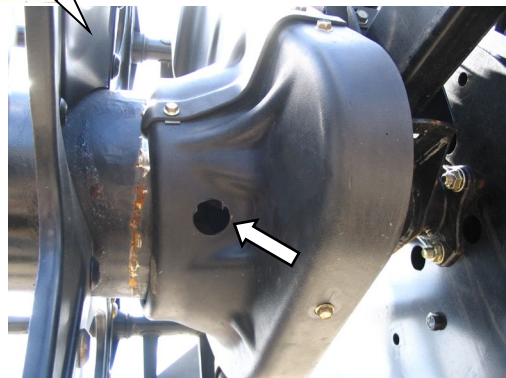

REEL UNIVERSAL (1 PLC)

*(continued next page)*

## PRE-DELIVERY INSPECTION

High Temp. Extreme Pressure  
(EP2) Performance With 1%  
Max Molybdenum Disulphide  
(NLGI Grade 2), Lithium Base



REEL SHAFT LH BEARING (1 PLC)

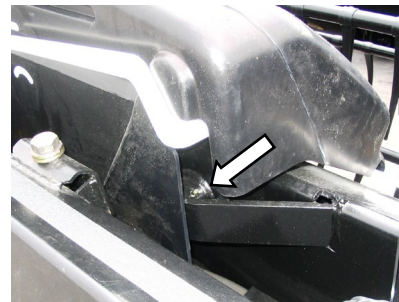

FLEX LINKAGE (BOTH SIDES)

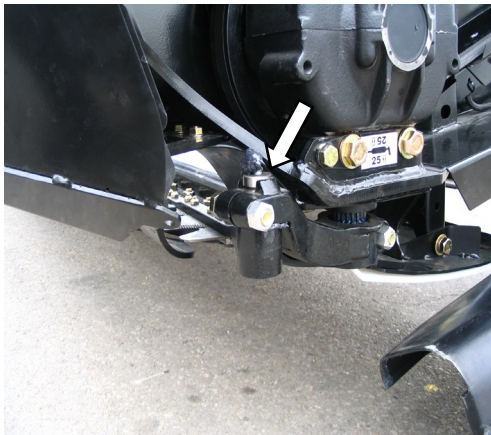

SICKLE HEAD  
(1 PLC SINGLE KNIFE/2 PLC DOUBLE KNIFE)

### NOTE

*To prevent binding and/or excessive wear caused by sickle pressing on guards, do not over grease. If more than 6 to 8 pumps of the grease gun are required to fill the cavity, replace the seal in the sickle head.*

*(continued next page)*

# PRE-DELIVERY INSPECTION

High Temp. Extreme Pressure  
(EP2) Performance With 1%  
Max Molybdenum Disulphide  
(NLGI Grade 2).Lithium Base

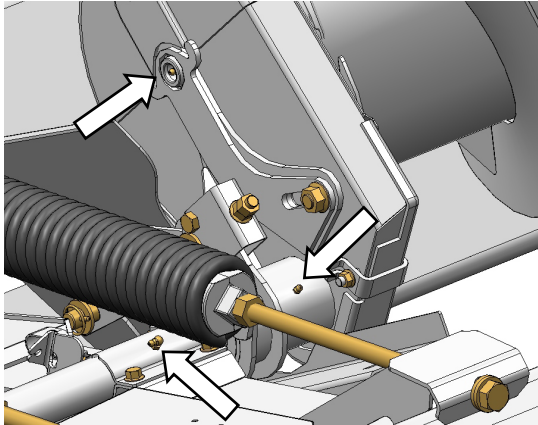
AUGER DRIVE (2 PLCS) AND PIVOT

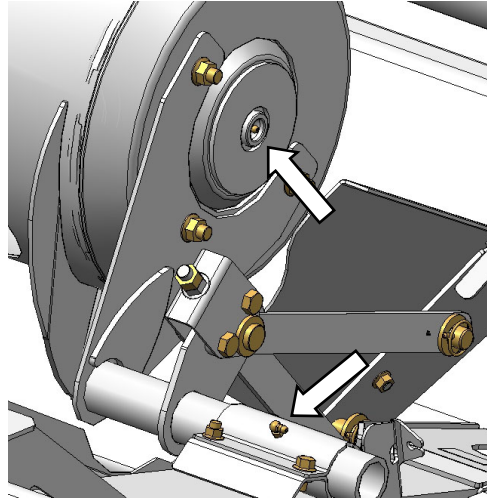

AUGER BEARING AND PIVOT

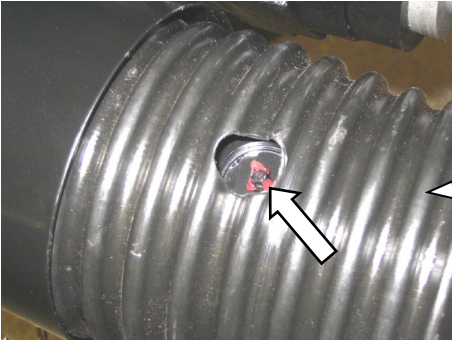

DRIVE UNIVERSAL – (2 PLCS.)

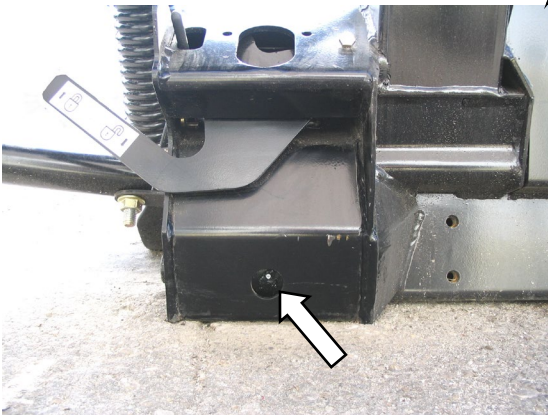
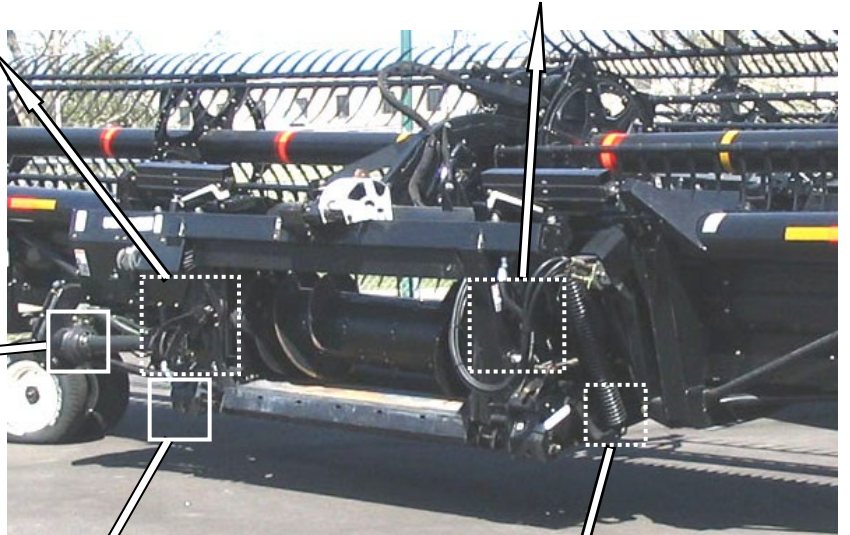

FLOAT PIVOT – BOTH SIDES

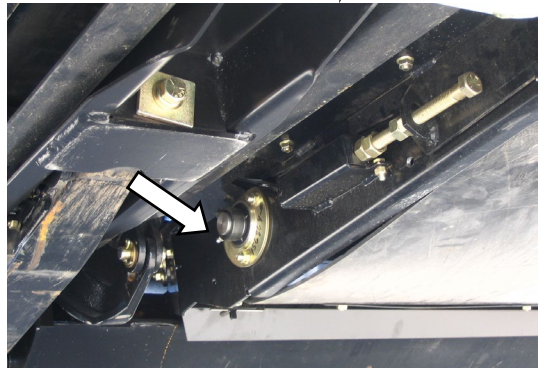

DRIVE ROLLER BEARING (1 PLC)

## PRE-DELIVERY INSPECTION

### P. OPERATOR'S MANUALS AND PARTS CATALOGUES

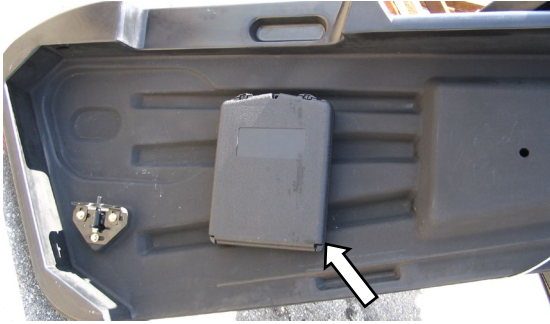

Check case contents. The manual case is located inside the left end shield.

- D50 and D60 Harvest Header / FD70 FlexDraper Operator's Manual #169006.
- D50 and D60 Harvest Header / FD70 FlexDraper Parts Catalogue #169008.
- CA20 Combine Adapter Operator's Manual #169009.
- CA20 Combine Adapter Parts Catalogue #169011.

### Q. INSTALL END SHIELDS

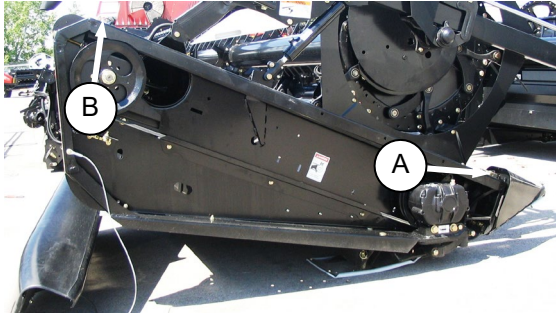

- a. Locate forward end in crop divider (A) and position shield over end sheet. Pin (B) at top of end sheet must engage shield.



- b. Push in shield at bottom and shield will self-latch.

#### NOTE

Plastic endshields are subject to expansion or contraction depending on large temperature variations. Latch pin can be adjusted to compensate for dimensional changes.

- c. The endshield should fit snugly onto the endsheet. If not, then adjust as follows:
1. Remove end shield.

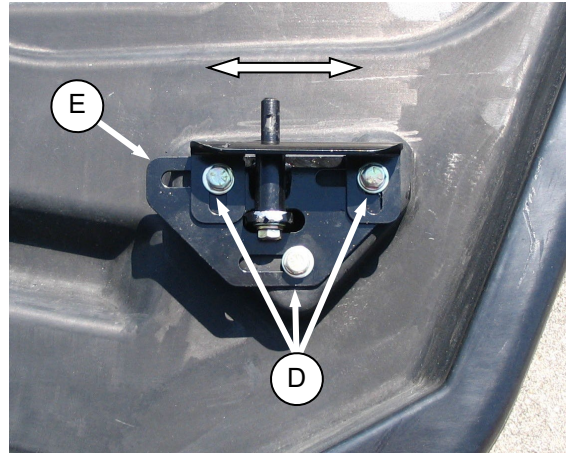

2. Loosen bolts (D) and adjust the pin assembly (E) to achieve the gap 'X' between the front end of the shield and the header frame in accordance with the following chart.

| TEMPERATURE<br>Deg. F. (C.) | GAP 'X'<br>Inches (mm) |
|-----------------------------|------------------------|
| 25 (-4)                     | 1.1 (28)               |
| 45 (7)                      | 1.0 (24)               |
| 65 (18)                     | 0.79 (20)              |
| 85 (29)                     | 0.64 (16)              |
| 105 (41)                    | 0.5 (12)               |
| 125 (52)                    | 0.32 (8)               |
| 145 (63)                    | 0.16 (4)               |
| 165 (89)                    | 0                      |

## PRE-DELIVERY INSPECTION

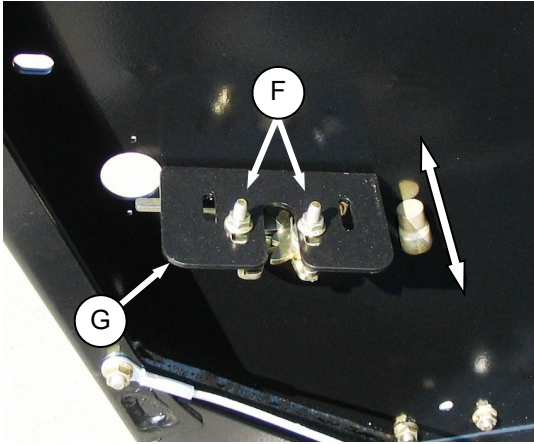

- d. Loosen bolts (F) and adjust the latch (G) to reposition the shield to achieve a snug fit between the aft end of the shield and header frame.

## RUN-UP ADJUSTMENTS AND CHECKS

### STEP 10. RUN-UP THE HEADER

- a. Start combine, raise header fully, and engage header lift cylinder locks. Shutdown combine and remove key.



#### WARNING

Stop combine engine and remove key before making adjustments to machine. A child or even a pet could engage the drive.



#### CAUTION

Engage header lift cylinder stops before working under header.

- b. Lower poly pan under adapter and check for shipping materials/debris that may have fallen under adapter draper as follows:

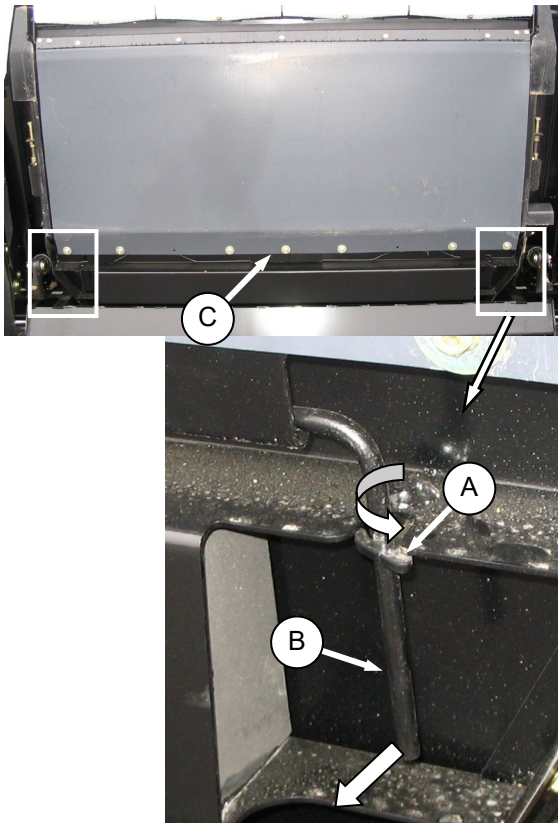

1. Rotate latches (A) to unlock handle (B).
2. Hold pan (C) and rotate handle (B) to release pan. Lower pan to expose draper.

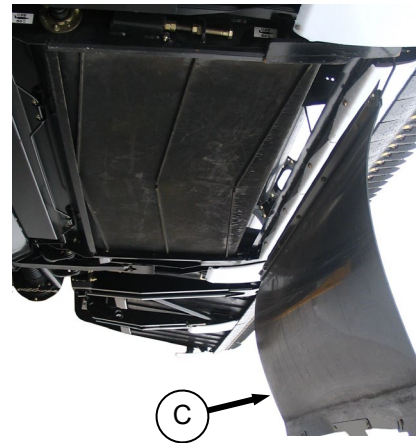

3. Check and remove debris from pan (C) and draper.

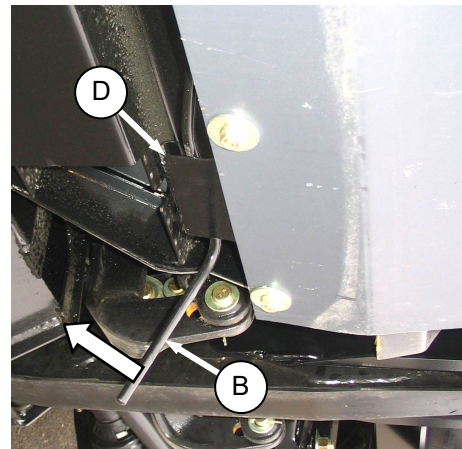

4. Raise pan and rotate handle (B) so that rod engages clips (D) on pan.

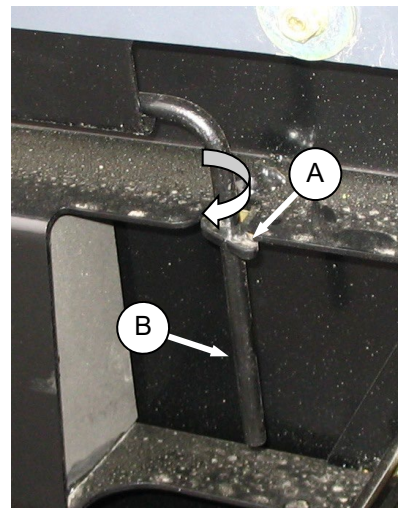

5. Push handle (B) into slot and secure with latches (A).

*(continued next page)*

## RUN-UP ADJUSTMENTS AND CHECKS



### CAUTION

Never start or move the machine until you are sure all bystanders have cleared the area.



### CAUTION

Clear the area of other persons, pets etc. Keep children away from machinery. Walk around the machine to be sure no one is under, on or close to it.



### CAUTION

Before investigating an unusual sound or attempting to correct a problem, shut off engine, engage parking brake and remove key.

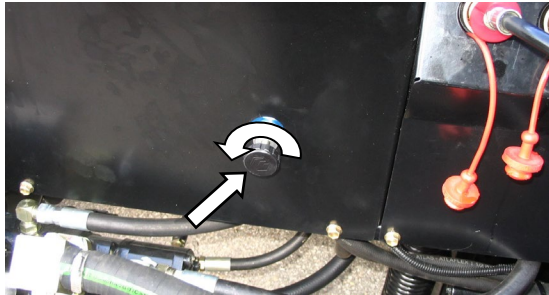

- c. Open side draper flow control 2 turns.
- d. Ensure feeder house variable speed is set to minimum.
- e. Start combine and run the machine for 15 minutes.
- f. Perform the run-up check as listed on the "Pre-Delivery Checklist" (yellow sheet attached to this instruction) to ensure the machine is field-ready.

## STEP 11. POST RUN-UP ADJUSTMENTS

The following adjustments may be necessary after the run-up:



### WARNING

Stop combine engine and remove key before making adjustments to machine. A child or even a pet could engage the drive.

- a. Check guards for signs of heating during run-up due to insufficient clearance between guard and sickle. If heating is evident, proceed as follows:

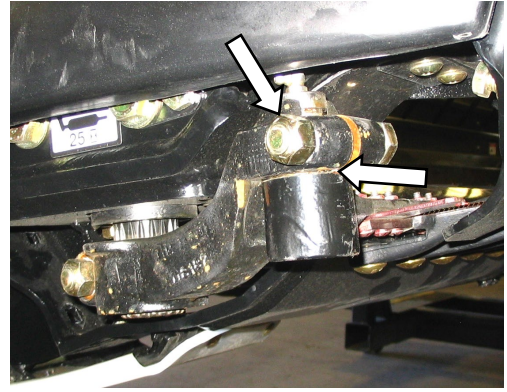

1. Check gap between knife head and pitman arm. A business card should slide easily through the gap. If not, then adjust gap by loosening bolt and tapping knife head with a hammer. Re-tighten bolt.
- b. Adjust guard alignment as follows: The guard straightening tool (MacDon #140135) is available from your dealer:



UPWARD ADJUSTMENT

1. To adjust guard tips upwards, position tool as shown at and pull up.



DOWNWARD ADJUSTMENT

2. To adjust tips downward, position tool as shown and push down.

# NOTES



## Model FD70 FlexDraper/CA20 Combine Adapter Pre-Delivery Checklist – N.A.

Perform these checks prior to delivery to your customer. **Adjustments are normally not required as the machine is factory assembled and adjusted.** If adjustments are required, refer to the appropriate page number in this manual. The completed checklist should be retained either by the operator or the dealer.



**CAUTION: Carefully follow the instructions given. Be alert for safety related messages which bring your attention to hazards and unsafe practices.**

Header Serial Number: \_\_\_\_\_

Adapter Serial Number: \_\_\_\_\_

| ✓ | <u>ITEM</u>   | <u>PAGE</u> |
|---|---|-------------|
|   | Check for shipping damage or missing parts. Be sure all shipping dunnage is removed.                    | -           |
|   | Check for loose hardware. Tighten to required torque.   | 5           |
|   | Check tire pressure (Transport/Stabilizer Option).  | 60          |
|   | Check wheel bolt torque (Transport/Stabilizer Option).  | 60          |
|   | Check wobble box breather position.   | 60          |
|   | Check wobble box lube level.  | 60          |
|   | Check adapter gearbox box lube level.   | 61          |
|   | Check hydraulic reservoir lube level before and after run-up.   | 61          |
|   | Check sickle drive belt(s) tension.   | 62          |
|   | Check reel centered between header endsheets (header in full smile).                                    | 62          |
|   | Grease all bearings and drivelines.   | 70          |
|   | Check side draper tension.  | 63          |
|   | Check wing balance.   | 67          |
|   | Check cutterbar alignment.  | 67          |
|   | Check header main float.  | 64          |
|   | Check reel tine to cutterbar clearance.   | 69          |
|   | Check skid shoes are evenly adjusted at a setting appropriate for first crop.                           | 68          |
|   | Check fitment of endshields.  | 74          |
|   | Ensure feeder house variable speed is set to minimum.   | -           |
|   | <b>RUN-UP PROCEDURE</b>   | 78          |
|   | Check hydraulic hose and wiring harness routing for clearance when raising or lowering header and reel. | -           |
|   | Check lights are functional.  | 59          |
|   | <b>POST RUN-UP CHECK. STOP ENGINE.</b>  | 79          |
|   | Check belt and chain drives for heated bearings.  | 12 &<br>62  |
|   | Check knife sections for discolouration caused by misalignment of components.                           | 77          |
|   | Check for hydraulic leaks.  | -           |
|   | Check manual storage case contains Operator's Manual and Parts Catalogs.                                | 77          |

Date Checked: \_\_\_\_\_

Checked by: \_\_\_\_\_





# MacDon™

**MacDon Industries Ltd.**

680 Moray Street  
Winnipeg, Manitoba  
Canada R3J 3S3  
t. (204) 885-5590  
f. (204) 832-7749

**MacDon Inc.**

10708 N. Pomona Avenue  
Kansas City, Missouri  
United States, 64153-1924  
t. (816) 891-7313  
f. (816) 891-7323

**MacDon Australia Pty. Ltd.**

A.C.N. 079 393 721  
P.O. Box 243  
Suite 3, 143 Main Street  
Greensborough, Victoria  
Australia 3088  
t. 03 9432 9982  
f. 03 9432 9972

CUSTOMERS

[www.macdon.com](http://www.macdon.com)

DEALERS

[www.macdondealers.com](http://www.macdondealers.com)

Trademarks of products are the marks of their  
respective manufacturers and/or distributors.

Printed in Canada