

M205
Self-Propelled Windrower

OPERATOR'S MANUAL

Revision C

Part #169469 \$25

This Manual contains instructions for “SAFETY”, “OPERATION”, and “MAINTENANCE/SERVICE” for your new MacDon Model M205 Self-Propelled Windrower.



CALIFORNIA

Proposition 65 Warning

Diesel engine exhaust and some of its constituents are known to the State of California to cause cancer, birth defects, and other reproductive harm.

Battery posts, terminals and related accessories contain lead and lead components. Wash hands after handling.

1 INTRODUCTION

This manual contains information on the MacDon Model M205 Self-Propelled Windrower that is designed to cut and lay in windrows, a wide variety of grain, hay and specialty crops. Windrowing allows starting the harvest earlier, protects the crop from wind damage, and gives you more flexibility in scheduling combine time.

The power unit (referred to in this manual as the “windrower”), when coupled with one of the specially designed auger, rotary, or draper headers, provides a package which incorporates many features and improvements in design. This manual must be used in conjunction with your Header Operator's Manual.

CAREFULLY READ ALL THE MATERIAL PROVIDED BEFORE ATTEMPTING TO UNLOAD, ASSEMBLE, OR USE THE MACHINE.

Use this manual as your first source of information about the machine. If you follow the instructions given in this manual, your M205 Windrower will work well for many years. If you require more detailed service information, check with your dealer.

Use the Table of Contents and the Index to guide you to specific areas. Study the Table of Contents to familiarize yourself with how the material is organized.

Keep this manual handy for frequent reference and to pass on to new operators or owners. Call your dealer if you need assistance, information, or additional copies of this manual. A manual storage case is provided in the cab.

NOTE: The M205 Windrower is Dual Direction™, meaning that the windrower can be driven in the cab-forward or the engine-forward modes. Right-Hand and Left-Hand designations are therefore determined by the operator's position, facing the direction of travel. This manual uses the terms right cab-forward, left cab-forward, right engine-forward, and left engine-forward when referencing specific locations on the machine.

Published: December, 2010

2 MODEL AND SERIAL NUMBER

Record the Model Number, Serial Number, and Model Year of the Header, Slow Speed Transport/Stabilizer Wheel Option (if installed), and the Combine Adapter on the lines below:

WINDROWER SERIAL NO. _____ YEAR _____

Serial Number Plate is located on the left cab-forward side of the main frame near the walking beam.

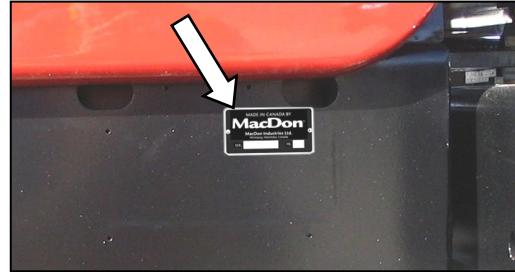

ENGINE SERIAL NO. _____ YEAR _____

Serial Number Plate is located on the top face of the engine cylinder head cover.

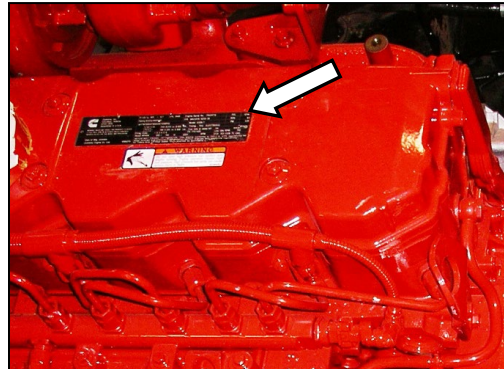

TABLE OF CONTENTS

| Section/Title | Page |
|--|-----------|
| 1 INTRODUCTION | 1 |
| 2 MODEL AND SERIAL NUMBER | 2 |
| 3 SAFETY | 7 |
| 3.1 SAFETY ALERT SYMBOL | 7 |
| 3.2 SIGNAL WORDS | 7 |
| 3.3 SAFETY SIGNS | 7 |
| 3.3.1 <i>Safety Sign Installation</i> | 7 |
| 3.3.2 <i>Safety Sign Locations</i> | 7 |
| 3.4 GENERAL SAFETY | 12 |
| 4 PRODUCT DESCRIPTION | 14 |
| 4.1 DEFINITIONS | 14 |
| 4.2 SPECIFICATIONS | 15 |
| 4.3 WINDROWER DIMENSIONS | 17 |
| 4.4 COMPONENT IDENTIFICATION | 19 |
| 5 OPERATOR'S STATION | 20 |
| 5.1 OPERATOR CONSOLE | 20 |
| 5.2 OPERATOR PRESENCE | 21 |
| 5.2.1 <i>Header Drive</i> | 21 |
| 5.2.2 <i>Engine and Transmission</i> | 21 |
| 5.3 SEAT ADJUSTMENTS | 21 |
| 5.4 TRAINING SEAT | 22 |
| 5.5 SEAT BELTS | 22 |
| 5.6 STEERING COLUMN ADJUSTMENT | 22 |
| 5.7 LIGHTS | 23 |
| 5.7.1 <i>Cab-forward Lighting: Field</i> | 23 |
| 5.7.2 <i>Engine-forward Lighting: Road</i> | 24 |
| 5.7.3 <i>Cab-forward Lighting: Road (Optional)</i> | 24 |
| 5.7.4 <i>Beacon Lighting: Export (N.A. Optional)</i> | 25 |
| 5.8 WINDSHIELD WIPERS | 26 |
| 5.9 REAR VIEW MIRRORS | 26 |
| 5.10 CAB TEMPERATURE | 26 |
| 5.10.1 <i>Heater Shut-Off Valve</i> | 26 |
| 5.10.2 <i>Air Distribution</i> | 26 |
| 5.10.3 <i>Controls</i> | 27 |
| 5.10.4 <i>A/C Compressor Protection</i> | 27 |
| 5.11 INTERIOR LIGHTS | 27 |
| 5.12 OPERATOR AMENITIES | 28 |
| 5.13 RADIOS | 29 |
| 5.13.1 <i>AM/FM Radio</i> | 29 |
| 5.13.2 <i>Antenna Mounting</i> | 29 |
| 5.14 HORN | 29 |
| 5.15 ENGINE CONTROLS/GAUGES | 30 |
| 5.16 WINDROWER CONTROLS | 31 |
| 5.17 HEADER CONTROLS | 32 |
| 5.17.1 <i>Header Engage Switch</i> | 32 |
| 5.17.2 <i>Header Drive Reverse Button</i> | 32 |
| 5.17.3 <i>GSL Header Switches</i> | 33 |
| 5.17.4 <i>Console Header Switches</i> | 34 |
| 5.18 CAB DISPLAY MODULE (CDM) | 35 |
| 5.18.1 <i>Engine and Windrower Functions</i> | 35 |
| 5.18.2 <i>Header Functions</i> | 35 |
| 5.18.3 <i>Operating Screens</i> | 36 |
| 5.18.4 <i>Cab Display Module (CDM) Warnings/Alarms</i> | 43 |
| 5.18.5 <i>Cab Display Module (CDM) Programming</i> | 46 |
| 5.18.6 <i>Setting Guidelines</i> | 53 |
| 5.18.7 <i>Engine Error Codes</i> | 53 |
| 5.18.8 <i>CDM & WCM Fault Codes</i> | 53 |
| 6 OPERATION | 54 |

TABLE OF CONTENTS

| | | |
|----------|---|------------|
| 6.1 | OWNER/OPERATOR RESPONSIBILITIES | 54 |
| 6.2 | SYMBOL DEFINITIONS | 54 |
| 6.2.1 | <i>Engine Functions</i> | 54 |
| 6.2.2 | <i>Windrower Operating Symbols</i> | 54 |
| 6.2.3 | <i>Header Functions</i> | 55 |
| 6.3 | WINDROWER OPERATION | 56 |
| 6.3.1 | <i>Operational Safety</i> | 56 |
| 6.3.2 | <i>Break-In Period</i> | 56 |
| 6.3.3 | <i>Pre-Season Check</i> | 57 |
| 6.3.4 | <i>Daily Check</i> | 57 |
| 6.3.5 | <i>Engine Operation</i> | 58 |
| 6.3.6 | <i>Driving The Windrower</i> | 62 |
| 6.3.7 | <i>Adjustable Caster Tread Width</i> | 68 |
| 6.3.8 | <i>Transporting</i> | 70 |
| 6.3.9 | <i>Storage</i> | 79 |
| 6.4 | HEADER OPERATION..... | 80 |
| 6.4.1 | <i>Header Lift Cylinder Stops</i> | 80 |
| 6.4.2 | <i>Header Flotation</i> | 81 |
| 6.4.3 | <i>Levelling</i> | 84 |
| 6.4.4 | <i>Header Drive</i> | 85 |
| 6.4.5 | <i>Header Angle</i> | 86 |
| 6.4.6 | <i>Cutting Height</i> | 88 |
| 6.4.7 | <i>Double Windrowing</i> | 90 |
| 6.5 | D SERIES HEADER OPERATION..... | 91 |
| 6.5.1 | <i>Header Attachment</i> | 91 |
| 6.5.2 | <i>Header Detachment</i> | 95 |
| 6.5.3 | <i>Header Position</i> | 97 |
| 6.5.4 | <i>Reel Fore-Aft Position</i> | 97 |
| 6.5.5 | <i>Reel Height</i> | 97 |
| 6.5.6 | <i>Reel Speed</i> | 98 |
| 6.5.7 | <i>Draper Speed</i> | 100 |
| 6.5.8 | <i>Knife Speed</i> | 102 |
| 6.5.9 | <i>Deck Shift (Optional)</i> | 103 |
| 6.6 | A SERIES HEADER OPERATION..... | 104 |
| 6.6.1 | <i>Header Attachment</i> | 104 |
| 6.6.2 | <i>Header Detachment</i> | 107 |
| 6.6.3 | <i>Auger Speed</i> | 109 |
| 6.6.4 | <i>Reel Speed</i> | 110 |
| 6.6.5 | <i>Knife Speed</i> | 112 |
| 6.7 | R SERIES HEADER OPERATION..... | 113 |
| 6.7.1 | <i>Header Attachment</i> | 113 |
| 6.7.2 | <i>Header Detachment</i> | 116 |
| 6.7.3 | <i>Disc Speed</i> | 118 |
| 7 | MAINTENANCE/SERVICE | 119 |
| 7.1 | PREPARATION FOR SERVICING..... | 119 |
| 7.1.1 | <i>Welding Precautions</i> | 119 |
| 7.2 | RECOMMENDED SAFETY PROCEDURES | 119 |
| 7.3 | MAINTENANCE SPECIFICATIONS..... | 120 |
| 7.3.1 | <i>Recommended Fuel, Fluids And Lubricants</i> | 120 |
| 7.3.2 | <i>Recommended Torques</i> | 121 |
| 7.3.3 | <i>Conversion Chart</i> | 123 |
| 7.4 | ENGINE COMPARTMENT HOOD | 124 |
| 7.5 | MAINTENANCE PLATFORMS..... | 125 |
| 7.5.1 | <i>Opening/Closing Platforms</i> | 125 |
| 7.5.2 | <i>Opening/Closing Platform for Major Servicing</i> | 125 |
| 7.6 | LUBRICATING THE WINDROWER | 127 |
| 7.6.1 | <i>Procedure</i> | 127 |
| 7.6.2 | <i>Lubrication Points</i> | 127 |
| 7.7 | OPERATOR'S STATION..... | 129 |
| 7.7.1 | <i>Seat Belts</i> | 129 |
| 7.7.2 | <i>Safety Systems</i> | 129 |
| 7.7.3 | <i>GSL Adjustments</i> | 130 |
| 7.7.4 | <i>Steering Adjustments</i> | 131 |

TABLE OF CONTENTS

| | | |
|----------|---|------------|
| 7.7.5 | <i>Park Brake</i> | 133 |
| 7.7.6 | <i>HVAC System</i> | 135 |
| 7.8 | ENGINE | 138 |
| 7.8.1 | <i>General Engine Inspection</i> | 138 |
| 7.8.2 | <i>Manually Turning Engine</i> | 139 |
| 7.8.3 | <i>Oil Level</i> | 140 |
| 7.8.4 | <i>Changing Oil and Oil Filter</i> | 141 |
| 7.8.5 | <i>Air Intake System</i> | 142 |
| 7.8.6 | <i>Fuel System</i> | 146 |
| 7.8.7 | <i>Engine Cooling System</i> | 150 |
| 7.8.8 | <i>Gearbox</i> | 153 |
| 7.8.9 | <i>Exhaust System</i> | 155 |
| 7.8.10 | <i>Belts</i> | 156 |
| 7.8.11 | <i>Engine Speed</i> | 158 |
| 7.9 | COOLING BOX | 159 |
| 7.9.1 | <i>Cooling Box Screen</i> | 159 |
| 7.9.2 | <i>Rotor To Screen Clearance</i> | 160 |
| 7.9.3 | <i>Cooling Box Maintenance</i> | 161 |
| 7.10 | ELECTRICAL SYSTEM | 164 |
| 7.10.1 | <i>Battery</i> | 164 |
| 7.10.2 | <i>Headlights: Engine-forward</i> | 169 |
| 7.10.3 | <i>Field lights: Cab-forward</i> | 171 |
| 7.10.4 | <i>Flood Lights - Forward</i> | 172 |
| 7.10.5 | <i>Flood Lights - Rear</i> | 173 |
| 7.10.6 | <i>Red and Amber Lights</i> | 174 |
| 7.10.7 | <i>Red Tail Lights (If Installed)</i> | 174 |
| 7.10.8 | <i>Beacons (If Installed)</i> | 175 |
| 7.10.9 | <i>Gauge Light</i> | 177 |
| 7.10.10 | <i>Dome Light</i> | 177 |
| 7.10.11 | <i>Ambient Light</i> | 177 |
| 7.10.12 | <i>Turn Signal Indicators</i> | 177 |
| 7.10.13 | <i>Circuit Breakers and Fuses</i> | 178 |
| 7.11 | HYDRAULIC SYSTEM | 181 |
| 7.11.1 | <i>Oil Level</i> | 181 |
| 7.11.2 | <i>Hydraulic Oil Cooler</i> | 182 |
| 7.11.3 | <i>Changing Hydraulic Oil</i> | 182 |
| 7.11.4 | <i>Hydraulic Oil Filters</i> | 182 |
| 7.11.5 | <i>Header and Reel Hydraulics</i> | 184 |
| 7.11.6 | <i>Traction Drive Hydraulics</i> | 186 |
| 7.11.7 | <i>Hoses and Lines</i> | 187 |
| 7.12 | WHEELS AND TIRES | 188 |
| 7.12.1 | <i>Drive Wheels</i> | 188 |
| 7.12.2 | <i>Caster Wheels</i> | 191 |
| 7.13 | MAINTENANCE SCHEDULE | 195 |
| 7.13.1 | <i>Break-In Inspection</i> | 195 |
| 7.13.2 | <i>Interval Maintenance</i> | 196 |
| 8 | TROUBLESHOOTING | 199 |
| 8.1 | ENGINE | 199 |
| 8.2 | ELECTRICAL | 202 |
| 8.3 | HYDRAULICS | 202 |
| 8.4 | HEADER DRIVE | 203 |
| 8.5 | TRACTION DRIVE | 203 |
| 8.6 | STEERING AND GROUND SPEED CONTROL | 204 |
| 8.7 | CAB AIR | 205 |
| 8.8 | OPERATOR'S STATION | 207 |
| 9 | OPTIONS / ATTACHMENTS | 208 |
| 9.1 | COMPLETION KIT FOR AUGER & DRAPER HEADER DRIVES | 208 |
| 9.2 | COMPLETION KIT FOR DRAPER HEADER REEL DRIVE | 208 |
| 9.3 | COMPLETION KIT FOR AUGER HEADER DRIVE and CONDITIONER REVERSER | 208 |
| 9.4 | QUICK COUPLER KIT | 208 |
| 9.5 | DOUBLE WINDROW ATTACHMENT | 208 |
| 9.6 | BOOSTER SPRING KIT | 208 |

TABLE OF CONTENTS

| | | |
|---------------------------|--|-----|
| 9.7 | INTERNAL BOOSTER SPRING KIT | 208 |
| 9.8 | LIGHT HEADER FLOTATION KIT | 208 |
| 9.9 | WINDSHIELD SHADES | 208 |
| 9.10 | AM-FM RADIO | 208 |
| 9.11 | PRESSURE SENSOR KIT | 208 |
| 9.12 | WEIGHT BOX | 208 |
| 9.13 | TOWING HARNESS | 208 |
| 9.14 | SWATH ROLLER | 208 |
| 9.15 | WARNING BEACONS | 208 |
| 9.16 | AUTO-STEER | 208 |
| 9.17 | LIGHTING AND MARKING KIT FOR CAB-FORWARD ROAD TRAVEL | 209 |
| 9.18 | FAN AIR BAFFLE KIT | 209 |
| INDEX | | 207 |
| CDM/WCM FAULT CODES | | 210 |
| ENGINE ERROR CODES | | 211 |

SAFETY

3 SAFETY

3.1 SAFETY ALERT SYMBOL



This safety alert symbol indicates important safety messages in this manual and on safety signs on the machine.

This symbol means:

**ATTENTION!
BECOME ALERT!
YOUR SAFETY IS INVOLVED!**

Carefully read and follow the safety message accompanying this symbol.

WHY IS SAFETY IMPORTANT TO YOU?

**ACCIDENTS DISABLE AND KILL.
ACCIDENTS COST.
ACCIDENTS CAN BE AVOIDED.**

3.2 SIGNAL WORDS

Note the use of the signal words **DANGER**, **WARNING**, and **CAUTION** with safety messages. The appropriate signal word for each message has been selected using the following guidelines:



DANGER

Indicates an imminently hazardous situation that, if not avoided, will result in death or serious injury.



WARNING

Indicates a potentially hazardous situation that, if not avoided, could result in death or serious injury. It is also used to alert against unsafe practices.



CAUTION

Indicates a potentially hazardous situation that, if not avoided, may result in minor or moderate injury. It is also used as a reminder of good safety practices.

3.3 SAFETY SIGNS

3.3.1 SAFETY SIGN INSTALLATION

Refer to the illustration on this and following pages and proceed as follows:

- Be sure the installation area is clean and dry.
- Decide on the exact location before you remove the decal backing paper.
- Remove the smaller portion of the split backing paper.
- Place the sign in position and slowly peel back the remaining paper, smoothing the sign as it is applied.
- Small air pockets can be smoothed out or pricked with a pin.

3.3.2 SAFETY SIGN LOCATIONS

The safety signs (decals) appear on the windrower at the locations approximately as shown.

- Keep safety signs clean and legible at all times.
- Replace safety signs that are missing or become illegible.
- If original parts on which a safety sign was installed are replaced, be sure the repair part also bears the current safety sign.
- Safety signs are available from your Dealer Parts Department.

SAFETY

Safety Sign Locations (continued)



IN CAB #32744



BELOW DOOR HANDLE #32744

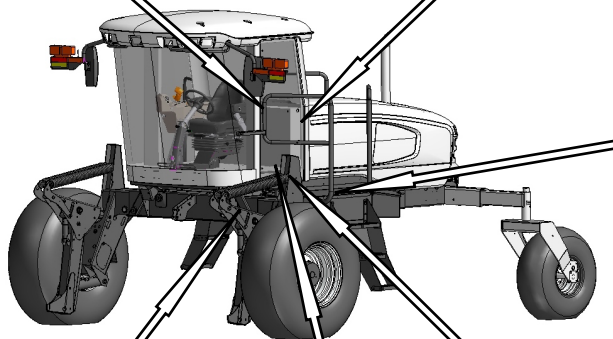

HEADER LOCKS



LIFT LINKAGES #163561

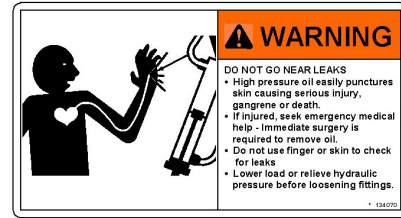

FRONT OF PLATFORM #134070

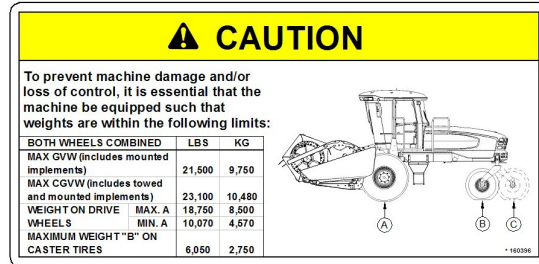

BEHIND DOOR ON SILL - LH SIDE ONLY #160396

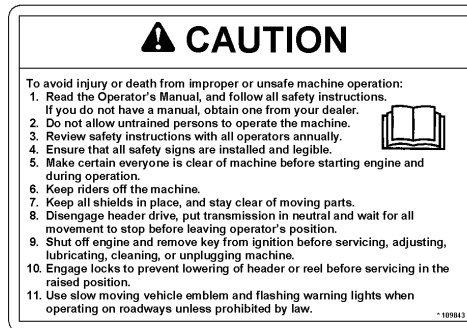

BEHIND DOOR ON SILL #109843

SAFETY

Safety Sign Locations (continued)

⚠ WARNING

Collision between windrower and other vehicles may result in injury or death.

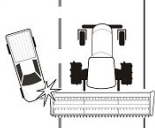

When driving windrower on public roadways:

1. Obey all highway traffic regulations in your area. Use pilot vehicles front and rear of windrower if required by law.
2. Use slow moving vehicle emblem and flashing warning lights unless prohibited by law.
3. If width of attached header impedes other vehicle traffic, remove header and install a MacDon approved weight box. Refer to Operator's Manual for safe procedure to tow header.



* 160422

IN CAB #160422

⚠ WARNING

The training seat is provided for an experienced operator of the machine when a new operator is being trained.

The training seat is NOT intended as a PASSENGER SEAT or FOR USE BY CHILDREN.

USE THE SEAT BELT whenever operating the machine or riding as a trainer.



KEEP ALL OTHER RIDERS OFF THE MACHINE.

* 109868

IN CAB #109868

⚠ WARNING

1. Machine will move if steering wheel is turned while engine is running.
2. Steering response is opposite to what is normally expected when backing up. Turn bottom of steering wheel in direction you want to go.
3. Always move ground speed lever to slow end of range before shifting high-low speed control.

For complete operating instructions refer to Operator's Manual.



STARTING: Disengage header drive. Move ground speed lever to N. Lock steering wheel. Turn key.

STOPPING: Move ground speed lever to N. Lock steering wheel. Disengage header drive and stop engine.

TOWING: Disengage wheel drives by reversing disc at center of wheel.

* 109844

IN CAB #109844



BELOW DOOR HANDLE #32744

⚠ WARNING



PREVENT SERIOUS BODILY INJURY CAUSED BY:

- EXPLOSIVE BATTERY GASES. Keep sparks and flames away from the battery. Refer to Operator's Manual for battery boosting and charging procedures.
- CORROSIVE AND POISONOUS BATTERY ACID. Acid can severely burn your body and clothing.

FRONT OF PLATFORM #110989

⚠ CAUTION

To avoid injury or death from improper or unsafe machine operation:

1. Read the Operator's Manual, and follow all safety instructions.
2. If you do not have a Manual, obtain one from your dealer.
3. Do not allow untrained persons to operate the machine.
4. Review safety instructions with all operators annually.
5. Ensure that all safety signs are installed and legible.
6. Make certain everyone is clear of machine before starting engine and during operation.
7. Keep riders off the machine.
8. Keep all shields in place, and stay clear of moving parts.
9. Disengage header drive, put transmission in neutral and wait for all movement to stop before leaving operator's position.
10. Shut off engine and remove key from ignition before servicing, adjusting, lubricating, cleaning, or unplugging machine.
11. Engage locks to prevent lowering of header or reel before servicing in the raised position.
12. Use slow moving vehicle emblem and flashing warning lights when operating on roadways unless prohibited by law.



--- 098612

BEHIND DOOR ON SILL #109843

SAFETY

Safety Sign Locations (continued)

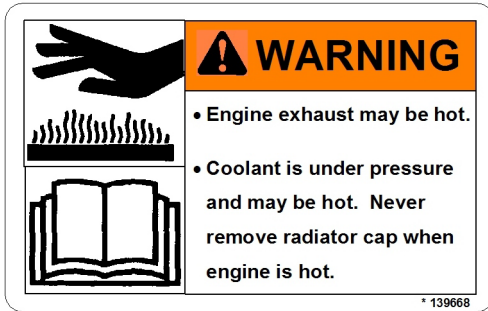

ON COOLER TOP DOOR / EXHAUST COVER #139668

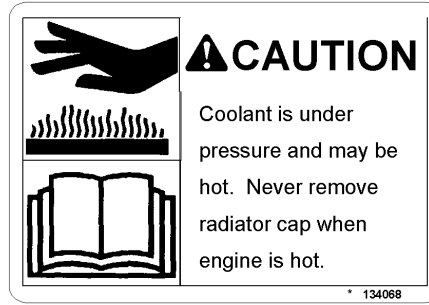

ON FAN SHROUD #134068

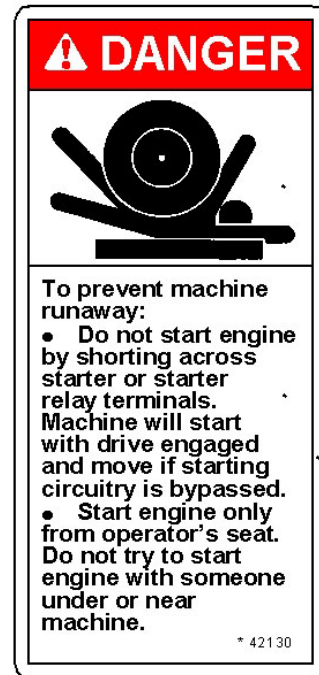
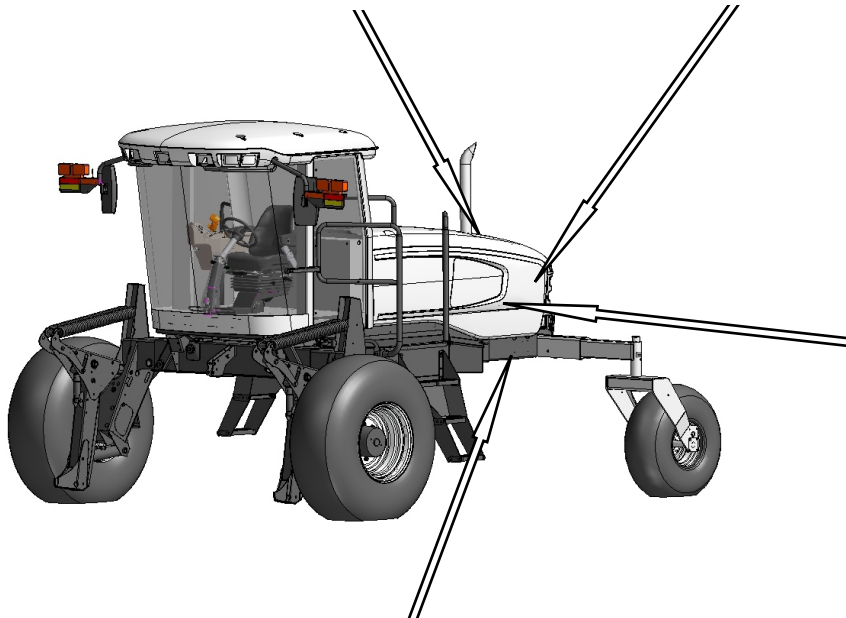

ON FRAME #42130



ON FRAME #110986

SAFETY

Safety Sign Locations (continued)



ON FRAME #110986

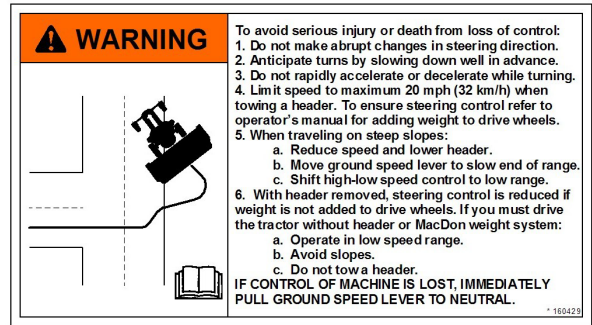

ON DRINK COOLER #160429

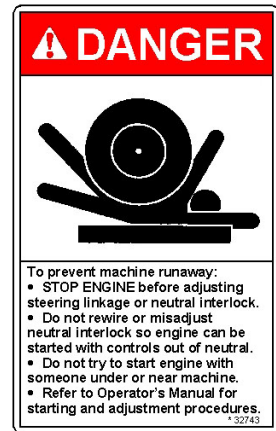
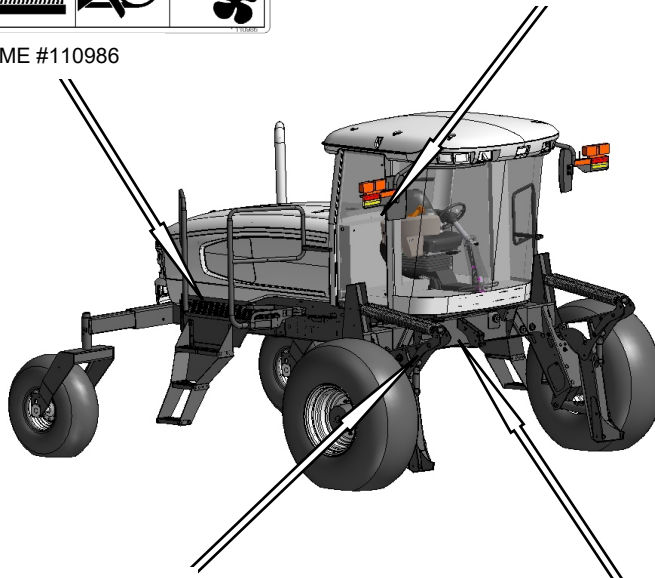

INSIDE FRAME #32743

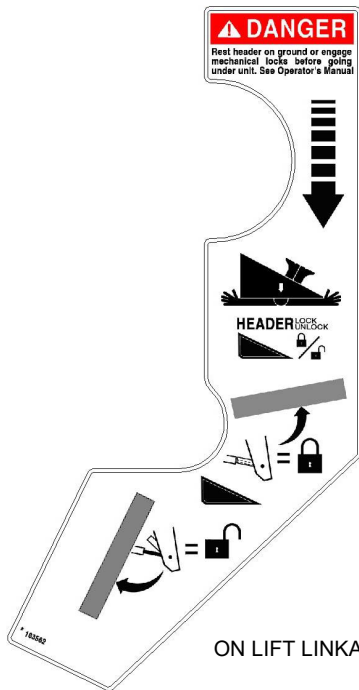

ON LIFT LINKAGE #163562

SAFETY

3.4 GENERAL SAFETY



CAUTION

The following are general farm safety precautions that should be part of your operating procedure for all types of machinery.

Protect yourself.

- When assembling, operating and servicing machinery, wear all the protective clothing and personal safety devices that **COULD** be necessary for the job at hand. Don't take chances.

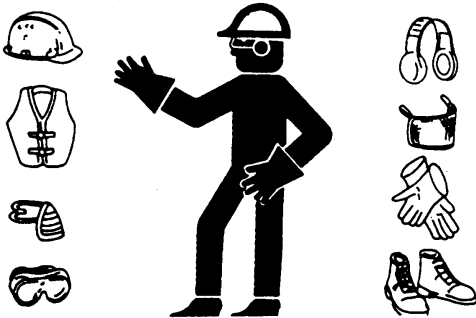

- You may need:
 - a hard hat.
 - protective shoes with slip resistant soles.
 - protective glasses or goggles.
 - heavy gloves.
 - wet weather gear.
 - respirator or filter mask.



- hearing protection. Be aware that prolonged exposure to loud noise can cause impairment or loss of hearing. Wearing a suitable hearing protective device such as ear muffs (A) or ear plugs (B) protects against objectionable or loud noises.



- Provide a first-aid kit for use in case of emergencies.
- Keep a fire extinguisher on the machine. Be sure the extinguisher is properly maintained and be familiar with its proper use.
- Keep young children away from machinery at all times.
- Be aware that accidents often happen when the operator is tired or in a hurry to get finished. Take the time to consider the safest way. Never ignore warning signs of fatigue.
- Wear close-fitting clothing and cover long hair. Never wear dangling items such as scarves or bracelets.
- Keep hands, feet, clothing and hair away from moving parts. Never attempt to clear obstructions or objects from a machine while the engine is running.

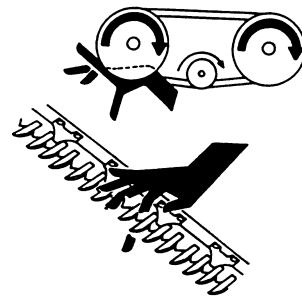

- Keep all shields in place. Never alter or remove safety equipment. Make sure driveline guards can rotate independently of the shaft and can telescope freely.
- Use only service and repair parts made or approved by the equipment manufacturer. Substituted parts may not meet strength, design, or safety requirements.

(continued next page)

SAFETY

- Do not modify the machine. Unauthorized modifications may impair the function and/or safety and affect machine life.
- Stop engine and remove key from ignition before leaving operator's seat for any reason. A child or even a pet could engage an idling machine.



- Keep the area used for servicing machinery clean and dry. Wet or oily floors are slippery. Wet spots can be dangerous when working with electrical equipment. Be sure all electrical outlets and tools are properly grounded.
- Use adequate light for the job at hand.
- Keep machinery clean. Straw and chaff on a hot engine are a fire hazard. Do not allow oil or grease to accumulate on service platforms, ladders or controls. Clean machines before storage.
- Never use gasoline, naphtha or any volatile material for cleaning purposes. These materials may be toxic and/or flammable.
- When storing machinery, cover sharp or extending components to prevent injury from accidental contact.

DEFINITIONS

4 PRODUCT DESCRIPTION

4.1 DEFINITIONS

The following terms/abbreviations may be used in this manual:

| TERM | DEFINITION |
|--------------------------------------|--|
| API | American Petroleum Institute |
| APT | Articulating Power Tongue |
| ASTM | American Society Of Testing and Materials |
| Cab-Forward | Windrower operation with the operator and cab facing in the direction of travel. |
| CDM | Cab Display Module |
| Center Link | A hydraulic cylinder or turnbuckle type link between the header and the machine that tilts the header. |
| DWA | Double Windrow Attachment |
| ECM | Engine Control Module. |
| Engine-Forward | Windrower operation with the operator and engine facing in the direction of travel. |
| GSL | Ground Speed Lever |
| Header | A machine that cuts and lays crop into a windrow, and is attached to a self-propelled windrower. |
| ISC | Intermediate Speed Control. |
| Mower Conditioner | A machine that cuts and conditions hay, and is pulled by an Ag tractor. |
| PTO | Power Take-Off |
| SAE | Society Of Automotive Engineers |
| Self-Propelled Windrower (SP) | Self-propelled machine consisting of a power unit with a header and/or conditioner. |
| Tractor | Ag type tractor. |
| Truck | A four-wheel highway/road vehicle weighing no less than 7500 lb (3400 kg). |
| Windrower | Power unit of a self-propelled header. |
| WCM | Windrower Control Module |

PRODUCT DESCRIPTION

4.2 SPECIFICATIONS

| ENGINE | | | | |
|--------------------------|------------------------|---|--------------------|-------------|
| Type | | Cummins QSB-6.7L 6 Cylinder Turbo Diesel. B20 Bio-Diesel Approved. | | |
| Displacement | | 409 cu.in. (6.7 L) | | |
| Power | Rated | 220 hp (164 kW) @ 2200 rpm | | |
| | Peak | 230 hp (172 kW) @ 2000 rpm | | |
| Bore | | 4.21 in. (107 mm) | | |
| Stroke | | 4.88 in. (124 mm) | | |
| Maximum RPM (no load) | | 2250-2340 | | |
| Idle RPM | | 1075-1150 | | |
| ELECTRICAL SYSTEM | | | | |
| Recommended Battery (2) | | 12 Volt, Min. 750CCA, Max Dim – 13x6.81 x9.43 in. (334x188x232 mm). Group Rating 29H or 31A. Heavy Duty/Off Road/Vibration Resistant. | | |
| Alternator | | 130 amp | | |
| Starter | | Wet Type | | |
| Working Lights | | 11 | | |
| TRACTION DRIVE | | | | |
| Type | | Hydrostatic, 3 Speed Electric Shift | | |
| Speed | Field (Cab Fwd) | Lo Range 0-11 mph (18 km/h) Mid Range 0-16 mph (26 km/h) | | |
| | Reverse (Cab Fwd) | 6 mph (9.6 km/h) | | |
| | Transport (Engine Fwd) | High Range 0-23 mph (37 km/h) | | |
| Transmission | Type | 2 Piston Pumps – 1 per Drive Wheel. | | |
| | Displacement | 2.65 cu.in. (44 cc) | | |
| | Flow | 40 U.S. gpm (167 L/min) | | |
| Final Drive | Type | Planetary Gearbox | | |
| | Ratio | 30.06 : 1 | | |
| Wheel Motor Displacement | Lo Range | 4.15 cu.in. (68 cc) | | |
| | Mid Range | 3.01 cu.in. (50 cc) | | |
| | Hi Range | 1.93 cu.in. (32 cc) | | |
| SYSTEM CAPACITIES | | | | |
| Fuel Tank | | 97 U.S. Gallons (367 L) | | |
| Cooling | | 7.9 U.S. Gallons (30 L) | | |
| Hydraulic Reservoir | | 17.2 U.S. Gallons (65 L) | | |
| HEADER DRIVE | | | | |
| Type | | Hydraulic, Electrical Displacement Control | | |
| Displacement | | Piston Pump A – 6.44 cu.in. (105.5 cc.), Gear Pumps B & C – 1.02 cu.in. (16.7 cc.) | | |
| Flow | | Piston Pump A – 72 gpm (0-273 L/min), Gear Pumps B & C – 12 gpm (45 L/min) | | |
| Max Pressure | | Piston Pump | Gear Pump B | Gear Pump C |
| | Disc Drive | 6000 psi (414 bar) | --- | --- |
| | Knife Drive | 4000 psi (276 bar) | --- | --- |
| | Reel Drive | 3200 psi (221 bar) | --- | --- |
| | DWA Drive | --- | 2600 (179) | --- |
| | Conveyor | --- | --- | 2600 (179) |
| | Supercharge | --- | 300 psi (20.7 bar) | |

(continued next page)

PRODUCT DESCRIPTION

| HEADER LIFT/TILT | | |
|----------------------------|----------------------------------|--|
| | Type | Hydraulic Double Acting Cylinders. Tilt – Hydraulic Positioning, Optional Mechanical Link |
| Gear Pump | Displacement | 1.02 cu.in. (16.7 cc) |
| | Flow | 12 U.S. gpm (45 L/min) |
| | System Pressure (Relief/Max) | 2500 psi (172 bar) |
| HEADER FLOTATION | | |
| | Primary Adjustment | Manual, External, Draw-Bolt With Springs (1 per side). One Inner Booster Spring On Left Side. |
| | Fine Adjustment | Hydraulic, In-Cab Switch |
| | Automatic | Hydraulic, 3 Programmable Settings For All Headers (Deck Shift Compensation On Draper Headers) |
| CAB | | |
| | Type | Spring/Shock Suspension |
| Dimensions | Width | 63 in. (1600 mm) |
| | Depth | 68.3 in. (1735 mm) (at top of window) |
| | Height | 64.6 in. (1640 mm) |
| | Volume | 125 cu.ft. (3540 L) |
| Seat | Driver | Adjustable Air-Ride Suspension, Seat Belt |
| | Training | Folding, Cab Mounted, Seat Belt |
| Windshield Wiper | Front | 31.5 in. (800 mm) Blade |
| | Rear | 22 in. (560 mm) Blade |
| | Heater | 24,000 Btu/h (7038 W) |
| | Air Conditioning | 28,280 Btu/h (8288 W) |
| | Electrical Outlets | One Live, Two On Ignition, One Live/Keyed |
| | Mirrors | One Inside (Transport), Two Outside (Field) |
| | Radio | Two Speakers and Antenna Factory Installed. Radio Dealer Installed |
| SYSTEM MONITORING | | |
| | Speeds | Ground (mph or km/h), Engine (rpm), Knife (spm), Disc (rpm), Reel (rpm or mph/km/h), Conveyor (Ref. No.) |
| | Header | Height, Angle, Float, Header Drive Load Gauge |
| TIRE OPTIONS | | |
| Size | Drive | 18.4 – 26 Bar, 18.4 – 26 Turf, 600-65 R28 Bar, 23.1 – 26 Turf, 580/70R26 Turf |
| | Rear | 7.5 – 16SL Single Rib, 10 - 16 Front Steer Tire 16.5L – 16.1 Rib Implement Flotation, Forked Caster |
| Pressure | Drive | Bar – 32 psi (221 kPa), Turf – 20 psi (138 kPa) |
| | Rear | 10 psi (69 kPa) |
| FRAME AND STRUCTURE | | |
| | Dimensions | Refer to Section 4.3, Windrower Dimensions |
| | Frame to Ground (Crop Clearance) | 45.7 in. (1160 mm) |
| Weight | Base | 9920 lb. (4500 kg) |
| | Max GVW | 21,500 (9750 kg) |
| | Max CGVW | 23,100 lb (10,480 kg) |
| | NG Header Compatibility | A30-S & A40-D Auger, D50 Harvest Header, D60 Harvest Header Up To 40 Ft, R80 & R85 Rotary Disc |

NOTES: 1. Specifications and design are subject to change without notice or obligation to revise previously sold units.
2. Weights do not include options.

PRODUCT DESCRIPTION

4.3 WINDROWER DIMENSIONS

See Illustration on Next Page

| | WHEEL POSITION | TREAD | HUBS | CASTERS | TIRES | SHIPPING | WHEEL BASE Inch/mm | |
|---|----------------|------------|------------|------------|------------|------------|--------------------|------------|
| | | Inch/mm | Inch/mm | Inch/mm | Inch/mm | Inch/mm | CAB FWD | ENG FWD |
| DRIVE TIRES | | | | | | | | |
| 18.4 x 26 Bar & Turf Rims Inset | Inner/Outer | 123.1/3127 | 139.1/3532 | - | 142.2/3612 | 142.9/3630 | 158.3/4020 | 120.6/3064 |
| | Outer/Outer | 130.2/3307 | 146.1/3712 | | 149.3/3792 | | | |
| | Inner/Inner | 116/2947 | 131.9/3352 | | 135.1/3432 | | | |
| 18.4 x 26 Bar & Turf Rims Outset | Inner/Outer | 130.1/3305 | 139.1/3532 | - | 149.2/3790 | 142.9/3630 | 158.3/4020 | 120.6/3064 |
| | Outer/Outer | 137.2/3484 | 146.1/3712 | | 156.3/3970 | | | |
| | Inner/Inner | 123/3124 | 131.9/3352 | | 142.1/3610 | | | |
| 600/65R28 Radial Tire | Inner/Outer | 130.1/3305 | 139.1/3532 | - | 153.7/3904 | 142.9/3630 | 158.3/4020 | 120.6/3064 |
| | Outer/Outer | 137.2/3484 | 146.1/3712 | | 160.9/4084 | | | |
| | Inner/Inner | 123/3124 | 131.9/3352 | | 146.6/3724 | | | |
| 23.1-26 & 580/70R26 Turf Tires | Inner/Outer | 127.2/3230 | 139.1/3532 | - | 150/3810 | 142.9/3630 | 158.3/4020 | 120.6/3064 |
| | Outer/Outer | 134.2/3410 | 146.1/3712 | | 157.1/3990 | | | |
| | Inner/Inner | 120.1/3050 | 131.9/3352 | | 142.9/3630 | | | |
| CASTER TIRES | | | | | | | | |
| 7.5 - 16SL | Minimum | 96.4/2448 | - | 119.4/3032 | | | | |
| | Maximum | 135.7/3448 | - | 158.8/4032 | | | | |
| 10-16 Formed Caster | Minimum | 96.4/2448 | - | 119.4/3032 | | | | |
| | Maximum | 135.7/3448 | - | 158.8/4032 | | | | |
| 10 - 16 Forked Caster | Minimum | 96.4/2448 | - | 118.7/3014 | | | | |
| | Maximum | 135.7/3448 | - | 158.0/4014 | | | | |
| 16.5 x 16.1 | Minimum | 96.4/2448 | - | 118.7/3014 | | | | |
| | Maximum | 135.7/3448 | - | 158.0/4014 | | | | |

PRODUCT DESCRIPTION

WINDROWER DIMENSIONS (cont'd)

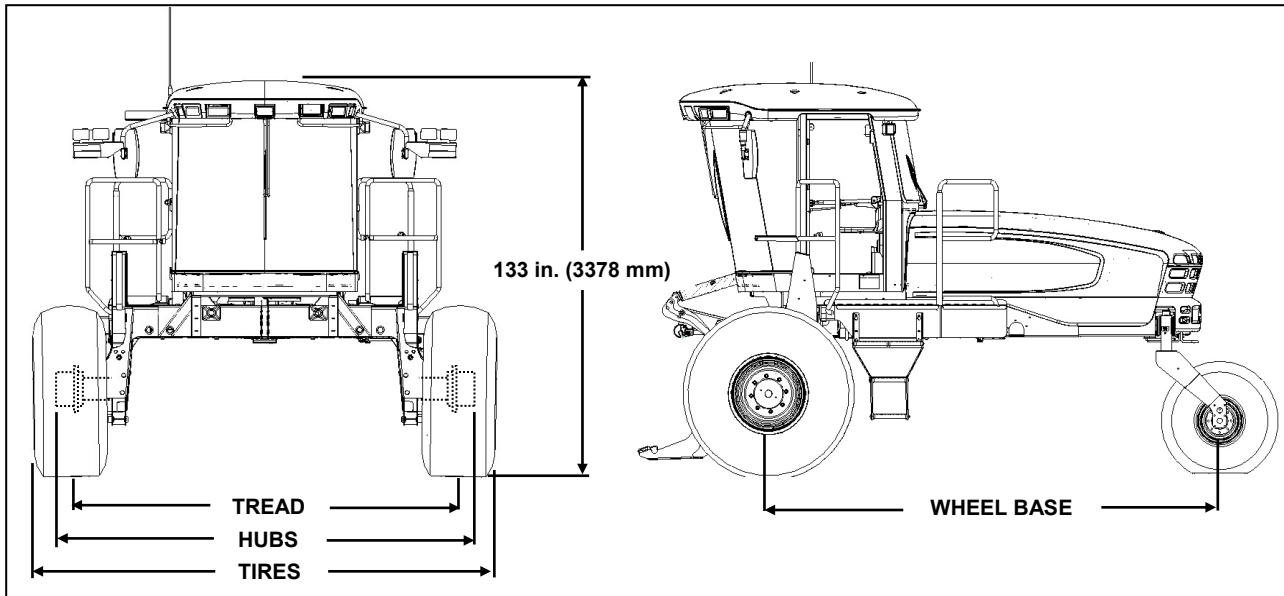

CAB FORWARD

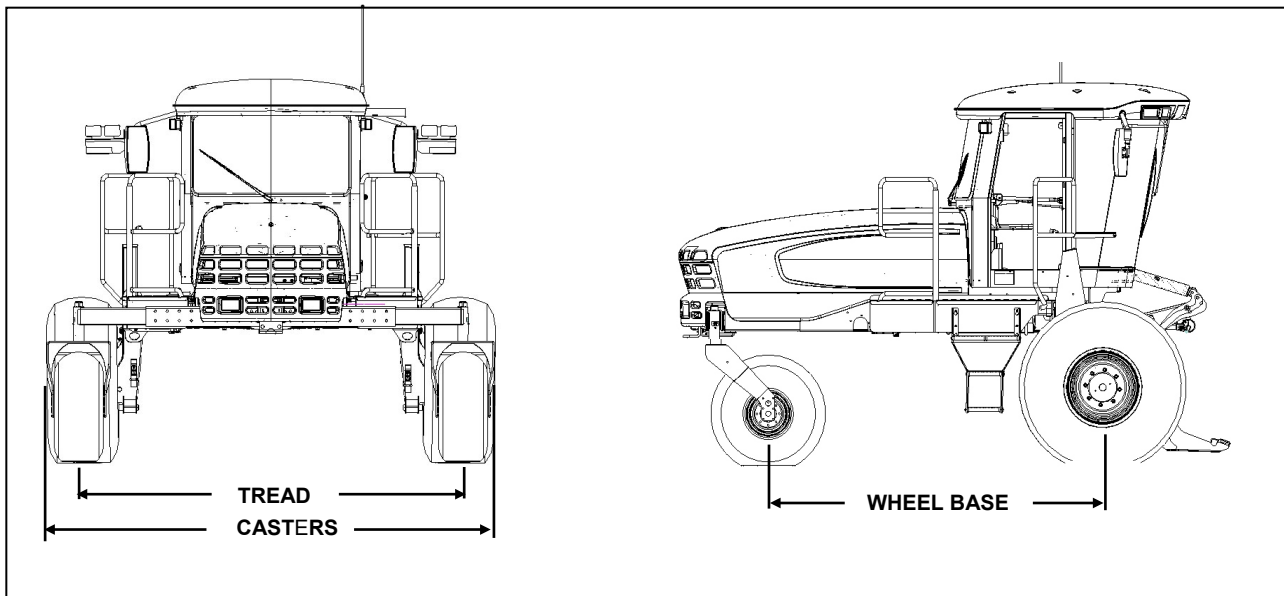

ENGINE-FORWARD

PRODUCT DESCRIPTION

4.4 COMPONENT IDENTIFICATION

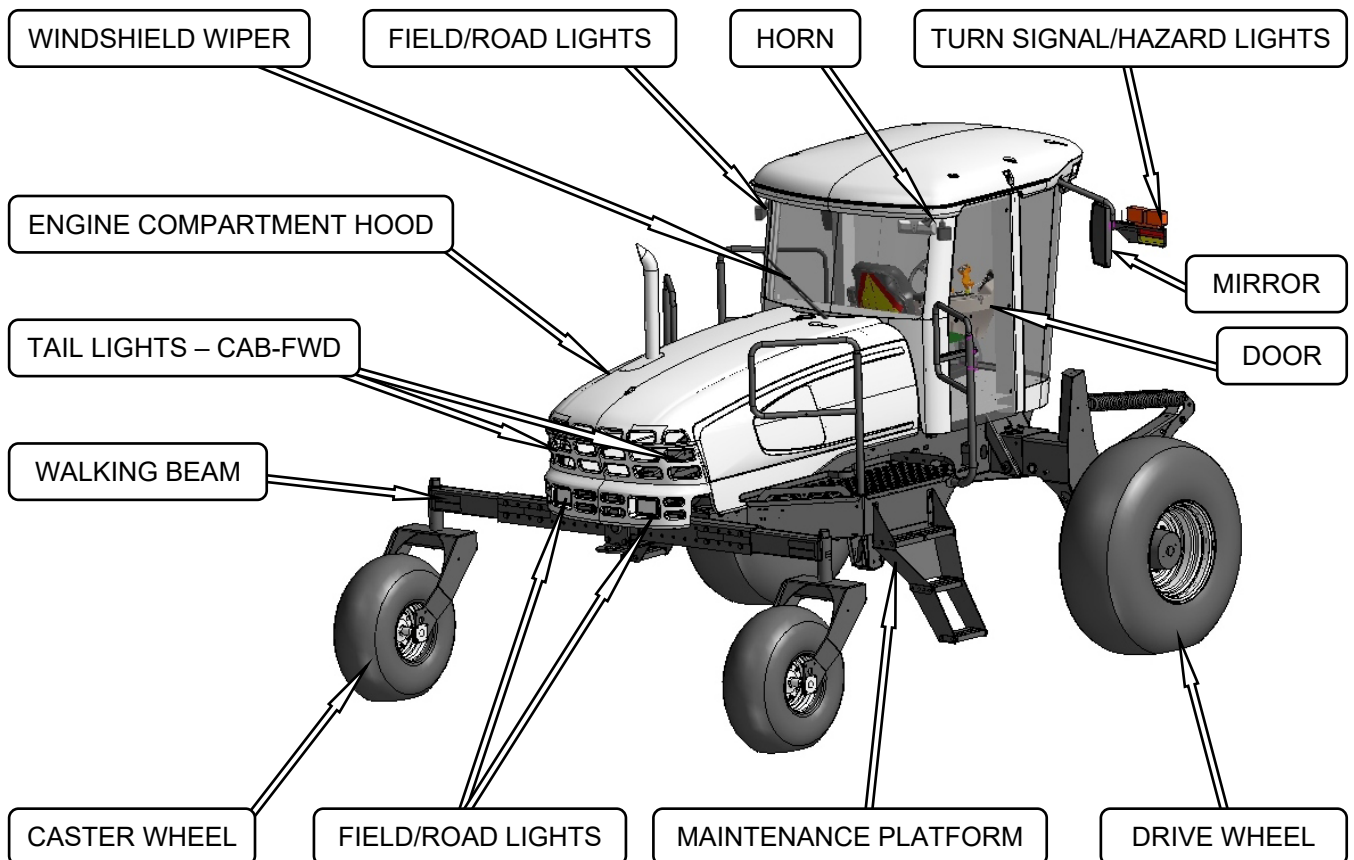
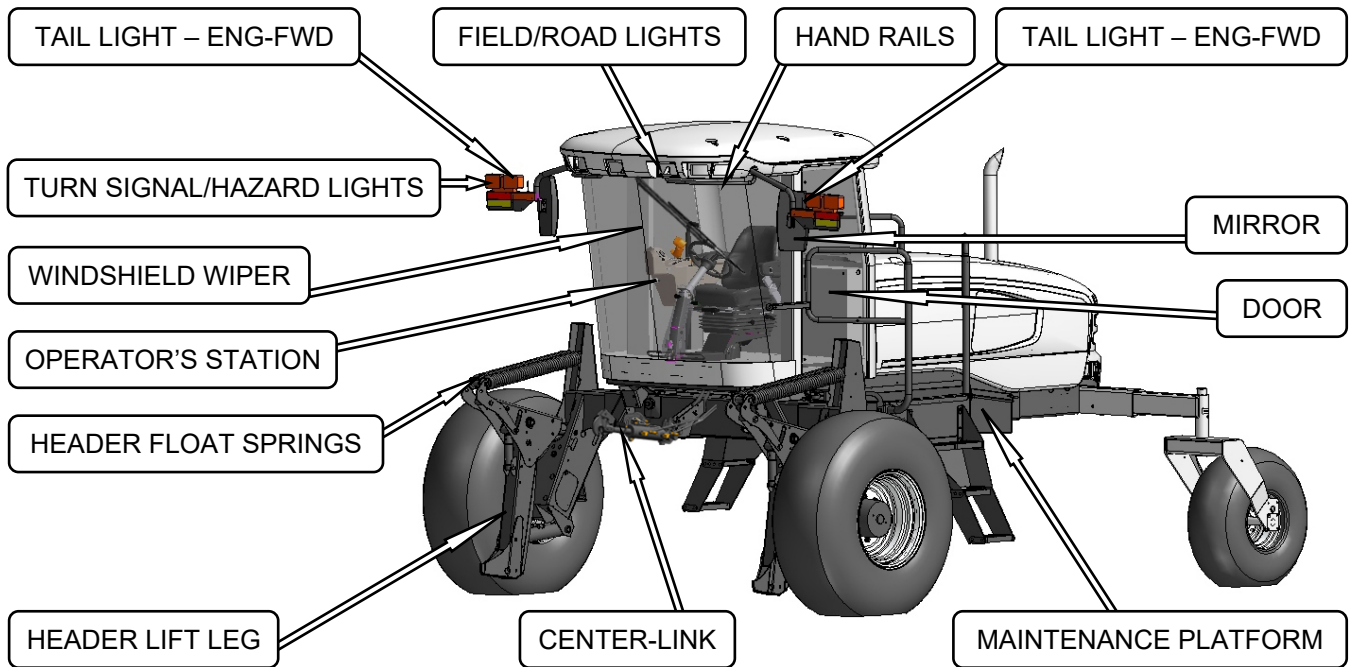

OPERATOR'S STATION

5 OPERATOR'S STATION

The operator's station is designed for operating the windrower in a cab-forward mode (working mode), or in an engine-forward mode (transport mode). The operator station, which includes the seat, console, and steering column, pivots 180° so that the operator maintains access to the windrower controls and gauges regardless of the direction of travel.

5.1 OPERATOR CONSOLE

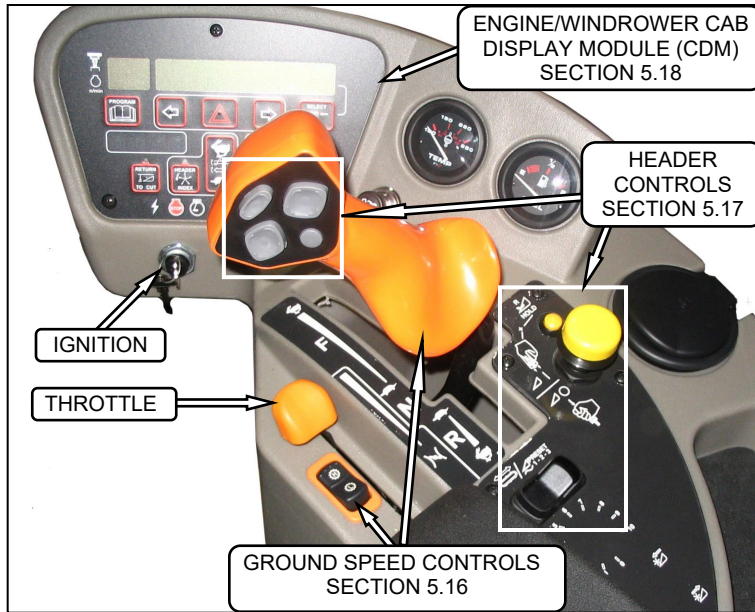

The console contains controls to operate the windrower as well as amenities for the operator.

The console position is adjustable to suit each particular operator as follows:

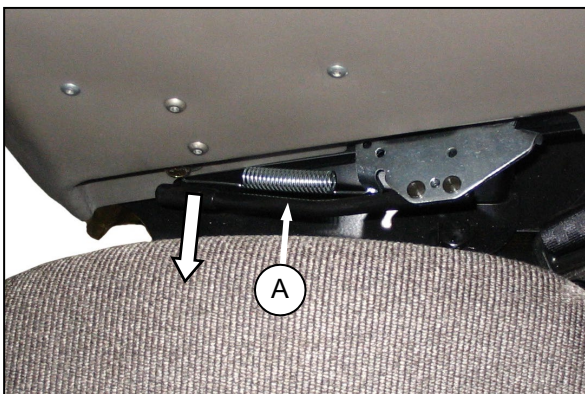

- a. To adjust fore/aft and height, pull lever (A) and slide console fore or aft to desired position. Release lever to lock console.

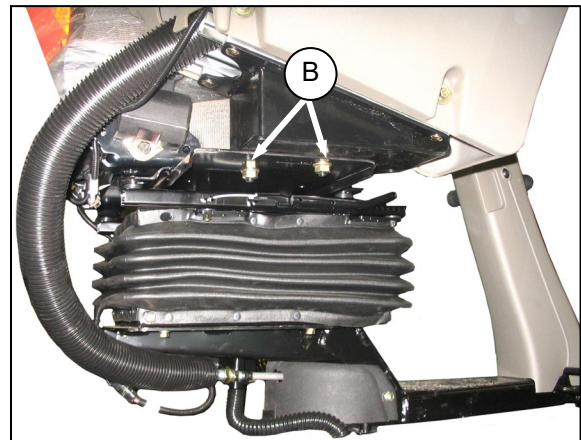

- b. To adjust only fore-aft, loosen nuts (B) under console and move as required.
- c. Tighten nuts.

OPERATOR'S STATION

5.2 OPERATOR PRESENCE

The Operator Presence System is a safety feature that is designed to deactivate or alarm selected systems when the operator is not seated at the operator's station. These systems include:

- Header Drive
- Engine and Transmission

5.2.1 HEADER DRIVE

- Requires the operator to be seated in the seat in order to engage the header drive.
- Power is maintained to the header drive for 5 seconds after the operator leaves the seat, and then the header shuts down.
- After the header has shutdown automatically, the header engage switch must be moved to "OFF" position and back to the "ON" position again to restart the header.

5.2.2 ENGINE AND TRANSMISSION

- The engine will not be allowed to start when the header drive switch is engaged.
- The engine will not be allowed to start when the transmission is not locked in neutral.
- The engine will shutdown when the windrower is moving at 5 mph (8 km/h) or less and the operator leaves the seat.
- If the operator leaves the seat and the transmission is not locked in neutral, after 5 seconds the lower display will flash "NOT IN NEUTRAL" accompanied by an alarm.
- When the seat is in between cab-forward and engine-forward positions, the engine will shut off if the transmission is not locked in the neutral position. The lower display will flash "LOCK SEAT BASE" until the seat base is locked into position.

5.3 SEAT ADJUSTMENTS

The operator's seat has several adjustments. Refer to the following illustration for the location and description of each adjustment.

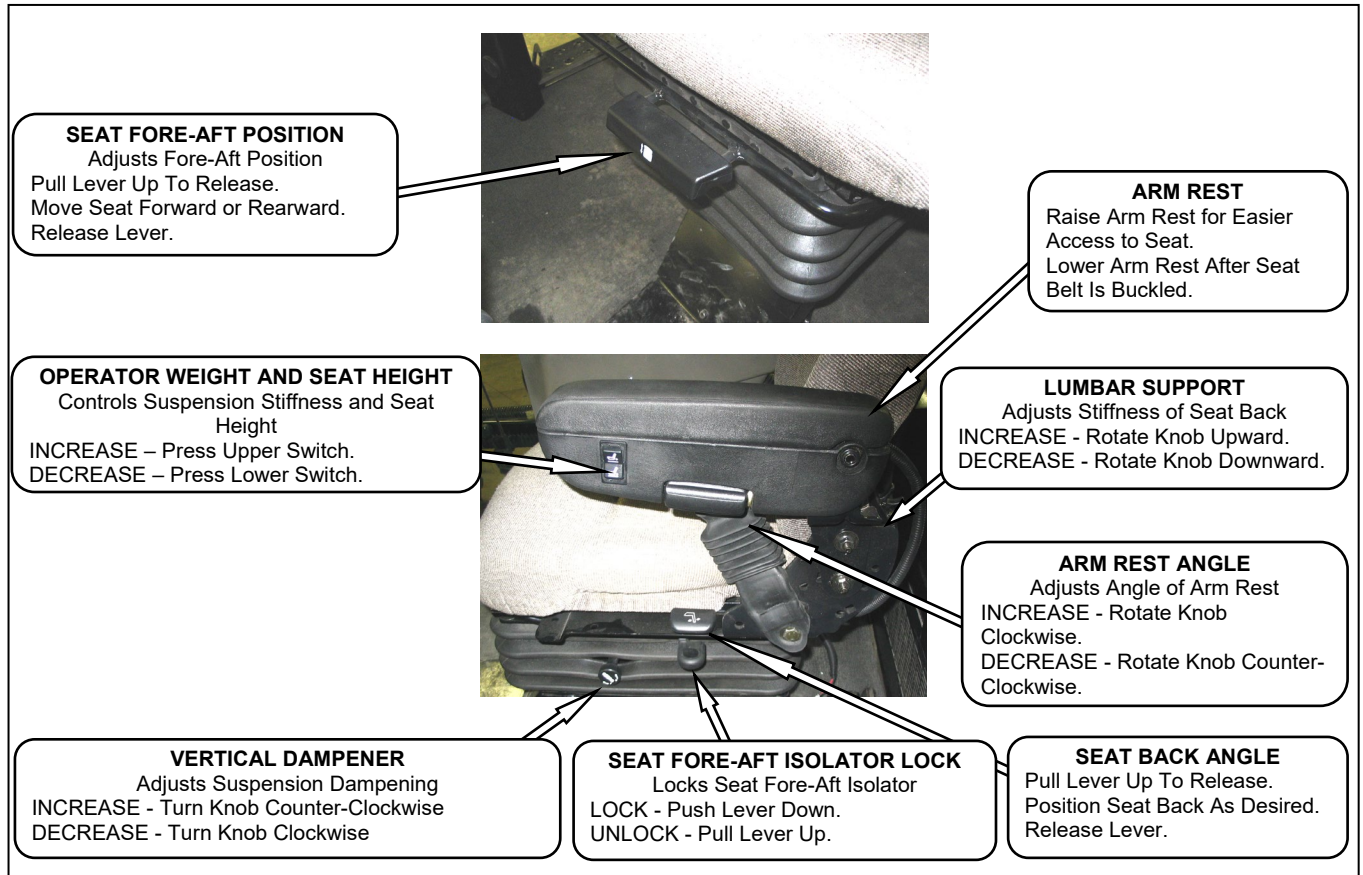

OPERATOR'S STATION

5.4 TRAINING SEAT

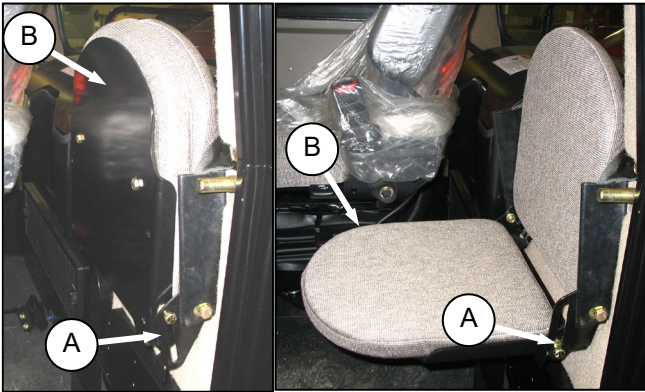

A wall mounted fold-up training seat complete with seat belt is provided for use as described below. To lower seat, lift latch (A) and lower seat (B). For storage, lift seat (B) and secure with latch (A).



WARNING

The training seat is provided for an experienced operator of the machine when a new operator is being trained.

The training seat is **NOT** intended as a **PASSENGER SEAT** or **FOR USE BY CHILDREN**.

USE THE SEAT BELT whenever operating the machine or riding as a trainer.

KEEP ALL OTHER RIDERS OFF THE MACHINE.

5.5 SEAT BELTS

The windrower is equipped with a seat belt on the Operator's and Trainer's seats.



WARNING

Before starting engine, securely fasten your seat belt and ensure trainer's seat belt is fastened if occupied. The seat belt can help insure your safety if it is used and maintained.

Never wear a seat belt loosely or with slack in the belt system.

Never wear the belt in a twisted condition or pinched between the seat structural members.

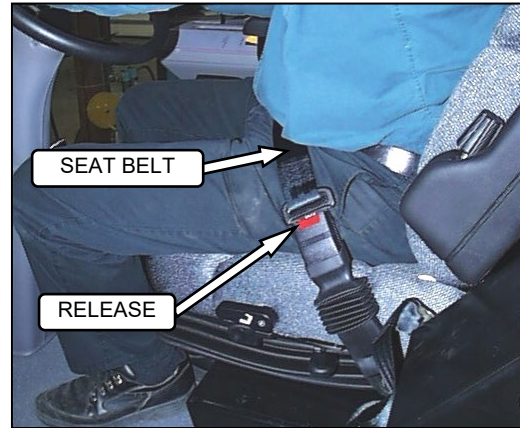

- To fasten seat belt, pull belt completely across your body. Push the metal eye into the buckle until it locks. Adjust the position of the belt as low on your body as possible.
- To release, push the red button in the end of the buckle and separate the buckle and metal eye.

5.6 STEERING COLUMN ADJUSTMENT

The steering column can be adjusted to suit each particular operator and for easier entry to and exit from the seat.

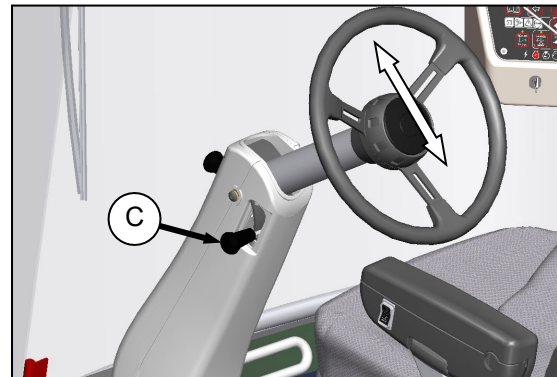

- Hold onto steering wheel, lift handle (C), and move steering wheel up or down to desired position.
- Release handle (C) to lock steering wheel position.

OPERATOR'S STATION

5.7 LIGHTS

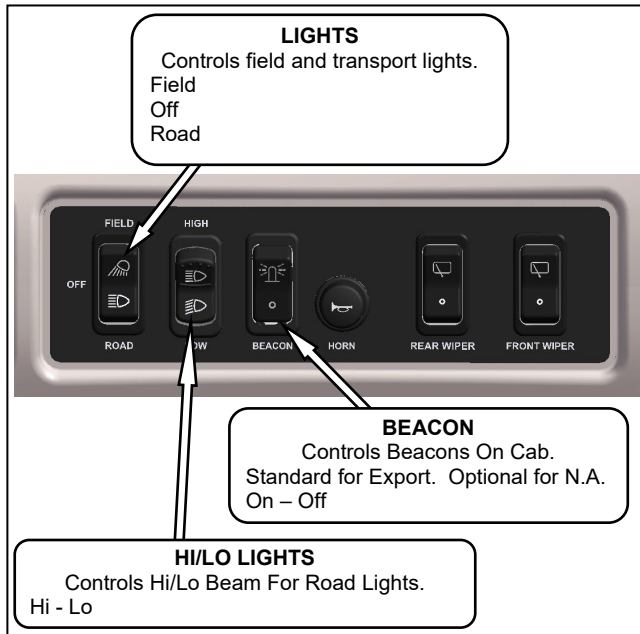

The field and transport light switches are located on a panel in the cab headliner. Refer to illustrations on following pages for location of lights.

The lighting is dependent upon the position of the operator's station, i.e. cab-forward mode or engine-forward mode. The position of the operator's station automatically determines the lighting.

IMPORTANT

Red and amber reflector tape is applied to be visible in both engine-forward and cab-forward modes.

5.7.1 CAB-FORWARD LIGHTING: FIELD

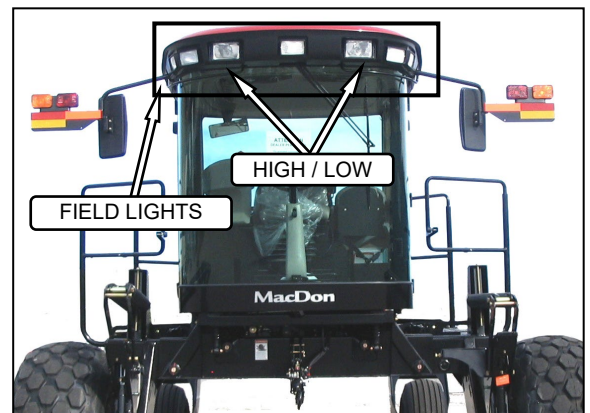

FRONT - CAB FWD

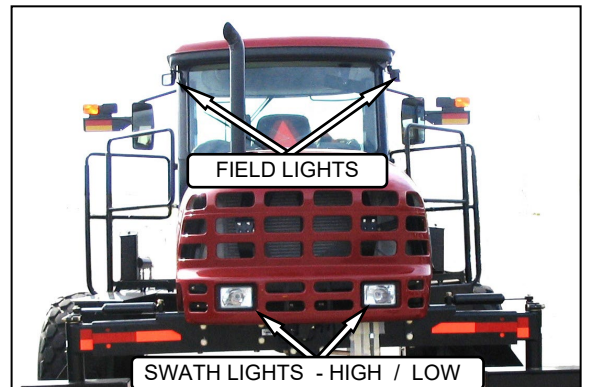

REAR - CAB FWD

OPERATOR'S STATION

5.7.2 ENGINE-FORWARD LIGHTING: ROAD

The following lights are on/functional when the switch is in the ROAD position. The hazard lights must be activated with the switch on the CDM when driving on the road.

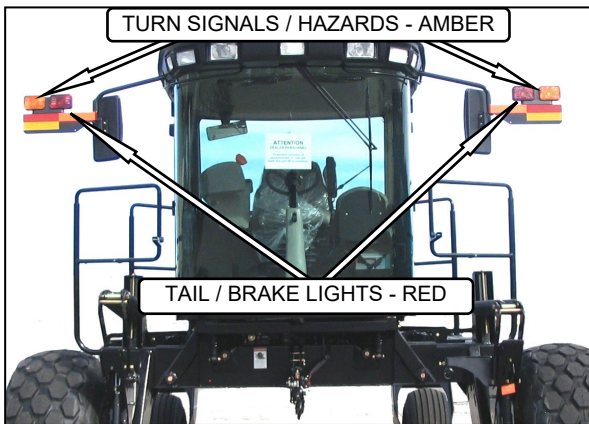

REAR - ENG FWD



FRONT - ENG FWD

5.7.3 CAB-FORWARD LIGHTING: ROAD (OPTIONAL)

If equipped, the following lights are functional when the switch is in the ROAD position. The hazard lights must be activated with the switch on the CDM when driving on the road.

IMPORTANT

Optional red tail lighting and marking kit must be installed so that road travel in the cab-forward mode complies with road travel regulations. See your MacDon dealer.

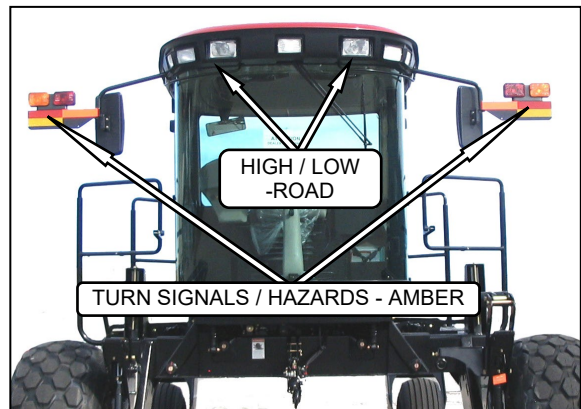

FRONT - CAB FWD

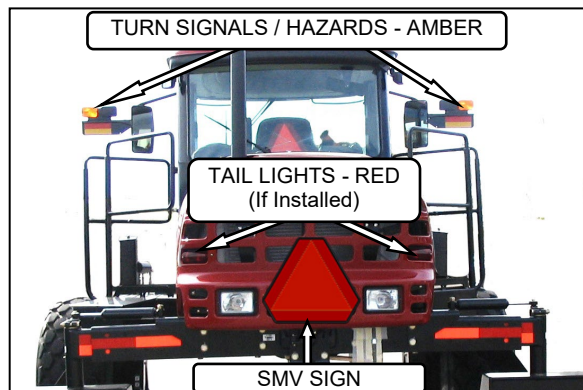

REAR - CAB FWD

OPERATOR'S STATION

5.7.4 BEACON LIGHTING: EXPORT (N.A. OPTIONAL)

The beacon lights are functional when the ignition and the beacon switches are on. The beacons must be used when driving on the road.



OPERATOR'S STATION

5.8 WINDSHIELD WIPERS

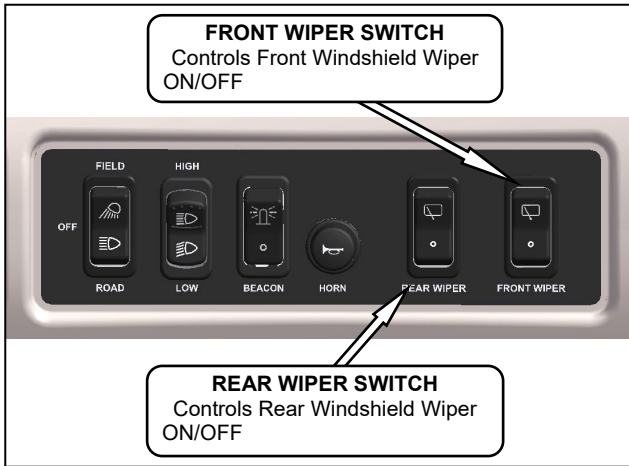

The windshield wiper controls are located in the cab headliner. The illustration above designates the controls as in the cab-forward mode.

5.9 REAR VIEW MIRRORS

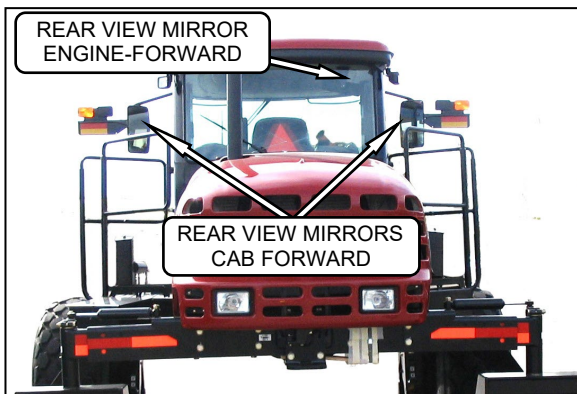

Two adjustable outside mounted mirrors provide rear view vision when the windrower is operated in the cab-forward mode. A single interior mounted mirror provides rear view vision in the engine-forward mode.

5.10 CAB TEMPERATURE

The cab environment is controlled by a climate-control system that provides clean air-conditioned or heated air for the operator. The heater/evaporator/blower assembly is located under the cab floorboard and is accessible from beneath the windrower.

5.10.1 HEATER SHUT-OFF VALVE

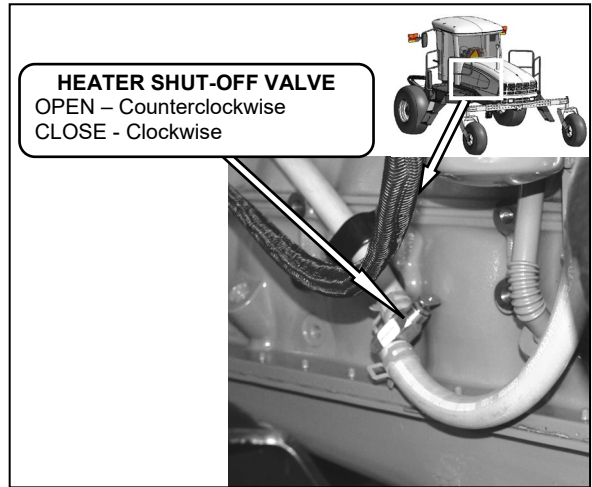

A shut-off valve at the engine allows the cab heater to be isolated from the engine coolant. The valve must be open to provide heat to the cab but for maximum cooling, the valve can be closed.

5.10.2 AIR DISTRIBUTION

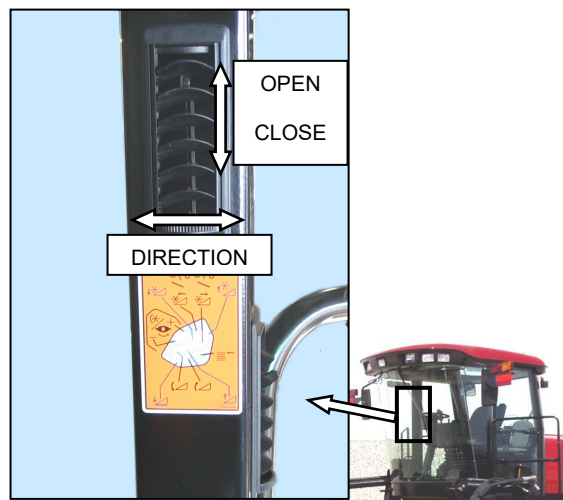

Cab air distribution is controlled through adjustable air vents. They are located in the cab posts to provide window and operator ventilation as shown in illustration.

OPERATOR'S STATION

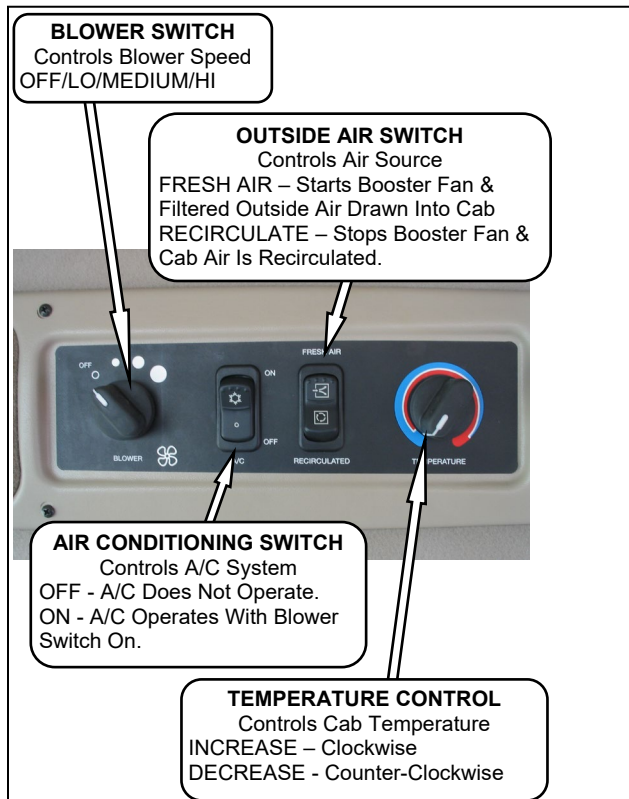

5.10.3 CONTROLS

IMPORTANT

To distribute the oil throughout the system, perform the following steps whenever the machine is first started after storage for more than one week:

- Turn blower switch to the first position, turn temperature control switch to maximum heating, and A/C control to "OFF".
- Start engine and operate at low idle until engine is warm.
- Click A/C switch from "OFF" to "ON" for one second, then back to "OFF" for 5 to 10 seconds. Repeat this step ten times.

5.10.4 A/C COMPRESSOR PROTECTION

The compressor is protected from excessively low and high pressures by two switches that shut down the compressor to prevent damage to the system.

- The LOW pressure switch opens when the pressure falls to 2-8 psi (14-55 kPa) and shuts down the compressor. When the pressure rises to 15-25 psi (103-172 kPa), the switch closes and allows the compressor to run.
- The HIGH pressure switch opens and stops the compressor when the pressure rises to 315-335 psi (2172-2310 kPa). When the pressure falls to 220-280 psi (1517-1930 kPa), the switch closes and allows the compressor to run.

If the air conditioning system is shut down by either switch, locate the source of the problem and correct it before operating the system.

5.11 INTERIOR LIGHTS

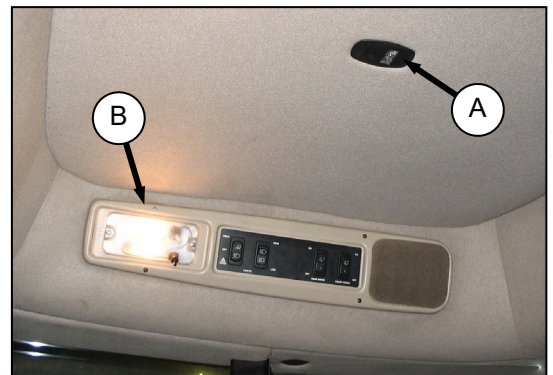

Two interior lights are installed in the cab headliner. A low intensity LED light (A) is located directly overhead to provide ambient lighting if desired, and functions only when the road/field light switch is on. An on-off switch is located on the light.

The other interior light (B) is located on the headliner switch panel and the push-on, push-off button is located on the light.

OPERATOR'S STATION

5.12 OPERATOR AMENITIES

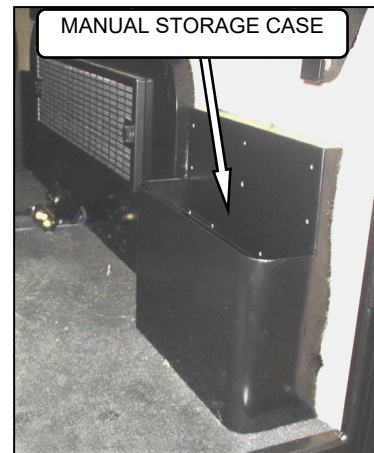
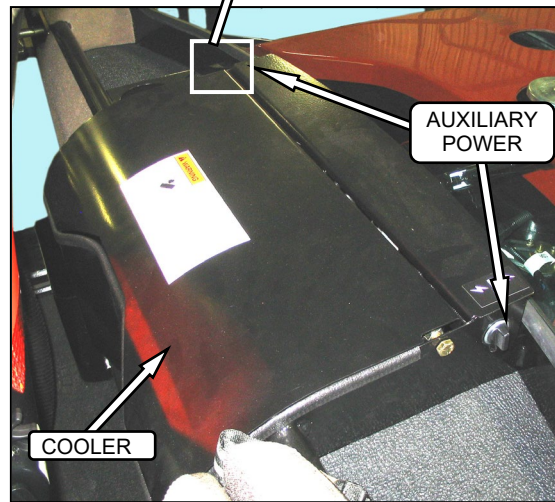
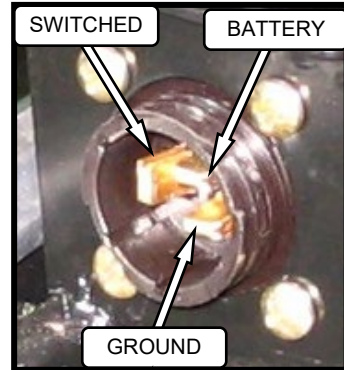
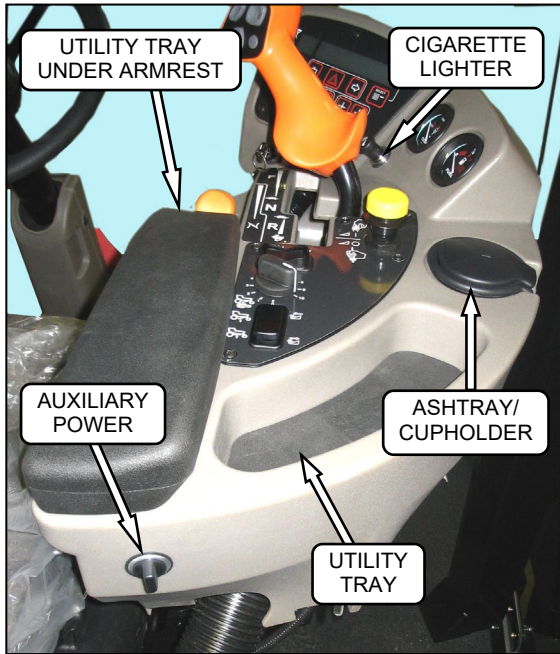

OPERATOR'S STATION

5.13 RADIOS

5.13.1 AM/FM RADIO

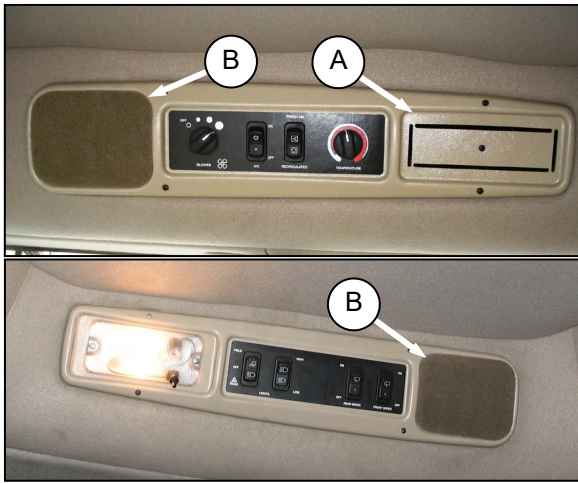

A radio is available as optional equipment from your dealer and a space (A) is provided in the cab headliner to accommodate the installation. Two pre-wired speakers (B) have been factory installed in the headliner. Refer to M150 & M200 Self-Propelled Windrower Unloading and Assembly Instruction for radio installation procedures. Operating instructions are supplied with the radio.

5.13.2 ANTENNA MOUNTING

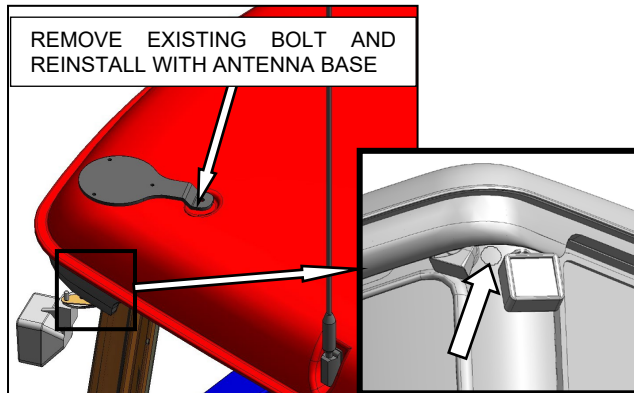

A roof mounted antenna base for installing a magnetic antenna is available as an option from your dealer. Order part #160288, or see illustration for part dimensions for a "homemade" version. It accommodates most CB, 2-way radio and satellite radio antennas. A knockout for the antenna lead is provided on the cab post

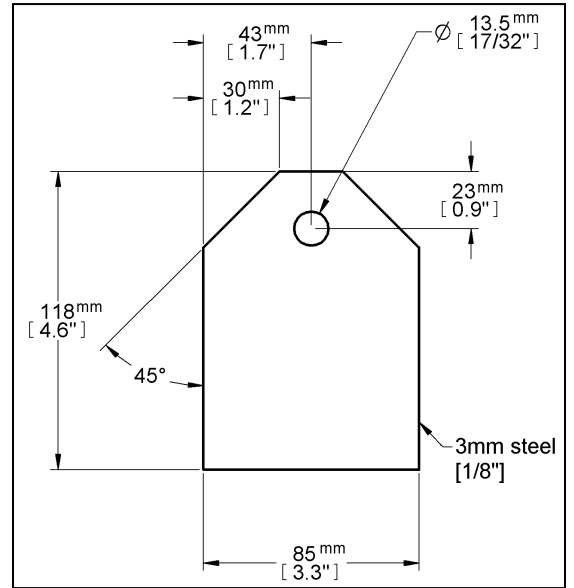

11 GA. OR 3.0 mm CQHRS

IMPORTANT

Antenna base can only be installed on the LH and RH rear cab roof bolts.

5.14 HORN



The horn is activated by pushing the button located on the panel in the headliner. The ignition switch must be on. Sound the horn three times prior to starting the engine.

OPERATOR'S STATION

5.15 ENGINE CONTROLS/GAUGES

All engine controls and gauges are conveniently located on the operator's console. Refer to the following illustration for the location and a description of each.



OPERATOR'S STATION

5.16 WINDROWER CONTROLS

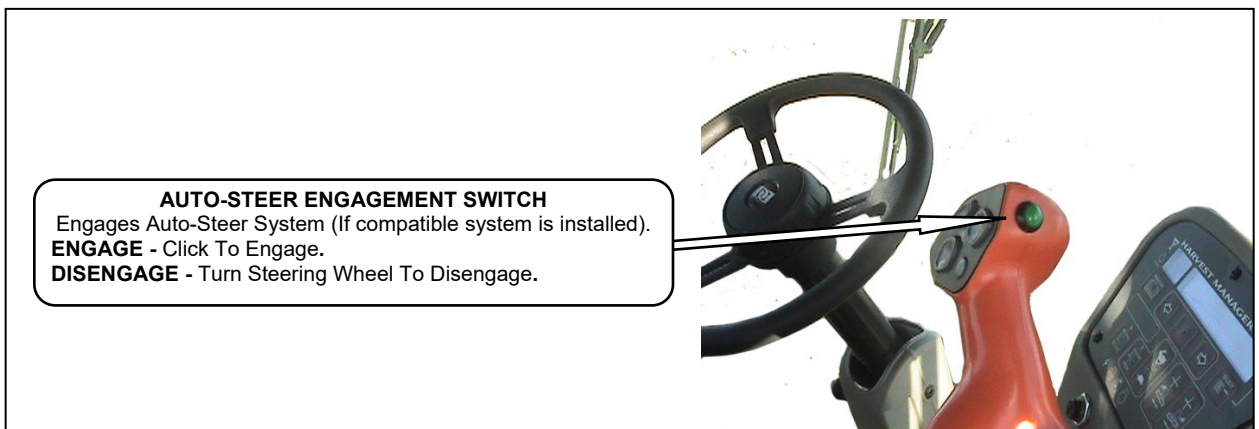

OPERATOR'S STATION

5.17 HEADER CONTROLS

All header controls are conveniently located on the operator's console and on the GSL handle.

NOTE

Some controls are optional equipment and may not be present in your unit. Some controls may be installed, but will be non-functional for certain headers.

Refer to specific header sections in this manual for detailed operating procedures of all header controls.

5.17.1 HEADER ENGAGE SWITCH



HEADER DRIVE
ENGAGE – Push Center & Pull Up
DISENGAGE – Push Down

Engages and disengages header drive.

IMPORTANT

Always move throttle lever back to idle before engaging header drive. Do not engage header with engine at full RPM.

5.17.2 HEADER DRIVE REVERSE BUTTON



HEADER REVERSE
ENGAGE – Push/Hold/Engage Header
DISENGAGE – Release Button

NOTE

The optional hydraulic reversing kit must be installed on draper headers with a conditioner and on auger headers. Rotary disc headers are factory equipped with the reverser.

OPERATOR'S STATION

5.17.3 GSL HEADER SWITCHES

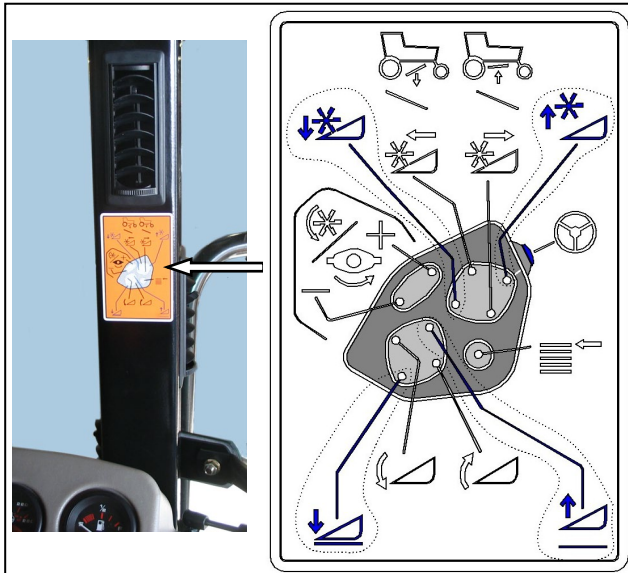

The GSL (A) contains switches for the header functions that are most often adjusted while in operation to suit changing crop conditions. All are momentary type switches. A decal that identifies the switch functions is located on the cab post above the operator's console.

5.17.3.1 Display Selector Switch



Selects and displays the settings in the CDM (B) top line read-out for each of the header controls.

- Press switch to scroll through settings.

5.17.3.2 Reel Position Switches

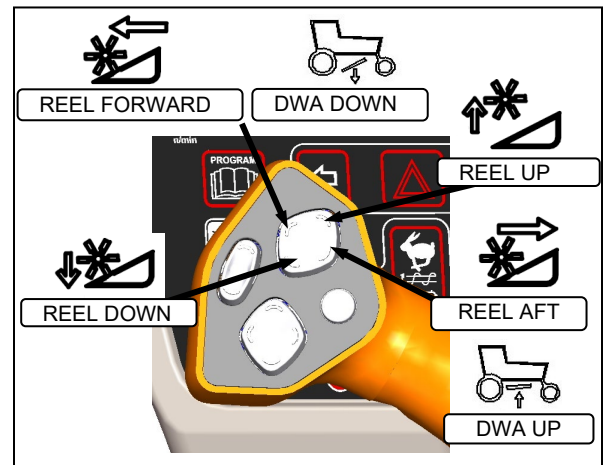

The reel position switches perform functions depending on CDM programming and on which header is attached:

- DWA Position on Draper and Auger Headers. See Section 6.4.7
- Reel Fore/Aft Position and Height on Draper Headers. See Sections 6.5.4 and 6.5.5.
- Center Link Assist Cylinder. See Sections 6.5.1, 6.6.1, or 6.7.1.

NOTE

Refer to the specific header section in this manual for detailed switch operating modes.

OPERATOR'S STATION

5.17.3.3 Header Position Switches

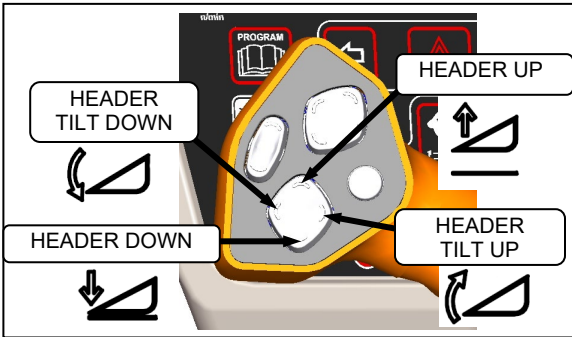

Press and hold switch at location shown to move header. Release switch at desired position.

NOTE

Refer to the specific header section in this manual for detailed switch operating modes.

5.17.3.4 Reel & Disc Speed Switches

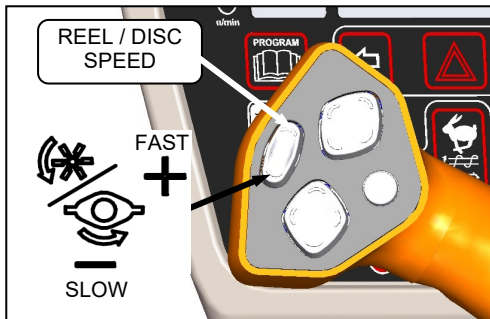

Press and hold switch at location shown to change reel or disc speed. Release switch at desired speed.

- *Auger Header*
A30 – Not applicable.

A40 - Auger speed is automatically maintained when reel speed is changed.

IMPORTANT

Reel speed on auger header must not exceed 85 rpm. Auger speed not to exceed 320 rpm.

- *Draper Header*
Reel speed is limited in INDEX HEADER SPEED mode.
- *Rotary Header*
Conditioner speed automatically adjusts when disc speed is changed.

5.17.4 CONSOLE HEADER SWITCHES

The operator's console contains switches for the following header functions.

5.17.4.1 Deck Shift/Float Preset Switch

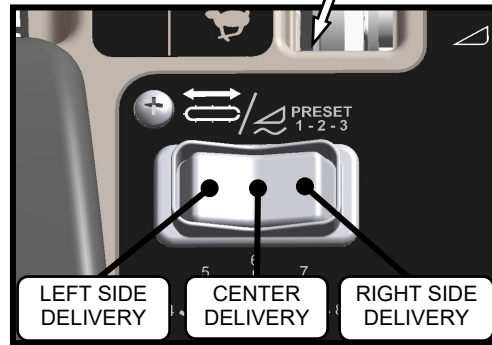

- *Draper Header with Deck Shift Option* - Controls deck shifting for double windrowing options with a draper header.

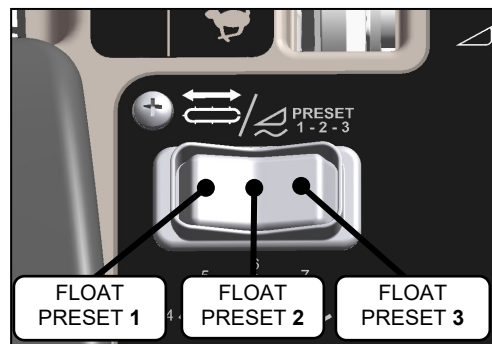

- *Draper Header with Fixed Decks/Auger Header/Rotary Header*
Selects pre-programmed header float settings. Refer to Section 6.4.2 Flotation, for instructions to preset the float.

NOTE

Refer to the specific header section in this manual for detailed switch operating modes.

OPERATOR'S STATION

5.18 CAB DISPLAY MODULE (CDM)

5.18.1 ENGINE AND WINDROWER FUNCTIONS

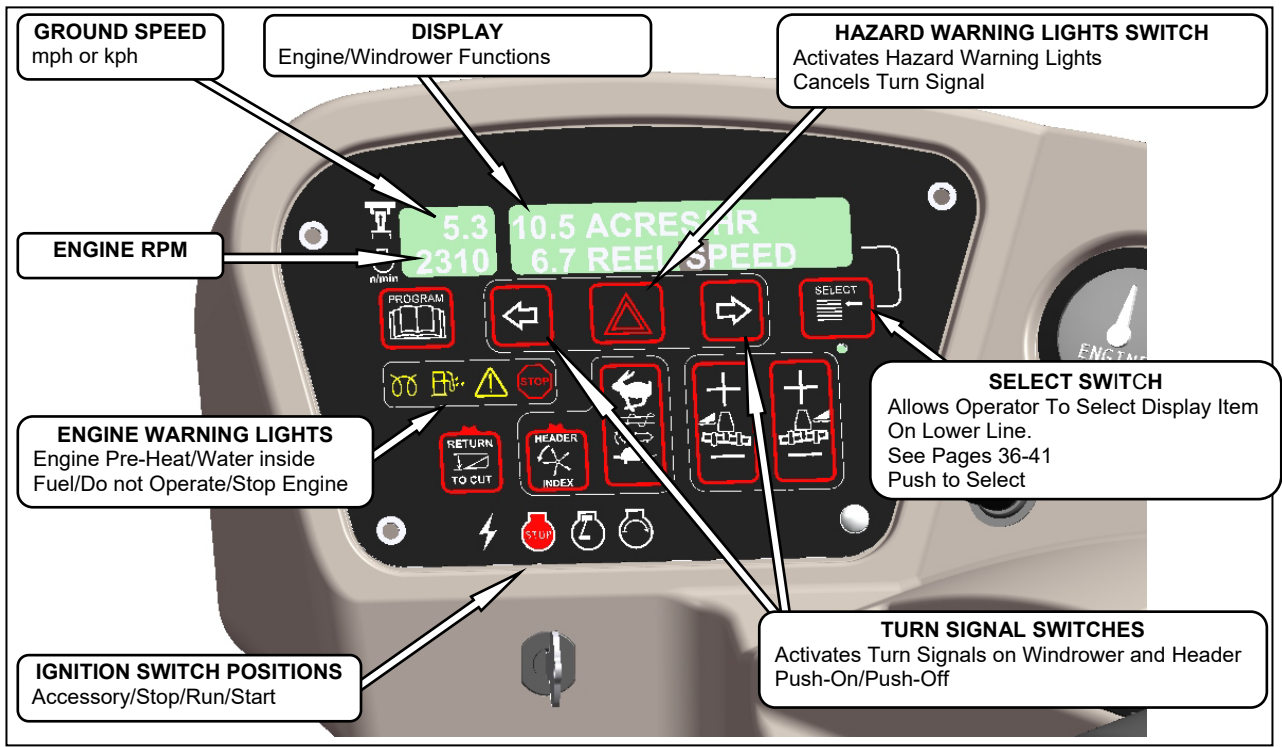

5.18.2 HEADER FUNCTIONS

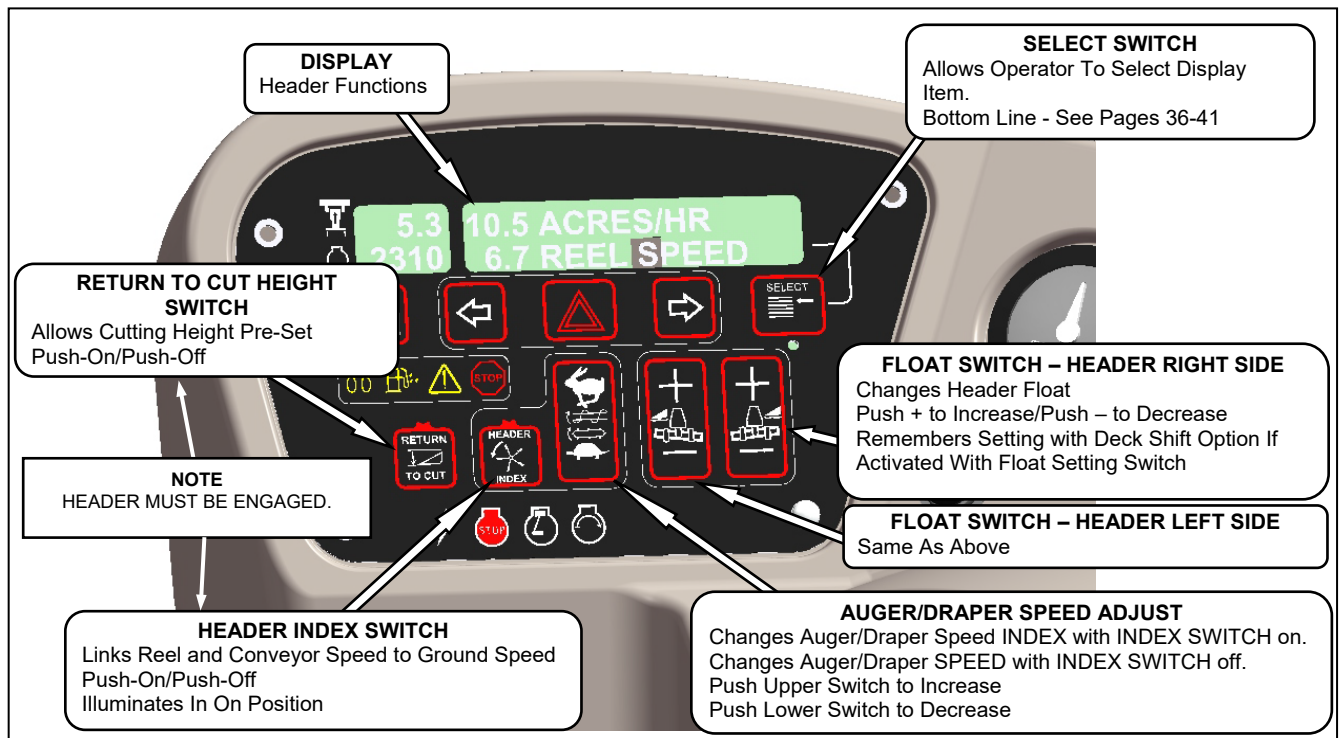

OPERATOR'S STATION

The information displayed in various operating modes is described in the following sections:

5.18.3 OPERATING SCREENS

The M205 windrower Cab Display Module (CDM) and the Windrower Control Module (WCM) provide information on several functions for the engine, header, and windrower.

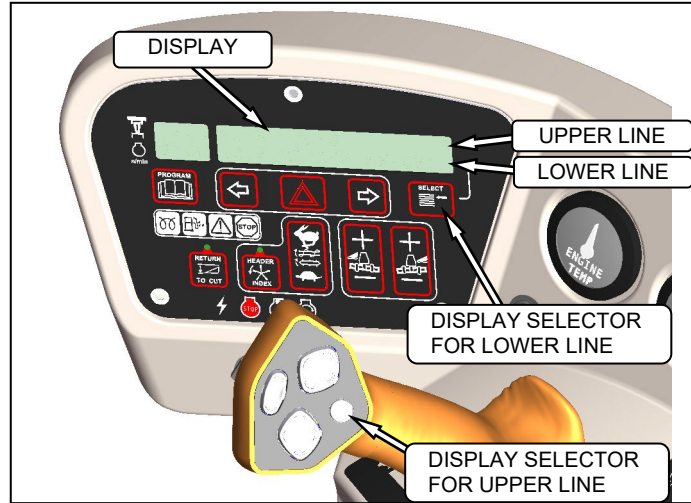

IGNITION ON - ENGINE NOT RUNNING

| DISPLAY (Upper Line)(2-3 Seconds) | DESCRIPTION |
|-----------------------------------|--|
| HEADER DISENGAGED | Indicates Header Engage Switch Is Off. |
| IN PARK | Indicates GSL In Neutral Detent. |

ENGINE-FORWARD - ENGINE RUNNING

(Scroll Through Display with CDM Switch or GSL Switch)

| DISPLAY | DESCRIPTION |
|---|---|
| ROAD GEAR (Upper Line) | Ground Speed Range Switch In High Range. |
| #####.# ENGINE HRS (Upper or Lower Line) | Total Engine Operating Time. |
| #####.# HEADER HRS (Upper or Lower Line) | Total Header Operating Time. |
| ##### TOTAL ACRES (Upper or Lower Line) ##### TOTAL HECT (if Metric) | Total Area Cut By Machine. |
| ##.# HEADER HEIGHT (Upper or Lower Line) | Distance Setting (00.0-10.0) Between Cutterbar & Ground. |
| ##.# HEADER ANGLE (Upper or Lower Line) | Angle Setting (00.0-10.0) Header Relative to Ground. |
| ### °C or F HYD OIL | Hydraulic Oil Temperature. |
| ##.# VOLTS (Upper or Lower Line) | Engine Electrical System Operating Voltage. |
| SCROLL (Lower Line) | Displays Above Items After 2-3 Seconds. Press SELECT to cancel. |

OPERATOR'S STATION
CAB-FORWARD - ENGINE RUNNING - HEADER DISENGAGED

(Scroll Through Display with CDM Switch or GSL Switch)

| DISPLAY (Lower or Upper Line) | DESCRIPTION |
|---|---|
| #####.# ENGINE HRS | Total Engine Operating Time. |
| #####.# HEADER HRS | Total Header Operating Time. |
| ###.# SUB ACRES ###.# SUB HECTARES (If Metric) | Area Cut Since Last Reset. To Reset, Display SUB ACRES On Lower Line and Hold Down Program Switch Until Display Resets (5-7 Seconds). |
| ##### TOTAL ACRES ##### TOTAL HECT (If Metric) | Total Area Cut By Machine. |
| ##.# HEADER HEIGHT | Distance Setting (00.0-10.0) Between Cutterbar & Ground. |
| ##.# HEADER ANGLE | Angle Setting (00.0-10.0) Header Relative to Ground. |
| ##.# L FLOAT R ##.# | Float Setting (0.0-10.0). |
| ### °C or F HYD OIL | Hydraulic Oil Temperature. |
| ##.# VOLTS | Engine Electrical System Operating Voltage. |
| SCROLL (Lower Line) | Displays Above Items After 2-3 Seconds. Press SELECT to cancel. |

OPERATOR'S STATION

CAB-FORWARD - ENGINE RUNNING - HEADER ENGAGED AUGER HEADER

(Scroll Through Display with CDM Switch or GSL Switch)

| DISPLAY (Lower or Upper Line) | DESCRIPTION |
|---|--|
| #####.# ENGINE HRS | Total Engine Operating Time. |
| #####.# HEADER HRS | Total Header Operating Time. |
| ##.# ACRES/HOUR ##.# HECTARES/HOUR (If Metric) | Actual Cutting Rate In Acres (Hectares)/Hour. |
| ###.# SUB ACRES ###.# SUB HECTARES (If Metric) | Area Cut Since Last Reset. To Reset, Display SUB ACRES On Lower Line and Hold Down Program Switch Until Display Resets (5-7 Seconds). |
| ##### TOTAL ACRES ##### TOTAL HECT (If Metric) | Total Area Cut By Machine. |
| ###.# REEL RPM ###.# REEL SENSOR (If Sensor Disabled) | Reel Rotational Speed. |
| ##.# AUGER SPEED | Auger Rotational Speed (4.7-9.9). |
| #### KNIFE SPEED #### KNIFE SENSOR (If Sensor Disabled) | Knife Speed In Strokes Per Minute. |
| ##.# HEADER HEIGHT ##.# HEIGHT SENSOR (If Sensor Disabled) | Distance Setting (00.0-10.0) Between Cutterbar & Ground. |
| ##.# HEADER ANGLE ##.# TILT SENSOR (If Sensor Disabled) | Angle Setting (00.0-10.0) Header Relative To Ground. |
| ##.# L FLOAT R ##.# FLOAT SENS DISABLED (If Sensor Disabled) | Left and Right Float Setting (0.0-10.0). |
| LOAD ■■■■■ #### (If Metric) ##### | Bar Graph Representing Hydraulic Operating Pressure. Full Scale Is Pre-Programmed Overload Pressure (2500-5000 psi). If Sensor Disabled, LOAD Does Not Display. See Note. |
| ### °C or F HYD OIL | Hydraulic Oil Temperature. |
| ##.# VOLTS | Engine Electrical System Operating Voltage. |
| SCROLL <i>SUB-MENU (Lower Line Only)</i> #### KNIFE SPEED ##.# HEADER HEIGHT LOAD ■■■■■■■■■■ #### | Displays Sub-Menu After 2-3 Seconds. Press SELECT to cancel. Scroll Through Sub-Menu Display with CDM Switch |

NOTE: The LOAD sensor to monitor knife/conditioner circuit pressure is factory installed. To monitor reel/auger circuit pressure, relocate sensor as per Instruction 169031 which is available through your dealer.

OPERATOR'S STATION
CAB-FORWARD - ENGINE RUNNING - HEADER ENGAGED
DRAPER HEADER - INDEX SWITCH OFF

(Scroll Through Display with CDM Switch or GSL Switch)

| DISPLAY (Lower or Upper Line) | DESCRIPTION |
|--|--|
| ##### ENGINE HRS | Total Engine Operating Time. |
| ##### HEADER HRS | Total Header Operating Time. |
| ##.# ACRES/HOUR ##.# HECTARES/HOUR (If Metric) | Actual Cutting Rate In Acres (Hectares)/Hour. |
| ###.# SUB ACRES ###.# SUB HECTARES (If Metric) | Area Cut Since Last Reset. To Reset, Display SUB ACRES On Lower Line and Hold Down Program Switch Until Display Resets (5-7 Seconds). |
| ##### TOTAL ACRES ##### TOTAL HECT (If Metric) | Total Area Cut By Machine. |
| ###.# REEL MPH ###.# REEL KPH (If Metric) ###.# REEL SENSOR (Sensor Disabled) | Reel Peripheral Speed. |
| ##.# DRAPER SPEED | Draper Speed (0.0-11.0). |
| ##### KNIFE SPEED ##### KNIFE SENSOR (Sensor Disabled) | Knife Speed In Strokes Per Minute. |
| ##.# HEADER HEIGHT ##.# HEIGHT SENSOR (Sensor Disabled) | Distance Setting (00.0-10.0) Between Cutterbar & Ground. |
| ##.# HEADER ANGLE ##.# TILT SENSOR (Sensor Disabled) | Angle Setting (00.0-10.0). Header Relative To Ground. |
| ##.# L FLOAT R ##.# | Left and Right Float Setting (0.0-10.0). |
| LOAD ■■■■■_____ #### (If Metric) ##### | Bar Graph Representing Hydraulic Operating Pressure. Full Scale Is Pre-Programmed Overload Pressure (2500-5000 psi). If Sensor Disabled, LOAD Does Not Display. See Note. |
| ### °C or F HYD OIL | Hydraulic Oil Temperature. |
| ##.# VOLTS | Engine Electrical System Operating Voltage. |
| SCROLL <i>SUB-MENU (Lower Line Only)</i> #### KNIFE SPEED ##.# HEADER HEIGHT LOAD ■■■■■■■■■■■■■■■■■■■■■■ #### ###.# REEL MPH ##.# DRAPER SPEED | Displays Sub-Menu After 2-3 Seconds. Press SELECT to cancel. Scroll Through Sub-Menu Display with CDM Switch |

NOTE: The LOAD sensor to monitor knife/conditioner circuit pressure is factory installed. To monitor reel/draper circuit pressure, relocate sensor as per Instruction 169031 which is available through your dealer.



OPERATOR'S STATION
CAB-FORWARD - ENGINE RUNNING - HEADER ENGAGED
ROTARY HEADER

(Scroll Through Display with CDM Switch or GSL Switch)

| DISPLAY (Lower or Upper Line) | DESCRIPTION |
|---|---|
| #####.# ENGINE HRS | Total Engine Operating Time. |
| #####.# HEADER HRS | Total Header Operating Time. |
| ##.# ACRES/HOUR ##.# HECTARES/HOUR (If Metric) | Actual Cutting Rate In Acres (Hectares)/Hour. |
| ###.# SUB ACRES ###.# SUB HECTARES (If Metric) | Area Cut Since Last Reset. To Reset, Display SUB ACRES On Lower Line and Hold Down Program Switch Until Display Resets (5-7 Seconds). |
| ##### TOTAL ACRES ##### TOTAL HECT (If Metric) | Total Area Cut By Machine. |
| #### DISC RPM ###.# REEL SENSOR (If Sensor Disabled) | Disc Rotational Speed. |
| ##.# HEADER HEIGHT ##.# HEIGHT SENSOR (If Sensor Disabled) | Distance Setting (00.0-10.0) Between Cutterbar & Ground. |
| ##.# HEADER ANGLE ##.# TILT SENSOR (If Sensor Disabled) | Angle Setting (00.0-10.0) Header Relative To Ground. |
| ##.# L FLOAT R ##.# | Left and Right Float Setting (0.0-10.0). |
| LOAD ■■■■■____ #### (If Metric) ##### | Bar Graph Representing Hydraulic Operating Pressure. Full Scale Is Pre-Programmed Overload Pressure (2500-5000 psi). If Sensor Disabled, LOAD Does Not Display. |
| ### °C or F HYD OIL | Hydraulic Oil Temperature. |
| ##.# VOLTS | Engine Electrical System Operating Voltage. |
| SCROLL <i>SUB-MENU (Lower Line Only)</i> #### DISC RPM ##.# HEADER HEIGHT LOAD ■■■■■■■■■■■ #### | Displays Sub-Menu After 2-3 Seconds. Press SELECT to cancel. Scroll Through Sub-Menu Display with CDM Switch |

OPERATOR'S STATION

MISCELLANEOUS OPERATIONAL INFORMATION

| DISPLAY (Upper Line) | DESCRIPTION |
|----------------------|--|
| < LEFT TURN ■ | Indicates Left Turn When  Is Pressed On CDM. See Note 1. |
| ■ RIGHT TURN > | Indicates Left Turn When  Is Pressed On CDM. See Note 2. |
| ■ HAZARD ■ | Indicates Hazard Warning Lights Are On When  Is Pressed On CDM. |
| HEADER REVERSE | Header Drive Running In Reverse. |
| HEADER ENGAGED | Header Drive Engaged. |
| ROAD GEAR | With Hi Range Selected On Console Switch. Engine-forward Only. See Note. |

NOTE: 1. If road light kit is not installed, CDM will display LEFT STOP LAMP as a malfunction in CAB-FORWARD mode.
2. If road light kit is not installed, CDM will display RIGHT STOP LAMP as a malfunction in CAB-FORWARD mode.

OPERATOR'S STATION

5.18.4 CAB DISPLAY MODULE (CDM) WARNINGS/ALARMS

The CDM displays warnings and sounds alarms to notify the operator of abnormal windrower status at startup when the ignition is turned on and at engine operating speeds above 500 rpm.

5.18.4.1 Engine Warning Lights

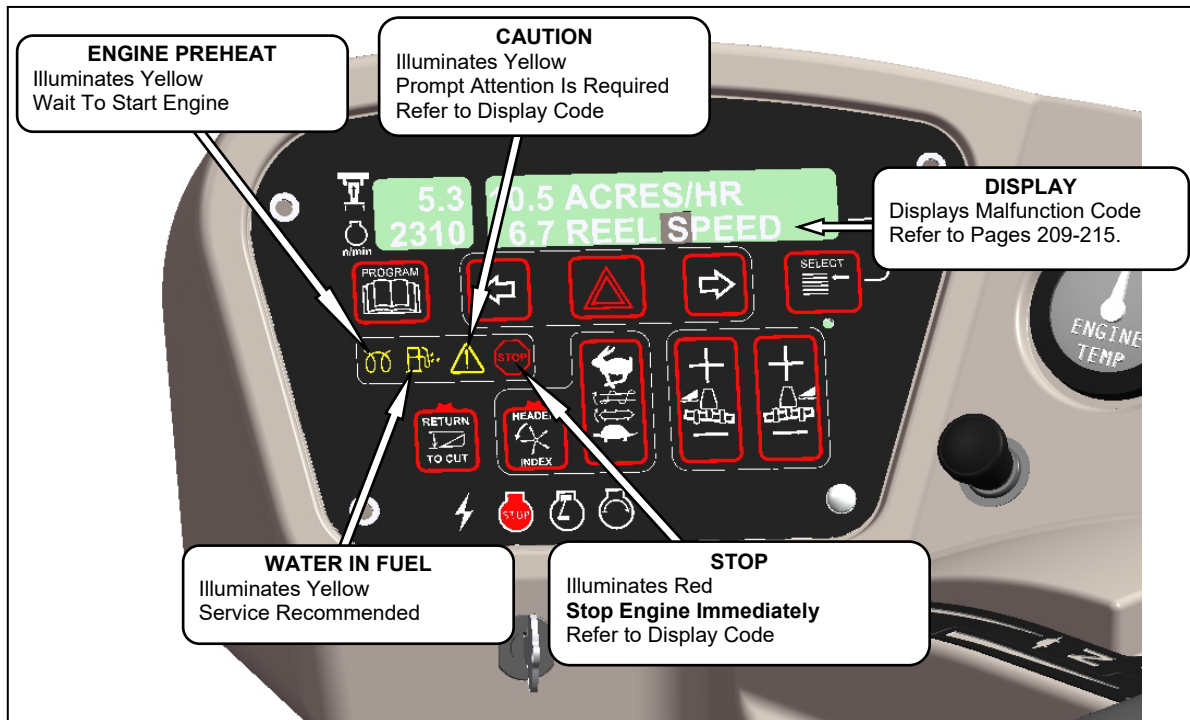

OPERATOR'S STATION

5.18.4.2 Display Warnings

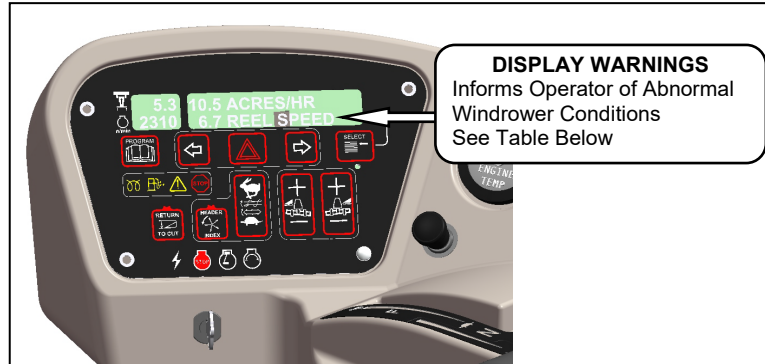

DISPLAY WARNINGS AND ALARMS

| DISPLAY | FLASHING | ALARM TONE | DESCRIPTION |
|---|----------|---|--|
| BRAKE OFF | | | Engine Running, Brake Solenoid Not Activated. |
| BRAKE ON | ✓ | Short Beep With Each Flash. | GSL Out Of N-Detent But Interlock Switch Remains Closed To Apply Brake. |
| BRAKE SW FAILURE | | | Ignition On/Engine Not Running, Brake Switch and Relay Closed. |
| CAB-FORWARD SW ON/ ENG FORWARD SW ON | ✓ | Messages Flash Alternately. | Both Seat Switches Activated. |
| CENTER STEERING | | Beeps At 2 Per Second. | GSL or Interlock Switches Not Closed With Key On/Engine Off. |
| DISENGAGE HEADER RE-ENGAGE <1800RPM> | ✓ | None | R80/R85 – Engine RPM Above 1800. |
| ENGINE AIR FILTER | ✓ | Single Loud Tone For 10 Seconds. Repeats Every 30 Minutes Until Condition Is Corrected. | Engine Air Filter Requires Servicing. |
| ENGINE OIL PRESSURE | ✓ | Continuous Loud Tone Until Oil Pressure Is Regained. | Low Engine Oil Pressure. |
| ENGINE TEMPERATURE | ✓ | Ongoing Intermittent Moderate Tone Until Temperature Is Below 215F. (102C.) | Engine Temperature Over 230F. (110C.) |
| HEADER DISENGAGED | | None | Normal |
| DISENGAGE HEADER | ✓ | None | Header Switch Is In On Position When Ignition Switch Turned On. |
| HEADER OIL PRESS | ✓ | Continuous Loud Tone Until Oil Pressure Is Regained. | Low Header Charge Oil Pressure. Header Shuts Down Automatically. Header On Switch Must Be Moved To Off Position and Then To On Position To Restart The Header. |
| HYDRAULIC FILTER | ✓ | Single Loud Tone For 10 Seconds. Repeats Every 15 Minutes Until Condition Is Corrected. | Excessive Pressure Increase Across Hydraulic Oil Filter. |

OPERATOR'S STATION
DISPLAY WARNINGS AND ALARMS (Continued)

| DISPLAY | FLASHING | ALARM TONE | DESCRIPTION |
|-----------------------------|----------|--|--|
| ### °C or F HYD OIL COLD | ✓ | Tone Sounds With Each Flash For 5 Seconds and Then Stops For 1 Minute. Flashing Continues. If Oil Still Cold After 1 Minute, Tone Sounds Again. | Hydraulic Oil Temp <10C or 50F. |
| ### °C or F HYD OIL HOT | ✓ | Tone With Each Flash At 105C (220F) For 5 Seconds and Then Stops For 1 Minute. Flashing Continues. If Oil Still Hot After 1 Minute, Tone Sounds Again. Flashing & Steady Tone At 110C (230F) and Higher. | Hydraulic Oil Temp >105C (220F) but <110C (230F). |
| IN PARK | ✓ | One Short Beep. | GSL In N-Detent, Steering Wheel Centered, and Brakes Are Engaged. |
| KNIFE SPEED OVERLOAD | ✓ | Short Beep With Each Flash Until Condition Is Corrected. | Machine Overload. Knife or Disc Speed Drops Below Programmed Value. |
| LOCK SEAT BASE | | | Seat Base Not Detected In Cab or Engine-forward Position. |
| LOW HYDRAULIC OIL | ✓ | Continuous Loud Tone For 5 Seconds. If Condition Not Rectified, Single Loud Tone Every 5 Minutes. | Low Hydraulic Oil Level. Header Shuts Down Automatically If Engaged. Header On Switch Must Be Moved To OFF Position and Then To ON Position To Restart The Header. |
| NO HEADER | | None | Header Is Not Detected. |
| NO OPERATOR | | Continuous Tone. | Operator Not Detected In Seat With Header Engaged or Out Of Neutral Detent. Engine Shutdown After 5 Seconds. |
| NO OPERATOR ENGINE SHUTDOWN | | Continuous Tone. | Engine Shutdown When Operator Not Detected In Seat With Machine Moving Under 3 mph (4.8 km/h). |
| NOT IN PARK | ✓ | Short Beep With Each Flash. | GSL or Interlock Switches Not Closed With Key On/Engine Off. |
| PLACE GSL INTO "N" | | Beeps At 2 Per Second Until Corrected. | GSL or Interlock Switches Not Closed With Key On/Engine Off. |
| SLOW DOWN | ✓ | Short Beep With Each Flash. | Ground Speed is Greater Than or Equal to 25 mph (40 km/h). Operator Should Pull Back on the GSL to Reduce Ground Speed. |
| TRANS OIL PRESS | ✓ | Continuous Loud Tone Until Oil Pressure Is Regained. | Low Transmission Charge Oil Pressure. |
| TRANS OIL TEMP | ✓ | Ongoing Intermittent Moderate Tone Until Temperature Is Below Acceptable Level. | Transmission Oil Temperature Above 221F (106C). |
| ##.# LOW VOLTS | ✓ | Single Loud Tone For 10 Seconds. | Voltage Below 11.5. |
| ##.# HIGH VOLTS | ✓ | Single Loud Tone For 10 Seconds. | Voltage Above 16. |

OPERATOR'S STATION

5.18.5 CAB DISPLAY MODULE (CDM) PROGRAMMING

The monitoring system requires programming for each header and the **header must be attached to the windrower** so that the CDM recognizes the type of header. Programming the system may be accomplished with or without the engine running. If the engine is running, the transmission must be in neutral. If the engine is not running, the ignition must be on. Exit programming mode at any time by pressing the PROGRAM switch or by turning off the ignition.

The system only needs to be programmed once for each header. The operator may make changes later on to a particular setting to suit windrowing conditions or modifications to the machine. Refer to paragraph 5.18.6 Setting Guidelines for recommended settings. Most functions have been pre-programmed at the factory but can be changed by the operator if required.







NOTE

Contact your dealer for information regarding software updates to the electronic modules. Your dealer will have the necessary interface tools and access to the latest software upgrades.

Proceed as follows to program the CDM:

IMPORTANT

Header must be attached to the windrower so that the CDM can detect the type of header (Header ID) and adjust the programming mode accordingly.

- Turn ignition key to RUN, or start the engine. Refer to paragraph 6.3.5 Engine Operation.
- Press PROGRAM and SELECT on CDM to enter programming mode. Header ID code is displayed.
- Press SELECT. TRACTOR SETUP? is displayed on upper line.
- Press  SET KNIFE SPEED? is displayed
- Press  or  to change value on lower line.
- Press SELECT. KNIFE OVERLOAD SPD? is displayed.
- Press  or  to change value on lower line.
- Press SELECT. KNIFE OVERLOAD SPD? is displayed.
- Press  or  to change value on lower line.
- Press SELECT to advance to the next L1 item and press arrow keys to change values. Refer to Detailed Programming Instructions on following pages.
- Press PROGRAM to exit programming mode when finished entering desired values.

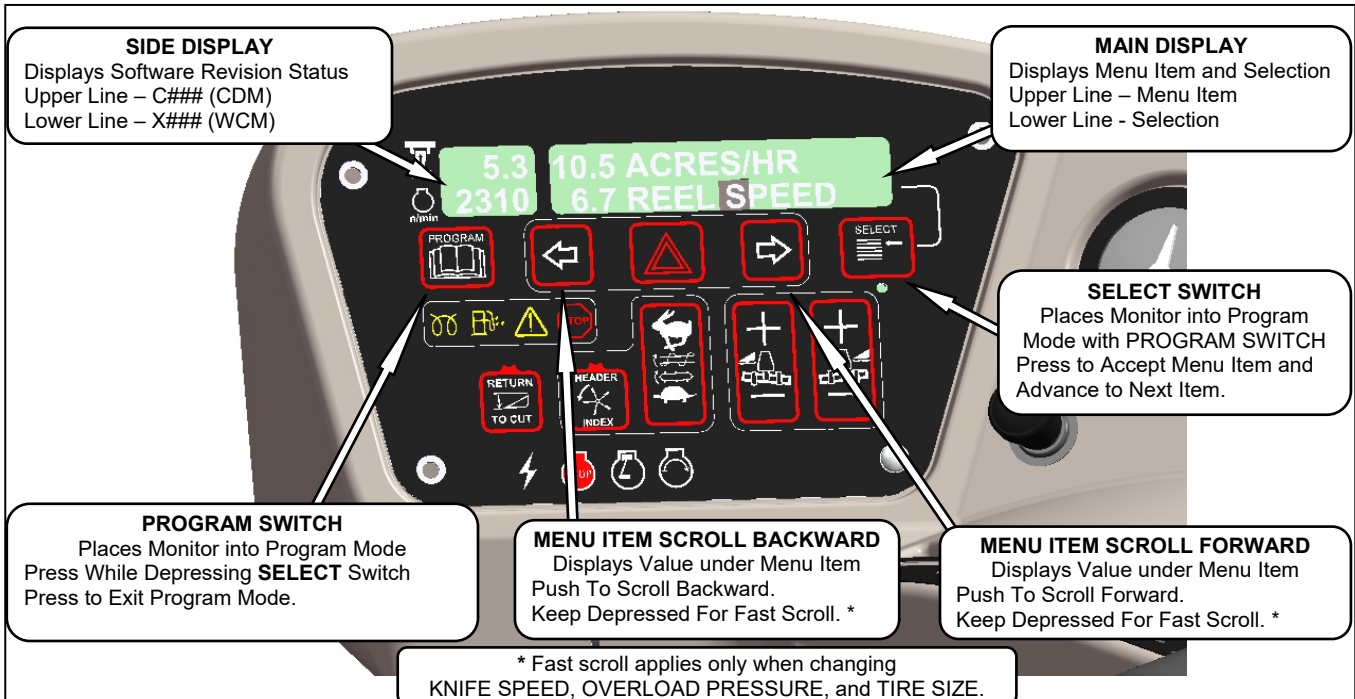

OPERATOR'S STATION

DETAILED PROGRAMMING INSTRUCTIONS

IMPORTANT: ENGINE MUST BE RUNNING TO CALIBRATE SENSORS.

NOTE: The software version code Mxxx in the following charts will show as Xxxx on the CDM for the M205 windrower.

Programming Menu Flow Chart

| | | |
|----------------------------|--|---|
| L1 | C x x x x TRACTOR SETUP? | if "NO" then jump to: |
| L2 | M x x x x NO / YES | C A B D I S P L A Y S E T U P ? |
| L1 L2 or L1 L2 | C x x x x SET KNIFE SPEED? M x x x x 1 2 0 0 S P M | <p>When the programming mode is entered the header ID will be displayed on the top line of the CDM using the last 4 display positions.</p> |
| L1 | C x x x x KNIFE OVERLOAD SPD? | |
| L2 | M x x x x 1 0 0 0 S P M | |
| L2 | C x x x x DISK OVERLOAD SPD? | |
| L2 | M x x x x 2 0 0 0 R P M | <p>Pressing "SELECT" will go to the next line 1 (L1) menu selection. The turn signal "arrow" keys are used to change the values. Pressing "PROGRAM" at any time will cancel the programming mode / menus and return back to the main operating displays.</p> |
| L1 | C x x x x OVERLOAD PRESSURE? | |
| L2 | M x x x x 4 0 0 0 P S I | |
| L1 | C x x x x HEADER INDEX MODE? | |
| L2 | M x x x x REEL & CONVEYOR | <p>The auto raise setting can be changed from 4.0 (min.) to 10.0 (max.) in 0.5 increments. OFF disables the auto raise function.</p> |
| L2 | M x x x x REEL ONLY | |
| L1 | C x x x x RETURN TO CUT MODE? | |
| L2 | M x x x x HEIGHT & TILT | |
| L2 | M x x x x HEIGHT ONLY | <p>The auto raise setting can be changed from 4.0 (min.) to 10.0 (max.) in 0.5 increments. OFF disables the auto raise function.</p> |
| L1 | C x x x x AUTO RAISE HEIGHT? | |
| L2 | M x x x x 4 . 0 | |
| L2 | M x x x x OFF | |
| L1 | C x x x x DWA INSTALLED? | if "NO" then jump to: |
| L2 | M x x x x NO / YES | H E A D E R C U T W I D T H ? |
| L1 L2 | C x x x x SWAP DWA CONTROLS? M x x x x NO / YES | <p>Swaps the GSL reel fore / aft with the DWA console controls. If NO jump to DWA AUTO UP & DOWN?</p> |
| L1 | C x x x x DWA AUTO UP / DOWN? | |
| L2 | M x x x x NO / YES | <p>Enables the express up and down feature with the header RTC. If NO jump to HEADER CUT WIDTH?</p> |
| L2 | M x x x x NO / YES | |
| L1 | C x x x x TILT CYL INSTALLED? | Appears for M150 ONLY - If "NO" then jump to: |
| L2 | M x x x x NO / YES | H E A D E R C U T W I D T H ? |
| L1 | C x x x x DISC BLK INSTALLED? | if "NO" then jump to: |
| L2 | M x x x x NO / YES | H E A D E R C U T W I D T H ? |
| L1 | C x x x x HDR CUT WIDTH? 0 1 0 1 | <p>Use the "arrow" keys to set the header cut width. The header ID appears at the RHS.</p> |
| L2 | M x x x x 2 0 . 5 F E E T | |
| L1 | C x x x x HAY CONDITIONER? | <p>DRAPER HEADER ONLY. Default will be flashing. Use "arrow" keys to select.</p> |
| L2 | M x x x x NO / YES | |
| L1 | C x x x x AUGER HDR REEL SPD | A U G E R H E A D E R O N L Y |
| L2 | M x x x x R P M / M P H | For IMPERIAL display. |
| L2 | M x x x x R P M / K P H | For METRIC display. |
| L1 | C x x x x SET TIRE SIZE? | <p>Pressing "SELECT" will go to the next line 1 (L1) menu selection. The turn signal "arrow" keys are used to change the values.</p> |
| L2 | M x x x x 1 8 . 4 X 2 6 T U R F | |
| L2 | M x x x x 1 8 . 4 X 2 6 B A R | |
| L2 | M x x x x 2 3 . 1 X 2 6 T U R F | |
| L2 | M x x x x 6 0 0 - 6 5 R 2 8 | |
| L2 | M x x x x 5 8 0 / 7 0 R 2 6 T U R F | |
| L1 | C x x x x SET ENGINE ISC RPM? | if "NO" then jump to: |
| L2 | M x x x x NO / YES | S E T C O N T R O L L O C K S ? |
| L1 L2 | C x x x x PRESS HAZARD TO SET M x x x x ISC RPM OFF | <p>This is used to set the Intermediate Speed Control function for the engine. The default or last selected rpm will be displayed first and will be flashing.</p> <p>The "arrow" keys are used to cycle between the selections. When "SELECT" is pressed the program goes to the EXIT ENGINE ISC? menu selection.</p> |
| L1 | C x x x x PRESS HAZARD TO SET | |
| L2 | M x x x x ISC RPM 2 0 0 0 | |
| L1 | C x x x x PRESS HAZARD TO SET | |
| L2 | M x x x x ISC RPM 1 9 0 0 | |
| L1 | C x x x x PRESS HAZARD TO SET | <p>This is used to set the Intermediate Speed Control function for the engine. The default or last selected rpm will be displayed first and will be flashing.</p> <p>The "arrow" keys are used to cycle between the selections. When "SELECT" is pressed the program goes to the EXIT ENGINE ISC? menu selection.</p> |
| L2 | M x x x x ISC RPM 1 8 0 0 | |

(continued next page)

OPERATOR'S STATION

| | | |
|---|----------------------------------|--|
| | L1 C x x x EXIT ENGINE ISC? | If "NO" then jump to: |
| | L2 M x x x ← NO / YES → | PRESS HAZARD TO SET |
| L1 | C x x x SET CONTROL LOCKS? | If "NO" then jump to: |
| L2 | M x x x ← NO / YES → | VIEW CONTROL LOCKS? |
| <div style="border: 1px solid black; padding: 5px; margin-bottom: 5px;"> ↙ L1 C x x x HEADER TILT L2 M x x x ← ENABLED / LOCKED → </div> <div style="border: 1px solid black; padding: 5px; margin-bottom: 5px;"> L1 C x x x HEADER FLOAT L2 M x x x ← ENABLED / LOCKED → </div> <div style="border: 1px solid black; padding: 5px; margin-bottom: 5px;"> L1 C x x x REEL FORE / AFT L2 M x x x ← ENABLED / LOCKED → </div> <div style="border: 1px solid black; padding: 5px; margin-bottom: 5px;"> L1 C x x x DRAPER SPEED L2 M x x x ← ENABLED / LOCKED → </div> <div style="border: 1px solid black; padding: 5px; margin-bottom: 5px;"> L1 C x x x AUGER SPEED L2 M x x x ← ENABLED / LOCKED → </div> <div style="border: 1px solid black; padding: 5px; margin-bottom: 5px;"> L1 C x x x KNIFE SPEED L2 M x x x ← ENABLED / LOCKED → </div> <div style="border: 1px solid black; padding: 5px; margin-bottom: 5px;"> L1 C x x x DISK SPEED L2 M x x x ← ENABLED / LOCKED → </div> <div style="border: 1px solid black; padding: 5px; margin-bottom: 5px;"> L1 C x x x REEL SPEED L2 M x x x ← ENABLED / LOCKED → </div> <div style="border: 1px solid black; padding: 5px; margin-bottom: 5px;"> L1 C x x x EXIT CONTROL LOCKS? L2 M x x x ← NO / YES → </div> | | <div style="border: 1px solid black; padding: 10px;"> <p>This menu allows the operator to selectably "lock out" the control functions for the various header functions. The default or selected "status" for each item will flash.</p> <p>The "arrow" keys are used to ENABLE or LOCK OUT each function. Pressing "SELECT" will go to the next L1 menu item.</p> </div> <div style="border: 1px solid black; padding: 5px; margin-top: 10px;"> If "NO" then jump to: HEADER TILT </div> |
| L1 | C x x x VIEW CONTROL LOCKS? | If "NO" then jump to: |
| L2 | M x x x ← NO / YES → | EXIT TRACTOR SETUP? |
| <div style="border: 1px solid black; padding: 5px; margin-bottom: 5px;"> ↙ L1 C x x x HEADER TILT ← → L2 M x x x 5 7 5 . 1 HRS ENABLED L2 M x x x 6 4 8 . 6 HRS LOCKED </div> <div style="border: 1px solid black; padding: 5px; margin-bottom: 5px;"> L1 C x x x HEADER FLOAT ← → L2 M x x x 5 7 5 . 1 HRS ENABLED L2 M x x x 6 4 8 . 6 HRS LOCKED </div> <div style="border: 1px solid black; padding: 5px; margin-bottom: 5px;"> L1 C x x x REEL FORE / AFT ← → L2 M x x x 5 7 5 . 1 HRS ENABLED L2 M x x x 6 4 8 . 6 HRS LOCKED </div> <div style="border: 1px solid black; padding: 5px; margin-bottom: 5px;"> L1 C x x x DRAPER SPEED ← → L2 M x x x 5 7 5 . 1 HRS ENABLED L2 M x x x 6 4 8 . 6 HRS LOCKED </div> <div style="border: 1px solid black; padding: 5px; margin-bottom: 5px;"> L1 C x x x AUGER SPEED ← → L2 M x x x 5 7 5 . 1 HRS ENABLED L2 M x x x 6 4 8 . 6 HRS LOCKED </div> <div style="border: 1px solid black; padding: 5px; margin-bottom: 5px;"> L1 C x x x KNIFE SPEED ← → L2 M x x x 5 7 5 . 1 HRS ENABLED L2 M x x x 6 4 8 . 6 HRS LOCKED </div> <div style="border: 1px solid black; padding: 5px; margin-bottom: 5px;"> L1 C x x x DISK SPEED ← → L2 M x x x 5 7 5 . 1 HRS ENABLED L2 M x x x 6 4 8 . 6 HRS LOCKED </div> <div style="border: 1px solid black; padding: 5px; margin-bottom: 5px;"> L1 C x x x REEL SPEED ← → L2 M x x x 5 7 5 . 1 HRS ENABLED L2 M x x x 6 4 8 . 6 HRS LOCKED </div> <div style="border: 1px solid black; padding: 5px; margin-bottom: 5px;"> L1 C x x x EXIT VIEW LOCKOUTS? L2 M x x x ← NO / YES → </div> | | <div style="border: 1px solid black; padding: 10px;"> <p>When the control lock outs are viewed the lower display line (L2) will show the engine hours and either ENABLED or LOCKED to indicate the present status along with the engine hours at which time the function was either ENABLED or LOCKED.</p> <p>Using the "arrow" keys allows the operator to select the various functions. Pressing "SELECT" will go to the EXIT VIEW LOCKOUTS? menu selection.</p> </div> <div style="border: 1px solid black; padding: 5px; margin-top: 10px;"> If "NO" then jump to: HEADER TILT ← → </div> |
| L1 | C x x x EXIT TRACTOR SETUP? | If "NO" then jump to: |
| L2 | M x x x ← NO / YES → | SET KNIFE SPEED? |

OPERATOR'S STATION

(continued next page)

OPERATOR'S STATION

| | | | |
|----|---------|---------------------------------|-----------------------------------|
| L1 | C x x x | C A B D I S P L A Y S E T U P ? | If "NO" then jump to: |
| L2 | M x x x | ← NO / YES → | C A L I B R A T E S E N S O R S ? |

| | | | |
|----|---------|---------------------------------|--|
| L1 | C x x x | D I S P L A Y L A N G U A G E ? | Use the "arrow" keys to change the default language. Pressing "SELECT" goes to the next L1 menu selection. |
| L2 | M x x x | ← ENGLISH → | |
| L2 | M x x x | ← ESPANOL → | |

| | | | |
|----|---------|---------------------------|--|
| L1 | C x x x | D I S P L A Y U N I T S ? | The "arrow" keys are used to select between IMPERIAL or METRIC. The default value will be displayed first. |
| L2 | M x x x | ← IMPERIAL → | |
| L2 | M x x x | ← METRIC → | |

| | | | |
|----|---------|-------------------------------|---|
| L1 | C x x x | C D M B U Z Z E R V O L U M E | The "arrow" keys are used to change the CDM buzzer volume, CDM backlighting or the CDM contrast, with the bar graph indicating the relative level for each item. When "SELECT" is pressed the program goes to the EXIT DISPLAY SETUP? menu selection. |
| L2 | M x x x | ← [Bar Graph] → | |

| | | | |
|----|---------|-------------------------------|--|
| L1 | C x x x | C D M B A C K L I G H T I N G | |
| L2 | M x x x | ← [Bar Graph] → | |

| | | | |
|----|---------|-----------------------|--|
| L1 | C x x x | C D M C O N T R A S T | |
| L2 | M x x x | ← [Bar Graph] → | |

| | | | |
|----|---------|-----------------------------------|---------------------------------|
| L1 | C x x x | E X I T D I S P L A Y S E T U P ? | If "NO" then jump to: |
| L2 | M x x x | ← NO / YES → | D I S P L A Y L A N G U A G E ? |

| | | | |
|----|---------|-----------------------------------|-------------------------------|
| L1 | C x x x | C A L I B R A T E S E N S O R S ? | If "NO" then jump to: |
| L2 | M x x x | ← NO / YES → | D I A G N O S T I C M O D E ? |

| | | | |
|----|---------|-----------------------------------|--|
| L1 | C x x x | T O C A L I B R A T E S E L E C T | The operator can select any of the three items requiring calibration (or exit the CAL menu) by using the turn signal switches to cycle through the choices. Pressing SELECT will take the operator to the calibration menu for that particular sensor. |
| L2 | M x x x | ← HEADER HEIGHT → | |
| L2 | M x x x | ← HEADER TILT → | |
| L2 | M x x x | ← HEADER FLOAT → | |
| L2 | M x x x | ← EXIT CAL? ← NO / YES → | |

| | | | |
|----|---------|-------------------------------|---|
| L1 | C x x x | H E I G H T S E N S O R C A L | The display will indicate the sensor being calibrated. The operator will be prompted to raise the header and HOLD will flash until the system has completed reading in the signal with the header fully raised. HOLD will change to DONE (with buzzer). |
| L2 | M x x x | ← RAISE HDR TO START → | |

| | | | |
|----|---------|-----------------------------------|--|
| L1 | C x x x | C A L I B R A T I N G H E I G H T | |
| L2 | M x x x | ← RAISE HEADER HOLD → | |
| L2 | M x x x | ← HEADER RAISE DONE → | |

| | | | |
|----|---------|-----------------------------------|--|
| L1 | C x x x | C A L I B R A T I N G H E I G H T | When the header raise is done, the CDM will prompt the user to lower the header. COMPLETE (with buzzer) will flash on the screen for 2 seconds when the calibration is finished. |
| L2 | M x x x | ← LOWER HEADER HOLD → | |
| L2 | M x x x | ← HT SENSOR COMPLETE → | |

| | | | |
|----|---------|-----------------------------------|--|
| L1 | C x x x | T O C A L I B R A T E S E L E C T | The operator can select any of the three items requiring calibration (or exit the CAL menu) by using the turn signal switches to cycle through the choices. Pressing SELECT will take the operator to the calibration menu for that particular sensor. |
| L2 | M x x x | ← HEADER HEIGHT → | |
| L2 | M x x x | ← HEADER TILT → | |
| L2 | M x x x | ← HEADER FLOAT → | |
| L2 | M x x x | ← EXIT CAL? ← NO / YES → | |

| | | | |
|----|---------|---------------------------------|--|
| L1 | C x x x | H D R T I L T S E N S O R C A L | The display will indicate the sensor being calibrated. The operator will be prompted to extend the header tilt and HOLD will flash until the system has completed reading in the signal with the header tilt fully extended. HOLD will change to DONE (with buzzer). |
| L2 | M x x x | ← EXTEND TILT TO START → | |

| | | | |
|----|---------|-------------------------------|--|
| L1 | C x x x | C A L I B R A T I N G T I L T | |
| L2 | M x x x | ← EXTEND TILT HOLD → | |
| L2 | M x x x | ← EXTEND TILT DONE → | |

| | | | |
|----|---------|-------------------------------|---|
| L1 | C x x x | C A L I B R A T I N G T I L T | When the header tilt extend is done, the CDM will prompt the user to press the header tilt retract. COMPLETE (with buzzer) will flash on the screen for 2 seconds when the calibration is finished. |
| L2 | M x x x | ← RETRACT TILT HOLD → | |
| L2 | M x x x | ← HDR TILT COMPLETE → | |

| | | | |
|----|---------|-----------------------------------|--|
| L1 | C x x x | T O C A L I B R A T E S E L E C T | The operator can select any of the three items requiring calibration (or exit the CAL menu) by using the turn signal switches to cycle through the choices. Pressing SELECT will take the operator to the calibration menu for that particular sensor. |
| L2 | M x x x | ← HEADER HEIGHT → | |
| L2 | M x x x | ← HEADER TILT → | |
| L2 | M x x x | ← HEADER FLOAT → | |
| L2 | M x x x | ← EXIT CAL? ← NO / YES → | |

| | | | |
|----|---------|---------------------------------|--|
| L1 | C x x x | C A L I B R A T I N G F L O A T | The display will indicate the sensor being calibrated. The operator will be prompted to press the float (+) and HOLD will flash until the system has completed reading in the signal with the header float fully extended. HOLD will change to DONE (with buzzer). |
| L2 | M x x x | ← PRESS FLT+ TO START → | |

| | | | |
|----|---------|---------------------------------|--|
| L1 | C x x x | C A L I B R A T I N G F L O A T | |
| L2 | M x x x | ← FLOAT (+) HOLD → | |
| L2 | M x x x | ← FLOAT (+) DONE → | |

| | | | |
|----|---------|---------------------------------|--|
| L1 | C x x x | C A L I B R A T I N G F L O A T | When the header float (+) is done, the CDM will prompt the user to press the header float (-). COMPLETE (with buzzer) will flash on the screen for 2 seconds when the calibration is finished. |
| L2 | M x x x | ← FLOAT (-) HOLD → | |
| L2 | M x x x | ← HDR FLOAT COMPLETE → | |

(continued next page)

OPERATOR'S STATION

| | | |
|----------------------------------|---|--|
| L2 | C x x x TO CALIBRATE SELECT | Select any of the sensors by using the turn signal switches to cycle through the choices. Pressing SELECT will take the operator to the calibration menu for that particular sensor. NO is the default for EXIT CAL?. If "NO" then jump to: TO CALIBRATE SELECT |
| L2 | M x x x <input type="button" value="←"/> HEADER HEIGHT <input type="button" value="→"/> | |
| L2 | M x x x <input type="button" value="←"/> HEADER TILT <input type="button" value="→"/> | |
| L1 | M x x x <input type="button" value="←"/> HEADER FLOAT <input type="button" value="→"/> | |
| L2 | M x x x EXIT CAL? <input type="button" value="←"/> NO / YES <input type="button" value="→"/> | |
| L1 | C x x x DIAGNOSTIC MODE? <input type="button" value="←"/> <input type="button" value="→"/> | if "NO" then jump to: <input style="width: 100px;" type="text"/> |
| L2 | M x x x <input type="button" value="←"/> NO / YES <input type="button" value="→"/> | TRACTOR SETUP? <input type="button" value="←"/> <input type="button" value="→"/> |
| <input type="button" value="↙"/> | | |
| L1 | C x x x VIEW ERROR CODES? <input type="button" value="←"/> <input type="button" value="→"/> | if "NO" then jump to: <input style="width: 100px;" type="text"/> |
| L2 | M x x x <input type="button" value="←"/> NO / YES <input type="button" value="→"/> | ENTER SENSOR SETUP? <input type="button" value="←"/> <input type="button" value="→"/> |
| <input type="button" value="↙"/> | | |
| L1 | C x x x VIEW TRACTOR CODES? <input type="button" value="←"/> <input type="button" value="→"/> | if "NO" then jump to: <input style="width: 100px;" type="text"/> |
| L2 | M x x x <input type="button" value="←"/> NO / YES <input type="button" value="→"/> | VIEW ENGINE CODES? <input type="button" value="←"/> <input type="button" value="→"/> |
| L1 | <input type="text" value="1"/> <input type="text" value="1"/> <input type="text" value="2"/> <input type="text" value="3"/> <input type="text" value="4"/> <input type="text" value="5"/> HRS 1 2 3 <input type="button" value="←"/> <input type="button" value="→"/> | The last 10 distinct error codes are stored along with the code #, Exxx, engine hours and number of occurrences. The "arrow" keys are used to cycle between codes. |
| L2 | E 4 7 SENSOR VOLTS LOW <input type="button" value="←"/> <input type="button" value="→"/> | |
| L1 | <input type="text" value="2"/> <input type="text" value="1"/> <input type="text" value="2"/> <input type="text" value="3"/> <input type="text" value="0"/> <input type="text" value="5"/> HRS 1 2 3 <input type="button" value="←"/> <input type="button" value="→"/> | If "NO" then jump to the first error code logged. |
| L2 | E 7 1 LOW HYDRAULIC OIL <input type="button" value="←"/> <input type="button" value="→"/> | |
| L1 | C x x x EXIT TRACTOR CODES? <input type="button" value="←"/> <input type="button" value="→"/> | if "NO" then jump to: <input style="width: 100px;" type="text"/> |
| L2 | M x x x <input type="button" value="←"/> NO / YES <input type="button" value="→"/> | ENTER SENSOR SETUP? <input type="button" value="←"/> <input type="button" value="→"/> |
| L1 | C x x x VIEW ENGINE CODES? <input type="button" value="←"/> <input type="button" value="→"/> | if "NO" then jump to: <input style="width: 100px;" type="text"/> |
| L2 | M x x x <input type="button" value="←"/> NO / YES <input type="button" value="→"/> | ENTER SENSOR SETUP? <input type="button" value="←"/> <input type="button" value="→"/> |
| L1 | <input type="text" value="1"/> <input type="text" value="1"/> <input type="text" value="2"/> <input type="text" value="3"/> <input type="text" value="4"/> <input type="text" value="5"/> HRS 1 2 3 <input type="button" value="←"/> <input type="button" value="→"/> | The last 10 distinct error codes are stored. |
| L2 | 4 4 9 FUEL PRESSURE HIGH <input type="button" value="←"/> <input type="button" value="→"/> | |
| L1 | C x x x EXIT ENGINE CODES? <input type="button" value="←"/> <input type="button" value="→"/> | if "NO" then jump to the first engine error code logged. |
| L2 | M x x x <input type="button" value="←"/> NO / YES <input type="button" value="→"/> | VIEW TRACTOR CODES? <input type="button" value="←"/> <input type="button" value="→"/> |
| L1 | C x x x EXIT ERROR CODES? <input type="button" value="←"/> <input type="button" value="→"/> | if "NO" then jump to: <input style="width: 100px;" type="text"/> |
| L2 | M x x x <input type="button" value="←"/> NO / YES <input type="button" value="→"/> | VIEW TRACTOR CODES? <input type="button" value="←"/> <input type="button" value="→"/> |
| L1 | C x x x ENTER SENSOR SETUP? <input type="button" value="←"/> <input type="button" value="→"/> | if "NO" then jump to: <input style="width: 100px;" type="text"/> |
| L2 | M x x x <input type="button" value="←"/> NO / YES <input type="button" value="→"/> | READ SENSOR INPUTS? <input type="button" value="←"/> <input type="button" value="→"/> |
| <input type="button" value="↙"/> | | |
| L1 | C x x x KNIFE SPEED SENSOR <input type="button" value="←"/> <input type="button" value="→"/> | The operator can select each sensor and selectively enable or disable the sensor. This can be used to disable a failed sensor to eliminate false or erratic display readings. When "SELECT" is pressed the program goes to the EXIT SENSOR SETUP? menu selection. NOTE: The oil temp. readout applies to the M205 model with the Sensata oil temp. sensor. |
| L2 | M x x x <input type="button" value="←"/> ENABLE / DISABLE <input type="button" value="→"/> | |
| L1 | C x x x REEL SPEED SENSOR <input type="button" value="←"/> <input type="button" value="→"/> | |
| L2 | M x x x <input type="button" value="←"/> ENABLE / DISABLE <input type="button" value="→"/> | |
| L1 | C x x x HEADER HT SENSOR <input type="button" value="←"/> <input type="button" value="→"/> | |
| L2 | M x x x <input type="button" value="←"/> ENABLE / DISABLE <input type="button" value="→"/> | |
| L1 | C x x x HEADER TILT SENSOR <input type="button" value="←"/> <input type="button" value="→"/> | |
| L2 | M x x x <input type="button" value="←"/> ENABLE / DISABLE <input type="button" value="→"/> | |
| L1 | C x x x HEADER FLOAT SENSOR <input type="button" value="←"/> <input type="button" value="→"/> | |
| L2 | M x x x <input type="button" value="←"/> ENABLE / DISABLE <input type="button" value="→"/> | |
| L1 | C x x x OVERLOAD PRESSURE <input type="button" value="←"/> <input type="button" value="→"/> | |
| L2 | M x x x <input type="button" value="←"/> ENABLE / DISABLE <input type="button" value="→"/> | |
| L1 | C x x x HYD OIL TEMP SENSOR <input type="button" value="←"/> <input type="button" value="→"/> | |
| L2 | M x x x <input type="button" value="←"/> ENABLE / DISABLE <input type="button" value="→"/> | |
| L1 | C x x x EXIT SENSOR SETUP? <input type="button" value="←"/> <input type="button" value="→"/> | if "NO" then jump to: <input style="width: 100px;" type="text"/> |
| L2 | M x x x <input type="button" value="←"/> NO / YES <input type="button" value="→"/> | KNIFE SPEED SENSOR <input type="button" value="←"/> <input type="button" value="→"/> |
| L1 | C x x x READ SENSOR INPUTS? <input type="button" value="←"/> <input type="button" value="→"/> | if "NO" then jump to: <input style="width: 100px;" type="text"/> |
| L2 | M x x x <input type="button" value="←"/> NO / YES <input type="button" value="→"/> | ACTIVATE FUNCTIONS? <input type="button" value="←"/> <input type="button" value="→"/> |
| <input type="button" value="↙"/> | | |
| L1 | C x x x SENSOR INPUT <input type="button" value="←"/> <input type="button" value="→"/> | For diagnostic purposes each sensors input signal can be read. This helps in determining how each sensor is operating and if the proper output voltages are being received by the control system. |
| L2 | M x x x HDR HEIGHT <input type="text" value="3"/> . <input type="text" value="5"/> 9 V <input type="button" value="←"/> <input type="button" value="→"/> | |
| L1 | C x x x SENSOR INPUT <input type="button" value="←"/> <input type="button" value="→"/> | |
| L2 | M x x x HDR ANGLE <input type="text" value="1"/> . <input type="text" value="8"/> 4 V <input type="button" value="←"/> <input type="button" value="→"/> | |
| L1 | C x x x SENSOR INPUT <input type="button" value="←"/> <input type="button" value="→"/> | |
| L2 | M x x x 2 . 4 5 V FLOAT 2 . 8 4 V <input type="button" value="←"/> <input type="button" value="→"/> | |
| L1 | C x x x SENSOR INPUT <input type="button" value="←"/> <input type="button" value="→"/> | |
| L2 | M x x x KNIFE SPEED <input type="text" value="1"/> 2 3 HZ <input type="button" value="←"/> <input type="button" value="→"/> | |
| L1 | C x x x SENSOR INPUT <input type="button" value="←"/> <input type="button" value="→"/> | |
| L2 | M x x x REEL SPEED <input type="text" value="1"/> 2 3 HZ <input type="button" value="←"/> <input type="button" value="→"/> | |

(continued next page)

OPERATOR'S STATION

| | | | | | | | |
|--|---------|--|---------------------|--|---------|---|------------------|
| L1 | C x x x | | SENSOR INPUT | | ← | → | |
| L2 | M x x x | | WHEEL SPEED | | 1 2 3 | | H Z |
| NOTE: The oil temp. readout applies to the M205 model with the Sensata oil temp. sensor. | | | | | | | |
| L1 | C x x x | | SENSOR INPUT | | ← | → | |
| L2 | M x x x | | HYD OIL TEMP | | 1. 0 0 | | V |
| When "SELECT" is pressed the program goes to the EXIT READ SENSORS? menu | | | | | | | |
| L1 | C x x x | | EXIT READ SENSORS? | | | | |
| L2 | M x x x | | ← | | | | → |
| If "NO" then jump to: | | | | | | | |
| | | | SENSOR INPUT | | ← | → | |
| | | | HDR HEIGHT | | 3 . 5 9 | | V |
| If a sensor has been disabled "SENSOR" will be flashing in the area where the input reading would have been. | | | | | | | |
| L1 | C x x x | | SENSOR INPUT | | ← | → | |
| L2 | M x x x | | HDR HEIGHT | | | | SENSOR |
| L1 | C x x x | | SENSOR INPUT | | ← | → | |
| L2 | M x x x | | HDR ANGLE | | | | SENSOR |
| L1 | C x x x | | SENSOR INPUT | | ← | → | |
| L2 | M x x x | | 2 . 4 5 | | V | | FLOAT SENSOR |
| L1 | C x x x | | SENSOR INPUT | | ← | → | |
| L2 | M x x x | | KNIFE SPEED | | | | SENSOR |
| L1 | C x x x | | SENSOR INPUT | | ← | → | |
| L2 | M x x x | | REEL SPEED | | | | SENSOR |
| L1 | C x x x | | SENSOR INPUT | | ← | → | |
| L2 | M x x x | | HYD OIL TEMP | | | | SENSOR |
| NOTE: The oil temp. readout applies to the M205 model with the Sensata oil temp. sensor. | | | | | | | |
| L1 | C x x x | | ACTIVATE FUNCTIONS? | | | | |
| L2 | M x x x | | ← | | | | → |
| If "NO" then jump to: | | | | | | | |
| | | | FORCE HEADER TYPE? | | | | |
| L1 | C x x x | | ACTIVATE FUNCTIONS? | | | | |
| L2 | M x x x | | ← | | | | DOWN / UP |
| For diagnostic purposes each header function can be activated by using the "arrow" keys on the CDM. When "SELECT" is pressed the program will go to the next function that can be activated. | | | | | | | |
| L1 | C x x x | | ACTIVATE FUNCTIONS? | | | | |
| L2 | M x x x | | REEL | | ← | | DOWN / UP |
| If a disk header is detected then the nomenclature should read: DISC DRIVE instead of KNIFE DRIVE. | | | | | | | |
| L1 | C x x x | | ACTIVATE FUNCTIONS? | | | | |
| L2 | M x x x | | HDR TILT | | ← | | IN / OUT |
| PWM OPERATION: If the HAZARD switch is pressed instead of the TURN SIGNAL switch the GSL will operate the PWM valve (HAZARD sw must be held) and the PWM value will reset to zero when released. | | | | | | | |
| L1 | C x x x | | ACTIVATE FUNCTIONS? | | | | |
| L2 | M x x x | | DRAPER / AUGER | | ON | | |
| The DWA menu selection should only be available if the DWA INSTALLED? is set to YES. | | | | | | | |
| L1 | C x x x | | ACTIVATE FUNCTIONS? | | | | |
| L2 | M x x x | | REEL | | ← | | FORE / AFT |
| L1 | C x x x | | ACTIVATE FUNCTIONS? | | | | |
| L2 | M x x x | | DWA DRIVE | | ON | | |
| L1 | C x x x | | ACTIVATE HYD PURGE? | | | | |
| L2 | M x x x | | ← | | | | NO / YES |
| ACTIVATE HYD PURGE - This is to allow the operator to purge the air from a new or changed pump system. | | | | | | | |
| L1 | C x x x | | TO ACTIVATE PURGE | | | | |
| L2 | M x x x | | PRESS AND HOLD | | | | |
| L1 | C x x x | | PURGE CYCLE STARTED | | | | |
| L2 | M x x x | | PRESS AND HOLD | | | | |
| Pressing and holding the right hand "arrow" button activates a predetermined timed purge cycle. Releasing pressure on the switch or a completed cycle (timed out) will jump to the PURGE CYCLE ENDED menu selection. | | | | | | | |
| L1 | C x x x | | PURGE CYCLE ENDED | | | | |
| L2 | M x x x | | | | | | |
| L1 | C x x x | | PURGE CYCLE ENDED | | | | |
| L2 | M x x x | | ← | | | | NO EXIT YES |
| L1 | C x x x | | EXIT FUNCTION MENU? | | | | |
| L2 | M x x x | | ← | | | | NO / YES |
| If "NO" then jump to: | | | | | | | |
| | | | HEADER | | ← | | DOWN / UP |
| L1 | C x x x | | FORCE HEADER TYPE? | | | | |
| L2 | M x x x | | ← | | | | NO / YES |
| If "NO" then jump to: | | | | | | | |
| | | | EXIT DIAGNOSTICS? | | | | |
| L1 | C x x x | | SELECT HEADER TYPE | | | | |
| L2 | M x x x | | ← | | | | DISK HEADER |
| L2 | M x x x | | ← | | | | SK AUGER |
| L2 | M x x x | | ← | | | | DK AUGER |
| L2 | M x x x | | ← | | | | GRASS SEED |
| L2 | M x x x | | ← | | | | 2 0 FT SK DRAPER |
| L2 | M x x x | | ← | | | | 2 5 FT SK DRAPER |
| L2 | M x x x | | ← | | | | 3 0 FT SK DRAPER |
| L2 | M x x x | | ← | | | | 3 5 FT SK DRAPER |
| L2 | M x x x | | ← | | | | 1 5 FT DK DRAPER |
| L2 | M x x x | | ← | | | | 2 0 FT DK DRAPER |
| L2 | M x x x | | ← | | | | 2 5 FT DK DRAPER |
| L2 | M x x x | | ← | | | | 3 0 FT DK DRAPER |
| L2 | M x x x | | ← | | | | 3 5 FT DK DRAPER |
| L2 | M x x x | | ← | | | | 4 0 FT DK DRAPER |
| L1 | C x x x | | EXIT HEADER TYPE? | | | | |
| L2 | M x x x | | ← | | | | NO / YES |
| If "NO" then jump to: | | | | | | | |
| | | | FORCE HEADER TYPE? | | | | |
| L1 | C x x x | | EXIT DIAGNOSTICS? | | | | |
| L2 | M x x x | | ← | | | | NO / YES |
| If "NO" then jump to: | | | | | | | |
| | | | DIAGNOSTIC MODE? | | | | |

END

OPERATOR'S STATION

5.18.6 SETTING GUIDELINES

5.18.6.1 Pressure Settings

| HEADER MODEL | APPLICATION/SYSTEM | SUGGESTED OVERLOAD WARNING SETTING psi (kPa) | WINDROWER PRESSURE DIFFERENTIAL RELIEF SETTING psi (kPa) |
|----------------------|----------------------------|---|---|
| R80/R85 | Disc Pressure | 5000 (34474) | 5800 (39990) |
| D-SERIES A-SERIES | Reel/Draper Pressure | 3000 (20684) | 3500 (24132) |
| | Knife/Conditioner Pressure | 4000 (27579) | 4500 (31026) |

5.18.6.2 R Series Rotary Header Disc Speeds

| CROP | CONDITION | DISC RPM * |
|--|------------------|------------|
| Alfalfa | Heavy | 2100-2300 |
| | Light | 1800-2000 |
| Sudan, Sorghum, Haygrazer, Timothy | Tall & Stemmy | 2300-2500 |
| Short Grass | Dense | 2500 |
| | Thin | 2000-2200 |

* Suggested Overload Setting – 1300 rpm.

5.18.7 ENGINE ERROR CODES

The CDM displays “Error Codes” when there is a fault with one of the several sensors that monitor and control engine operation, to assist the operator or technician in locating a specific problem with engine operation. Refer to the Appendix for the “Error Codes”.

5.18.8 CDM & WCM FAULT CODES

The CDM displays “Fault Codes” when there is a fault with one of the several sensors that monitor and control windrower operation, to assist the operator or technician in locating a specific problem with the windrower. Refer to the Appendix for the “Fault Codes”.

WINDROWER OPERATION

6 OPERATION

6.1 OWNER/OPERATOR RESPONSIBILITIES















CAUTION

- It is your responsibility to read and understand this manual completely before operating the windrower. Contact your dealer if an instruction is not clear to you.
- Follow all safety messages in the manual and on safety signs on the machine.
- Remember that YOU are the key to safety. Good safety practices protect you and the people around you.
- Before allowing anyone to operate the windrower, for however short a time or distance, make sure they have been instructed in its safe and proper use.
- Review the manual and all safety related items with all operators annually.
- Be alert for other operators not using recommended procedures or not following safety precautions. Correct these mistakes immediately, before an accident occurs.
- Do not modify the machine. Unauthorized modifications may impair the function and/or safety and affect machine life.
- The safety information given in this manual does not replace safety codes, insurance needs, or laws governing your area. Be sure your machine meets the standards set by these regulations.











6.2 SYMBOL DEFINITIONS

The following symbols are used to depict functions or reactions at the various instruments and controls. Learn the meaning of these symbols before operating the Windrower.

6.2.1 ENGINE FUNCTIONS

| | | | |
|---|------------------------------|---|--------------------|
|  | Electrical Power-Accessories |  | Engine Stop |
|  | Engine Coolant Temperature |  | Engine Throttle |
|  | Engine Glow Plugs |  | Engine Urgent Stop |
|  | Engine Malfunction |  | Fast |
|  | Engine Rpm |  | Slow |
|  | Engine Run |  | Water In Fuel |
|  | Engine Start | | |

6.2.2 WINDROWER OPERATING SYMBOLS

| | | | |
|---|----------------------------------|---|-------------------------|
|  | Turn Signals |  | Windshield Wiper |
|  | Hazard Warning Lights |  | Seat Height Up |
| F | Forward |  | Seat Height Down |
| N | Neutral |  | Seat Fore and Aft |
| R | Reverse |  | Seat Fore Aft Isolator |
|  | Headlights Low Beam/Road Lights |  | Seat Back Fore and Aft |
|  | Headlights High Beam/Road Lights |  | Seat Ride Damping |
|  | Work Light |  | Cab Temperature Control |
|  | Lighter | | |

WINDROWER OPERATION

Windrower Operating Symbols (cont'd)



DWA Draper Speed



Air Conditioning



Fresh Air



Recirculate



Blower

6.2.3 HEADER FUNCTIONS



Program



Header Tilt Up



Header Index



Header Down



Return To Cut



Header Up



Conveyor/Auger Speed



Header Tilt Down



Float Left



Increase



Float Right



Decrease



Reel Speed



Deck Shift



Disc Speed



Float



Reel Down



Header Engage



Reel Forward



Header Disengage



Reel Up



Push Down Header Disengage



Reel Rearward



Pull Up Header Engage



Display Select



Header Reverse



DWA Down



DWA Up

WINDROWER OPERATION

6.3 WINDROWER OPERATION

6.3.1 OPERATIONAL SAFETY

Follow these safety precautions:



CAUTION

- Wear close fitting clothing and protective shoes with slip resistant soles.
- Remove foreign objects from the machine and surrounding area.
- As well, carry with you any protective clothing and personal safety devices that **COULD** be necessary through the day. **Don't take chances.**

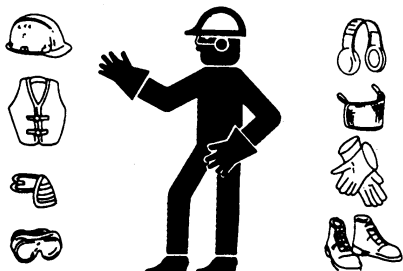

- You may need:
 - - a hard hat
 - - protective glasses or goggles
 - - heavy gloves
 - - respirator or filter mask
 - - wet weather gear
- Protect against noise. Wear a suitable hearing protective device such as ear muffs or ear plugs to protect against objectionable or uncomfortable loud noises. 
- Follow all safety and operational instructions given in your Operator's Manuals. If you do not have a windrower and/or combine manual, get one from your dealer and read it thoroughly.
- Never attempt to start the engine or operate the machine except from the operator's seat.
- Check the operation of all controls in a safe clear area before starting work.

- Check for excessive vibration and unusual noises. If there is any indication of trouble, shut down and inspect the machine. Follow proper shutdown procedure. Refer to Section 6.3.5.4 Shutdown Procedure.
- Operate only in daylight or good artificial light.

6.3.2 BREAK-IN PERIOD

The windrower is ready for normal operation. However there are several items to check and watch out for during the first 150 hours. In addition to the following, perform the items specified in to paragraph 7.13.1 Break-In Inspection Requirements.



DANGER

Before investigating an unusual sound or attempting to correct a problem, place **GSL** in **N-DETENT**, shut off engine, and remove key.

IMPORTANT

Until you become familiar with the sound and feel of your new windrower, be extra alert and attentive.

- Operate engine at moderate load and avoid extremely heavy or light loading for longer than 5 minutes.
- Avoid unnecessary idling. If engine will be idling for longer than 5 minutes after reaching operating temperature, turn key OFF to stop engine.
- Check engine oil level frequently. Watch for any signs of leakage. If oil must be added, refer to Section 7.8.3 Oil Level.

NOTE

During the break-in period, a higher than usual oil consumption should be considered normal.

NOTE

If windrower must be driven in cold weather (below freezing), let engine idle for 3 minutes, and then operate at moderate speed until oil has warmed up.

- Watch coolant gauge in cab for temperature rising beyond normal operating range. Check that coolant level at reserve tank (mounted next to radiator) stays between **HOT** and **COLD** marks on tank. Refer to Section 7.8.7.1 Cooling System. If over-heating problems occur, check for coolant leaks.

WINDROWER OPERATION

6.3.3 PRE-SEASON CHECK

- a. Perform the following safety checks at the beginning of each operating season:



CAUTION

- Review the Operator's Manual to refresh your memory on safety and operating recommendations.
 - Review all safety signs and other decals on the windrower and note hazard areas.
 - Be sure all shields and guards are properly installed and secured. Never alter or remove safety equipment.
 - Be sure you understand and have practiced safe use of all controls. Know the capacity and operating characteristics of the machine.
 - Store a properly stocked first aid kit and charged fire extinguisher on the windrower.
- b. Perform the following checks:
1. Drain off excess hydraulic oil added for storage. Refer to Section 7.11.3 Changing Hydraulic Oil.
 2. Remove plastic bags and/or tape from all sealed openings (air cleaner intake, exhaust pipe, fuel tank).
 3. Charge battery and install. Be sure terminals are clean and cables are connected securely.
 4. Adjust tension on A/C compressor belt. See Section 7.8.10.1 Tension.
 5. Cycle A/C switch to distribute A/C refrigerant oil.
- c. Perform annual maintenance. See Section 7.13 MAINTENANCE SCHEDULE.

6.3.4 DAILY CHECK

- a. Check the machine for leaks or any parts that are missing, broken, or not working correctly.

NOTE:

Use proper procedure when searching for pressurized fluid leaks. Refer to Section 7.11.7 Hoses And Lines.

- b. Clean the windows and mirrors to be sure of good visibility in all directions. Stand on the platform to access the rear window. Hold onto the hand-holds on the cab front corners and stand on the header anti-slip strips to wash the front window.
- c. Clean all lights and reflective surfaces to maintain visibility to others.
- d. Perform Daily maintenance. Refer to Section 7.13 MAINTENANCE SCHEDULE.

WINDROWER OPERATION

6.3.5 ENGINE OPERATION

6.3.5.1 Starting



DANGER

- Avoid possible injury or death from a runaway machine.
- This machine has safety devices which allow the engine to start only when the ground speed lever is in N-DETENT, the steering wheel is locked in the neutral position, and the header drive switch is in the OFF position. Under no circumstances are these devices to be deliberately rewired or misadjusted so that the engine can be started with controls out of neutral.
- Do not start engine by shorting across starter or starter relay terminals. Machine will start with drive engaged and move if normal starting circuitry is bypassed.
- Start engine only from operator's seat with controls in neutral. **NEVER** start engine while standing on ground. Never try to start engine with someone under or near machine.
- Before starting engine, be sure there is plenty of ventilation to avoid asphyxiation.

IMPORTANT

Do not tow machine to start engine. Damage to hydrostatic drives will result.



WARNING

Before starting engine, securely fasten your seat belt and ensure trainer's seat belt is fastened if occupied. The seat belt can help insure your safety if it is used and maintained.

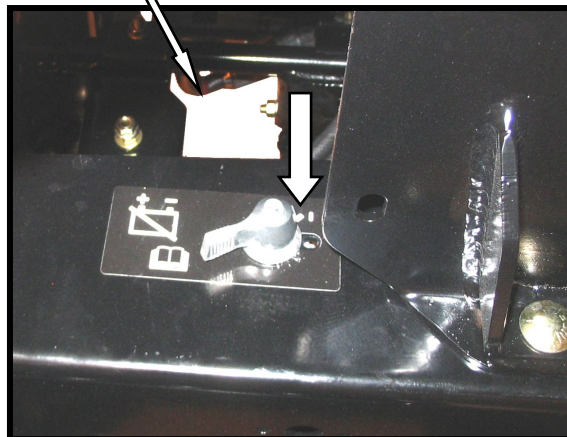

- a. A battery main disconnect switch is located on the RH frame rail, just behind the cab and can be easily accessed by raising the engine compartment hood. Ensure switch is switched to power on position.

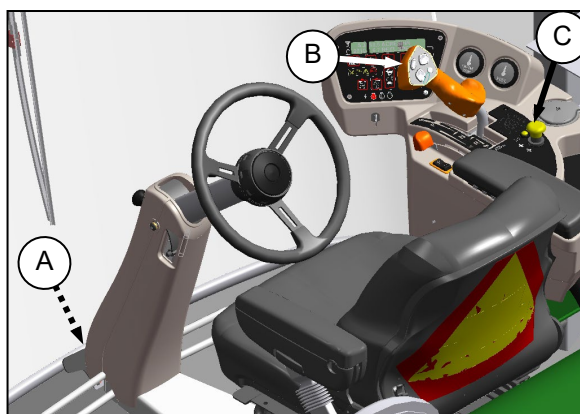

- b. Lock (A) must be engaged at cab-forward or engine-forward position.
- c. Move GSL (B) into **N-DETENT**.
- d. Turn steering wheel until it locks. It may be possible to move the steering wheel slightly in the locked position.

IMPORTANT

Do not attempt to force the wheel out of locked position as damage to the traction system may occur.

- e. Fasten seat belt.
- f. Push header drive switch (C) to off.

(continued next page)

WINDROWER OPERATION

- g. Normal Start - engine temperature above 60°F (16°C):



1. Set throttle (D) to start position – fully back.

IMPORTANT

The machine gauges and instruments provide important information about machine operation and condition. Familiarize yourself with the gauges and monitor them carefully during start-up operation. Refer to Section 5.15, ENGINE CONTROLS/GAUGES.



CAUTION

Be sure the area is clear of other persons, pets etc. before proceeding.

2. Sound horn three times.
3. Turn ignition key (E) to **RUN** position.
4. Single loud tone sounds, engine warning lights illuminate and CDM displays HDR DISENGAGED or HEADER ENGAGED and IN PARK.
5. Turn ignition key to **START** position until engine starts and then release key. Tone ceases and warning lights go out. CDM displays programmed header data for 5 seconds if attached and then returns to previous display.

IMPORTANT

Do not operate starter for longer than 15 seconds at a time. If engine does not start, wait at least two minutes before trying again. After the third 15 second crank attempt, allow solenoid to cool for 10 minutes before further cranking attempts. If engine still does not start, refer to Trouble Shooting section.



WARNING

If starter engages with steering wheel unlocked, ground speed lever out of neutral, or header clutch engaged, **DO NOT START ENGINE**. See your dealer.

- h. Cold Start - engine temperature below 40°F (5°C)
1. Follow procedure for Normal Start.
 2. Engine will cycle through a period where it appears to labour until engine warms up.

NOTE

Throttle is non-responsive during this time as engine is in "WARM UP" mode. This mode will last from 30 seconds to 3 minutes depending on temperature. After engine has stabilized and is idling normally, throttle becomes active.

IMPORTANT

Do not operate engine above 1500 rpm until engine temperature gauge is above 100°F (40°C).



WARNING

If starter engages with steering wheel unlocked, ground speed lever out of neutral, or header clutch engaged, **DO NOT START ENGINE**. See your windrower dealer.

6.3.5.2 Engine Warm-Up

Allow engine to run with throttle lever (D) at or near low idle position until temperature gauge reaches approximately 100°F (40°C).

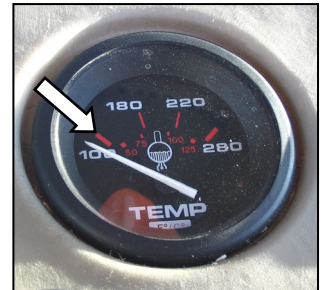

WINDROWER OPERATION

6.3.5.3 Engine Intermediate Speed Control (ISC)

The engine operating speed can be programmed to enable the windrower to operate at reduced engine rpm, i.e. **1800, 1900, 2000 rpm, OFF (full throttle)** without significantly affecting the ground or header speeds.

This is useful when operating loads are reduced such as in light crop conditions which do not require the maximum engine rpm. Reduced engine speed lowers fuel consumption, noise levels, and exhaust emissions in addition to reducing engine wear.

Programming instructions are given in Section 5.18.5 Cab Display Monitor (CDM) Programming. The programmed engine speed is activated when the header is engaged.

6.3.5.4 Shutdown



CAUTION

Be sure windrower is safely parked on a flat, level surface, header on the ground and the neutral lock/brakes are engaged.

IMPORTANT

Before stopping engine, run at low idle for approximately five minutes to cool hot engine parts (and allow turbocharger to slow down while engine oil pressure is available).

- a. Turn key counter-clockwise to OFF position.

6.3.5.5 Fueling



WARNING

- To avoid personal injury or death from explosion or fire, do not smoke or allow flame or sparks near fuel tank when refueling.



- **Never refuel the windrower when the engine is hot or running.**
 - a. Stop the windrower and remove key.
 - b. Stand on either platform to access the fuel tank filler pipe.

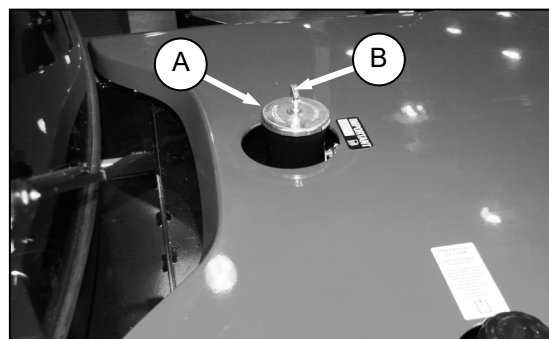

- c. Clean the area around the filler cap (A).
- d. Turn cap handle (B) counterclockwise until loose and remove cap.
- e. Fill tank with approved fuel as per table.

| FUEL | SPEC | SULPHUR (by weight) | WATER & SEDIMENT (by vol.) | CETANE NO. °C. | LUBRI CITY |
|--------------------------------------|---------------|-----------------------------------|----------------------------------|--|----------------|
| Diesel Grade No.2 | ASTM D-975 | 0.5% Max. | 0.05% Max. | 40 Min. | 520 microns |
| Diesel Grade No.1 & 2 mix * | n/a | 1% Max. 0.5% Max. Preferred | 0.1% Max. | 45-55 Cold Weather/ High Alt. | 460 microns |

- f. Replace fuel tank cap (A) and turn cap handle (B) clockwise until snug.

(continued next page)

WINDROWER OPERATION

NOTE

Fill fuel tank *daily*, preferably at the end of the day's operation to help prevent condensation in the tank. Tank Capacity is 97 U.S. Gallons (378 L).

IMPORTANT

Do not fill tank completely; space is required for expansion. A filled tank could overflow if exposed to a rise in temperature, such as direct sunlight.

IMPORTANT

Do not allow tank to empty. Running out of fuel can cause air locks and/or contamination of the fuel system. Refer to 7.8.6 Fuel System for priming procedures.

6.3.5.6 Engine Temperature

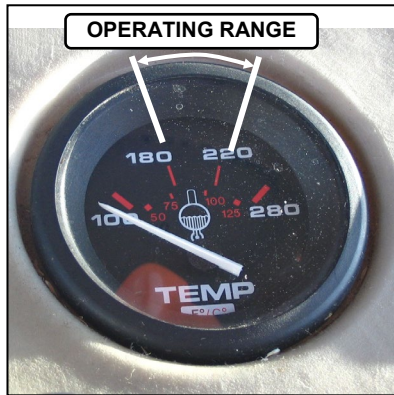

The normal engine operating temperature range is 180°-225°F (82°-107°C), and is indicated by a gauge on the operator's console. If the temperature exceeds 230°F (110°C), an ongoing intermittent tone will be heard and the CDM will flash "ENGINE TEMP". Stop the engine immediately and determine cause. The tone will stop and the CDM will return to normal when the temperature drops below 225°F (107°C).

6.3.5.7 Engine Oil Pressure

The nominal engine oil pressure is 10 psi (69 kPa) at low idle, and 55.1 psi (380 kPa) at maximum rated speed. If the oil pressure drops below 7.5 psi (52 kPa), a continuous loud tone will sound and the CDM display will flash "ENGINE OIL PRESS". Shutdown the engine immediately if warning occurs while operating or if it continues for more than a few seconds after engine startup.

6.3.5.8 Electrical

| IGNITION | ENGINE | READING | INDICATED CONDITION |
|----------|-------------------|--|------------------------------|
| On | Running | 13.8-15.0 | Normal |
| | | > 16.0 See Note | Regulator Out of Adjustment. |
| | <12.5 See Note | Alternator Not Working or Regulator Out of Adjustment. | |
| | Shutdown | 12.0 | Battery Normal. |

Note: Display flashes voltage reading with single loud tone. Repeats every 30 minutes until condition fixed.

The electrical system voltage is displayed on the CDM when selected with the select button on the GSL handle or the select switch on the CDM. The display indicates the condition of the battery and alternator. Refer to table.

6.3.5.9 Engine Warning Lights

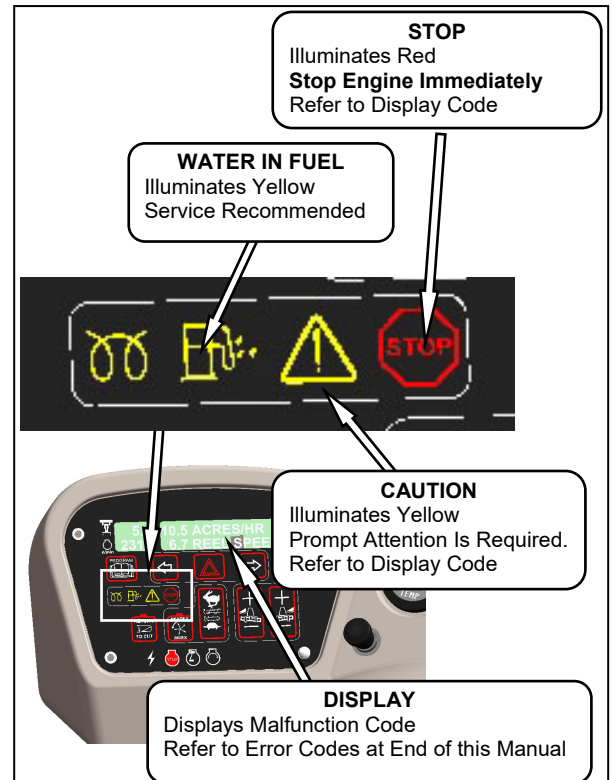

There are four engine warning lights that illuminate if abnormal conditions occur while the engine is running. The engine warning lights should not be illuminated under normal operating conditions.

WINDROWER OPERATION

6.3.6 DRIVING THE WINDROWER



WARNING

Before starting engine, securely fasten your seat belt and ensure trainer's seat belt is fastened if occupied. The seat belt can help insure your safety if it is used and maintained.



WARNING

- Avoid driving the machine with header removed. Removing header decreases the weight on drive wheels, reducing steering control.



- If necessary to drive machine with header removed, use transmission "field speed" range, do not exceed 1500 rpm engine speed and avoid loose gravel and slopes.
- Never use windrower as a towing vehicle when header is removed, except as instructed in Section 6.3.8.2 Towing Header with Windrower. There is insufficient weight on the drive wheels to provide steering control.
- Because of windrower shape characteristics, a roll-over protected (ROPS) cab is not required. If operating with header removed, be aware that the cab structure will not withstand a roll-over.



CAUTION

HYDROSTATIC STEERING

The machine is steered hydrostatically, that is, turning the steering wheel varies the hydraulic flow to one drive wheel relative to the other drive wheel. The reaction of this type of steering is different than conventional steering mechanisms.



CAUTION

With the engine running, moving the ground speed lever out of N-DETENT unlocks steering. Any movement of steering wheel will then cause the machine to move, even if the ground speed lever has not been moved forward or rearward from the neutral position.

Hydrostatic steering is more sensitive than mechanical steering.

Steering is opposite to normal when driving in reverse.

The brakes are only on when the GSL is in N-DETENT and the steering wheel is centered and locked.



DANGER

- Never move ground speed lever or steering wheel until you are sure all bystanders have cleared the area.

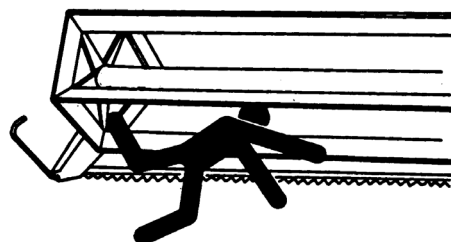

- Be sure area is clear before making turns, ends of header travel in a large arc.
- Check the operation of all controls in a safe, clear area before starting work. Be sure you know the capacity and operating characteristics of this machine.



- Do not allow riders in or on the machine.
- Operate only while seated in the operator's position.
- Never attempt to get on or off a moving windrower.
- Avoid sudden starts and stops.

(continued next page)

WINDROWER OPERATION

- Avoid inclines, ditches and fences.
- Do not rapidly accelerate or decelerate when turning
- Reduce speed before turning, crossing slopes, or travelling over rough ground.
- Do not allow anyone to stand behind the machine while operating. Foreign objects may be forcibly ejected.

6.3.6.1 Ingress/Egress



CAUTION

- To provide more secure hand and foot mobility, preventing slipping and possible injury, always face the windrower and use the hand rail when dismounting (or mounting).
- Never attempt to get on or off a moving windrower.
- Before leaving the operator's seat for any reason:
 - Park on level ground if possible.
 - Be sure ground speed lever is in N-DETENT and steering wheel is locked in the straight-ahead position.
 - Fully lower header and reel.
 - Disengage header drives.
 - Stop engine and remove key from ignition. A child or even a pet could engage an idling machine.
 - Turn off wipers.
 - Turn off lights unless required for inspection purposes.
 - Release seat belt.
 - Raise armrest and steering wheel for easier exit and re-entry.
 - Lock the cab door when leaving the windrower unattended. (When the door is locked, it can still be opened from inside the cab.)

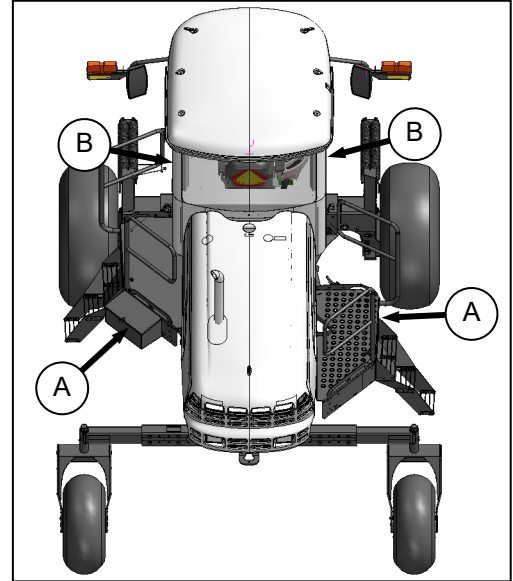

Swing away platforms and stairs (A) are provided on both sides of the windrower to accommodate cab-forward and engine-forward access to the operator's station as well as several maintenance tasks. The right cab-forward side platform is shown in the rearward (cab-forward) position.

Two doors (B) are provided for cab entry and exit in either cab-forward mode or engine-forward mode. Enter the cab using the door opposite the operator's console.

WINDROWER OPERATION

6.3.6.2 Cab-forward Operation



WARNING

Do not drive windrower on road in Cab-forward configuration, unless it is equipped with the proper lighting and markings for Cab-forward road travel.

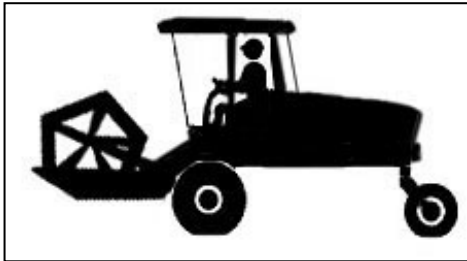

CAB-FORWARD – SEAT FACES HEADER
← DIRECTION OF TRAVEL

- a. Swivel operator's seat to cab-forward position as follows:

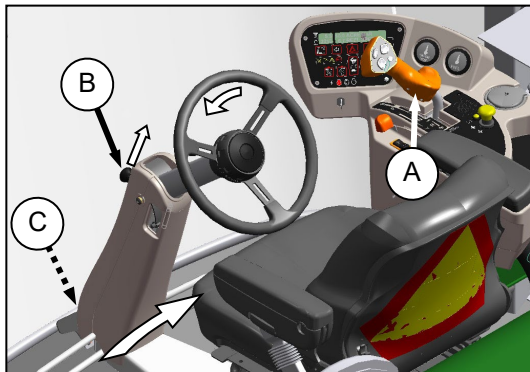

1. Place GSL (A) in **N-DETENT**. Engine can be running.

IMPORTANT

If GSL is not in N-DETENT, damage to the GSL cable may result when swivelling operator's station.

2. Pull up on knob (B) and hold to release latch (C) at base of steering column.
 3. Turn steering wheel counter-clockwise to pivot operator's station clockwise 180° until pin engages latch to secure operator's station in new position.
- b. Ensure seat belt is fastened.
 - c. Start engine if not running. Refer to Section 6.3.5.1 Starting.

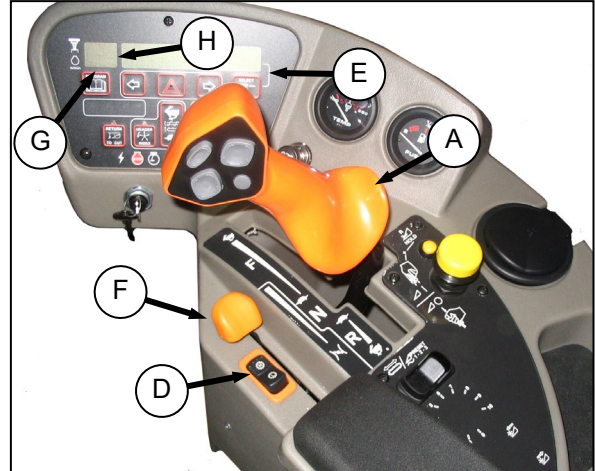

- d. There are two cab-forward speed ranges. Set ground speed range switch (D) to either **H** (0-16 mph (25.7 km/h)), or **L** (0-11 mph (17.7 km/h)).
- e. Slowly push throttle (F) to full forward (operating speed). CDM should display 2250-2340 RPM at (G).



CAUTION

Check again to be sure all bystanders have cleared the area.

- f. Slowly move the GSL (A) forward to desired speed which will be displayed at (H).



CAUTION

Operate both steering wheel and ground speed lever slowly for familiarization. Avoid the common tendency of new operators to over-steer.

- g. The windrower can be equipped with an automatic steering system for use in the field. The Auto-Steer is available as an option and can be installed by an Auto-Steer dealer. The GSL has been pre-wired at the factory with a switch. Also see Section 9.18 AUTO-STEER.

WINDROWER OPERATION

6.3.6.2.1 Reverse In Cab-forward Mode



WARNING

Back up slowly. Steering is opposite to normal when reversing. Hold steering wheel at the bottom and turn wheel in direction you want the rear (cab-forward) of the machine to travel.

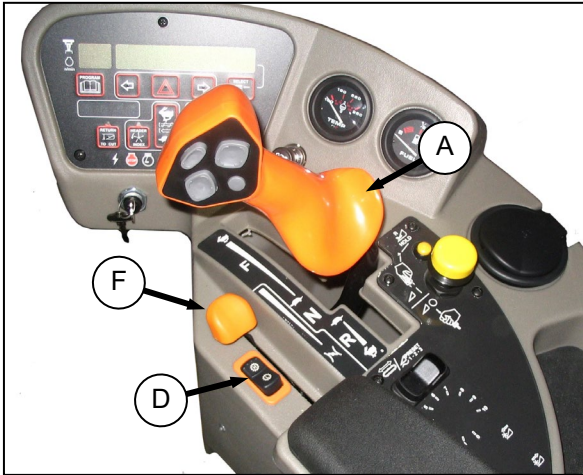

- a. Move speed-range switch (D) to L.
- b. Move throttle lever (F) to a mid-range position.

NOTE

Reversing in low speed-range and at reduced engine speed is recommended since steering will be less sensitive than at higher speed settings.



CAUTION

Check again to be sure all bystanders have cleared the area.

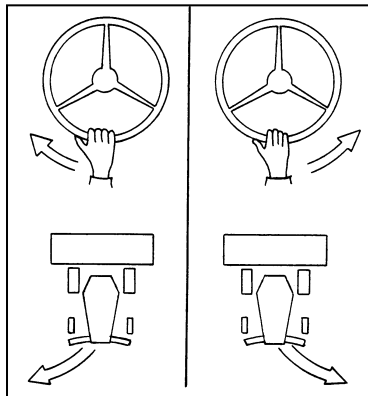

CAB FORWARD MODE

- c. Move the GSL (A) rearward to desired speed.
- d. Steer as shown.

6.3.6.3 Engine-forward Operation

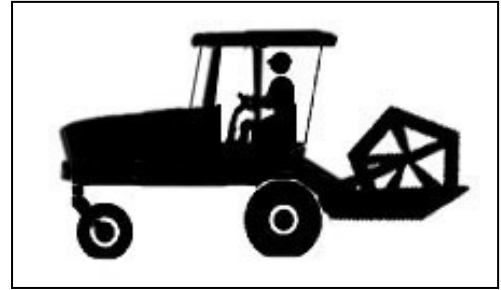

ENGINE-FORWARD – SEAT FACES ENGINE
DIRECTION OF TRAVEL

- a. Swivel operator's station to engine-forward position as follows:

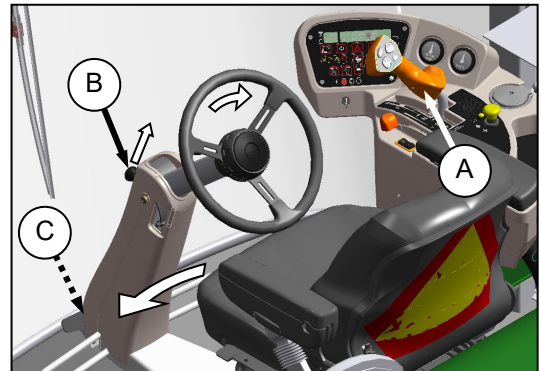

1. Place ground GSL (A) in N-DETENT and lock steering wheel. Engine can be running.

IMPORTANT

If GSL is not in N-DETENT, damage to the GSL cable may result when swivelling operator's station.

2. Pull up on knob (B) and hold to release latch (C) at base of steering column.
 3. Turn steering wheel clockwise to pivot operator's station counter-clockwise 180° until pin engages latch to secure operator's station in new position.
- b. Start engine if not running. Refer to Section 6.3.5.1 Starting.

(continued next page)

WINDROWER OPERATION

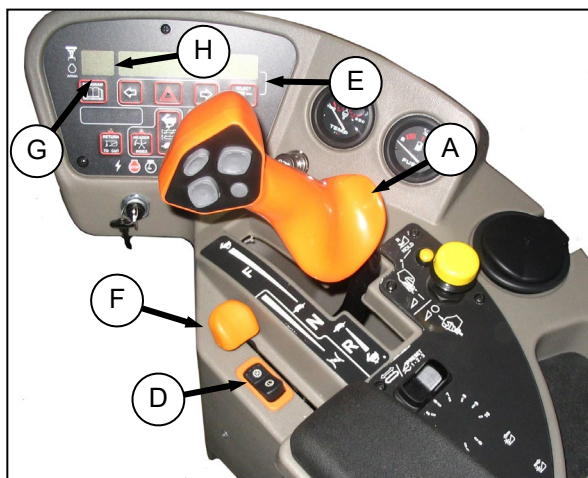

- c. Set ground speed range switch (D) to **H** for road speed (0-23 mph (37 km/h)). CDM will display ROAD GEAR at (E) and an alarm will briefly sound.
- d. Slowly push throttle (F) to full forward (operating speed). CDM should display 2250-2340 RPM at (G).



CAUTION

Check again to be sure all bystanders have cleared the area.

- e. Slowly move the GSL (A) forward to desired speed which will be displayed at (H).



CAUTION

Operate both steering wheel and ground speed lever slowly for familiarization. Remember that steering is more sensitive when speed-range control is in Road Speed Position. Avoid the common tendency of new operators to over-steer.

- f. When more tractive (lugging) power is required, for example, driving up a ramp, up a hill, or up out of a ditch:
 1. Move the GSL (A) closer to neutral.
 2. Switch speed-range control (D) to **L** (low range).
- g. Once condition as per f. no longer exists:
 1. Set GSL to not more than half maximum forward speed.
 2. Move speed-range control (D) to **H** (high range). Steering is more sensitive in this speed range.

6.3.6.3.1 Reverse In Engine-forward Mode



WARNING

Back up slowly. Steering is opposite to normal when reversing. Hold steering wheel at the bottom and turn wheel in direction you want the rear (cab-forward) of the machine to travel.



- a. Move speed-range switch (D) to **L**.
- b. Move throttle lever (F) to a mid-range position.

NOTE

Reversing in low speed-range and at reduced engine speed is recommended since steering will be less sensitive than at higher speed settings.



CAUTION

Check again to be sure all bystanders have cleared the area.

- c. Move the GSL (A) rearward to desired speed.
- d. Steer as shown.

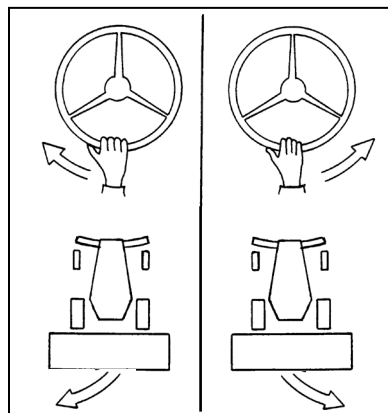

ENGINE-FORWARD MODE

WINDROWER OPERATION

6.3.6.4 Spin Turn

Hydrostatic steering gives the operator significantly more manoeuvrability than mechanical steering. To make a spin turn, refer to illustration and proceed as follows:



CAUTION

Be sure area is clear before making turns. Although windrower pivots "on the spot", ends of header travel faster and in a large arc.



- Move the GSL (A) out of N-DETENT towards the seat and hold.
- Slowly turn the steering wheel in the desired direction of turn. The windrower will pivot between the drive wheels.
- To stop the turn, slowly turn the steering wheel back to its centered position.
- To increase the turn radius, slowly move the GSL away from neutral. Remember that this will increase ground speed as well.
- To stop the turn, return the steering wheel to center.

6.3.6.5 Stopping



WARNING

Do not move ground speed lever rapidly back to neutral. Operator may be thrown forward by sudden stop. Always wear seat belt when operating windrower.



- SLOWLY return the GSL (A) to neutral and into N-DETENT.
- Turn steering wheel until it locks.
- Move throttle lever (F) to low idle position.

NOTE

Avoid unnecessary idling. Stop engine if it will be idling for longer than 5 minutes.

- Brakes are automatically engaged when steering wheel is locked in neutral position.



CAUTION

Park on a flat, level surface, header on the ground and the ground speed lever in N-DETENT and steering wheel locked.

IMPORTANT

Before stopping engine, run at low idle for approximately five minutes to cool hot engine parts (and allow turbocharger to slow down while engine oil pressure is available).

- Turn key counter-clockwise to OFF position.

WINDROWER OPERATION

6.3.7 ADJUSTABLE CASTER TREAD WIDTH

The rear casters can be adjusted to a narrow tread width to allow loading and shipping without having to remove them. A narrow tread width also suits smaller headers by allowing more space to the uncut crop and provides more maneuverability around poles, irrigation inlets, or other obstacles. A wider tread width is useful in heavy crops that produce large windrows so that turnover is reduced.

Adjust the caster tread width as follows:



CAUTION

Park on a flat, level surface, header on the ground and the ground speed lever in N-DETENT position and steering wheel locked.



DANGER

Stop engine and remove key from ignition before leaving operator's seat for any reason. A child or even a pet could engage an idling machine.

- a. Raise rear of windrower slightly so that most of the weight is off the casters, using a jack or other lifting device under the frame where shown.

NOTE

Lifting device should have a lifting

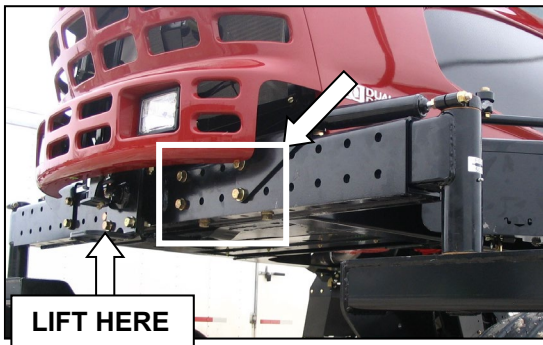

capacity of at least 5000 lb (2270 kg).

- b. Remove six bolts (four on backside, two on underside), and washers from left and right side of walking beam.

- c. Slide extensions inboard or outboard equal

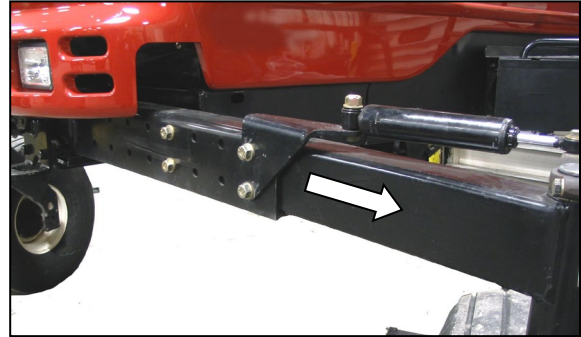

amounts, and align holes at desired location.

NOTE

Use the caster wheels to assist in moving the axle by rotating the caster so that

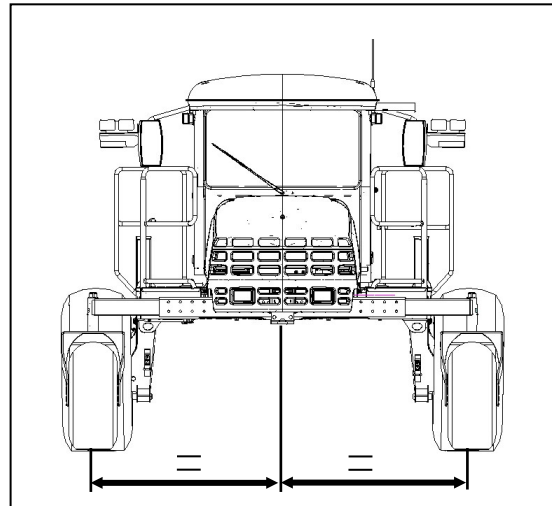

wheel is parallel to the axle.

NOTE

Illustration shows widest tread width.

IMPORTANT

Caster wheels must be equidistant from center of Windrower.

(continued next page)

WINDROWER OPERATION

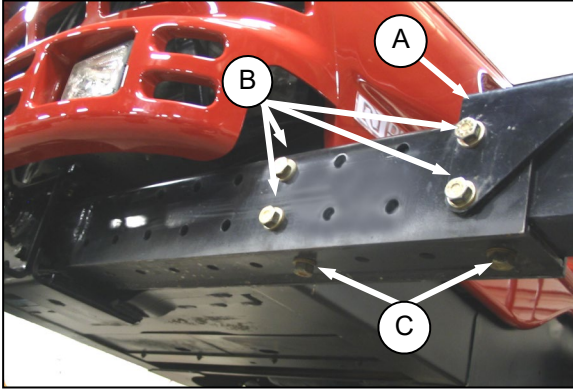

- d. Position bracket (A), and install bolts (B). The two shorter bolts are installed at the back inboard locations.
- e. Install bottom bolts (C).
- f. Tighten bolts as follows:
 1. Snug bottom bolts (C).
 2. Tighten and torque back bolts (B) to 330 ft·lbf (447 N·m).
 3. Tighten and torque bottom bolts (C) to 330 ft·lbf (447 N·m).
- g. Lower Windrower to ground.

IMPORTANT

Re-torque bolts after first 5, and 10 hours of operation.

WINDROWER OPERATION

6.3.8 TRANSPORTING

6.3.8.1 Driving On Road

The M205 Windrower is designed to be driven on the road with the engine-forward to provide better visibility for the operator and improved stability for the machine. Refer to Section 6.3.6.3, Engine-forward Operation. The windrower are capable of being driven on the road in cab-forward but at a reduced speed and under restricted conditions.

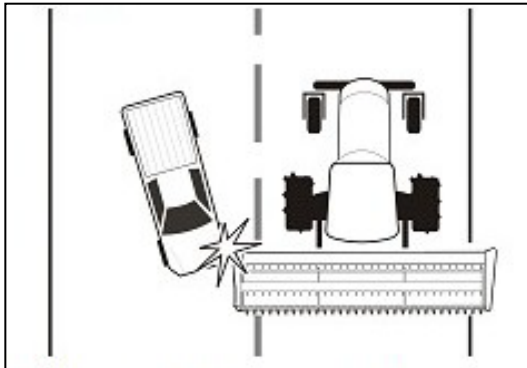

WARNING

Collision between windrower and other vehicles may result in injury or death.



WARNING

When driving windrower on public roadways:

- Obey all highway traffic regulations in your area. Use pilot vehicles front and rear of windrower if required by law.
- Use slow moving vehicle emblem and flashing warning lights unless prohibited by law.
- If width of attached header impedes other vehicle traffic, remove header and install a MacDon approved weight box.



CAUTION

Check local laws for width regulations and lighting and marking requirements before transporting on roads.



WARNING

- Do not drive windrower on the road in the cab-forward mode, unless the optional lighting marking kit is installed, as lighting/reflector visibility will not be compliant with road regulations. See Section 5.7.3.
- Do not drive windrower on a road or highway at night, or in conditions which reduce visibility, such as fog or rain. The width of the windrower may not be apparent under these conditions.



CAUTION

Operate both steering wheel and ground speed lever slowly for familiarization. Remember that steering is more sensitive when speed-range control is in Road Speed Position. Avoid the common tendency of new operators to over-steer.



- a. Ensure HEADER DRIVE switch is pushed to off position.
- b. Before driving windrower on a roadway:
 1. Clean flashing amber lamps, red tail lamp and head lamps and check that they work properly.
 2. Clean all reflective surfaces and slow moving vehicle emblems.
 3. Adjust interior rear view mirror and clean windows.

(continued next page)

WINDROWER OPERATION



- c. Push LIGHT switch to ROAD position to activate lamps. Always use these lamps on roads to provide warning to other vehicles. Use HI / LO LIGHTS as required when other vehicles are approaching. Do not use field lamps on roads, other drivers may be confused by them.
- d. Push BEACON switch to on to activate beacons (North America optional).

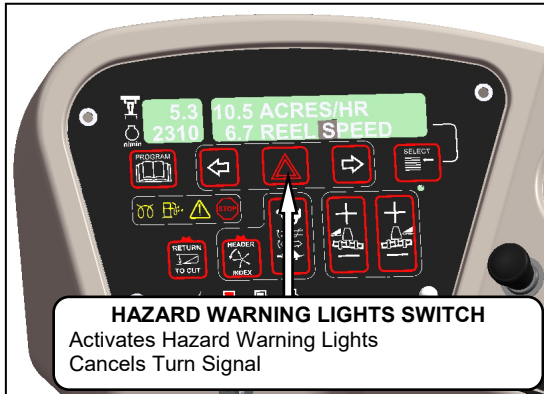

- e. Press switch on CDM to activate hazard lights (Export optional).
- f. Set ground speed range switch (A) for road speed. CDM will display ROAD GEAR at (B) if windrower is in engine-forward mode.

NOTE

Windrower can be moving but speed must be less than 5 mph (8 km/h) for road gear to engage.

- g. Slowly push throttle (C) to full forward (operating speed). CDM should display 2250-2340 RPM (D).
- h. Slowly move the GSL (E) forward to desired speed which will be displayed at (F).
- i. If towing a header, refer to Section 6.3.8.2 Towing Header with Windrower.



WARNING

To avoid serious injury or death from loss of control:

- Do not make abrupt changes in steering direction.
- Anticipate turns and steep slopes by slowing down well in advance.
- Do not rapidly accelerate or decelerate while turning.
- When travelling on steep slopes:
 - i) Move ground speed lever closer to neutral to reduce speed.
 - ii) Lower header.
 - iii) Move GROUND SPEED RANGE switch to low range.
 - iv) If the ground speed is greater than or equal to 25 mph (40 km/h), the CDM will display a warning message (SLOW DOWN) with an audible alert. Move GSL closer to neutral to reduce speed.
- With header removed, steering control is reduced if weight is not added to drive wheels. If you must drive the windrower without header or MacDon weight system;
 - Operate in low speed range.
 - Do not exceed 1500 rpm engine speed.
 - Avoid loose gravel and slopes.
 - Do not tow a header.
 - If control of machine is lost, immediately pull ground speed lever to neutral.

WINDROWER OPERATION

6.3.8.2 Towing Header with Windrower



WARNING

Harvest Header with Transport Option

The windrower without the header must not be used to tow headers due to reduced traction and possible loss of control unless the Weight Box option is installed on the windrower, or a header transporter that transfers weight to the lift arms.

For towed equipment without brakes, do not exceed 20 mph (32 km/h).

The windrower can be used to tow a MacDon Harvest Header with the Slow Speed Transport option installed, provided the Weight Box option is installed on the windrower, or an approved header transporter with weight transfer to the lift arms.

6.3.8.2.1 From Field to Transport Mode

- a. Set header on the ground (field position).



DANGER

Stop engine and remove key from ignition before leaving operator's seat for any reason. A child or even a pet could engage an idling machine.

- b. Disconnect hydraulic and electrical connections:
1. Left Side - Store hydraulic hoses and electrical cable into the storage position. See Header Operator's Manual.
 2. Right side – Release the multi link and place into storage on windrower. See Header Operator's Manual.

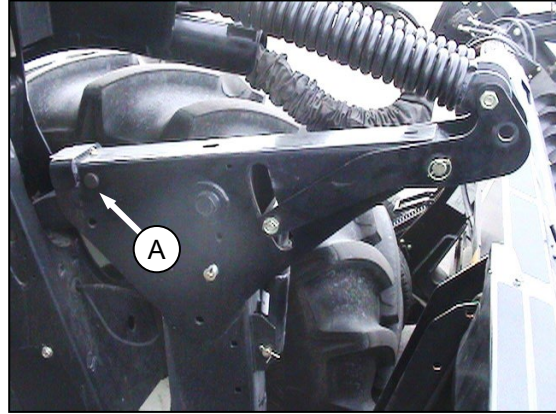

- c. Retrieve temporary lift pin from storage location on weight box and install into rear hole (A) at the top of the lift arms for additional lift height for transport wheel deployment.



DANGER

To avoid bodily injury from fall of raised header, always engage header lift cylinder stops when working on or around raised header.

- d. Raise header to full height, stop engine, and engage safety locks on lift cylinders.



- e. Deploy header slow speed transport system. See Header Operator's Manual.

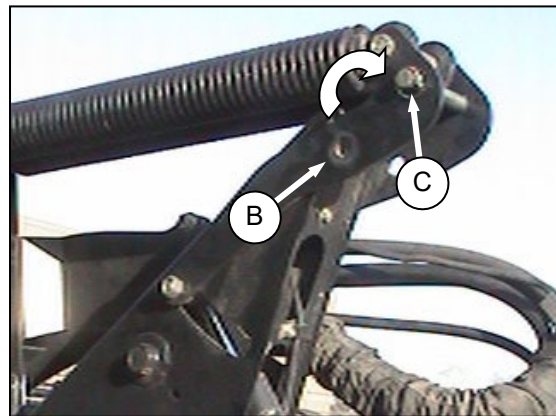

- f. Remove float pin from engaged position (B) and insert in storage location (C). Secure with lynch pin.

(continued next page)

WINDROWER OPERATION

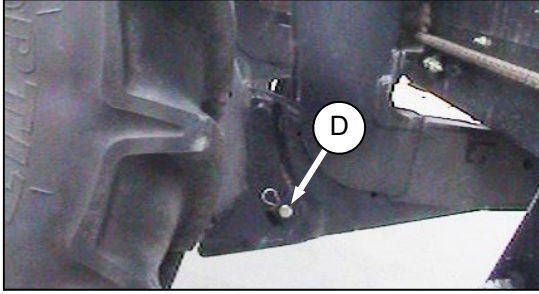

- g. Remove pins (D) from lower end of lift linkages.

NOTE

Pins (D) are also used to secure weight box to windrower linkage.

- h. Release the safety lock on the header lift cylinders.
 i. Start engine and lower header down onto the transport wheels.

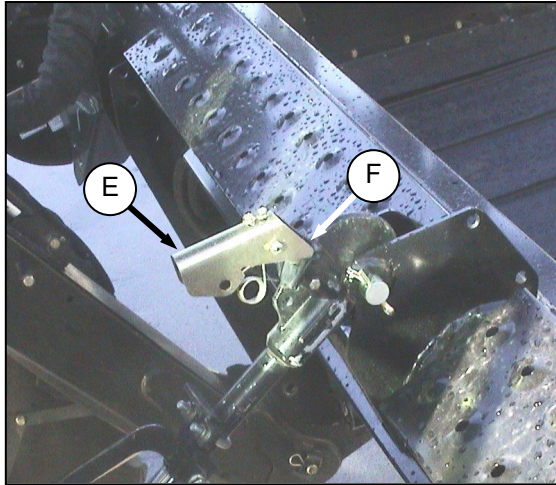

D60 SHOWN

- j. Pull up on center-link latch (E) and locate latch into notch (F) on top of hook.

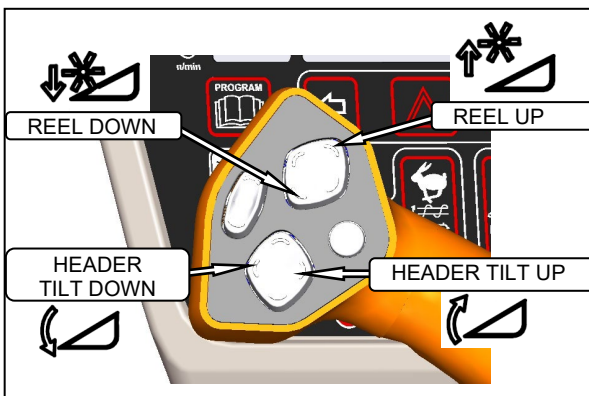

- k. Use the HEADER TILT switches to release load on the cylinder if necessary.

- l. Raise the center-link off the header using the REEL UP switch on the GSL.
 m. Slowly back windrower away from header, shut off engine and remove key from ignition.
 n. Attach header transport hitch to header as follows:

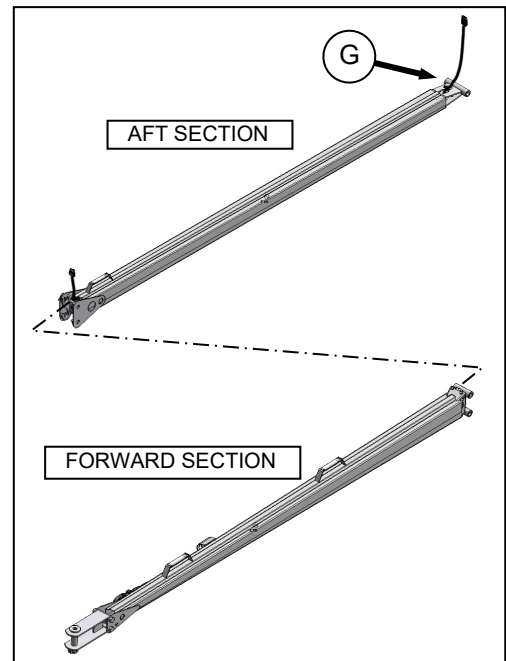
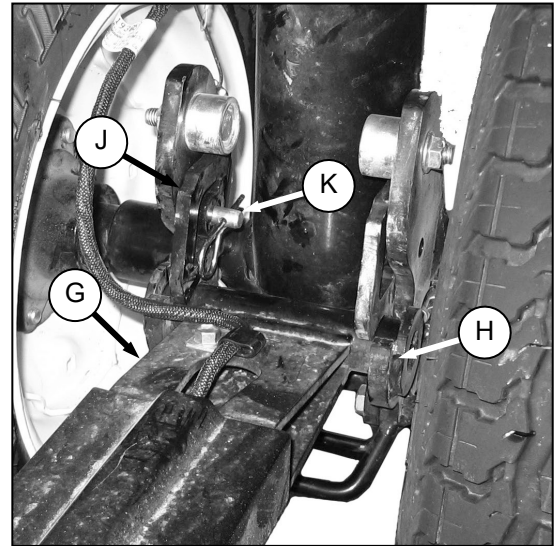

1. Position end (G) of the aft section onto front wheel hook (H).
2. Push down until latch (J) captures the end (G).
3. Secure latch (J) with clevis pin (K).

(continued next page)

WINDROWER OPERATION

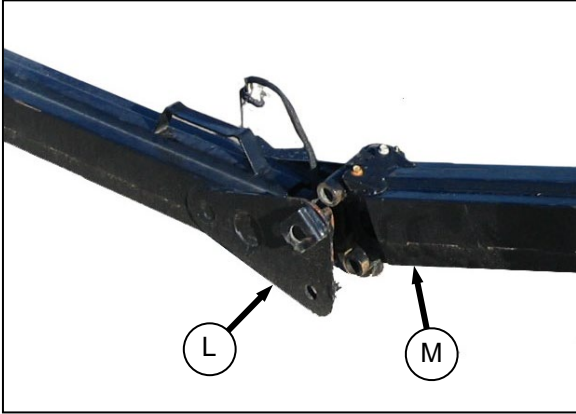

4. Remove the L-pin from end (L) of aft section if installed.

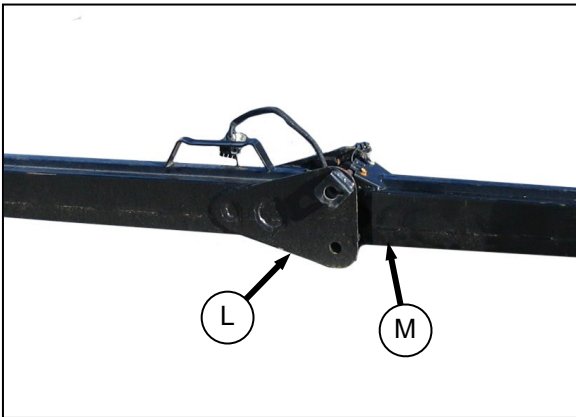

5. Position end (M) of the forward section into end (L) of the aft section.

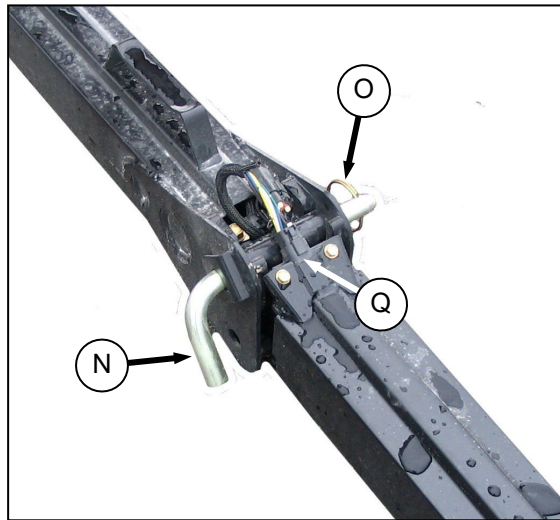

6. Lower forward section into aft section.
7. Fully insert L-pin (N) in upper hole and turn pin to lock it. Secure with ring pin (O)



8. Make the electrical connection at the joint (Q) and at the header wheel (P).

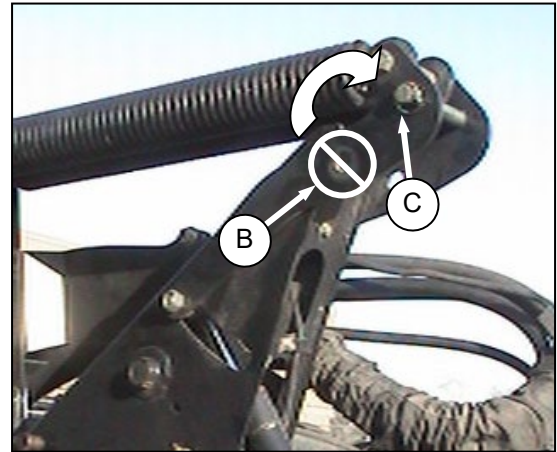

IMPORTANT

To prevent damage to the lift system when lowering header lift linkages without a header or weight box attached to windrower, ensure that float engagement pin is installed in storage location (C), and **not** installed at hole location (B).

(continued next page)

WINDROWER OPERATION

- o. Drive windrower so that windrower lift arms are positioned into the weight box pockets.

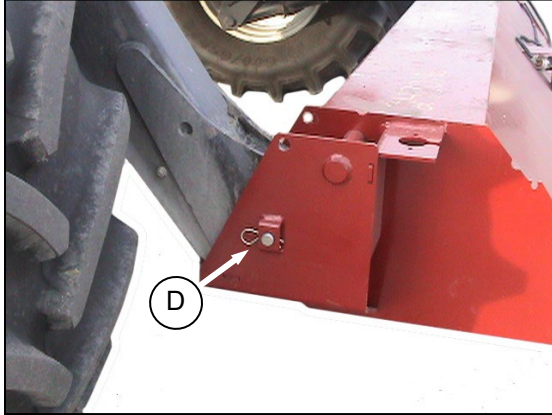

- p. Raise lift arms slightly and install locking pins (D) into pockets and thru windrower header lift linkages. Secure with hairpin.

NOTE

Pins (D) were previously removed from the header lift linkage lower end.

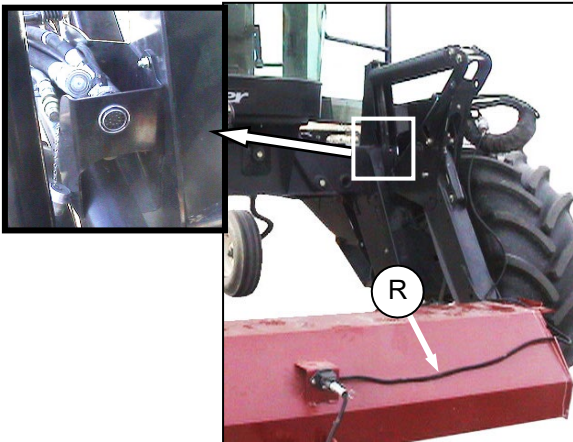

- q. Route the weight box harness (R) to the electrical connector at the left side lift linkage and connect harness to connector.

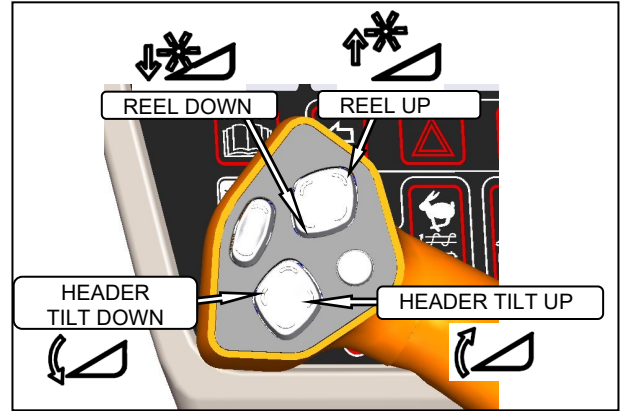
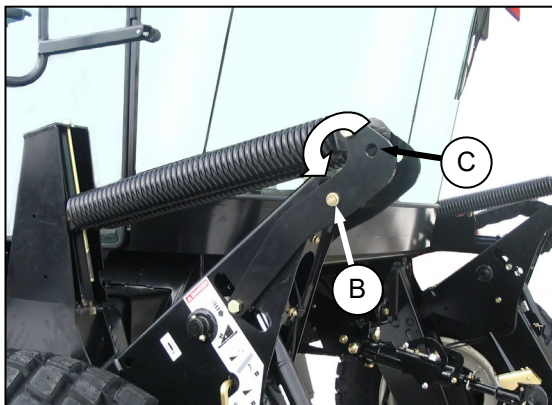

- r. Raise lift arms fully, shut off engine, and remove key from ignition.
- s. Move float pins from storage location (C) to engaged position (B).
- t. Start engine and press HEADER DOWN switch on GSL to lower lift arms until the lift arm “floats” up away from the linkage at the rear of the lift arm.

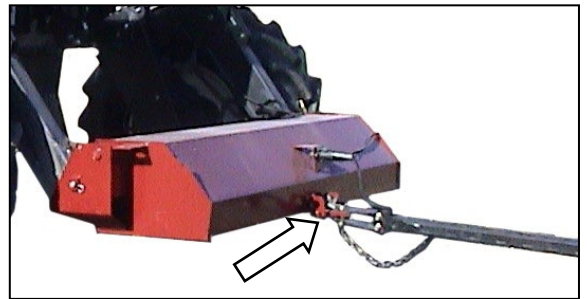

- u. Attach slow speed transport hitch to the weight box tongue with drawbar pin (secure using lynch pin). Attach safety chain.
- v. Connect hitch harness to electrical socket at front of weight box.

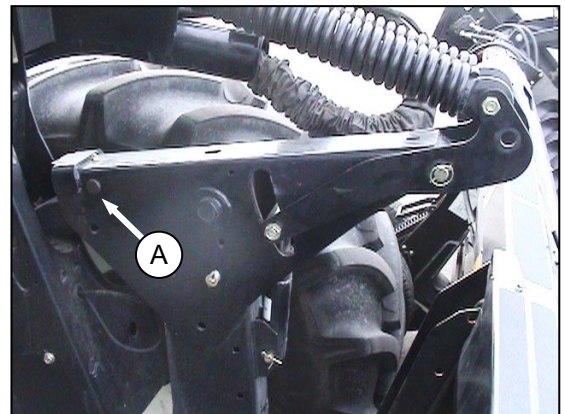

- w. Remove the temporary lift pins (A) (should be loose in lift arm) and place into storage holes on weight box.

WINDROWER OPERATION

6.3.8.2.2 From Transport Mode To Field Operation



DANGER

Stop engine and remove key from ignition before leaving operator's seat for any reason. A child or even a pet could engage an idling machine.

- a. Shut down engine and remove key from ignition.

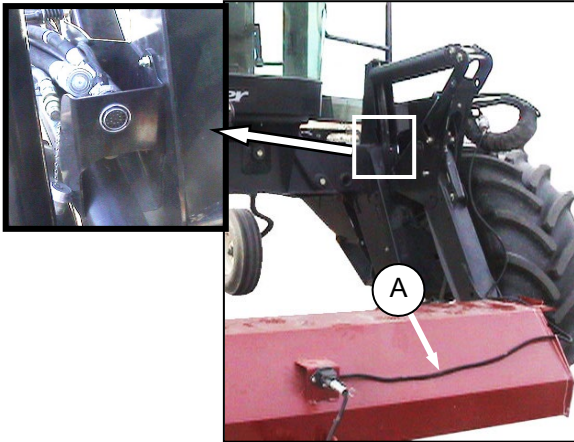

- b. Disconnect electrical harness from windrower and store harness (A) on weight box.



- c. Disconnect wiring connector (B) at front wheel.

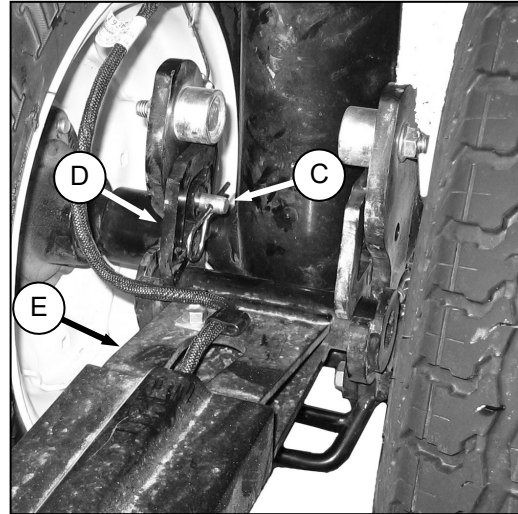

- d. Remove clevis pin (C).
- e. Push latch (D) and lift tow-bar (E) from hook. Release latch and replace clevis pin.
- f. Unhook tow-bar from weight box.
- g. Start engine and lower lift arms until rear of lift arms floats up and away from the lift arm mechanism.
- h. Stop engine and remove key from ignition.

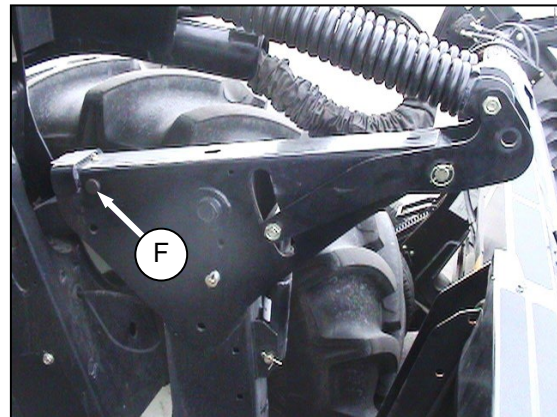

- i. Remove temporary lift pins (F) from weight box and install pins (F) into holes at rear of lift arms.
- j. Start engine and fully raise lift arms. Stop engine and remove key from ignition.
- k. Engage lift cylinder stops.

(continued next page)

WINDROWER OPERATION

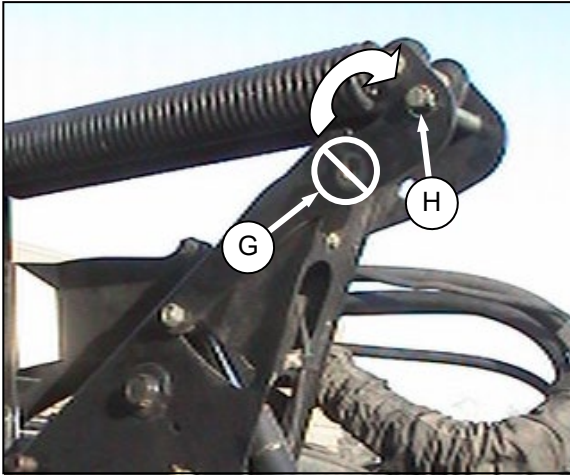

- I. Move float pins from location (G) to disengage the float and store pins at location (H).

IMPORTANT

To prevent damage to the lift system when lowering header lift linkages without a header or weight box attached to windrower, ensure that float engagement pin is installed in storage location (H), and **not** installed at hole location (G).

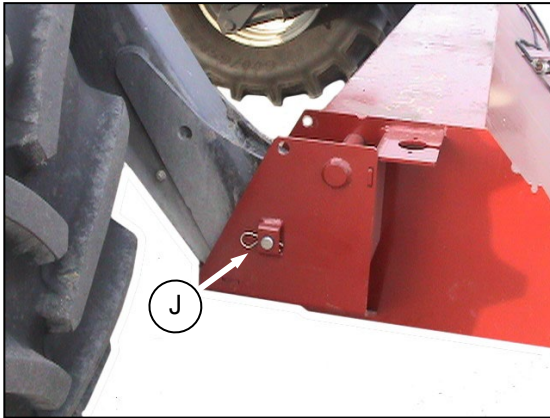

- m. Remove pins (J) securing lift linkages to weight box, and retain pins for attaching header to windrower. Disengage lift cylinder locks.
- n. Start engine, lower weight box onto blocks and back away.
- o. Attach header to windrower. Refer to Section 6.5.1 Header Attachment.
- p. Convert header into field position. See Header Operator's Manual for procedure.

WINDROWER OPERATION

6.3.8.3 Towing the Windrower

In emergency situations, for example, towing out of a field or into a shop, windrower may be towed without a trailer, providing the following precautions are followed:



WARNING

A proper towing apparatus is critical to safe towing. Use the following guidelines:

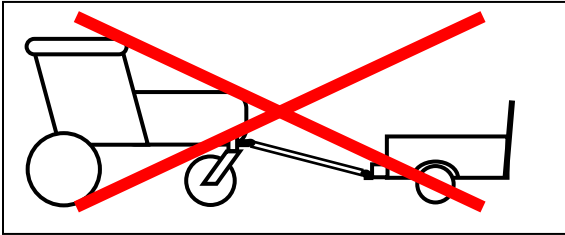

- Do not attach directly from hitch to walking beam. Slope of tow bar will not provide proper transfer of braking force

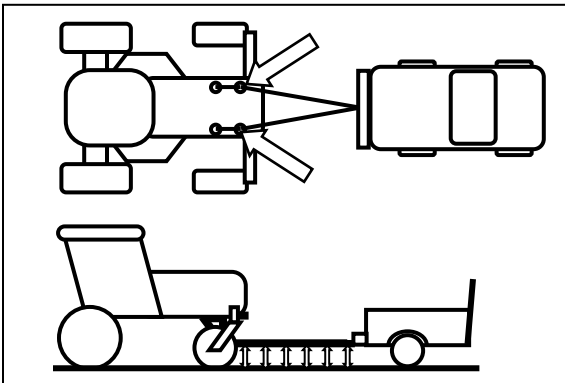

to windrower, causing loss of control.

- For proper steering, towing apparatus should be attached to both left and right hand frame members and should attach to tow bar at same height as towing vehicle hitch.
- Towing apparatus should be removed for field operation, to avoid interference with windrow.



WARNING

With final drives disengaged, the windrower may roll on a sloped surface. Before disengaging final drives, attach windrower to towing vehicle. After towing, engage drives and ensure GSL is in N-DETENT before detaching from towing vehicle.

IMPORTANT

Failure to disengage final drives before towing will result in serious transmission damage.

IMPORTANT

Do not exceed 16 mph (26 km/h) when towing windrower. Do not use this towing method for normal transporting of windrower. Even with final drives disengaged, rolling speeds of more than 16 mph (26 km/h) will cause final drive gears to run at excessive speeds, possibly severely damaging or causing the unit to fail.

WINDROWER OPERATION

6.3.8.4 Final Drives

Disengage and engage final drives as follows:

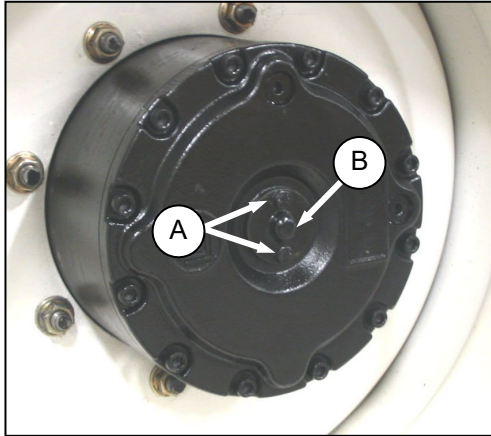

- Remove the two hex bolts (A) at center of drive wheel.
- Remove cap (B) and flip over so that dished side faces in. The cap depresses a pin which disengages the gearbox.
- After towing, reverse cover (A) to re-engage final drives. Be sure plunger at center of wheel pops out to engage drive.

6.3.9 STORAGE

At the end of each operating season:

- Clean the windrower thoroughly.



WARNING

Never use gasoline, naphtha or any volatile material for cleaning purposes. These materials are toxic and/can be flammable.

- Store windrower in a dry protected place.



CAUTION

Never operate engine in a closed building. Proper ventilation is required to avoid exhaust gas hazards.

- Remove the battery. Refer to Section 7.10.1.6 Replacing Battery.
- Bring to full charge and store in a cool, dry place not subject to freezing.



CAUTION

Remember when working around storage batteries that all of the exposed metal parts are "live". Never lay a metal object across the terminals because a spark and short circuit will result.

- If stored outside, always cover windrower with a waterproof tarpaulin or other protective material. This will protect the switches, instruments, tires, etc. from inclement weather.
- If no cover is available; seal air cleaner intake and exhaust pipe with plastic bags and/or waterproof tape.
- If possible, block up windrower to take weight off tires. If it is not possible to block up the machine, increase tire pressure by 25% for storage. Adjust to recommended operating pressure before next use.
- Repaint all worn or chipped painted surfaces to prevent rust.
- Lubricate the windrower thoroughly, leaving excess grease on fittings to keep moisture out of bearings. Apply grease to exposed threads and sliding surfaces of components.
- Check for worn components and repair. Tighten loose hardware and replace any missing hardware. See Specifications section for torque charts.
- Check for broken components and order replacements from your dealer. Attention to these items right away will save time and effort at beginning of next season.
- Add approved rust inhibitor to the engine oil in accordance with the manufacturer's instructions. Run engine to operating temperature to mix inhibitor with oil, unless otherwise specified.
- To prevent condensation, fill hydraulic oil reservoir to filler neck with approved hydraulic system oil. Refer to Section 7.11 OIL LEVEL.
- Test engine coolant anti-freeze concentration to ensure it is sufficient to protect engine against lowest expected temperature.

HEADER – GENERAL

6.4 HEADER OPERATION

The M205 Windrower is designed to use the MacDon A-Series Auger Header, R-Series Rotary Header, and D-Series Rigid Draper header with or without a Hay Conditioner. This section describes the attachment and detachment procedures and operating instructions for these header types.

6.4.1 HEADER LIFT CYLINDER STOPS

Cylinder stops are located on both header lift cylinders on the windrower. To avoid bodily injury or death from fall of raised header, always engage cylinder stops before going under header for any reason. Engage cylinder stops as follows:

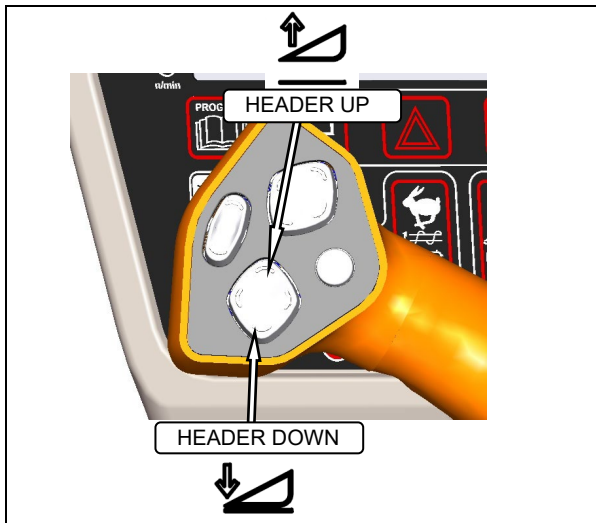

- a. Press HEADER UP switch to raise header to maximum height.

NOTE

If one end of the header does not raise fully, the lift cylinders require re-phasing. Proceed as follows:

1. Press and hold the HEADER UP switch until both cylinders stop moving.
2. Continue to hold the switch for 3-4 seconds.
3. Cylinders are phased.

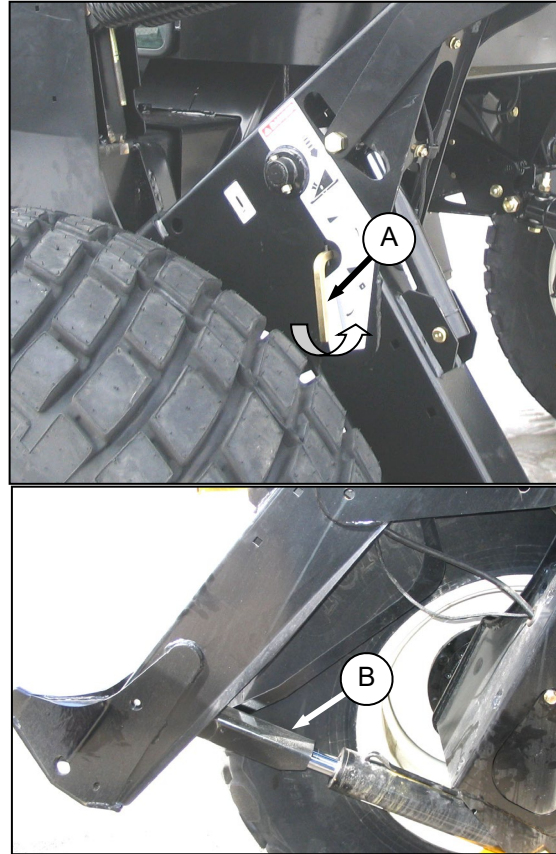

- b. Pull lever (A) and rotate toward header to release and lower cylinder stop (B) onto cylinder. Repeat for both lift cylinders.
- c. To store, turn lever (A) away from header to raise stop until lever locks into vertical position.

HEADER – GENERAL

6.4.2 HEADER FLOTATION

Float is intended for cutting crops that require the cutterbar to be in contact with the ground. Optimum float is for the cutterbar to maintain contact with the ground with minimum bouncing and scooping or pushing soil.

The machine will perform best with minimum extra weight on the header.

IMPORTANT

To avoid frequent breakage of sickle components, scooping soil, or soil build-up at cutterbar in wet conditions, header float should be set as light as possible without causing excessive bouncing. When float setting is light, it may be necessary to use a slower ground speed to avoid excessive bouncing and leaving a ragged cut.

IMPORTANT

The stabilizer wheels are designed to minimize bouncing at the header ends and not “float” the header. Refer to the D50 and D60 Harvest Headers for Self-Propelled Windrowers Operator’s Manual (Form #169441) for adjustment details.

6.4.2.1 Float Operating Guidelines

When working with the cutterbar on the ground;

- Set center link to mid-range position (05.0 on CDM). Refer to Section 6.4.5 Header Angle.
- In rocky fields, adjust skid shoes down to raise guards when operating at flattest header angle to minimize scooping rocks.
- Adjust header height or adjust header angle to minimize pushing soil.

6.4.2.2 Float Adjustment

The M Series windrowers are equipped with primary (coarse) and secondary (fine) adjustment systems. The primary or coarse adjustment uses drawbolts to change the tension on the springs in the lift linkages. The secondary or fine adjustment uses hydraulic cylinders to change the spring tension.

- a. Check header float as follows:



CAUTION

Check to be sure all bystanders have cleared the area.

1. Start the engine.

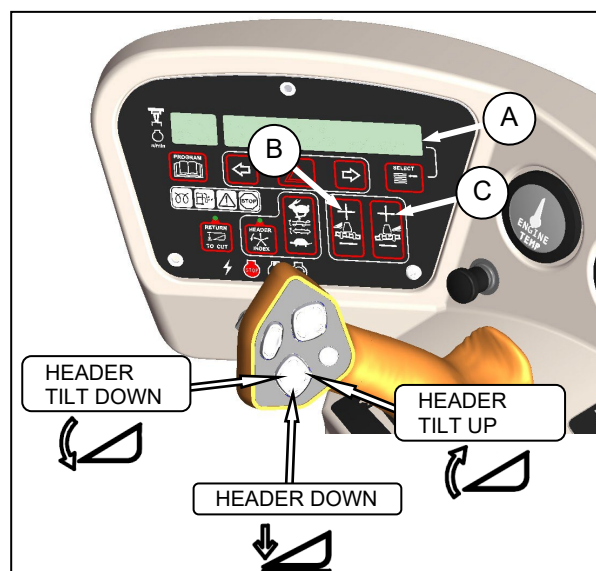

2. Using HEADER TILT SWITCHES, set center link to mid-range position (05.0 on CDM) (A).
3. Using HEADER DOWN switch, lower header fully with lift cylinders fully retracted.
4. Set left and right float fine adjustments on the CDM to approximately 5.0 as follows:
 - i) Using float selector switch (B), push + to increase float, or – to decrease float on left side of header. CDM display (A) will indicate selected float for left side, for example (5.0 L FLOAT R XX.X).
 - ii) Repeat for right side float with switch (C). Display will indicate float for both sides, for example (5.0 L FLOAT R 5.0).
5. Shut down engine and remove key.

(continued next page)

HEADER – GENERAL



DANGER

Stop engine and remove key from ignition before leaving operator's seat for any reason. A child or even a pet could engage an idling machine.

- Grasp the divider rod and lift. The force to lift should be as noted in the following table, and should be approximately the same at both ends.

| HEADER | FORCE TO LIFT CUTTERBAR AT ENDS WITH LIFT CYL FULLY RETRACTED |
|--------|--|
| Auger | 75-85 lbf (335-380 N) |
| Rotary | 95-105 lbf (426-471 N) |
| Draper | 75-85 lbf (335-380 N) With Stabilizer/Transport Wheels Raised (if equipped). |

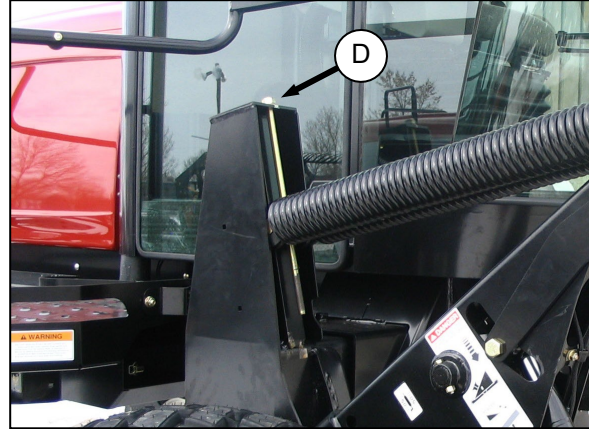

- Turn drawbolt (D) clockwise to increase float (makes header lighter) or counterclockwise to decrease float (makes header heavier).
- Recheck the float as described on previous page.

- If necessary, coarse adjust the float with the drawbolts as follows:



CAUTION

Check to be sure all bystanders have cleared the area.

- Start engine.

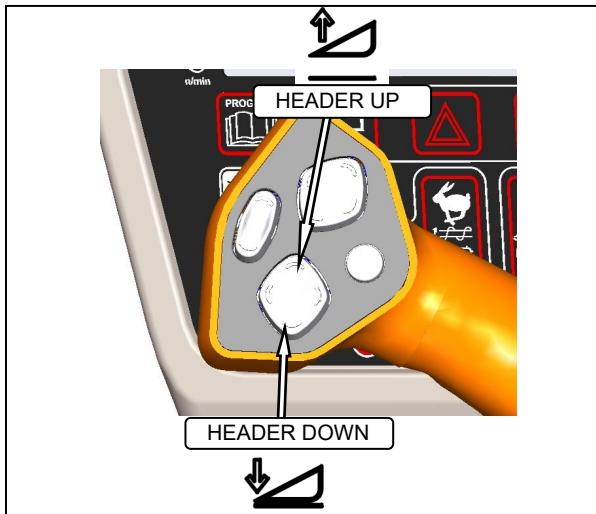

- Using HEADER UP switch on GSL, Raise the header fully, shut down the engine, and remove the key.

HEADER – GENERAL

6.4.2.3 Float Options

For draper headers without the deck shift option, auger headers, and rotary headers, the float can be pre-programmed for three types of windrowing conditions. For example;

- Position 1 – Border
- Position 2 – Normal
- Position 3 – Rocky

Set float pre-sets as follows:

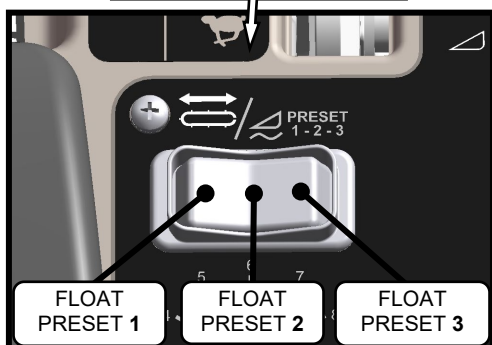

- Engage header.
- Push float preset switch to position 1.
- Using HEADER TILT SWITCHES, set center link to mid-range position (05.0 on DISPLAY).

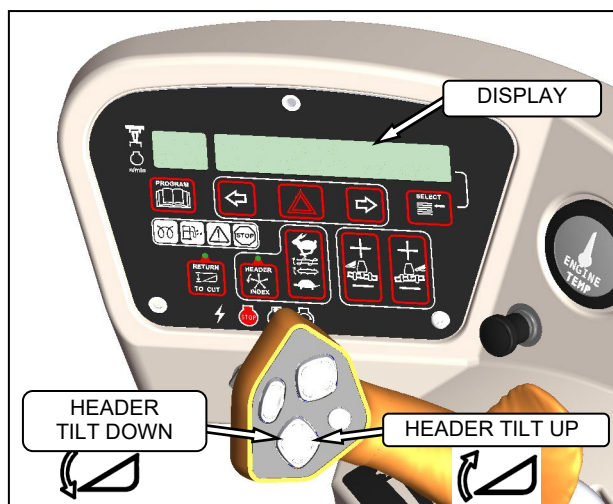

- Using HEADER DOWN switch, lower header fully with lift cylinders fully retracted.

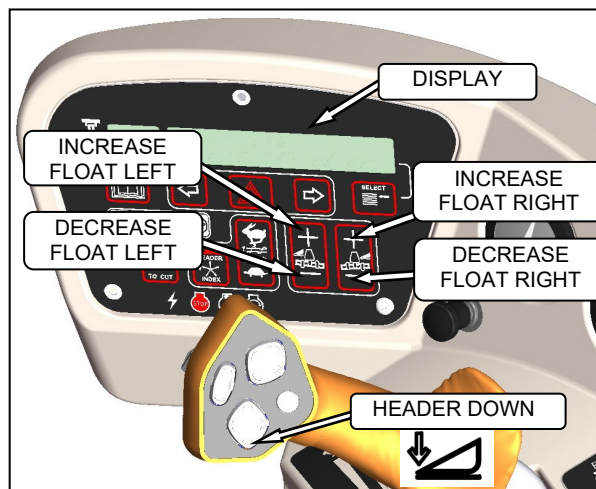

- Using left float switch, push + to increase float, or - to decrease float on left side of header. DISPLAY will indicate selected float for left side, for example (8.0 L FLOAT R XX.X).
- Repeat for right side float with right switch. DISPLAY will indicate float for both sides, for example (8.0 L FLOAT R 3.0).
- Select a second preset with the float preset switch.
- Repeat steps e. and f. to set the float.
- Select a third preset with the float preset switch.
- Repeat steps e. and f. to set the float.
- Operate windrower.

HEADER – GENERAL

6.4.3 LEVELLING

The windrower linkages are factory set to provide the proper level for the header and should not normally require adjustment. If the header is not level, perform the following checks prior to adjusting the leveling linkages. The float springs are not used to level the header.

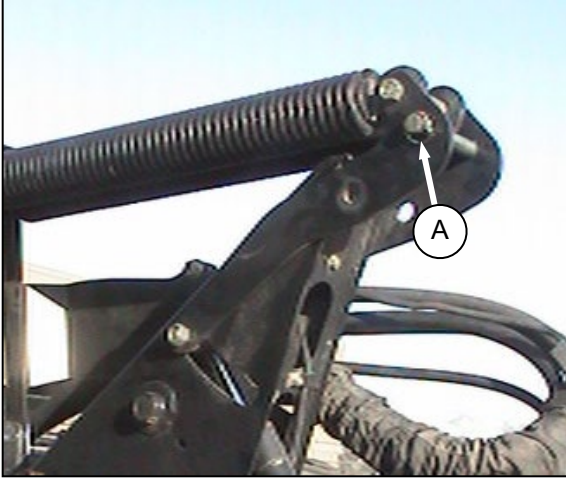

- a. Check windrower tire pressures.
- b. Place float pins in locked out location (A).
- c. Level header as follows:
 1. Park windrower on level ground.
 2. Raise header fully and hold momentarily to allow lift cylinders to re-phase.

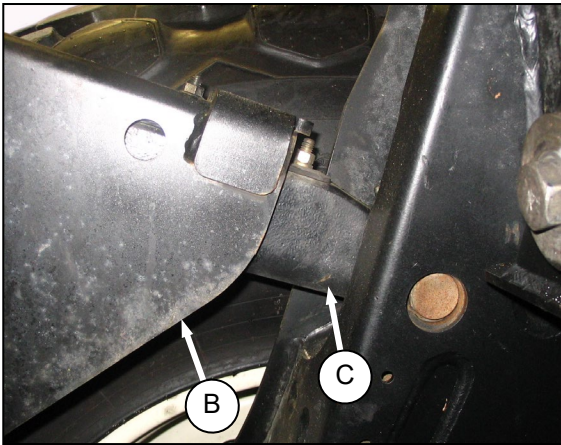

3. Set header approximately 6 inches (150 mm) off ground and check that member (B) is against link (C). Note high and low end of header.
4. Place wooden blocks under header cutterbar and legs, and lower header onto blocks so that members (B) lift off links (C). Stop engine.



DANGER

Stop engine and remove key from ignition before leaving operator's seat for any reason. A child or even a pet could engage an idling machine.

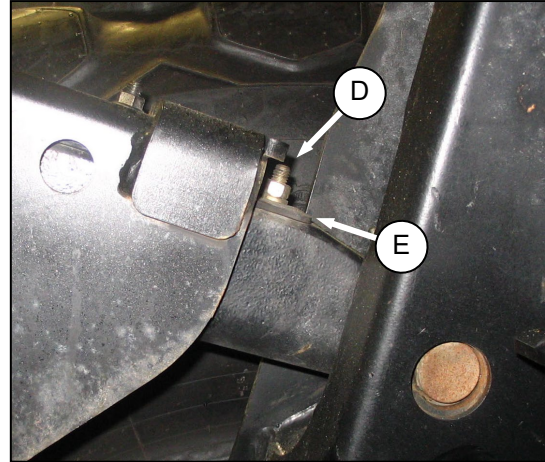

5. On high side, remove nut, washer and bolt (D) that attaches shims (E) to link.
6. Remove one or both shims (E) and reinstall the hardware (D).
- d. Start engine and raise header slightly. Check level of header.
- e. If additional levelling is required, install the

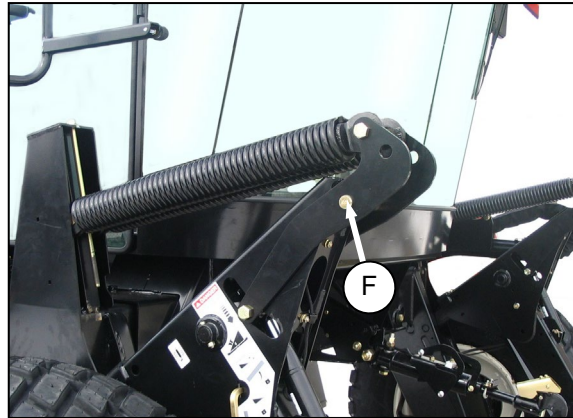

- removed shim on the opposite linkage.
- f. Once header is level, return float pins to their engaged position (F).

NOTE

If required, additional shims are available from your dealer

NOTE

Float does not require adjustment after levelling header.

HEADER – GENERAL

6.4.4 HEADER DRIVE

The headers are hydraulically driven and controlled from the windrower with no mechanical drive shafts.

One hydraulic piston pump provides fluid power to the rotary disc header, or to auger and draper header knife and reel drives.

One of three gear pumps drives the draper or auger, the second gear pump operates the Double Windrow Attachment, and the third gear pump provides flow for header lift, tilt, and float.



CAUTION

Check to be sure all bystanders have cleared the area.

- a. Engage the header as follows:



1. Move throttle to (A) adjust engine speed to idle.
2. Push center and pull header drive switch to engage header drive. A slight delay between switch on and operating speed is normal.
3. Push switch to disengage header drive.

- b. Reverse the header operation as follows:

NOTE

The optional hydraulic reversing kit must be installed for auger and draper with conditioner equipped windrowers. It is standard for rotary disc headers.

- Reverses knife and conditioner on D Series draper headers.
- Reverses reel, auger, knife and conditioner on A Series auger headers.
- Reverses the entire header drive.

NOTE

To re-engage header drive, push down and pull up header drive knob.

1. Disengage header.

IMPORTANT

Always move throttle lever back to idle before engaging header drive. Do not engage header with engine at full RPM.



2. Push down and hold header drive reverse button and pull up the header drive switch.
3. CDM will display HEADER REVERSE.
4. Release reverse button to stop header.
5. Push down the header drive switch to off so that it can be restarted.

HEADER – GENERAL

6.4.5 HEADER ANGLE

Header angle is defined as the angle between the ground and the drapers/cutterbar and is adjustable to accommodate crop conditions and/or soil type.

Refer to the appropriate header operator's manual for range of adjustment and recommended settings for your particular header.

The header angle can be hydraulically adjusted from the cab without shutting down the windrower. A readout on the CDM allows the operator to establish settings for each crop condition.

IMPORTANT

Changing header angle will affect flotation slightly because it has the effect of making the header lighter or heavier.

IMPORTANT

To prevent excessive guard breakage when conditions are not suited to heavier float (e.g. rocky or wet), do not use the tilt control on the go. Instead, use the header height switch.

Change header angle as follows:

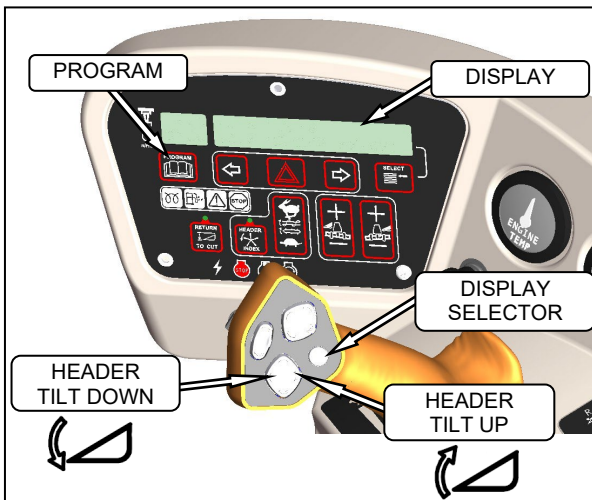

- a. To decrease (flatten) header angle, operate HEADER TILT UP switch on GSL handle so that cylinder (A) retracts. The CDM display will show a reading on the lower line of decreasing value between 00.0 and 10.0.

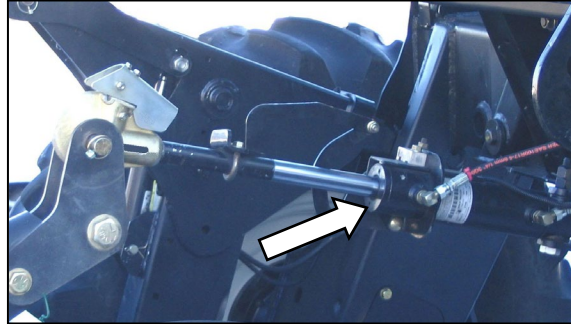

- b. To increase (steepen) header angle, operate HEADER TILT DOWN switch on GSL handle so that cylinder extends. The CDM display will show a reading on the lower line of increasing value between 00.0 and 10.0.
- c. The header tilt switch can be deactivated to prevent inadvertent header angle changes when pressing the header height control switches. Refer to paragraph 5.17.5 Cab Display Module Programming
 1. Switch to PROGRAM mode on CDM.
 2. Press SELECT until SET CONTROL LOCKS? is displayed.
 3. Press \Rightarrow to display HEADER TILT.
 4. Press \Rightarrow to LOCK (deactivate) the control.
 5. Press PROGRAM to exit.
- d. Periodically check the operation of the hook locking mechanism and ensure that it is working properly as follows:

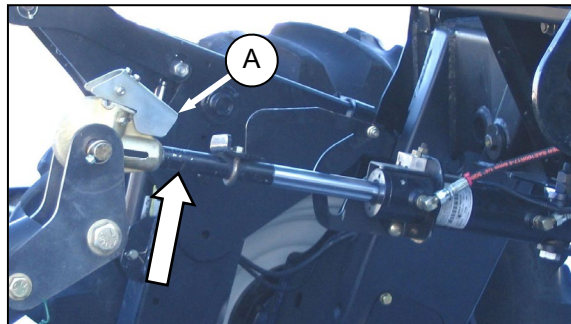

1. If header is attached to windrower, disconnect center link hook from header by pulling up on handle (A) to release the locking device and then lifting the hook off the header pin.

(continued next page)

HEADER – GENERAL

2. Lower the handle into the lock position.

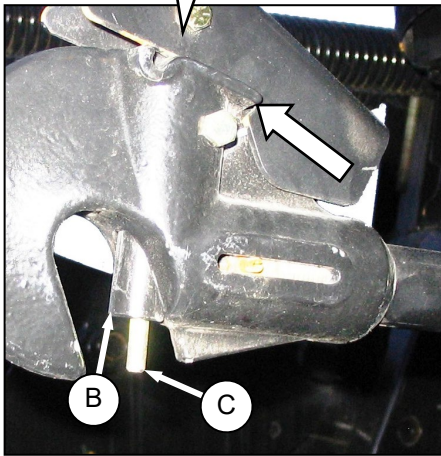
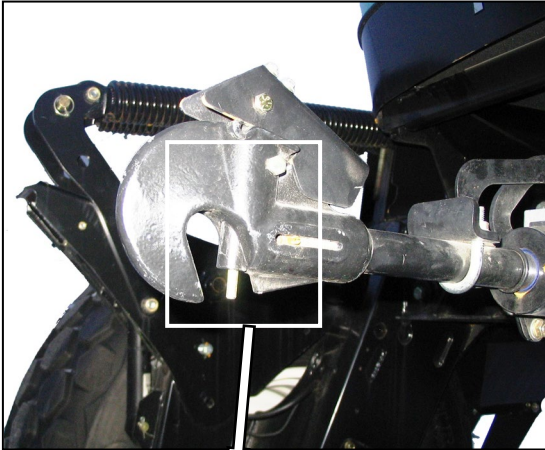

3. Push up on pin (B) only. Handle should catch on casting and pin should not lift.



4. Push up on actuator rod (C) and pin should lift with the handle.

HEADER – GENERAL

6.4.6 CUTTING HEIGHT

The header is raised or lowered with the HEADER UP or HEADER DOWN switches on the GSL. See illustration. The CDM indicates the header height by a reading on the DISPLAY lower line between 00.0 and 10.0, with 00.0 being on the ground. Use DISPLAY SELECTOR switch to display the current setting.

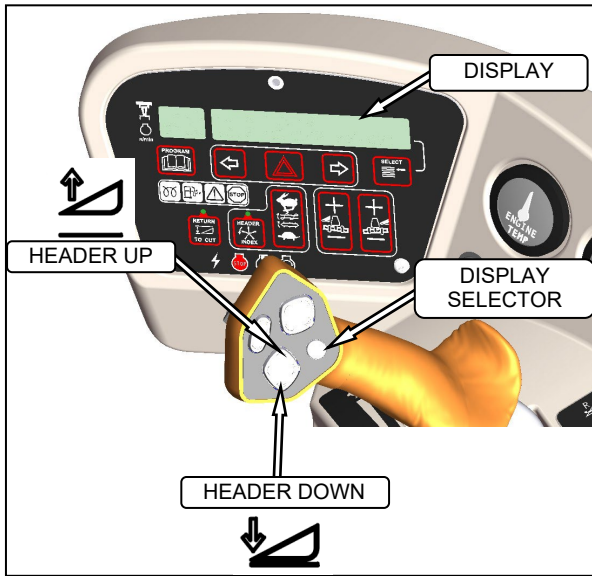

6.4.6.1 Return to Cut

The M Series monitoring system will assist the operator in maintaining the desired cutting height with the RETURN TO CUT feature that can be turned off or on with a switch on the CDM.

The RETURN TO CUT feature enables the operator to have the header return to a pre-selected cutting height and angle. If desired, the CDM can be programmed so that only the cutting height feature is active. The unit is pre-programmed to activate both cutting height and header angle.

The AUTO RAISE HEIGHT feature allows the operator to raise the header to a pre-selected height while in the RETURN TO CUT mode. See Section 6.4.6.2 Auto-Raise Height.

- a. Program the RETURN TO CUT feature as follows:

IMPORTANT

The windrower must be running with the header engaged.

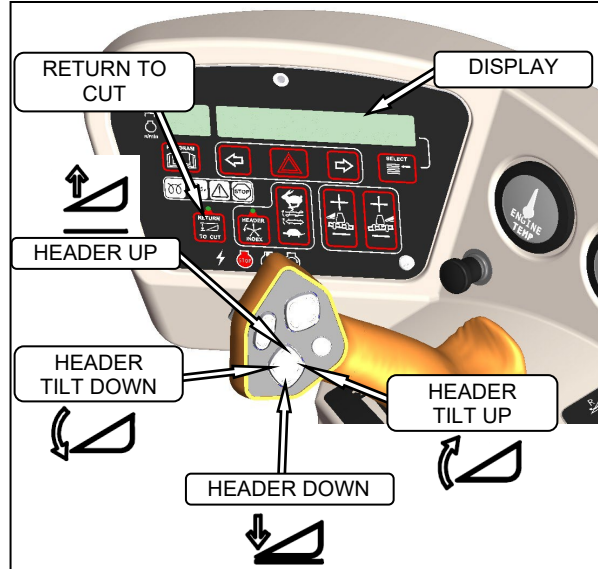

1. RETURN TO CUT switch must be off (indicator light is off).
 2. Adjust the header to the desired cutting height with the HEADER UP or HEADER DOWN switches on the GSL. CDM displays between **00.0 and 10.0**.
 3. Adjust the header angle with the HEADER TILT UP or HEADER TILT DOWN switches on the GSL. CDM displays between **.0 and 10.0**. This step is not required if height only has been pre-selected.
 4. Press the RETURN TO CUT switch on the CDM. The indicator light will illuminate and the settings are now programmed into the WCM.
- b. Use the RETURN TO CUT feature as follows:

IMPORTANT

Ensure the header is engaged and the RETURN TO CUT switch is illuminated.

NOTE

The header can be raised or lowered at any time by **depressing and holding** the HEADER UP or HEADER DOWN switches on the GSL.

1. If header is above the pre-set cutting height, **momentarily press** HEADER DOWN switch and header will return to pre-set height.

(continued next page)

HEADER – GENERAL

- If the header is below the pre-set height, **press and hold** the HEADER UP switch to raise the header. Release switch to stop header. Alarm will sound when header rises past the pre-set height.
- If the header angle is changed, double click (two clicks within 0.5 seconds) the HEADER TILT UP or HEADER TILT DOWN switch and the header will return to the pre-set angle.

NOTE

If the header cannot return to the pre-set height or angle within 30 seconds, the RETURN TO CUT feature will deactivate to prevent the hydraulic oil from overheating. Push the RETURN TO CUT switch to reactivate.

6.4.6.2 Auto-Raise Height

- Program the AUTO RAISE HEIGHT feature as follows:
 - RETURN TO CUT switch can be off or on.
 - Press PROGRAM and SELECT on CDM to enter programming mode.

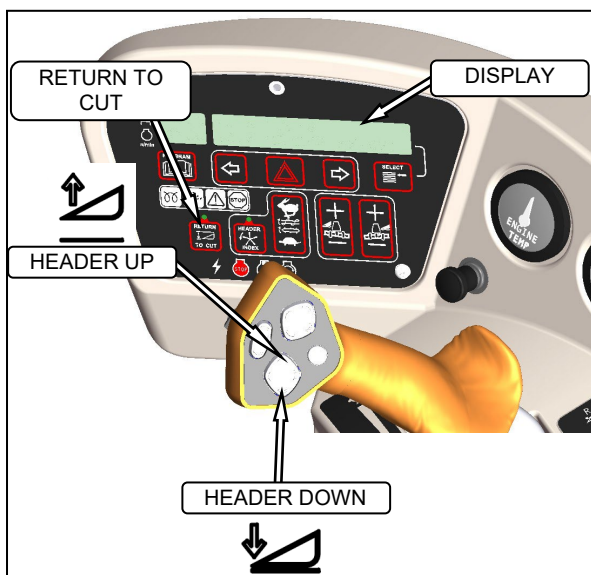

- Press SELECT. TRACTOR SETUP? is displayed on upper line.
- Press \rightarrow , then SELECT. SET KNIFE SPEED? is displayed.
- Press SELECT until AUTO RAISE HEIGHT is displayed.

- Press \leftarrow or \rightarrow to change value on lower line. Range is 4.0 to 10.0 where 10.0 is fully raised.
 - Press PROGRAM to exit programming mode when finished entering desired values.
- b. Use the AUTO RAISE HEIGHT feature as follows:

IMPORTANT

The windrower must be running with the header engaged at the cutting height and the RETURN TO CUT switch activated.

- Double click HEADER UP switch on the GSL to raise the header to the AUTO RAISE HEIGHT set point.

NOTE

If HEADER UP is pressed while header is being raised, AUTO RAISE HEIGHT is temporarily disabled and header will maintain current height.

NOTE

With AUTO RAISE HEIGHT off, the ACRE counter will be disabled when header height value is >9.5. OFF is displayed on the CDM.

- Momentarily press the HEADER DOWN switch on the GSL to return the header to the pre-set cutting height.

6.4.6.3 Header Drop Rate

The header should lower gradually when the HEADER DOWN switch is pressed. From full height to ground should take approximately 3.5 seconds. If the drop rate requires adjustment, refer to Section 7.11.5.3 Header Drop Rate, in MAINTENANCE/SERVICE.

HEADER – GENERAL

6.4.7 DOUBLE WINDROWING

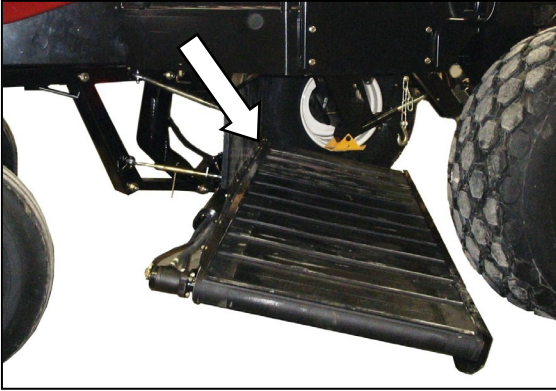

The double windrow attachment (DWA) allows the combining of two windrows of conditioned material close together to be picked up by a forage chopper.

The system is for use with the A Series auger header, R Series rotary disc header, and D60 draper header with HC10 hay conditioner.

The conditioned crop is deposited onto the side delivery system draper and delivered to the side of the windrower when required. Raising the side delivery system shuts off the draper and allows the crop to be deposited between the windrower wheels as it would be without the side delivery system.

Refer to MacDon M Series Windrower Double Windrow Attachment Manual (Form #169216) for complete operating and maintenance instructions. The manual is shipped with the DWA Kit.

6.4.7.1 Deck Position

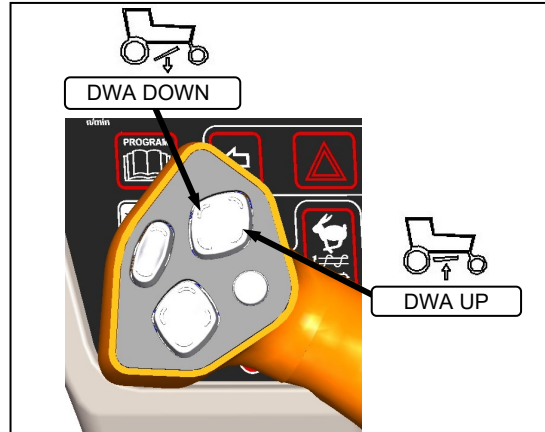

The deck is raised and lowered with the DWA UP and DWA DOWN switches on the GSL, or with the rocker switch on the operator's console, depending on how the windrower CDM is programmed during the installation of the DWA.

6.4.7.2 Draper Speed

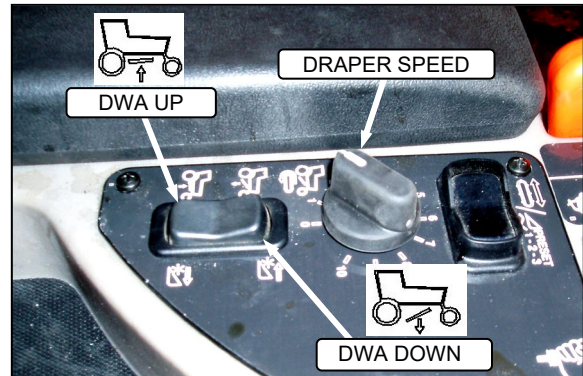

The draper speed is controlled with the rotary switch next to the rocker switch on the operator's console.

HEADER OPERATION – D SERIES

6.5 D SERIES HEADER OPERATION

The M205 must be equipped with a draper drive basic kit and a completion kit as shown.

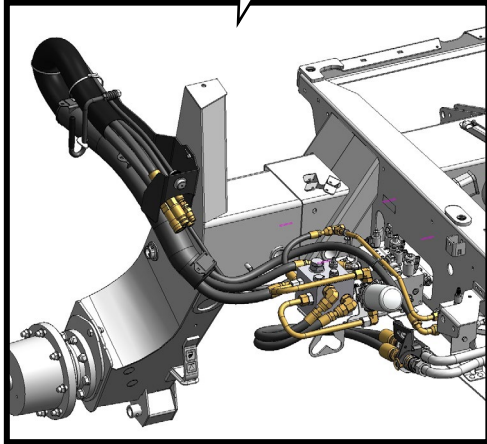

DRAPER HEADER HYDRAULICS

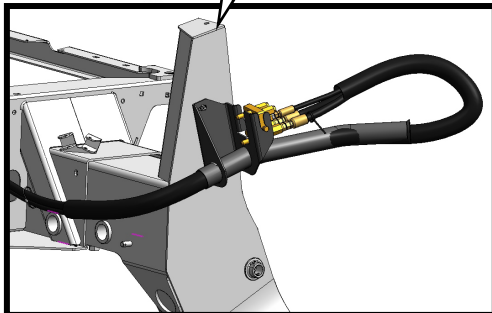

DRAPER HEADER REEL HYDRAULICS

If necessary, obtain the following kits from your MacDon dealer and install them in accordance with the instructions supplied with the kits.

| Kit Description | Kit Number |
|-----------------|------------|
| Base Kit | B5491 |
| Completion | B5496 |
| Coupler | B5497 |

6.5.1 HEADER ATTACHMENT

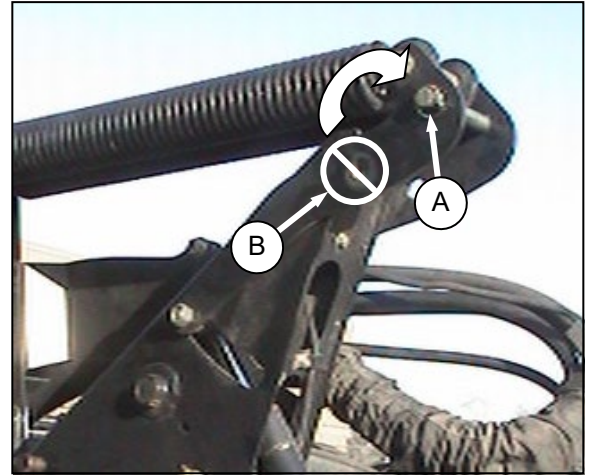

IMPORTANT

To prevent damage to the lift system when lowering header lift linkages without a header or weight box attached to windrower, ensure that float engagement pin is installed in storage location (A), and **not** installed at hole location (B).

- a. If not installed, attach draper header boots (supplied with header) to windrower lift linkage as follows:

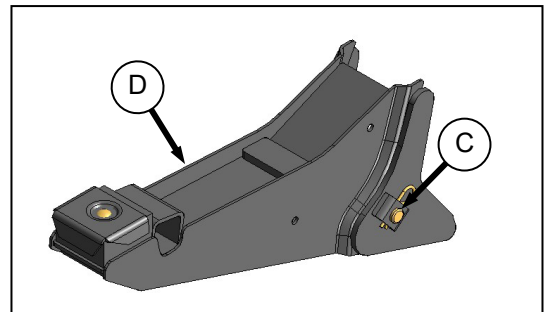

1. Remove pin (C) from boot (D).

(continued next page)

HEADER OPERATION – D SERIES

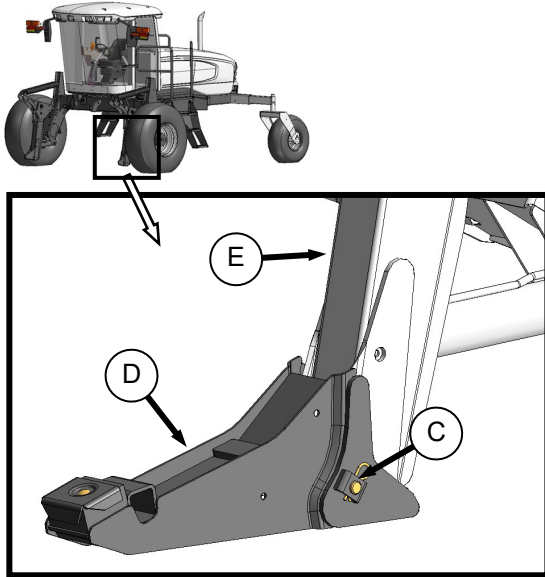

2. Locate boot (D) on lift linkage (E) and reinstall pin (C). Pin may be installed from either side of boot.
3. Secure pin (A) with hairpin.
4. Repeat for opposite side.

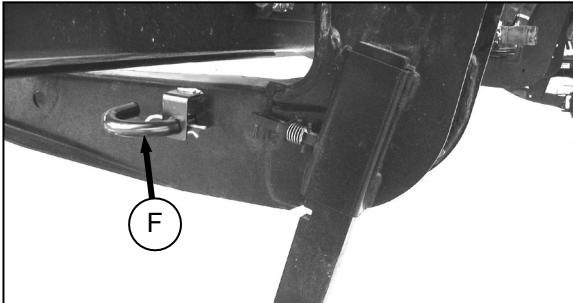

- b. Remove hairpin on pins (F) and remove pins from header legs.



CAUTION

Check to be sure all bystanders have cleared the area.

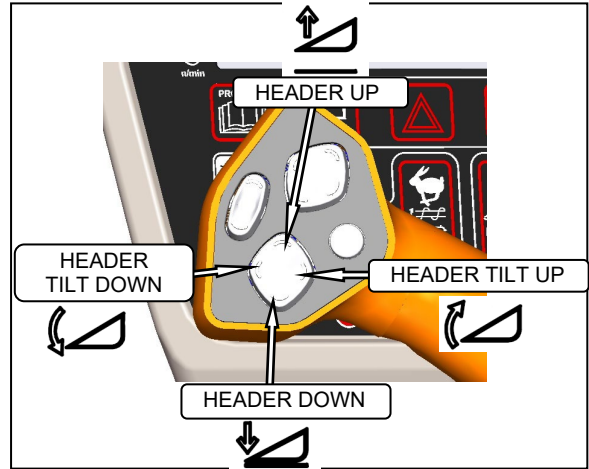

- c. Start the engine and activate HEADER DOWN button on the GSL to fully retract header lift cylinders.

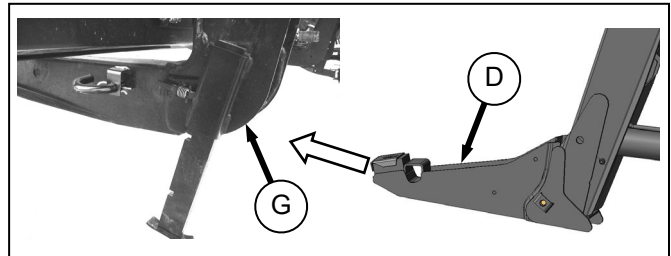

- d. Slowly drive windrower forward so that boots (D) enter header legs (G). Continue to drive slowly forward until lift linkages contact support plates in the header legs, and header nudges forward.
- e. Check that linkages are properly engaged in

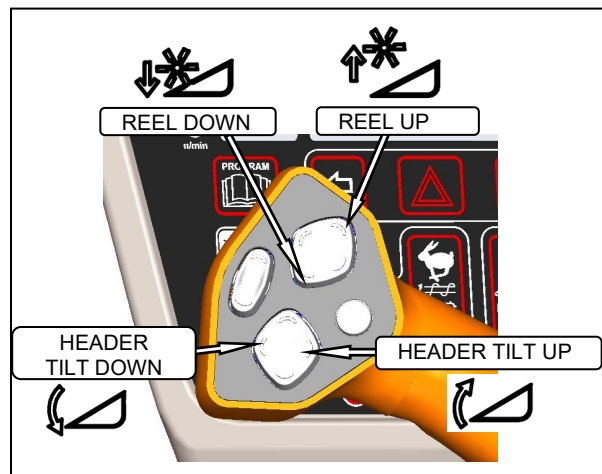

header legs, contacting support plates.

- f. Adjust the position of the center link cylinder with the REEL UP and REEL DOWN switches, and HEADER TILT switches on the GSL to position the hook above the header attachment pin.

HEADER OPERATION – D SERIES

(continued next page)

HEADER OPERATION – D SERIES

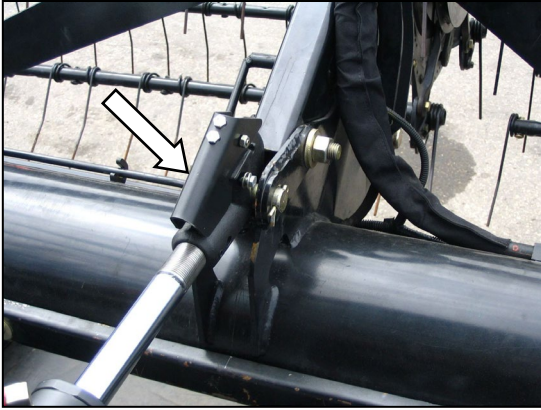

- g. Lower the center link onto the header with REEL DOWN switch until it locks into position (handle is down).
- h. Raise the header fully with the HEADER UP switch on the GSL. Stop engine and remove key.



DANGER

To avoid bodily injury from fall of raised header, always engage header lift cylinder stops when working on or around raised header.

- i. Engage lift cylinder stops on both lift cylinders. Refer to Section 6.4.1 Header Lift Cylinder Stops.

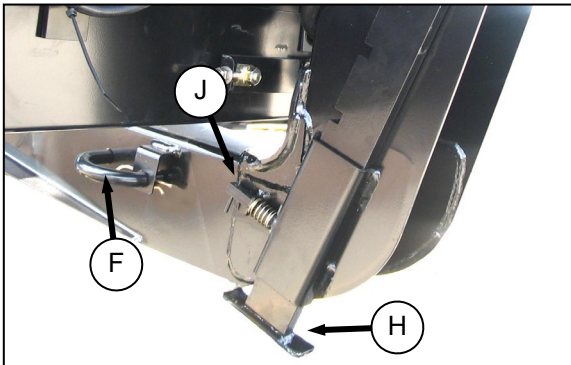

- j. Install pin (F) through header leg, (engaging U-bracket in lift linkage) on both sides and secure with hairpin.
- k. Raise header stand (H) to storage position by pulling pin (J) and lifting stand into uppermost position. Release pin (J).

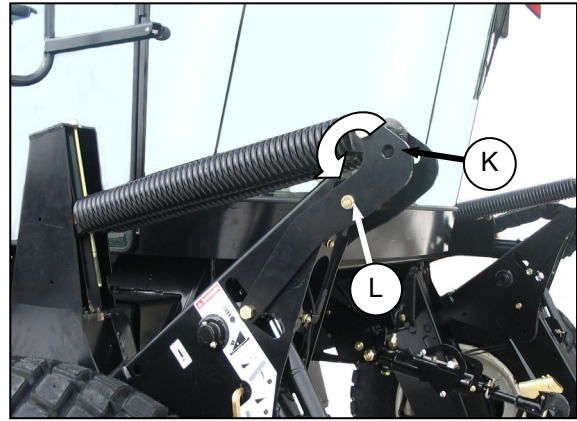

- l. Remove pin from storage position (K) in linkage and insert in hole (L) to engage float springs. Secure with hairpin.
- m. Disengage lift cylinder stops. Refer to Section 6.4.1 HEADER LIFT CYLINDER STOPS.
- n. Start engine and activate header lift cylinders (switch on GSL) to lower header fully.
- o. Stop engine and remove key.

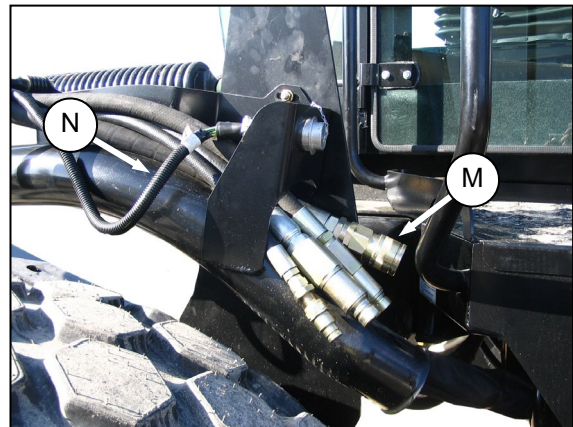

- p. Connect header drive hoses (M) and electrical harness (N) to header. Refer to the Draper Header Operator's Manual.

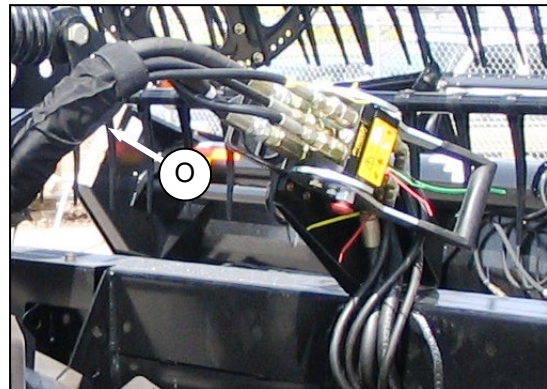

- q. Connect reel hydraulics (O) at RH side of windrower. Refer to the Draper Header Operator's Manual.

HEADER OPERATION – D SERIES

6.5.2 HEADER DETACHMENT

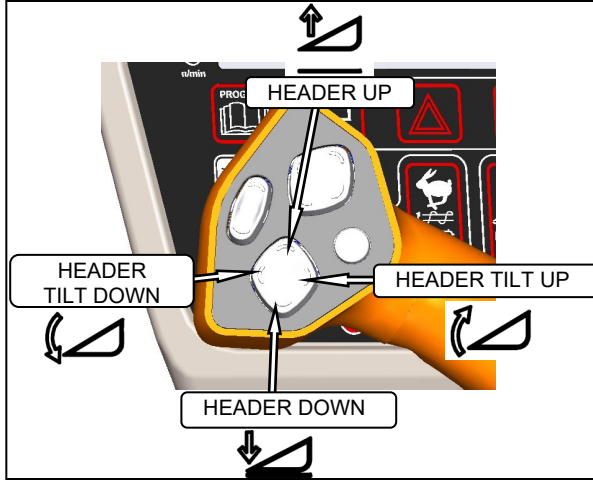

- a. Raise the header fully with the HEADER UP switch on the GSL. Stop engine and remove key.



DANGER

To avoid bodily injury from fall of raised header, always engage header lift cylinder stops when working on or around raised header.

- b. Engage lift cylinder stops on both lift cylinders. Refer to Section 6.4.1 Header Lift Cylinder Stops.

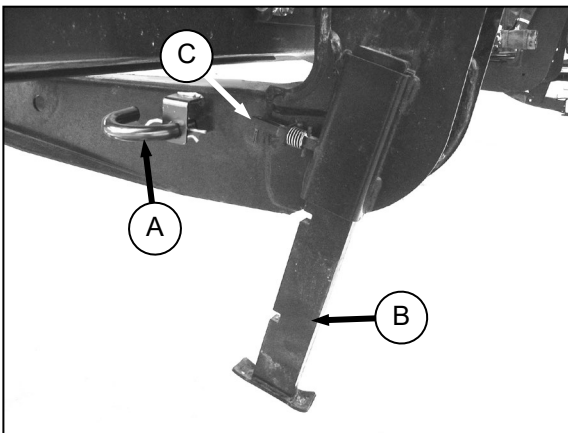

- c. Remove pin (A) from header leg on both sides.
- d. Lower header stand (B) by pulling spring loaded pin (C). Release pin to lock stand.

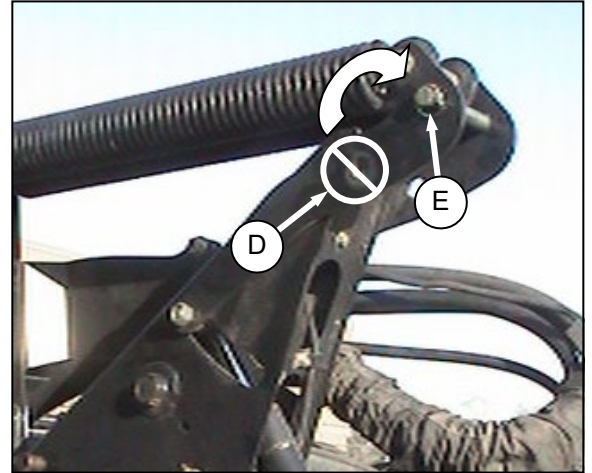

- e. Remove pin from location (D) to disengage float springs, and insert in storage hole (E). Secure with lynch pin.

IMPORTANT

To prevent damage to the lift system when lowering header lift linkages without a header or weight box attached to windrower, ensure that float engagement pin is installed in storage location (E), and **not** installed at hole location (D).

- f. Disengage lift cylinder stops.
- g. Start engine, choose a level area and lower header to the ground. Stop engine and remove key.

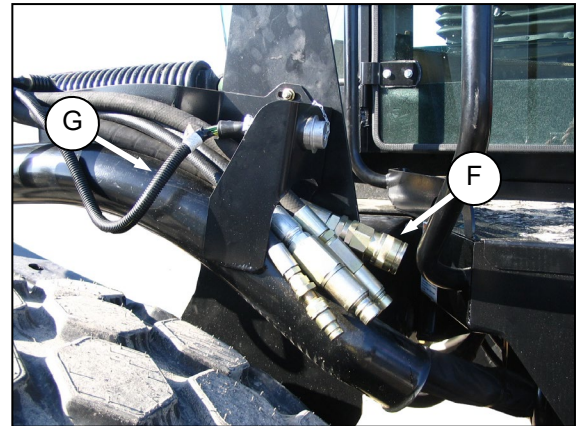

- h. Disconnect header drive hydraulics (F) and electrical harness (G) from header. Refer to the Draper Header Operator's Manual.

(continued next page)

HEADER OPERATION – D SERIES

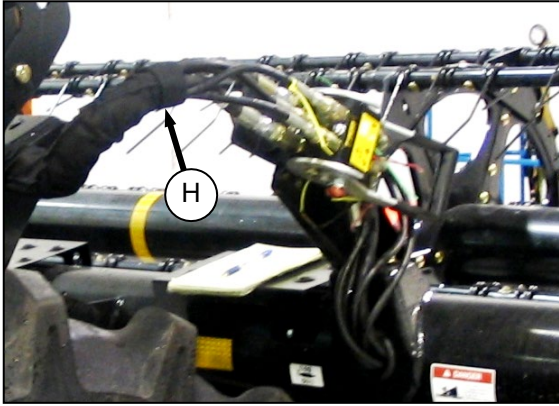

- i. Disconnect reel hydraulics (H) and store on bracket at windrower LH side.

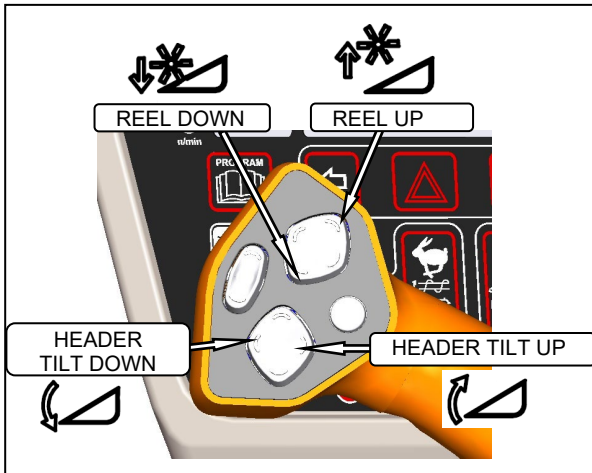

- j. Start engine and activate HEADER TILT cylinder switch on GSL to release load on center link cylinder.

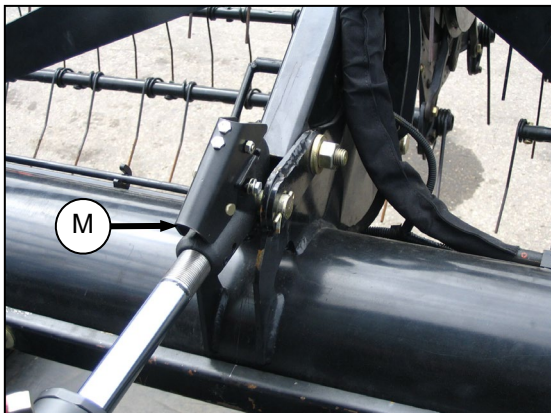

- k. Lift release (M).

- l. Operate the link lift cylinder with REEL UP switch on GSL to disengage the center link from the header.
- m. Slowly back windrower away from header.

NOTE

If hay conditioner is installed, watch clearances on both sides.

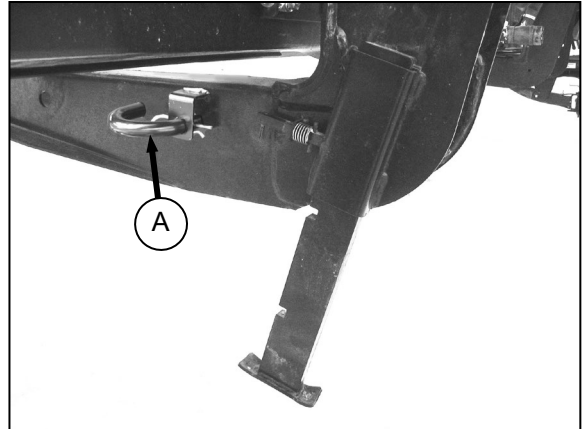

- n. Reinstall pin (A) into header leg and secure with hairpin.

HEADER OPERATION – D SERIES

6.5.3 HEADER POSITION

Refer to Section 6.4 HEADER OPERATION for procedures for controlling header height, header tilt, and float.

IMPORTANT

Under certain conditions, with reel raised to full height, the reel tines may contact the cab roof. Exercise care to avoid damage to the machine.

6.5.4 REEL FORE-AFT POSITION

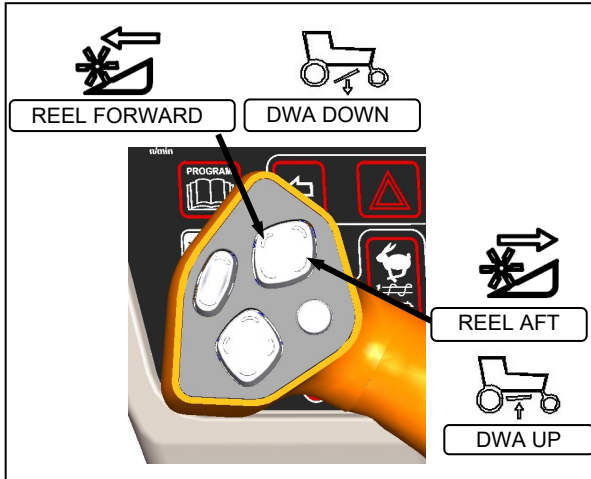

The reel fore-aft position can be hydraulically adjusted with the optional reel position system, and is controlled with multi-function switches on the GSL. Press and hold the switch for the desired fore or aft movement of the reel.

The switches also control adjustments to the optional Double Windrow Attachment (DWA) conveyor and can be activated during programming the CDM.

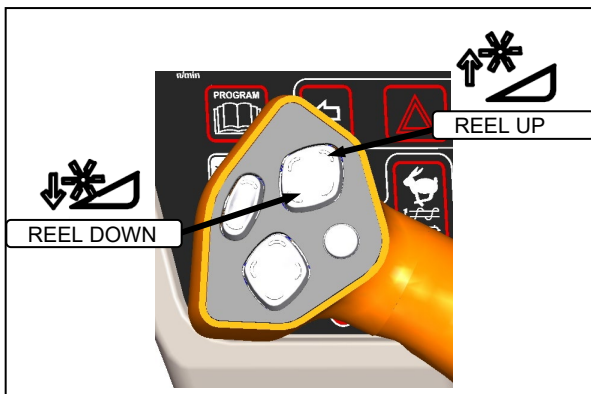

6.5.5 REEL HEIGHT

Press and hold the switch for the desired up or down movement of the reel.

HEADER OPERATION – D SERIES

6.5.6 REEL SPEED

The speed of the reel is controlled with switches on the CDM in the cab. On D Series draper headers, it can be set relative to the ground speed of the windrower using the Header Index feature, or can run independently. Refer to the Operator's Manual for your specific header for windrowing guidelines and recommended speeds.

6.5.6.1 Reel to Ground Speed

Setting the speed of the reel relative to ground speed using the Header Index function allows the operator to run the engine at lower rpm while maintaining the desired ground and reel speed. This mode requires a) setting the Minimum Reel Speed, and b) setting the Reel Index.

NOTE

Reducing engine speed saves fuel and reduces noise in the cab. Ground/cutting speed can be maintained using this feature.

- a. Set **Reel Minimum Speed** as follows

IMPORTANT

Windrower can be moving but must be less than minimum reel speed.



CAUTION

Check to be sure all bystanders have cleared the area.

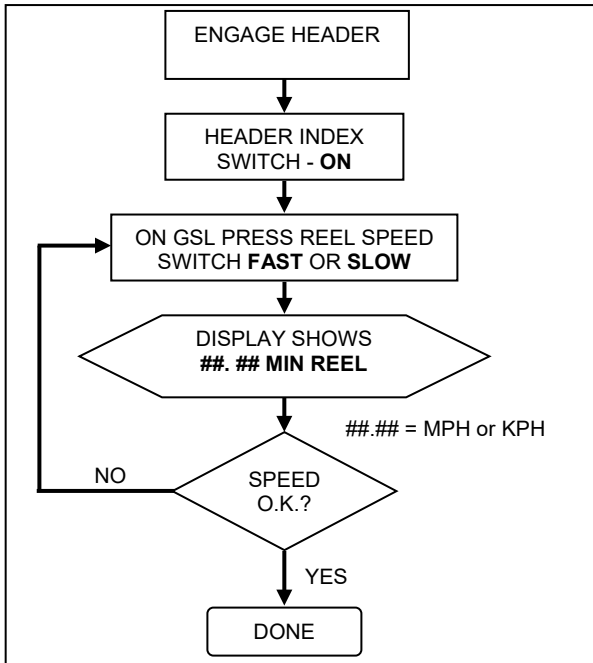

NOTE

DISPLAY will flash ### ## MIN REEL (MPH or KPH) to prompt the operator to change the minimum set point or increase ground speed if Ground Speed Plus Index is less than the Minimum Reel Speed Set Point.

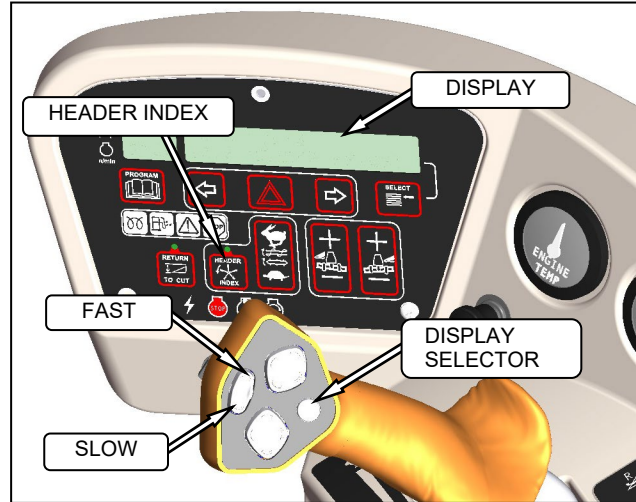

- b. Set **Reel Index** as follows while driving windrower at normal operating speed and greater than minimum reel speed.

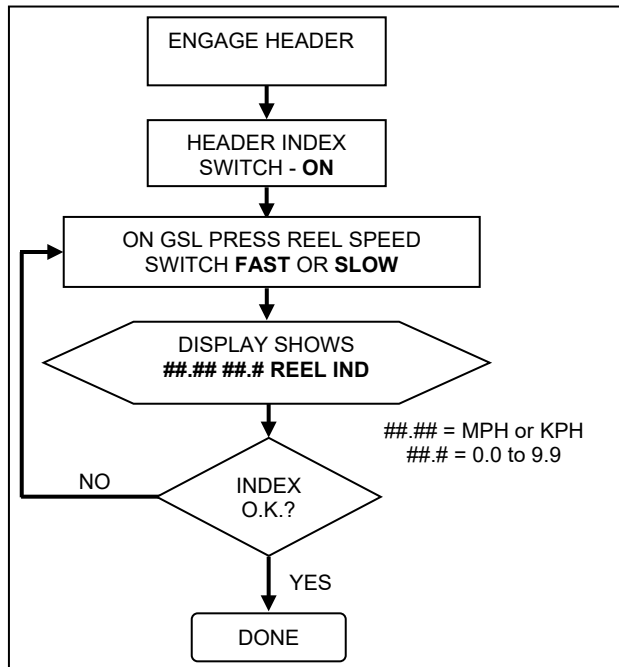

NOTE

See examples on following page.

(continued next page)

HEADER OPERATION – D SERIES

Examples:

Windrower is operating at 8 mph with Header Index on and set at 5.5. Display shows;

13.5 5.5 REEL IND

where **13.5** (8+5.5) is the reel speed in mph, and **5.5** is the header index setting.

Windrower speed drops to 7.5 mph at same Header Index setting. Display shows;

13.0 5.5 REEL IND

where **13.0** (7.5+5.5) is the reel speed in mph, and **5.5** is the header index setting.

Windrower is operating at 8 mph with Header Index on and set at 1.0. Display shows;

9.0 1.0 REEL IND

where **9.0** (8+1.0) is the reel speed in mph, and **1.0** is the header index setting.

6.5.6.2 Reel Only Speed

Set the speed of the reel independently of ground speed as follows:



CAUTION

Check to be sure all bystanders have cleared the area.

NOTE

This procedure can also be used to change the draper speed "on the go". These changes become the new set-points.

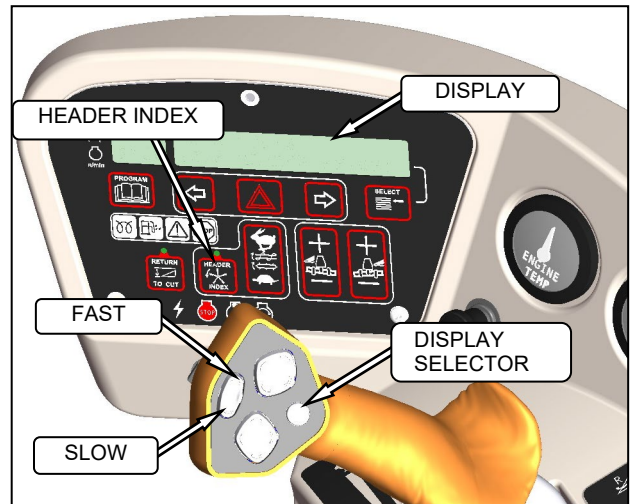
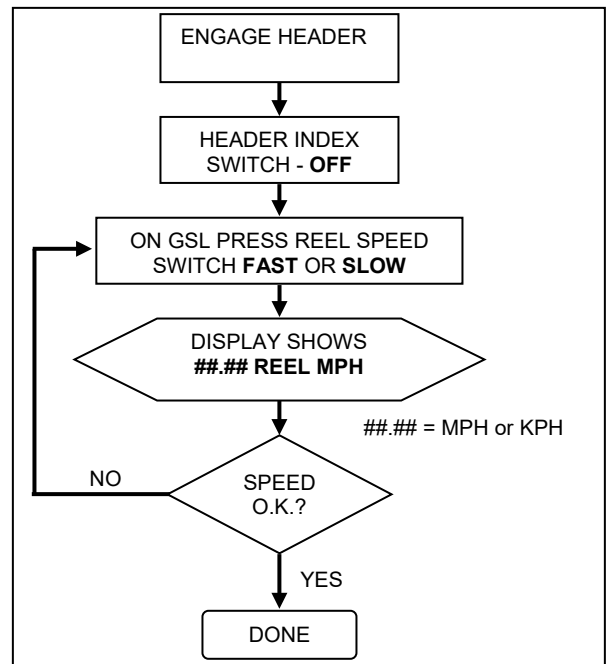

HEADER OPERATION – D SERIES

6.5.7 DRAPER SPEED

Draper speed affects the orientation of stalks in the windrow. Faster draper speeds tend to form herringbone or dovetail configurations. Refer to your header operator's manual for guidelines on what speed to use.

The draper speed can be set with switches on the CDM relative to the ground speed of the windrower with the Header Index function, or can run independently.



CAUTION

Check to be sure all bystanders have cleared the area.

6.5.7.1 Draper To Ground Speed

Setting the speed of the draper relative to ground speed using the Header Index function allows the operator to run the engine at lower rpm while maintaining the desired ground and draper speed. This mode requires a) setting the Minimum Draper Speed, and b) setting the Draper Index.

NOTE

Reducing engine speed saves fuel and reduces noise in the cab. Ground/cutting speed can be maintained using this feature.

- a. Set **Draper Minimum Speed** as follows:

IMPORTANT

Windrower can be moving but must be less than minimum draper speed.

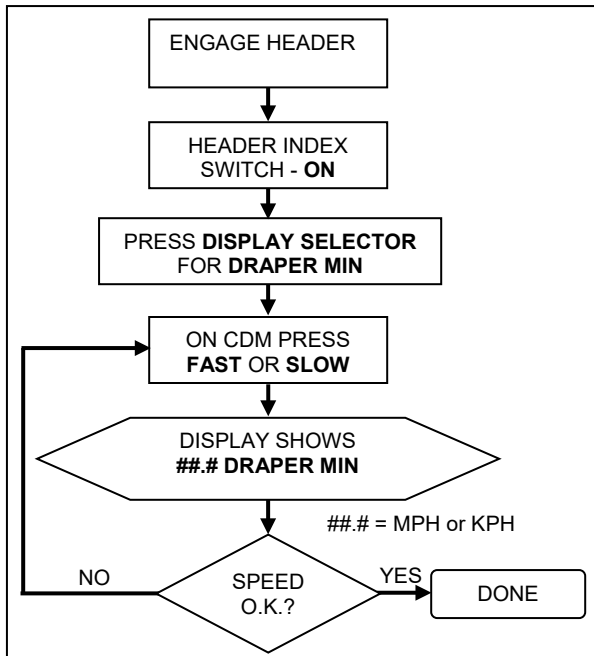

NOTE

DISPLAY will flash ### MIN CONV (MPH or KPH) to prompt the operator to change the minimum set point or increase ground speed if Ground Speed Plus Index is less than the Minimum Draper Speed Set Point.

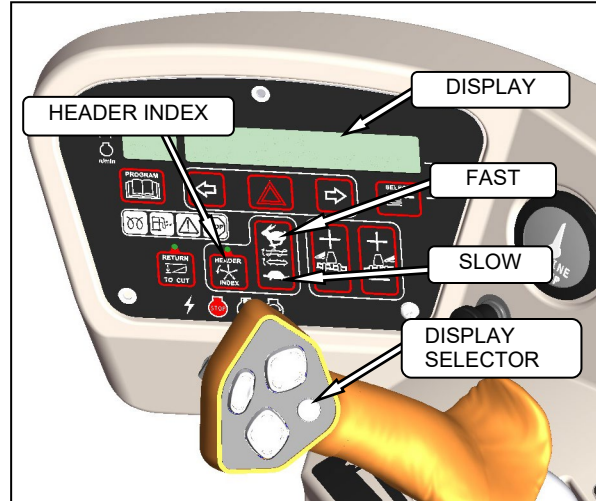

- b. Set **Draper Index** as follows while driving windrower at normal operating speed and greater than minimum draper speed.

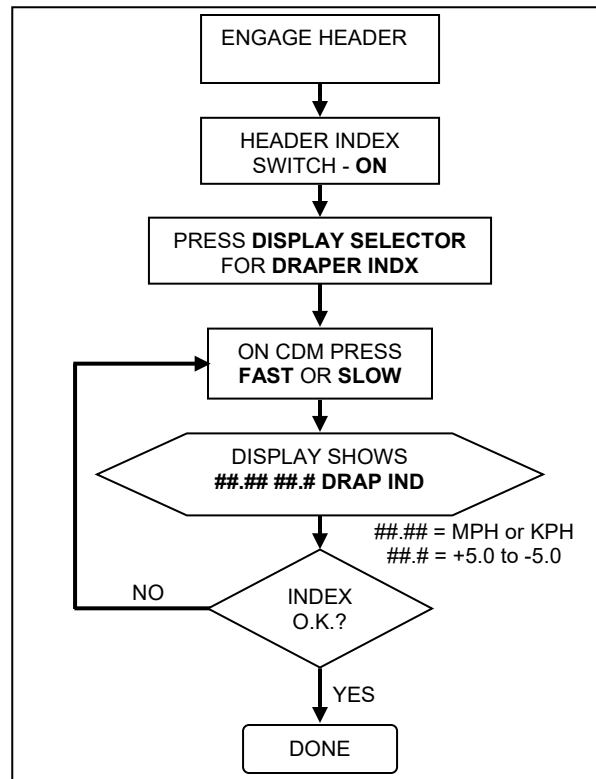

NOTE

See examples on following page.

(continued next page)

HEADER OPERATION – D SERIES

Examples:

Windrower is operating at 8 mph with Header Index on and set at 1.5. Display shows;

9.5 1.5 DRAP INDX

where **9.5** (8+1.5) is the draper speed in mph, and **1.5** is the header index setting.

Windrower speed drops to 7.5 mph at same Header Index setting. Display shows;

9.0 1.5 DRAP INDX

where **9.0** (7.5+1.5) is the draper speed in mph, and **1.5** is the header index setting.

Windrower is operating at 8 mph with Header Index on and set at 0.9. Display shows;

8.9 0.9 DRAP INDX

where **8.9** (8+0.9) is the draper speed in mph, and **0.9** is the header index setting.

6.5.7.2 Draper Speed Independent of Ground Speed

Set the speed of the draper independently of ground speed as follows:

NOTE

This procedure can also be used to change the draper speed "on the go".



CAUTION

Check to be sure all bystanders have cleared the area.

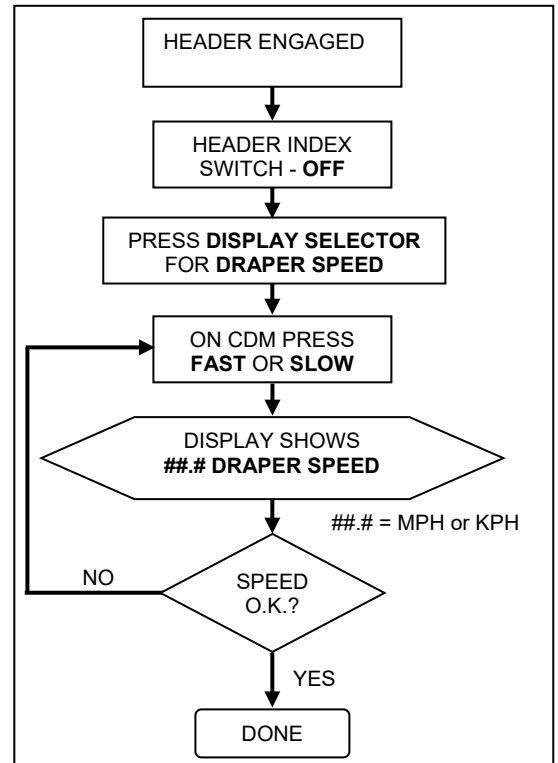

HEADER OPERATION – D SERIES

6.5.8 KNIFE SPEED

The ideal cutting speed of the knife should be such that a clean cut is achieved. Crop types and conditions usually influence the knife and forward speeds.

The windrower WCM reads a code from the header that determines the knife speed range and the minimum speed when the header is first attached to the windrower. The desired speed can be programmed on the CDM and is stored in the WCM memory so that if the header is detached and then re-attached to the windrower, the knife will operate at the original set-point.

If no header code is detected, the CDM displays NO HEADER and the knife speed reverts to a range from 0-1400 strokes per minute and the operator can then pre-set the speed.

NOTE

The knife speed cannot be programmed outside the range specified for each header.

| HEADER DESCRIPTION | | KNIFE SPEED * (Strokes Per Minute [SPM]) | |
|--------------------|---------|--|---------|
| TYPE | SIZE | MINIMUM | MAXIMUM |
| Draper DK | 15 | 1500** | 1900** |
| Draper DK | 20 & 25 | 1400 | 1700 |
| Draper DK | 30 | 1200 | 1600 |
| Draper DK | 35 | | 1500 |
| Draper DK | 40 | 1100 | 1400 |
| Draper SK | 20 & 25 | 1200 | 1500 |
| Draper SK | 30 | | 1450 |
| Draper SK | 35 | 1100 | 1400 |
| Draper SK | 40 | 1050 | 1300 |

* Suggested Overload Setting – 75% of Knife Speed.
 ** Grass Seed – 1400 to 1950.

Display and set knife speed on-the-go as follows:



CAUTION

Check to be sure all bystanders have cleared the area.

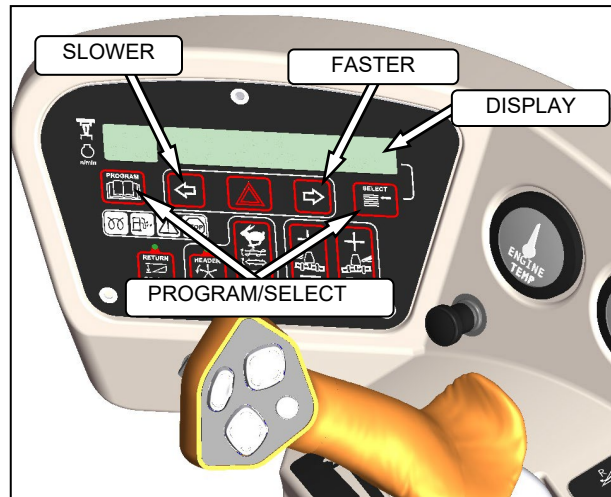
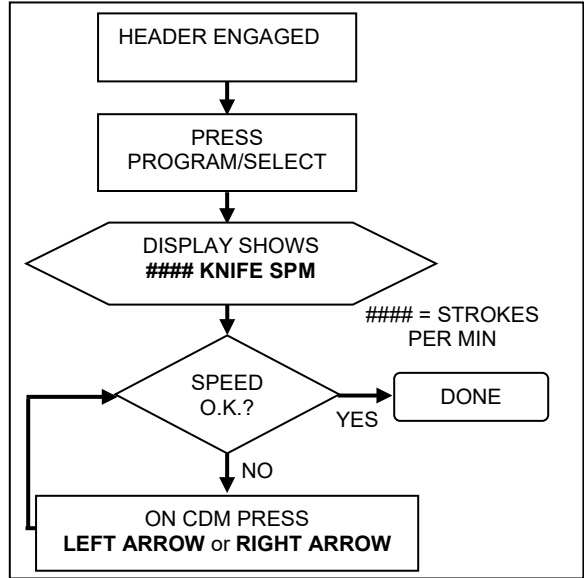

HEADER OPERATION – D SERIES

6.5.9 DECK SHIFT (OPTIONAL)

The hydraulic deck shift option allows the operator to control deck position and draper rotation from the operator's station. It enables crop delivery from left side, center, or right side of the header. Shift decks as follows:



CAUTION

Check to be sure all bystanders have cleared the area.

- a. Engage header.

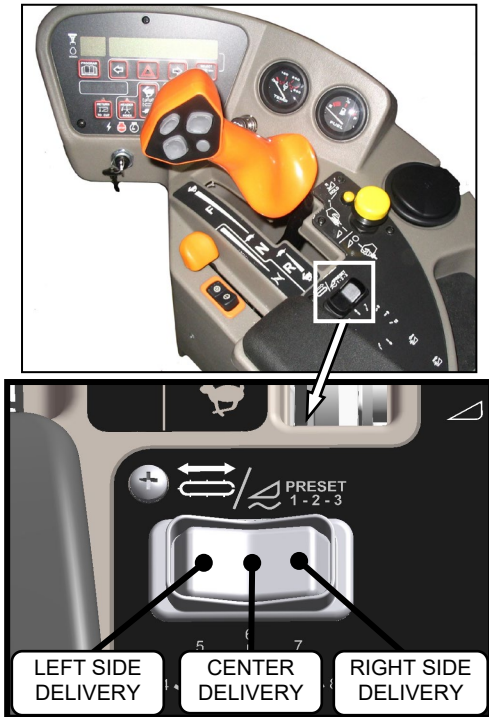

- b. Push switch to desired delivery position. Deck(s) will move, and direction of drapers will change accordingly.
- c. Operate windrower.

6.5.9.1 Float Options With Deck Shift

For draper headers equipped with the deck shift option, the header float can be set for each position of the decks. The float is then maintained when the decks are shifted. Program the float as follows:



CAUTION

Check to be sure all bystanders have cleared the area.

- a. Engage header.

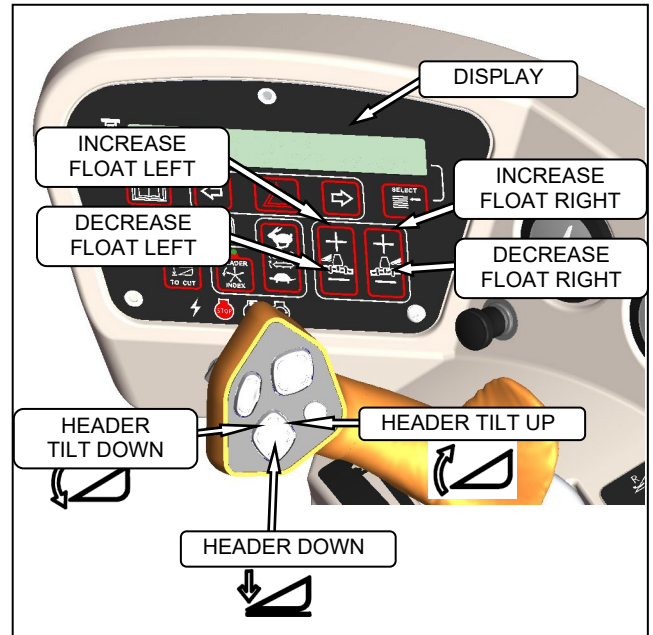

- b. Using HEADER TILT SWITCHES, set center link to mid-range position (05.0 on DISPLAY).
- c. Push deck shift switch to desired delivery position. See opposite.
- d. Using HEADER DOWN switch, lower header fully with lift cylinders fully retracted.
- e. Using left float switch, push + to increase float, or - to decrease float on left side of header. DISPLAY will indicate selected float for left side, for example (8.0 L FLOAT R XX.X).
- f. Repeat for right side float with right switch. DISPLAY will indicate float for both sides, for example (8.0 L FLOAT R 3.0).
- g. Select a second deck position with the deck shift switch.
- h. Repeat steps e. and f. to set the float.
- i. Select a third position if desired with the deck shift switch.
- j. Repeat steps e. and f. to set the float.

HEADER OPERATION – A SERIES

6.6 A SERIES HEADER OPERATION

The M205 must be equipped with an auger drive basic kit and a completion kit as shown.

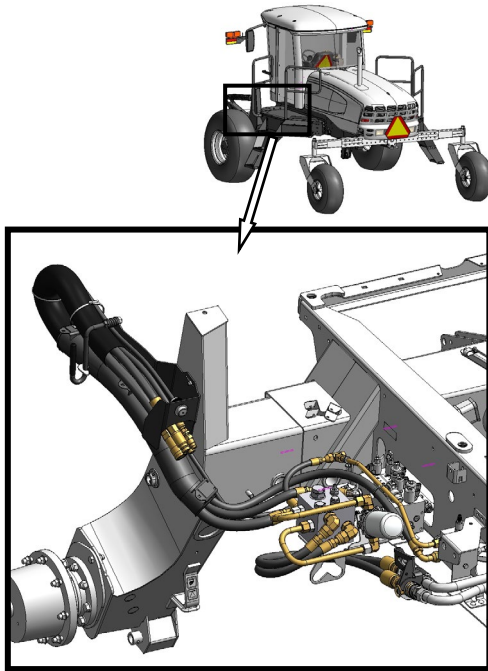

AUGER HEADER HYDRAULICS

If necessary, obtain the following kits from your MacDon dealer and install them in accordance with the instructions supplied with the kits.

| Kit Description | Kit Number |
|-----------------|------------|
| Base Kit | B5491 |
| Completion | B5492 |
| Coupler | B5497 |

6.6.1 HEADER ATTACHMENT

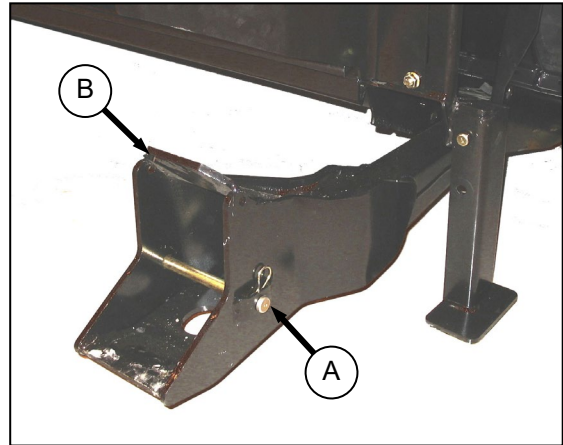

- a. Remove hairpin from pin (A), and remove pin

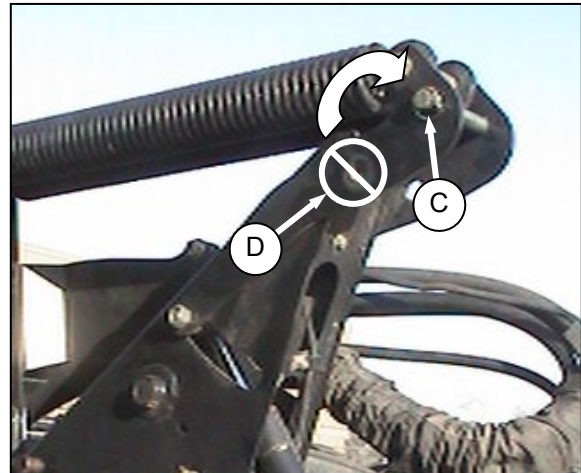

from left and right header boots (B) on header.

IMPORTANT

To prevent damage to the lift system when lowering header lift linkages without a header or weight box attached to windrower, ensure that float engagement pin is installed in storage location (C), and **not** installed at hole location (D).

(continued next page)

HEADER OPERATION – A SERIES



CAUTION

Check to be sure all bystanders have cleared the area.

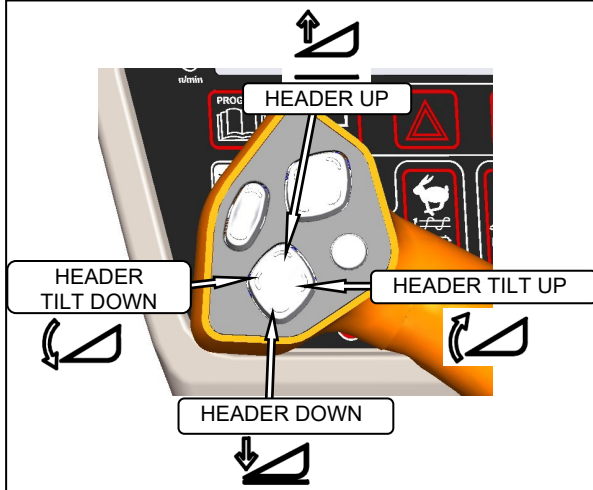

- b. Start the engine and activate HEADER DOWN button on the GSL to fully retract header lift cylinders.

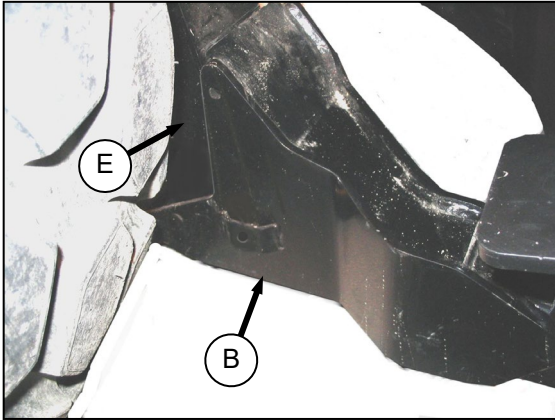

- c. Slowly drive windrower forward so that feet (E) on windrower enter boots (B) on the header. Continue to drive slowly forward until feet engage the boots, and header nudges forward.

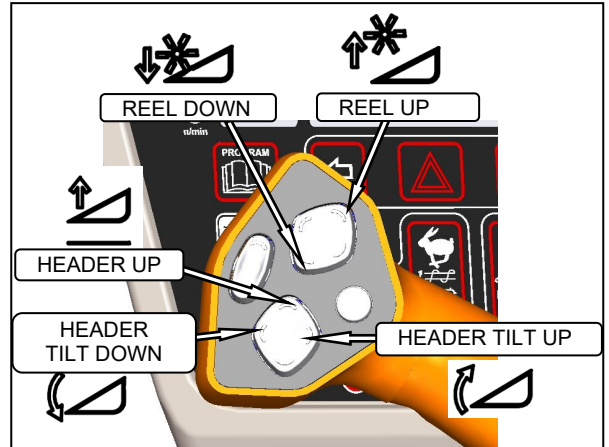

- d. Adjust the position of the center link cylinder with the REEL UP and REEL DOWN switches, and HEADER TILT switches on the GSL to position the hook above the header attachment pin.

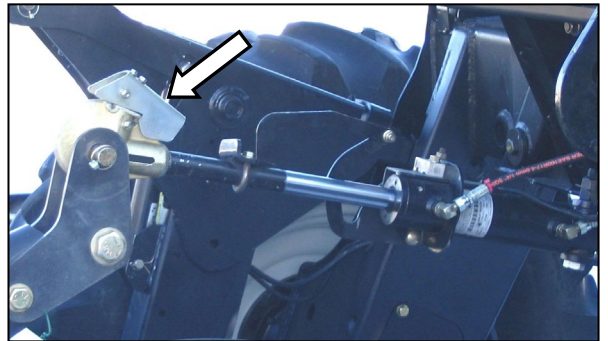

- e. Lower the center link onto the header with REEL DOWN switch until it locks into position (handle is down).
f. Raise the header fully with the HEADER UP switch on the GSL. Stop engine and remove key.



DANGER

To avoid bodily injury from fall of raised header, always engage header lift cylinder stops when working on or around raised header.

- g. Engage lift cylinder stops on both lift cylinders. Refer to Section 6.4.1 Header Lift Cylinder Stops.

(continued next page)

HEADER OPERATION – A SERIES

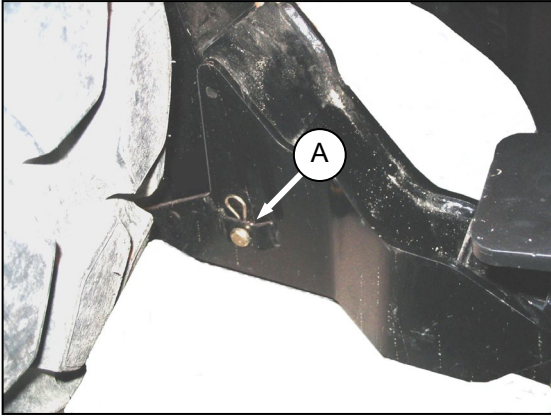

- h. Install pin (A) through each boot and foot and secure with hairpin..

IMPORTANT

Ensure pin (A) is fully inserted and hairpin is installed behind bracket.

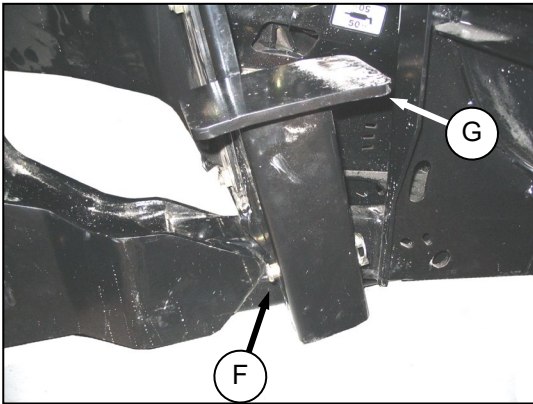

- i. Remove lynch pin from pin (F) in stand (G).
- j. Hold stand and remove pin (J).
- k. Reposition stand to storage position by inverting stand and re-locating on bracket as shown. Reinsert pin (F) and secure with lynch pin.

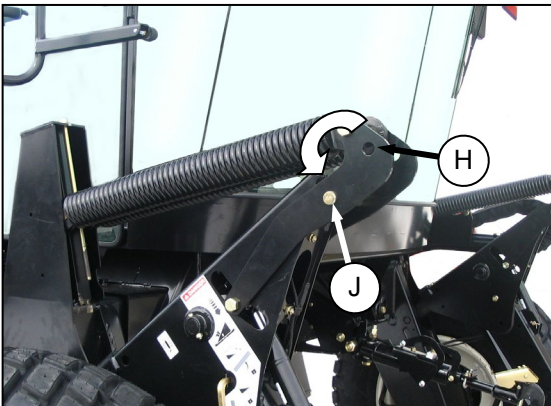

- l. Remove pin (H) from storage position in linkage and insert in hole (J) to engage float springs. Secure with lynch pin.

- m. Disengage lift cylinder stops.
- n. Start engine, and activate HEADER DOWN switch on GSL to lower header fully. Stop engine and remove key.

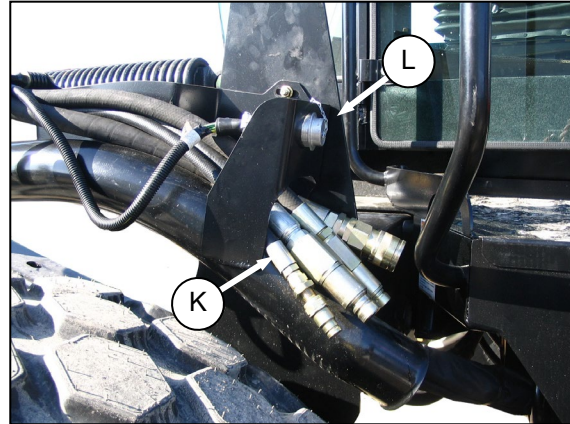

- o. Connect header drive hydraulics (K) and electrical harness (L) to header. Refer to Auger Header Operator's Manual.

HEADER OPERATION – A SERIES

6.6.2 HEADER DETACHMENT

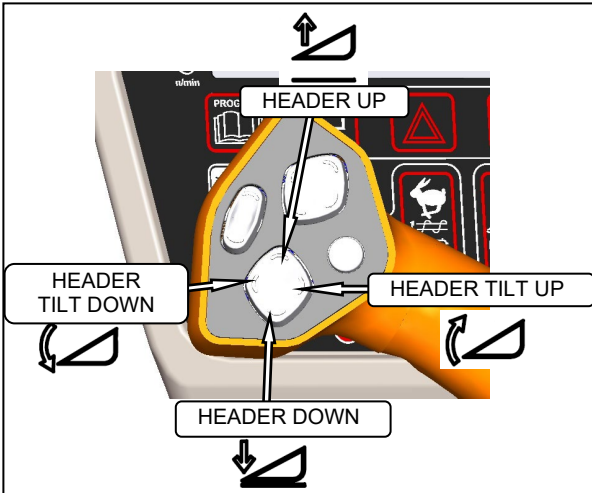

- a. Raise the header fully with the **HEADER UP** switch on the GSL. Stop engine and remove key.



DANGER

To avoid bodily injury from fall of raised header, always engage header lift cylinder stops when working on or around raised header.

- b. Engage lift cylinder stops on both lift cylinders. Refer to Section 6.4.1 Header Lift Cylinder Stops.

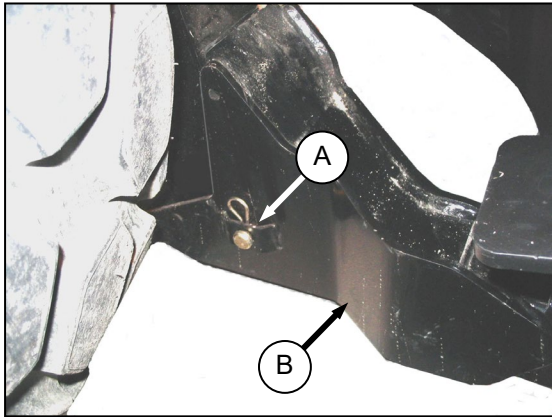

- c. Remove hairpin from pin (A), and remove pin from left and right header boots (B) on header.

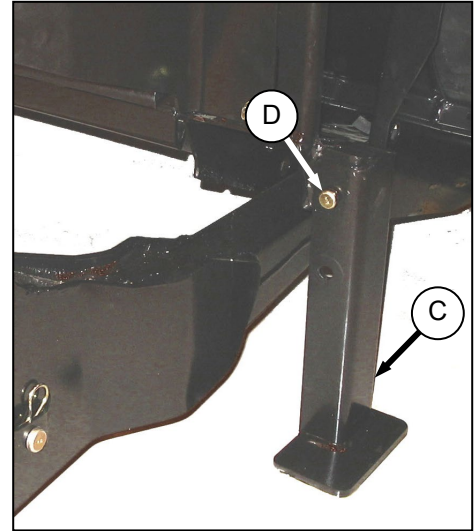

- d. Lower stand (C) by pulling pin (D), inverting stand and re-locating on bracket. Reinsert pin (D) and secure with hairpin.
- e. Remove pin from linkage (E) to disengage float springs, and insert in storage hole (F). Secure with lynch pin. Repeat for opposite linkage.

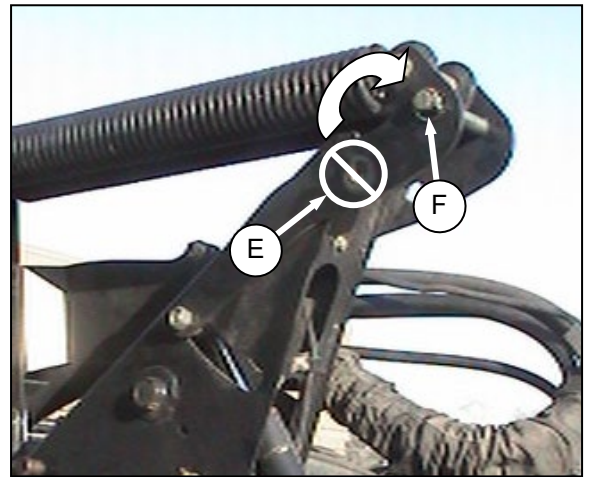

IMPORTANT

To prevent damage to the lift system when lowering header lift linkages without a header or weight box attached to windrower, ensure that float engagement pin is installed in storage location (F), and **not** installed at hole location (E).

- f. Disengage lift cylinder stops.
- g. Start engine, choose a level area and lower header to the ground.

(continued next page)

HEADER OPERATION – A SERIES

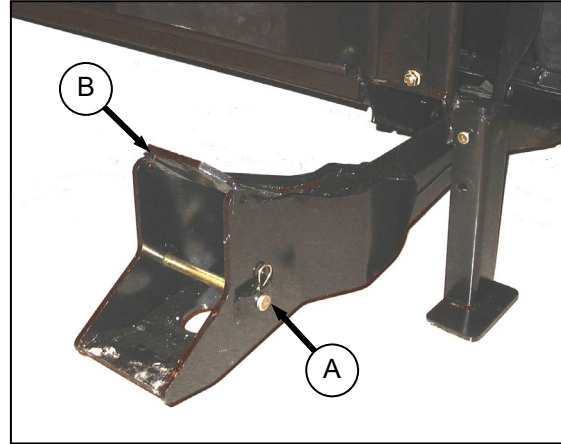
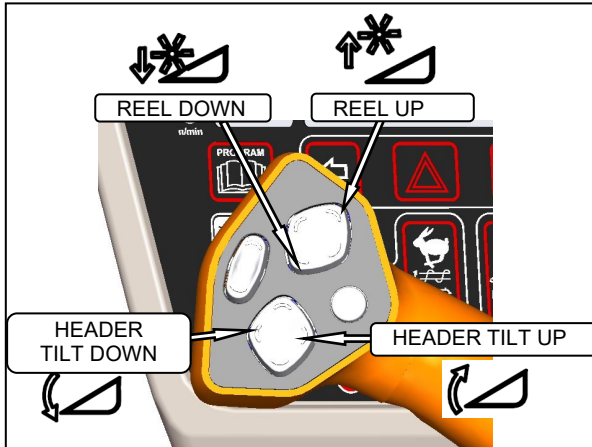

- h. Activate HEADER TILT switch on GSL to release load on center link cylinder (G).

- m. Re-install pins (A) in header boots (B).

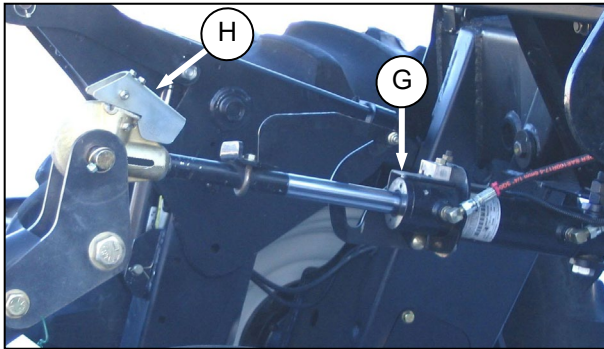

- i. Lift hook release (H).
- j. Operate the link lift cylinder with REEL UP switch on GSL to disengage the center link from the header.

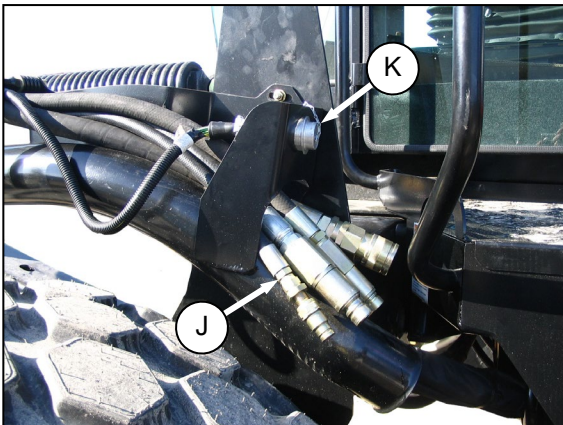

- k. Disconnect header drive hydraulics (J) and electrical harness (K). Refer to the Auger Header Operator's Manual.
- l. Slowly back windrower away from header.

HEADER OPERATION – A SERIES

6.6.3 AUGER SPEED



CAUTION

Check to be sure all bystanders have cleared the area.

6.6.3.1 A40-D Headers

On A40-D double knife headers, the auger speed can be changed independently from the reel speed with a switch on the CDM. Change auger speed as follows:

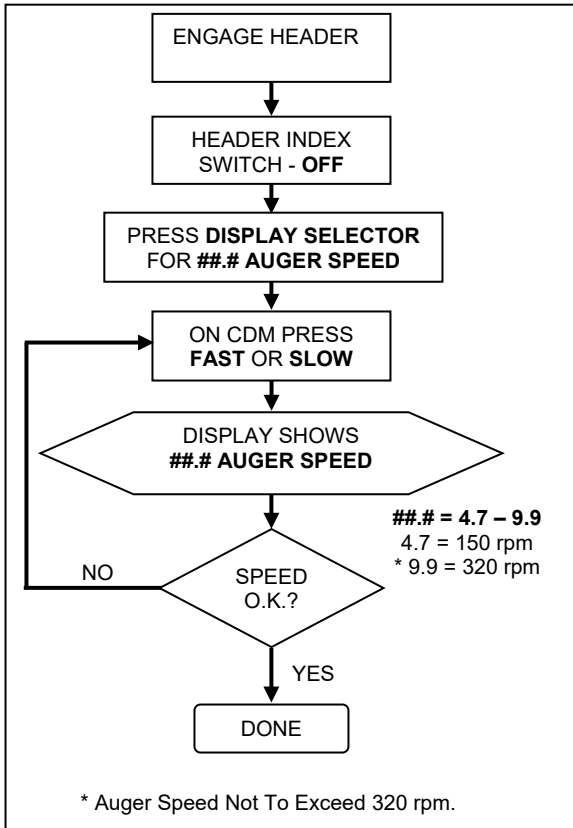

6.6.3.2 A30-S and A30-D Headers

On A30 Series auger headers, the auger speed is fixed to the knife speed.

NOTE

The auger speed can be independently changed from the knife speed by changing the drive sprocket. Refer to A30-S, A30-D & A40-D Self Propelled Windrower Headers OPERATOR'S MANUAL.

Display the auger speed as follows:

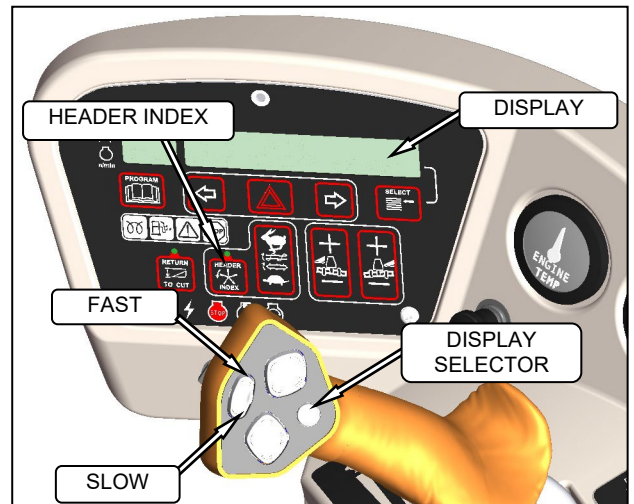
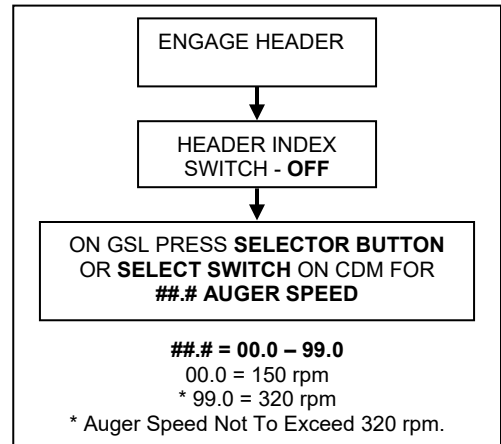

HEADER OPERATION – A SERIES

reel speed do not affect auger speed.

6.6.4 REEL SPEED

6.6.4.1 A40-D Header

The A40 reel drive is hydraulically driven and is dependent on the auger and knife speeds.

IMPORTANT

To prevent overspeeding the auger, initially set the speed of the reel and auger as follows: Subsequent adjustments to

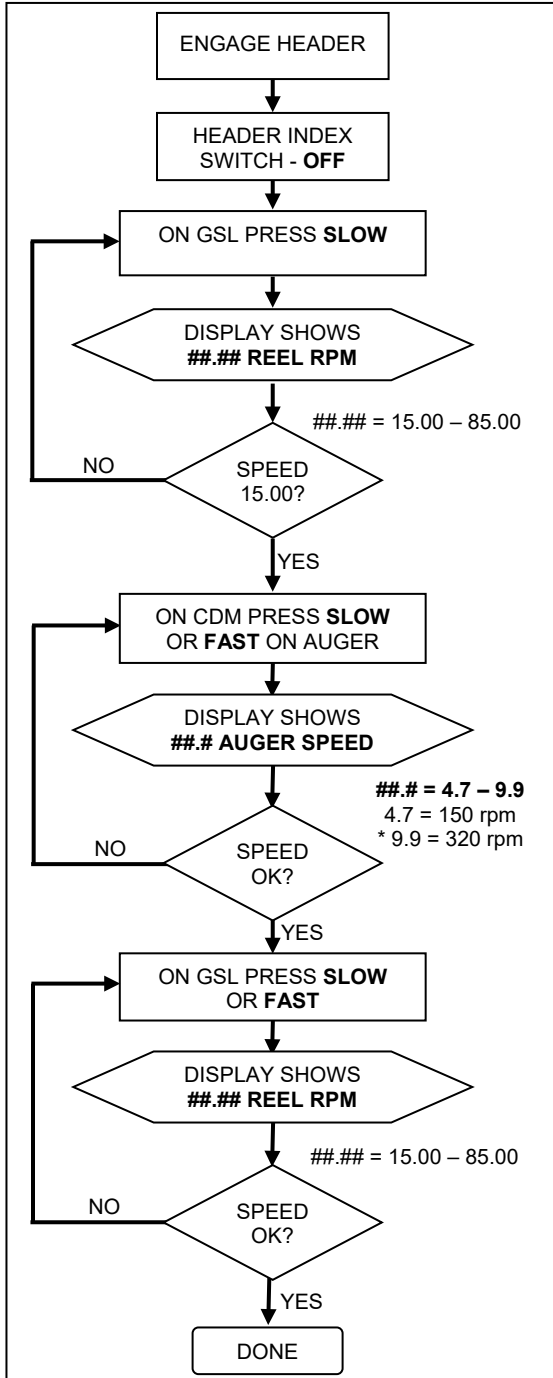

HEADER OPERATION – A SERIES

Adjust the reel speed “on the go” as follows:

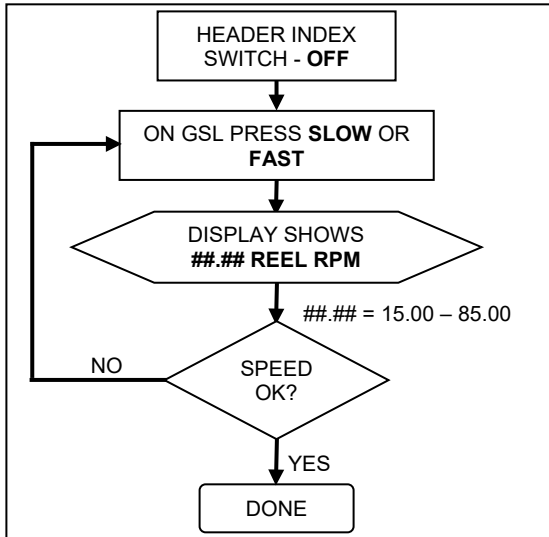

6.6.4.2 A30-S and A30-D Headers

The reel is driven by the auger, and both are dependent on the main header drive speed. The auger speed and hence the reel speed can be changed by installing a different size auger drive sprocket, or by varying the windrower engine rpm.

Display the reel speed as follows:

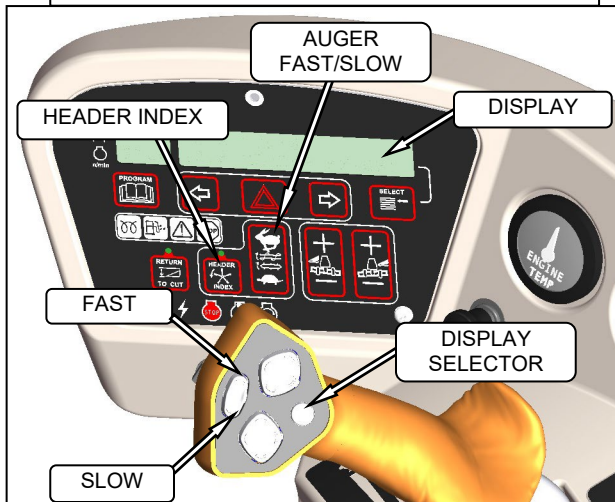
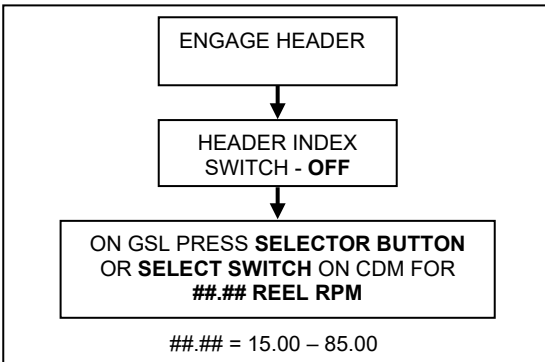

HEADER OPERATION – A SERIES

6.6.5 KNIFE SPEED

The ideal cutting speed of the knife should be such that a clean cut is achieved. Crop types and conditions usually influence the knife and forward speeds.

The windrower WCM reads a code from the header that determines the knife speed range and the minimum speed when the header is first attached to the windrower. The desired speed can be programmed on the CDM and is stored in the WCM memory so that if the header is detached and then re-attached to the windrower, the knife will operate at the original set-point.

If no header code is detected, the CDM displays NO HEADER and the knife speed reverts to a range from 0-1400 strokes per minute and the operator can then pre-set the speed.

| HEADER DESCRIPTION | | KNIFE SPEED * (Strokes Per Minute [SPM]) | |
|--------------------|------|--|---------|
| TYPE | SIZE | MINIMUM | MAXIMUM |
| Auger A40-D | All | 1400 | 1950 |
| Auger A30-S | All | 1250 | 1550 |
| Auger A30-D | All | 1550 | 1850 |

* Suggested Overload Setting – 75% of Knife Speed.

NOTE

The knife speed cannot be programmed outside the range specified for each header.

NOTE

The speed can be adjusted without shutting down the machine, although it is recommended that the windrower be stopped to enable the operator to re-program the WCM.

Display and set knife speed on-the go as follows:



CAUTION

Check to be sure all bystanders have cleared the area.

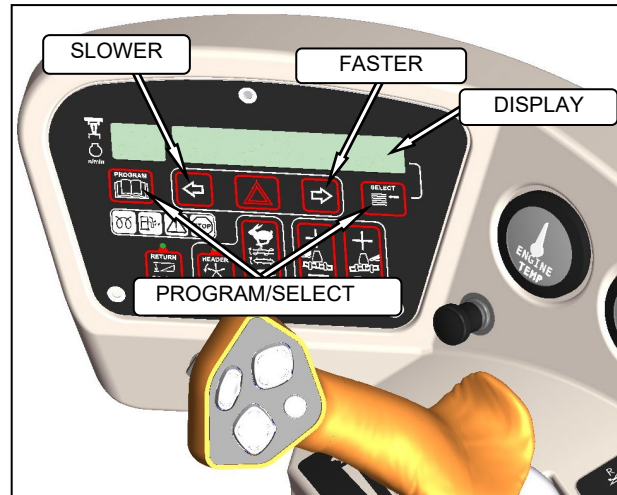
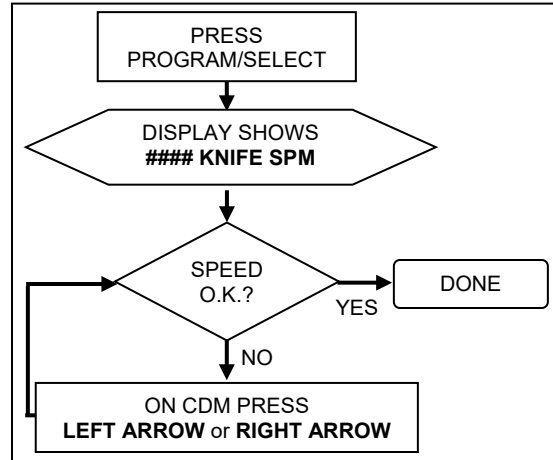

HEADER OPERATION – R SERIES

6.7 R SERIES HEADER OPERATION



The M205 is factory equipped with hydraulics and connections to run the R-Series Rotary Disc headers.

The R85 16 and 19 foot headers are factory equipped with hydraulic connections for attachment to the windrower.

The R85 13 foot header, and the R80 13 and 16 foot headers are shipped without the motor and hoses installed, and the installation of a separate motor and hose bundle is necessary.

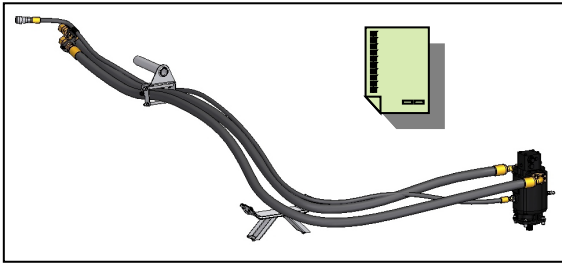

If required, obtain kit number B5456 from your MacDon dealer and install it in accordance with the instructions supplied with the kit. See above.

6.7.1 HEADER ATTACHMENT

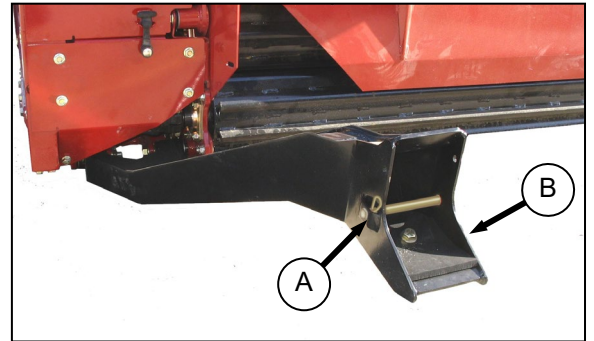

- a. Remove hairpin from pin (A), and remove pin from on left and right header boots (B) on header.

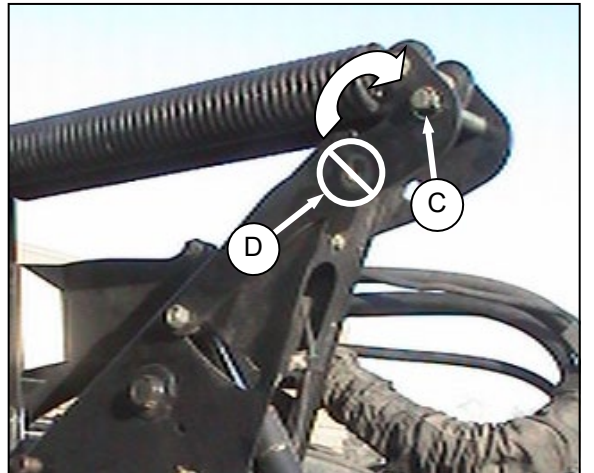

IMPORTANT

To prevent damage to the lift system when lowering header lift linkages without a header or weight box attached to windrower, ensure that float engagement pin is installed in storage location (C), and **not** installed at hole location (D).

(continued next page)

HEADER OPERATION – R SERIES



CAUTION

Check to be sure all bystanders have cleared the area.

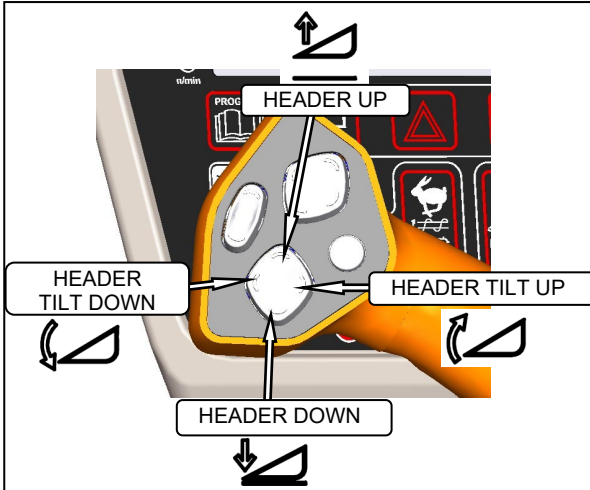

- b. Start the engine and activate header down button on the GSL to fully retract header lift cylinders.

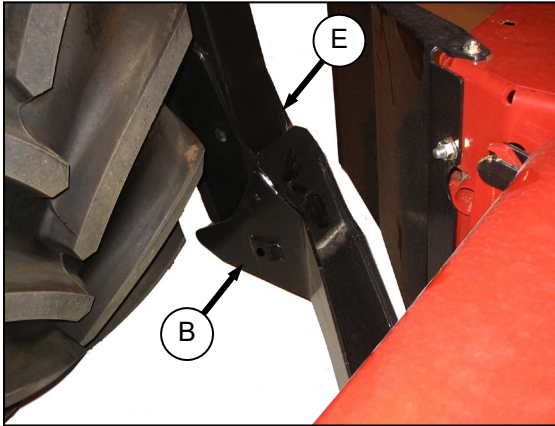

- c. Slowly drive windrower forward so that feet (E) on windrower enter boots (B) on the header. Continue to drive slowly forward until feet engage the boots, and header nudges forward

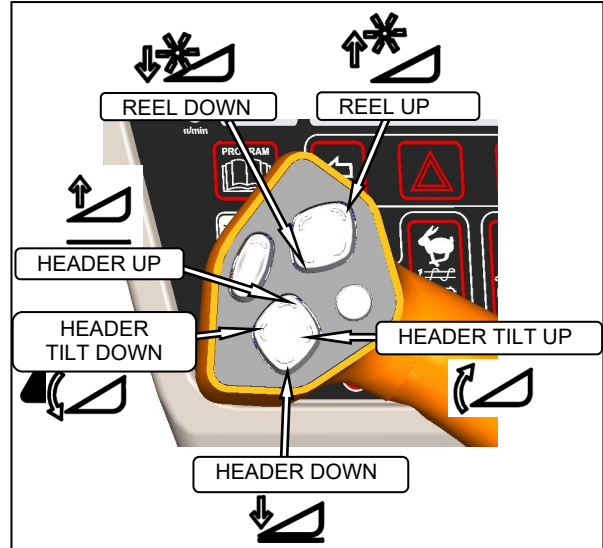

- d. Adjust the position of the center link cylinder with the REEL UP and REEL DOWN switches, and HEADER TILT switches on the GSL to position the hook above the header attachment pin.

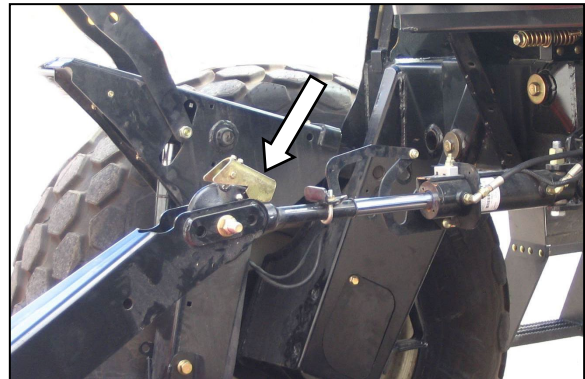

- e. Lower the center link onto the header with REEL DOWN switch until it locks into position (handle is down).
 f. Raise the header fully with the HEADER UP switch on the GSL. Stop engine and remove key.



DANGER

To avoid bodily injury from fall of raised header, always engage header lift cylinder stops when working on or around raised header.

- g. Engage lift cylinder stops on both lift cylinders.

(continued next page)

HEADER OPERATION – R SERIES

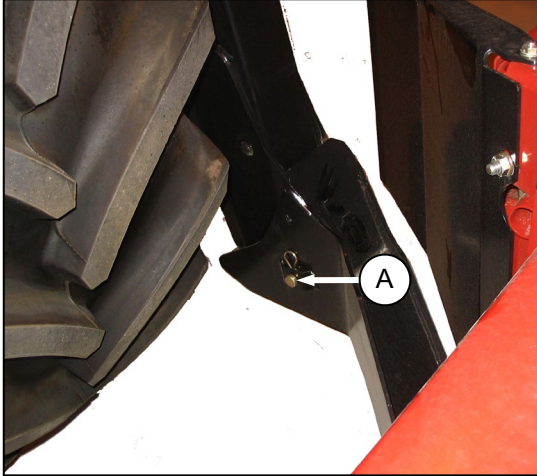

- h. Install pin (A) through each boot and foot and secure with hairpin.

IMPORTANT

Ensure pin (A) is fully inserted and hairpin is installed behind bracket.

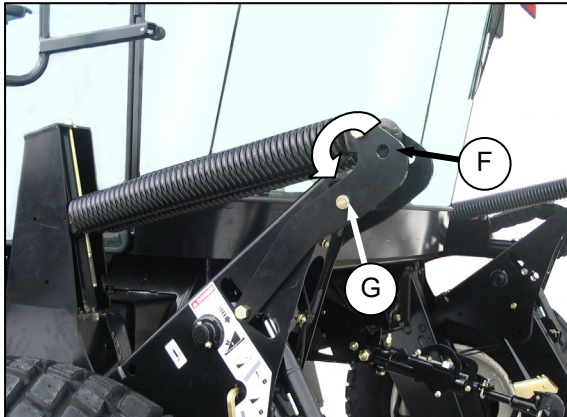

- i. Remove pin (F) from storage position in linkage and insert in hole (G) to engage float springs. Secure with hairpin.
- j. Disengage lift cylinder stops.
- k. Start engine, and activate HEADER DOWN switch on GSL to lower header fully. Stop engine and remove key.
- l. Connect header drive hydraulics and electrical harness to header. Refer to your Rotary Disc Header Operator's Manual.

HEADER OPERATION – R SERIES

6.7.2 HEADER DETACHMENT

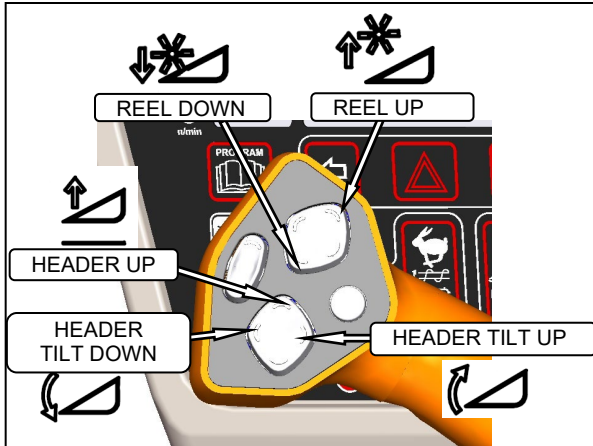

- Raise the header fully with the HEADER UP switch on the GSL. Stop engine and remove key.



DANGER

To avoid bodily injury from fall of raised header, always engage header lift cylinder stops when working on or around raised header.

- Engage lift cylinder stops on both lift cylinders.

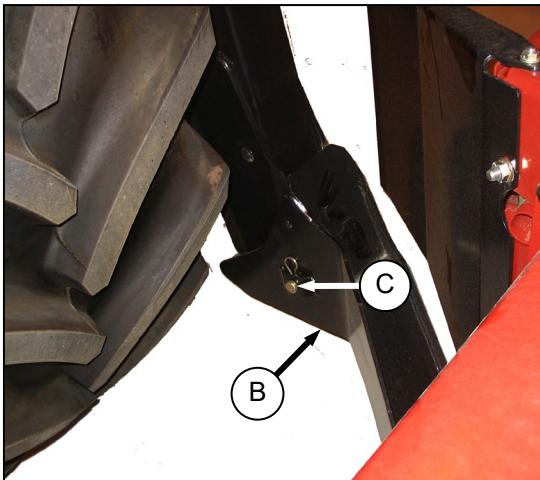

- Remove hairpin from pin (A), and remove pin from left and right header boots (B) on header.

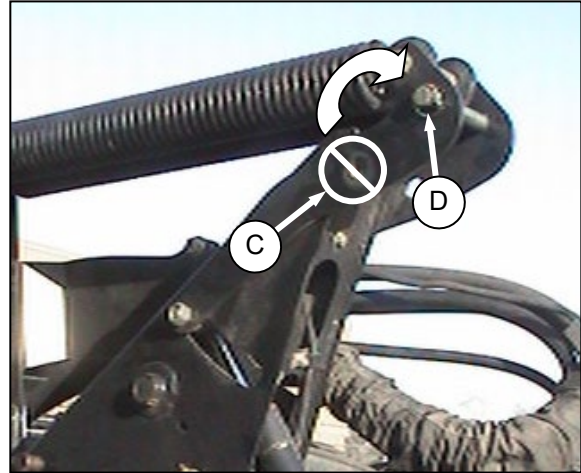

- Remove pin from location (C) to disengage float springs, and insert in storage hole (D). Secure with hairpin.

IMPORTANT

To prevent damage to the lift system when lowering header lift linkages without a header or weight box attached to windrower, ensure that float engagement pin is installed in storage location (D), and **not** installed at hole location (C).

- Disengage lift cylinder stops.
- Start engine, choose a level area and lower header to the ground.

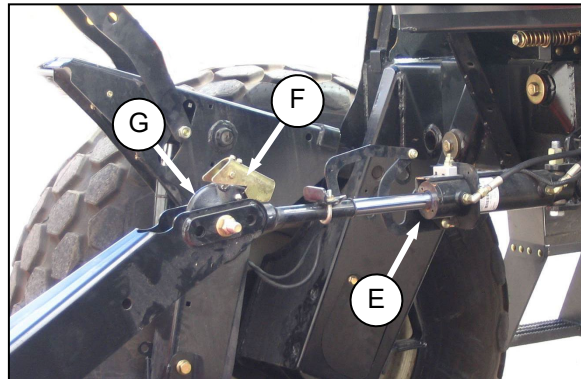

- Activate HEADER TILT switches on GSL to release load on center link cylinder (E).
- Lift hook release (F).
- Operate the link lift cylinder with REEL UP switch on GSL to disengage the center link hook (G) from the header.

HEADER OPERATION – R SERIES

- j. Disconnect header drive hydraulics and electrical harness. Refer to your Rotary Disc Header Operator's Manual.
- k. Slowly back windrower away from header.

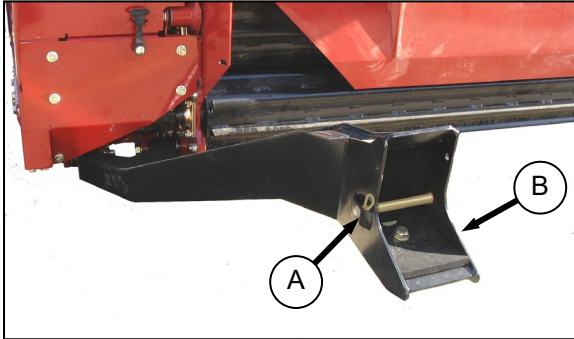

- l. Re-install pins (A) in header boots (B).

HEADER OPERATION – R SERIES

6.7.3 DISC SPEED

The header is allocated a code that the WCM reads when the header is first attached to the windrower, and the disc speed set-point automatically becomes the minimum disc speed for the header. The operator can then program the desired speed from the following table on the CDM to be stored in the WCM memory so that if the header is detached and then re-attached to the windrower, the disc will operate at the original set-point.

| CROP | CONDITION | DISC RPM * |
|------------------------------------|---------------|------------|
| Alfalfa | Heavy | 2100-2300 |
| | Light | 1800-2000 |
| Sudan, Sorghum, Haygrazer, Timothy | Tall & Stemmy | 2300-2500 |
| Short Grass | Dense | 2500 |
| | Thin | 2000-2200 |

* Suggested Overload Setting – 1300 rpm.

NOTE

Higher engine rpm may be required to engage the R85 headers. Do not exceed 1800 rpm.

NOTE

Desired disc speed will only be maintained above 1500 rpm (engine). Disc speed is not adjustable below this rpm.

Display and set the desired disc speed as follows:



CAUTION

Check to be sure all bystanders have cleared the area.

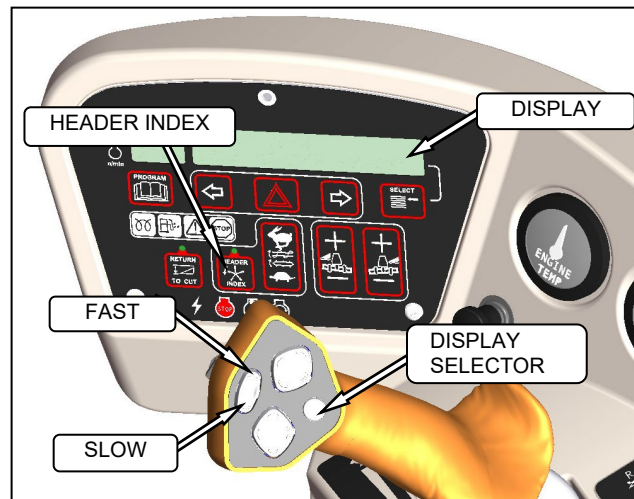
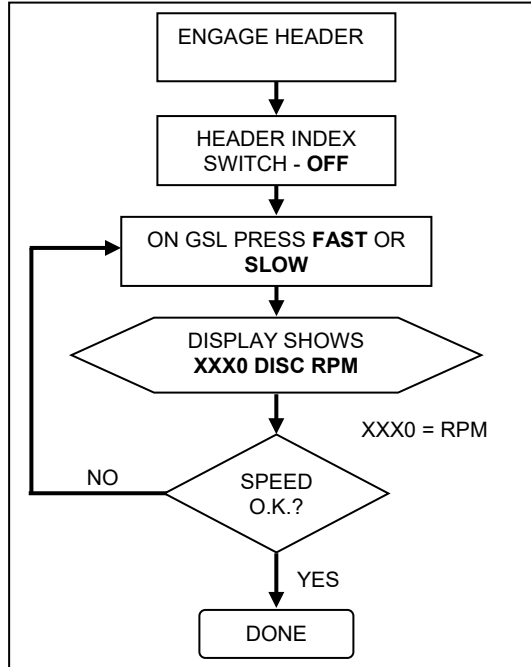

7 MAINTENANCE/SERVICE

The following instructions are provided to assist the operator in the use of the M205 Windrower. Detailed maintenance, service, and parts information are contained in the Service Instruction Manual and Parts Catalogue that are available from your dealer.

7.1 PREPARATION FOR SERVICING



WARNING

To avoid personal injury, before servicing adapter/header or opening drive covers:

- Fully lower the header. If necessary to service in the raised position, always engage lift cylinder stops.
- Disengage drives.
- Stop engine and remove key.
- Wait for all moving parts to stop.

7.1.1 WELDING PRECAUTIONS

IMPORTANT

High currents and voltage spikes associated with welding can cause damage to electronic components. Before welding on any part of the windrower or an attached header, disconnect all electronic module harness connections as well as the battery cables. These electronic modules include;

- Engine Control Module (ECM)
- Windrower Control Module (WCM)
- Cab Display Module (CDM)

7.2 RECOMMENDED SAFETY PROCEDURES

- Wear close-fitting clothing and cover long hair. Never wear dangling items such as scarves or bracelets.

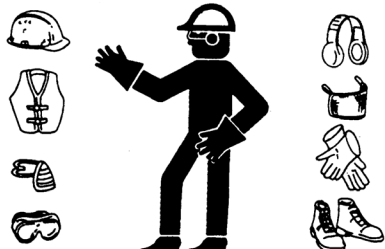

- Wear protective shoes with slip-resistant soles, a hard hat, protective glasses or goggles and heavy gloves.



- If more than one person is servicing the machine at the same time, be aware that rotating a driveline or other mechanically driven component by hand (for example, accessing a lube fitting) will cause drive components in other areas (belts, pulleys, and sickle) to move. Stay clear of driven components at all times.

- Be prepared if an accident should occur. Know where the first aid kit and fire extinguishers are located and how to use them.



- Keep the service area clean and dry. Wet or oily floors are slippery. Wet spots can be dangerous when working with electrical equipment. Be sure all electrical outlets and tools are properly grounded.



- Use adequate light for the job at hand.
- Replace all shields removed or opened for service.
- Park on a level surface when possible. Block wheels securely.
- Use only service and repair parts made or approved by the equipment manufacturer. Substituted parts may not meet strength, design or safety requirements.
- Keep the machine clean. Never use gasoline, naphtha or any volatile material for cleaning purposes. These materials may be toxic and/or flammable.

MAINTENANCE/SERVICE

7.3 MAINTENANCE SPECIFICATIONS

7.3.1 RECOMMENDED FUEL, FLUIDS AND LUBRICANTS

7.3.1.1 Fuel

| FUEL | SPEC | SULPHUR (by weight) | WATER & SEDIMENT (by vol.) | CETANE NO. °C. | LUBRI CITY |
|--------------------------------------|---------------|-----------------------------------|----------------------------------|--|----------------|
| Diesel Grade No.2 | ASTM D-975 | 0.5% Max. | 0.05% Max. | 40 Min. | 520 microns |
| Diesel Grade No.1 & 2 mix * | n/a | 1% Max. 0.5% Max. Preferred | 0.1% Max. | 45-55 Cold Weather/ High Alt. | 460 microns |

* Optional when operating temp below 0C. (32F.).

In extreme situations, when available fuels are of poor quality or problems exist which are peculiar to certain operations, additives can be used. However, the engine manufacturer recommends consultation with the fuel supplier or engine manufacturer prior to use of fuel additives. Among the situations where additives can prove useful are the following:

- A cetane improver additive can be used with low cetane fuels.
- A wax crystal modifier can help with fuels with high cold filter plugging points (CFPP).
- An anti-icer can help prevent ice formation in wet fuel during cold weather.
- An anti-oxidant or storage stability additive can help with fuel system deposits and poor storage stability.
- A lubricity enhancer can be used to increase the lubricity of fuels so that they meet the requirements given in the table on the previous page.

Diesel fuel conditioner is available from your dealer.

7.3.1.2 Fluids

| FLUID | SPEC | DESCRIPTION | USE |
|--|----------------|------------------------------|--|
| Anti-Freeze | ASTM D-4985 | Ethylene Glycol With SCA. | Equal Parts With Water* Engine Coolant |
| Air Conditioning Refrigerant | R134A | Refrigerant | Cab Air Conditioning System. |
| Air Conditioning Compressor Oil | SP-15 | Compressor Oil | Cab Air Conditioning Compressor Lubricant |

* High quality, soft, de-ionized or distilled water as recommended by supplier.

7.3.1.3 Lubricants

| LUBRICANT | SPEC/DESCRIPTION | USE |
|-------------------|--|--|
| Grease | SAE Multi-Purpose. High Temp. Extreme Pressure (EP2) Performance With 1% Max Molybdenum Disulphide (NLGI Grade 2) Lithium Base. | As Required Unless Otherwise Specified. |
| Engine Oil | SAE 15W-40 Compliant With SAE Specs For API Class SJ and CH-4 Engine Oil. | Engine Crankcase |
| Hydraulic Oil | SAE 15W-0 Compliant With SAE Specs For API Class SJ and CH-4 Engine Oil. | Windrower Drive. Header Drive. |
| Gear Lubricant | SAE 85W-140 API Service Class GL-5. Extreme Pressure Gear Lubricant. | Drive Wheel Gears Before Initial Change. |
| | SAE 75W-90 API Service Class GL-5. Fully Synthetic Gear Lubricant (SAE J2360 Preferred). | Gearbox. Drive Wheel Gears After Initial Change. |

7.3.1.4 Capacities

| ITEM | CAPACITY |
|--------------------------|-------------------------------|
| Fuel Tank | 97 U.S. Gallons (378 liters) |
| Hydraulic Reservoir | 17.2 U.S. Gallons (66 liters) |
| Gear Box | 2.2 U.S. Quarts (2.1 liters) |
| Drive Wheel | 1.5 U.S. Quarts (1.4 liters) |
| Engine Cooling System | 5.3 U.S. Gallons (20 liters) |
| Engine Crankcase | 21 U.S. Quarts (20 liters) |
| Air Cond. Refrigerant | 3.6 lb (1.63 kg) |
| Air Cond. Compressor Oil | 8.1 fl. oz. (240 cc) |

7.3.1.5 Storage

Your machine can operate at top efficiency only if clean fuel and lubricants are used.

- Use clean containers to handle all fuels and lubricants.
- Store in an area protected from dust, moisture, and other contaminants.
- Buy good quality, clean fuel from a reputable dealer.
- Avoid storing fuel over long periods of time. If you have a slow turnover of fuel in windrower tank or supply tank, add fuel conditioner to avoid condensation problems.
- Store fuel in a convenient place away from buildings.

MAINTENANCE/SERVICE

7.3.2 RECOMMENDED TORQUES

7.3.2.1 Bolts

The tables shown below give correct torque values for various bolts and capscrews.

- Tighten all bolts to the torques specified in chart unless otherwise noted throughout this manual
- Check tightness of bolts periodically, using bolt torque chart as a guide.
- Replace hardware with the same strength bolt.
- Torque figures are valid for non-greased or non-oiled threads and heads unless otherwise specified. Do not grease or oil bolts or capscrews unless specified in this manual.
- When using locking elements, increase torque values by 5%.

7.3.2.1.1 SAE Bolts

| BOLT DIA. "A" in. | NC BOLT TORQUE* | | | |
|----------------------|-----------------|-----|--------|------|
| | SAE 5 | | SAE 8 | |
| | lbf-ft | N·m | lbf-ft | N·m |
| 1/4 | 9 | 12 | 11 | 15 |
| 5/16 | 18 | 24 | 25 | 34 |
| 3/8 | 32 | 43 | 41 | 56 |
| 7/16 | 50 | 68 | 70 | 95 |
| 1/2 | 75 | 102 | 105 | 142 |
| 9/16 | 110 | 149 | 149 | 202 |
| 5/8 | 150 | 203 | 200 | 271 |
| 3/4 | 265 | 359 | 365 | 495 |
| 7/8 | 420 | 569 | 600 | 813 |
| 1 | 640 | 867 | 890 | 1205 |

* Torque categories for bolts and capscrews are identified by their head markings.

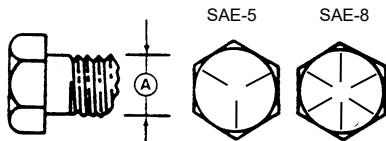

7.3.2.1.2 Metric Bolts

| BOLT DIA. "A" | STD COARSE BOLT TORQUE* | | | |
|---------------|-------------------------|------|--------|------|
| | 8.8 | | 10.9 | |
| | lbf-ft | N·m | lbf-ft | N·m |
| M3 | 0.4 | 0.5 | 1.3 | 1.8 |
| M4 | 2.2 | 3 | 3.3 | 4.5 |
| M5 | 4 | 6 | 7 | 9 |
| M6 | 7 | 10 | 11 | 15 |
| M8 | 18 | 25 | 26 | 35 |
| M10 | 37 | 50 | 52 | 70 |
| M12 | 66 | 90 | 92 | 125 |
| M14 | 103 | 140 | 148 | 200 |
| M16 | 166 | 225 | 229 | 310 |
| M20 | 321 | 435 | 450 | 610 |
| M24 | 553 | 750 | 774 | 1050 |
| M30 | 1103 | 1495 | 1550 | 2100 |
| M36 | 1917 | 2600 | 2710 | 3675 |

* Torque categories for bolts and capscrews are identified by their head markings.

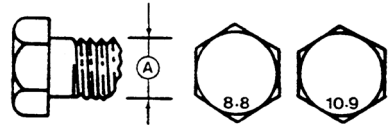

MAINTENANCE/SERVICE

7.3.2.2 Hydraulic Fittings

7.3.2.2.1 Flare Type

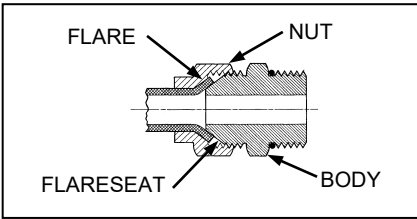

- Check flare and flare seat for defects that might cause leakage.
- Align tube with fitting before tightening.
- Lubricate connection and hand tighten swivel nut until snug.
- To prevent twisting the tube(s), use two wrenches. Place one wrench on the connector body and with the second, tighten the swivel nut to the torque shown.

| SAE NO. | TUBE SIZE O.D. (in.) | THD SIZE (in.) | NUT SIZE ACROSS FLATS (in.) | TORQUE VALUE* | | RECOMMENDED TURNS TO TIGHTEN (AFTER FINGER TIGHTENING) | |
|---------|----------------------|----------------|-----------------------------|---------------|-----|--|-------|
| | | | | ft-lbf | N·m | Flats | Turns |
| 3 | 3/16 | 3/8 | 7/16 | 6 | 8 | 1 | 1/6 |
| 4 | 1/4 | 7/16 | 9/16 | 9 | 12 | 1 | 1/6 |
| 5 | 5/16 | 1/2 | 5/8 | 12 | 16 | 1 | 1/6 |
| 6 | 3/8 | 9/16 | 11/16 | 18 | 24 | 1 | 1/6 |
| 8 | 1/2 | 3/4 | 7/8 | 34 | 46 | 1 | 1/6 |
| 10 | 5/8 | 7/8 | 1 | 46 | 62 | 1 | 1/6 |
| 12 | 3/4 | 1-1/16 | 1-1/4 | 75 | 102 | 3/4 | 1/8 |
| 14 | 7/8 | 1-3/8 | 1-3/8 | 90 | 122 | 3/4 | 1/8 |
| 16 | 1 | 1-5/16 | 1-1/2 | 105 | 142 | 3/4 | 1/8 |

* The torque values shown are based on lubricated connections as in reassembly.

7.3.2.2.2 O-Ring Type

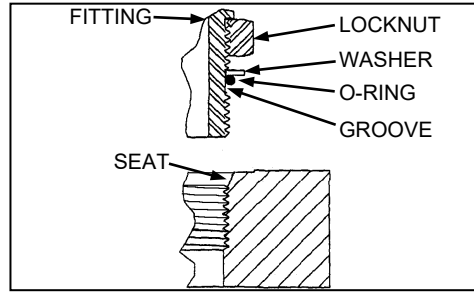

- Inspect O-ring and seat for dirt or obvious defects.

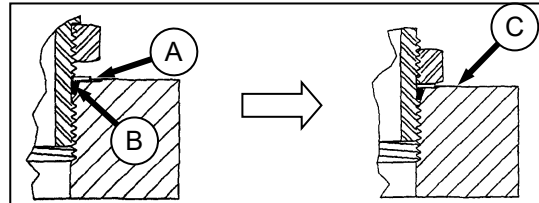

- On angle fittings, back off the lock nut until washer (A) bottoms out at top of groove (B) in fitting.
- Hand tighten fitting until back up washer (A) or washer face (if straight fitting) bottoms on part face (C) and O-ring is seated.
- Position angle fittings by unscrewing no more than one turn.
- Tighten straight fittings to torque shown.
- Tighten angle fittings to torque shown in the following table while holding body of fitting with a wrench.

| SAE NO. | THD SIZE (in.) | NUT SIZE ACROSS FLATS (in.) | TORQUE VALUE* | | RECOMMENDED TURNS TO TIGHTEN (AFTER FINGER TIGHTENING) | |
|---------|----------------|-----------------------------|---------------|-----|--|-------|
| | | | ft-lbf | N·m | Flats | Turns |
| 3 | 3/8 | 1/2 | 6 | 8 | 2 | 1/3 |
| 4 | 7/16 | 9/16 | 9 | 12 | 2 | 1/3 |
| 5 | 1/2 | 5/8 | 12 | 16 | 2 | 1/3 |
| 6 | 9/16 | 11/16 | 18 | 24 | 2 | 1/3 |
| 8 | 3/4 | 7/8 | 34 | 46 | 2 | 1/3 |
| 10 | 7/8 | 1 | 46 | 62 | 1-1/2 | 1/4 |
| 12 | 1-1/16 | 1-1/4 | 75 | 102 | 1 | 1/6 |
| 14 | 1-3/16 | 1-3/8 | 90 | 122 | 1 | 1/6 |
| 16 | 1-5/16 | 1-1/2 | 105 | 142 | 3/4 | 1/8 |
| 20 | 1-5/8 | 1-7/8 | 140 | 190 | 3/4 | 1/8 |
| 24 | 1-7/8 | 2-1/8 | 160 | 217 | 1/2 | 1/12 |

* The torque values shown are based on lubricated connections as in reassembly.

MAINTENANCE/SERVICE

7.3.3 CONVERSION CHART

| QUANTITY | INCH-POUND UNITS | | FACTOR | SI UNITS (METRIC) | |
|-------------|-----------------------------|-------------------|--------------------------|---------------------|-----------------------|
| | UNIT NAME | ABBR. | | UNIT NAME | ABBR. |
| Area | acres | acres | $\times 0.4047 =$ | hectares | ha |
| Flow | US gallons per minute | (gpm) | $\times 3.7854 =$ | liters per min | L/min |
| Force | pounds force | lbf | $\times 4.4482 =$ | Newtons | N |
| Length | inch | in. | $\times 25.4 =$ | millimeters | mm |
| | foot | ft | $\times 0.305 =$ | meters | m |
| Power | horsepower | hp | $\times 0.7457 =$ | kilowatts | kW |
| Pressure | pounds per square inch | psi | $\times 6.8948 =$ | kilopascals | kPa |
| | | | $\times .00689 =$ | megapascals | MPa |
| Torque | pound feet or foot pounds | lbf·ft or ft·lbf | $\times 1.3558 =$ | newton meters | N·m |
| | pound inches or inch pounds | lbf·in. or in·lbf | $\times 0.1129 =$ | newton meters | N·m |
| Temperature | degrees Fahrenheit | °F | $(F - 32) \times 0.56 =$ | Celsius | °C |
| Velocity | feet per minute | ft/min | $\times 0.3048 =$ | meters per min | m/min |
| | feet per second | ft/s | $\times 0.3048 =$ | meters per sec | m/s |
| | miles per hour | mph | $\times 1.6063 =$ | kilometers per hour | km/h |
| Volume | US gallons | US gal. | $\times 3.7854 =$ | liters | L |
| | ounces | oz. | $\times 29.5735 =$ | milliliters | ml |
| | cubic inches | in. ³ | $\times 16.3871 =$ | cubic centimeters | cm ³ or cc |
| Weight | pounds | lb | $\times 0.4536 =$ | kilograms | kg |

MAINTENANCE/SERVICE

7.4 ENGINE COMPARTMENT HOOD

The engine hood has two open positions. The lowest is for general maintenance such as checking and adding fluid, servicing the cooling box, etc. The highest position accommodates full access to the engine bay

- a. Open the hood at the lowest position as follows:

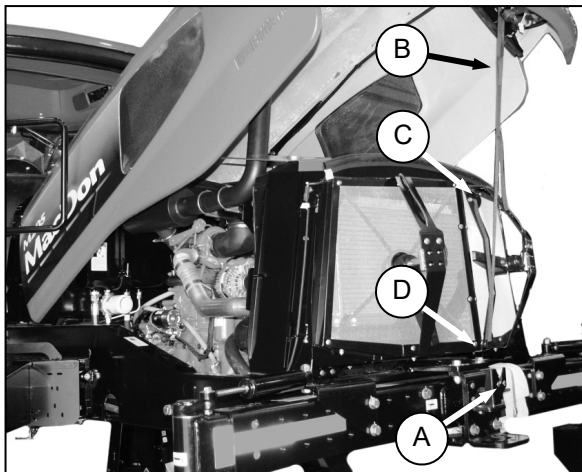

1. Locate latch (A) behind grill and lift to release hood.
2. Raise hood until strap (B), which should be looped under hooks (C) and (D), stops it at approximately a 40° angle.
3. Remove strap from hook (C) and allow hood to raise slightly further.

- b. To close hood:

1. Grasp the strap at (B) and loop under upper hook (C).

IMPORTANT

Failure to hook strap may result in it becoming entangled with the screen cleaners or the latch.

2. Pull down on strap (B), grasp the hood when within reach and lower until hood engages latch (A).

- c. Open the hood at the highest position as follows:

1. Open hood to lowest position.

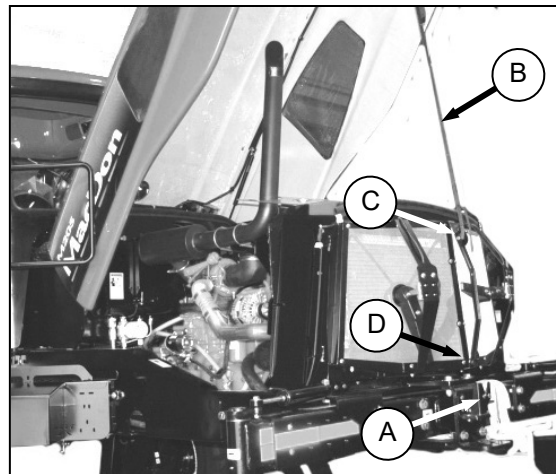

2. Remove strap from hooks (C) and (D) and allow hood to raise fully to approximately 65°

- d. To close hood:

1. Grasp the strap at (B) and loop under upper hook (C).
2. Pull down on strap and loop under lower hook (D).

IMPORTANT

Failure to hook strap may result in it becoming entangled with the screen cleaners or the latch.

3. Pull down on strap, grasp the hood when within reach and lower until hood engages latch (A).

MAINTENANCE/SERVICE

7.5 MAINTENANCE PLATFORMS

Swing away platform/stair units are provided on both sides of the windrower for access to the operator's station and engine bay maintenance.

7.5.1 OPENING/CLOSING PLATFORMS

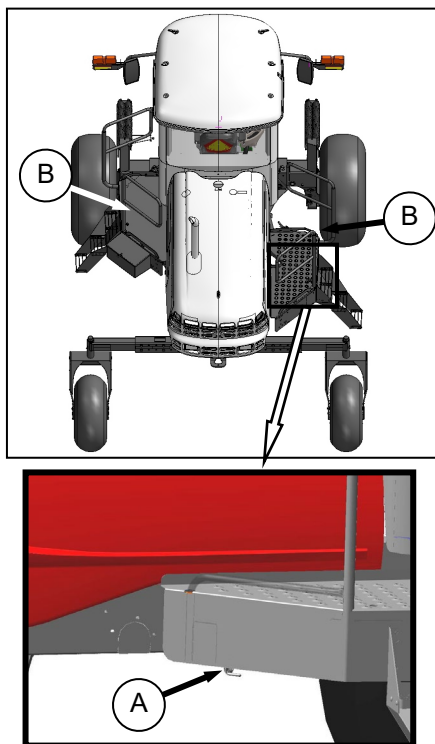

- Push latch (A) down and pull platform (B) toward walking beam until it stops and latch re-engages in open position.
- To move platform back to closed position, release latch (A) and move platform forward until it stops and latch re-engages.

7.5.2 OPENING/CLOSING PLATFORM FOR MAJOR SERVICING

To improve access to the hydraulics plumbing or battery, the platforms can be swung away from the windrower. Left side cab-forward platform shown.

- Open engine compartment hood to lowest position.

IMPORTANT

Failure to open hood will result in damage to the hood when the platform is repositioned.

- Unlock latch (A) and move platform (B) toward

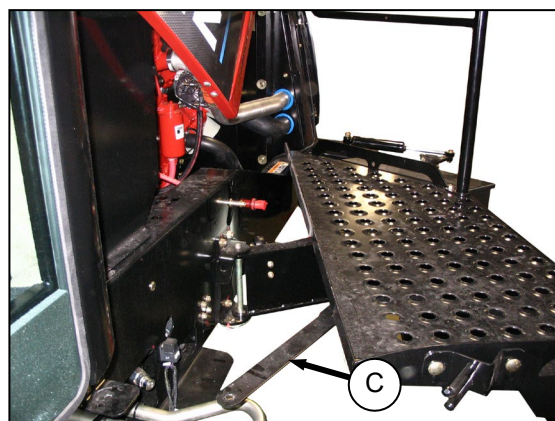

open position but do not lock in full aft position.

- Remove nut and bolt at frame and swing link (C) clear of valve block or battery.

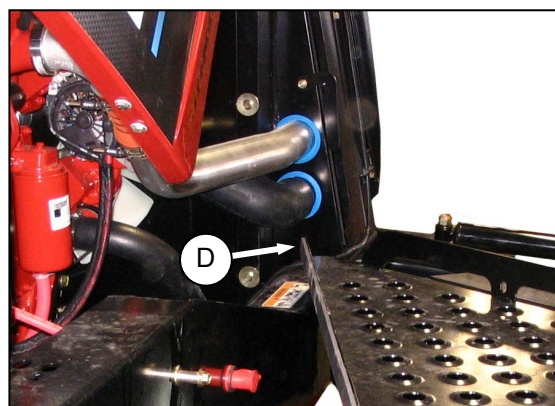

- At the same time pull front (cab-forward) end of platform away from frame while moving it towards the walking beam. Aft corner (D) of platform should project slightly into engine bay when optimum opening is reached.

(continued next page)

MAINTENANCE/SERVICE



CAUTION

Do not stand on the platform in the unlocked position. It is unstable and may result in a fall.

- e. Close platform as follows:

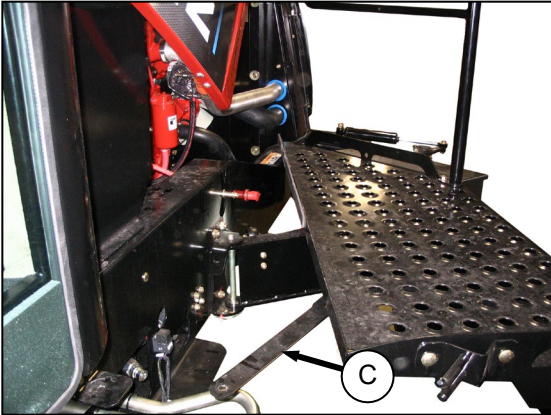

1. Swing link (C) all the way forward.
 2. Move platform front (cab-forward) end inboard while moving it away from the walking beam.
 3. Position link (C) on bracket and install bolt and nut. Tighten just enough so that link can still swivel on bracket.
 4. Move platform to closed position, ensuring it is locked.
- f. Close engine compartment hood.

7.6 LUBRICATING THE WINDROWER



WARNING

To avoid personal injury, before servicing windrower or opening drive covers, follow procedures in Section 7.1, Preparation for Servicing.

Recommend Lubricant

| LUBRICANT | SPEC | DESCRIPTION | USE |
|-----------|--------------------|---|---|
| Grease | SAE Multi-Purpose. | High Temp. Extreme Pressure (EP2) Performance With 1% Max Molybdenum Disulphide (NLGI Grade 2),Lithium Base | As Required Unless Otherwise Specified. |

The greasing points are marked on the machine by decals showing a grease gun and grease interval in hours of operation. See illustration below.

Log hours of operation and use the "Maintenance Checklist" provided to keep a record of scheduled maintenance. Refer to Section 7.13, MAINTENANCE SCHEDULE.

7.6.1 PROCEDURE



DANGER

Stop engine and remove key from ignition before leaving operator's seat for any reason. A child or even a pet could engage an idling machine.

- a. Wipe grease fitting with a clean cloth before greasing, to avoid injecting dirt and grit.
- b. Inject grease through fitting with grease gun until grease overflows fitting, except where noted.
- c. Leave excess grease on fitting to keep out dirt.
- d. Replace any loose or broken fittings immediately.
- e. If fitting will not take grease, remove and clean thoroughly. Also clean lubricant passageway. Replace fitting if necessary.

7.6.2 LUBRICATION POINTS

Refer to the illustrations on the following page for identifying the various locations that require lubrication.

MAINTENANCE/SERVICE

Lubrication Points (continued)

High Temp. Extreme Pressure
(EP2) Performance With 1%
Max Molybdenum Disulphide
(NLGI Grade 2).Lithium Base

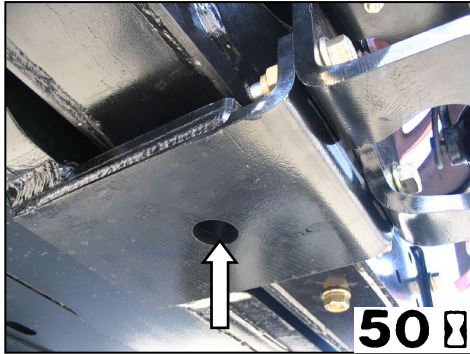

WALKING BEAM PIVOT)

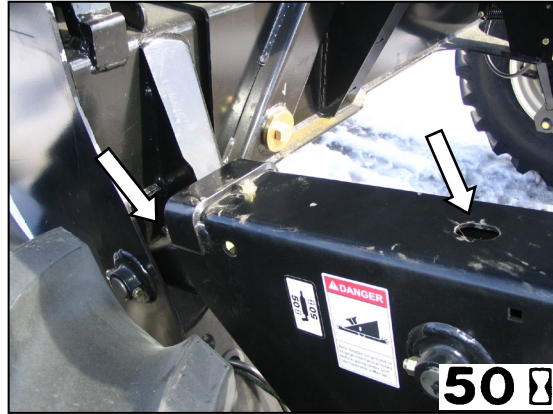

TOP LINK – TWO FITTINGS
(BOTH SIDES)



FORMED CASTER WHEEL BEARING
1 PLACE (BOTH WHEELS)

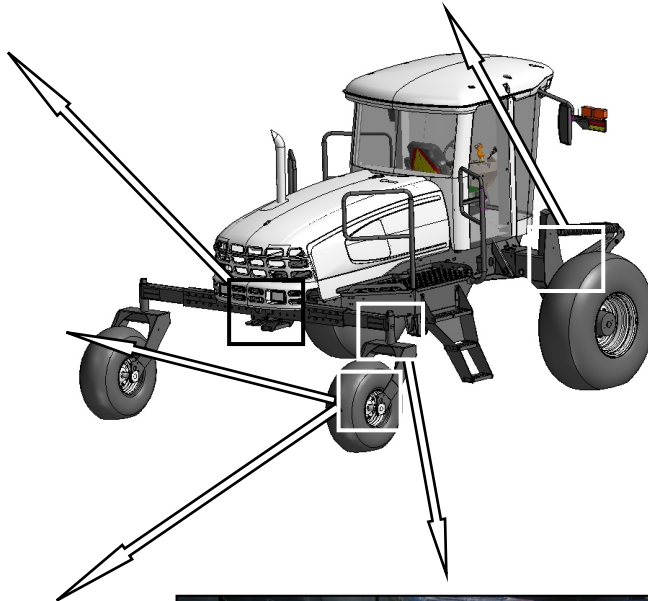

FORKED CASTER SPINDLE BEARINGS
TWO PLACES (BOTH WHEELS)



CASTER PIVOT
(BOTH SIDES)

MAINTENANCE/SERVICE

7.7 OPERATOR'S STATION

7.7.1 SEAT BELTS

- a. Keep sharp edges and items that can cause damage away from the belts.
- b. From time to time, check belts, buckles, retractors, tethers, slack take-up system and mounting bolts for damage.
- c. Replace all parts that have damage or wear.
- d. Replace belts that have cuts that can weaken the belt.
- e. Check that bolts are tight on the seat bracket or mounting.
- f. Keep seat belts clean and dry. Clean only with a soap solution and warm water. DO NOT use bleach or dye on the belts, as this may weaken the material.

7.7.2 SAFETY SYSTEMS

Perform the following checks on the operator's presence and engine lock-out systems annually or every 500 hours whichever occurs first.

7.7.2.1 Operator's Presence System

- a. With the windrower engine running, place the GSL in Neutral and turn the steering wheel until it locks.
- b. With everyone clear of the machine, engage header drive switch;
 1. After header drives are running, stand up out of the seat. In approximately 5 seconds the header should shut off.
 2. If not, the operator presence system requires adjustment. See your MacDon dealer.

NOTE

To restart the header, the operator must move the header engage switch to "OFF" position and back to the "ON" position again.

- c. With the engine running, position the GSL in Neutral and in N-DETENT;
 1. Swivel the operator's station but do not lock into position.
 2. Move GSL out of N-DETENT. The engine should shut down and the lower display will flash "LOCK SEAT BASE ---> CENTER STEERING WHEEL ---> NOT IN NEUTRAL".
 3. Swivel and lock the operator's station and the display should return to normal.

4. If the engine does not shut down, the seat position switches require adjustment. See your MacDon dealer.
- d. With the windrower moving at less than 5 mph (8 km/h);
 1. Stand up out of the seat.
 2. The CDM will flash "NO OPERATOR" on the upper line, and "ENGINE SHUTDOWN 5...4...3...2...1...0" on the lower line accompanied by a steady tone. At "0", the engine shuts down.
 3. If the engine does not shut down, the operator presence system requires adjustment. See your MacDon dealer.
- e. With the windrower moving at more than 5 mph (8 km/h);
 1. Stand up out of the seat.
 2. The CDM beeps once and displays "NO OPERATOR" on the lower line.
 3. If not, the operator presence system requires adjustment. See your MacDon dealer.

7.7.2.2 Engine Interlock

- a. With the engine shut down and the header drive switch engaged, try to start the engine. If the engine turns over, the system requires adjustment. See your MacDon dealer.
- b. With the engine shut down, steering wheel not centered, and the GSL in neutral but not in N-DETENT, try to start the engine. The CDM will flash "NOT IN NEUTRAL" on the display upper line, and "CENTER STEERING WHEEL" on the lower line, accompanied by a short beep with each flash, and the engine should not turn over. If the engine turns over, the system requires adjustment. See your MacDon dealer.

A properly functioning system should operate as follows, if not, see your MacDon dealer.

- The starter should engage ONLY when the GSL is in N-DETENT, steering wheel locked in the CENTER position, and the header drive switch is in the OFF position.
- Under the above conditions, the brake should engage and the machine should not move after engine start-up.
- The steering wheel should not lock with the engine running and the GSL is out of the N-DETENT.
- The machine should not move with the engine running and with the steering wheel still centered, when the GSL is pulled straight out of N-DETENT (not in forward or reverse).

MAINTENANCE/SERVICE

7.7.3 GSL ADJUSTMENTS

7.7.3.1 GSL Lateral Movement

The GSL should easily move into the N-DETENT by itself. Adjust the lateral pivot resistance as follows:



DANGER

Stop engine and remove key from ignition before leaving operator's seat for any reason. A child or even a pet could engage an idling machine.

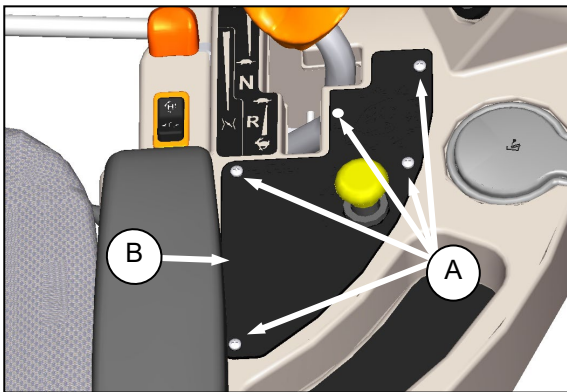

- Remove the five screws (A) securing control panel (B) to console, remove panel and store in the tray.

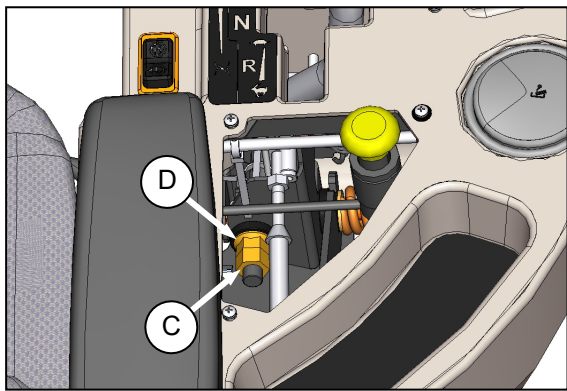

- Back-off the jam nut (C) and turn nut (D) to either tighten or loosen the pivot. The nut should be tightened to snug and then backed off $\frac{1}{2}$ turn.
- Tighten jam nut (C).
- Check movement of GSL.
- Reinstall the control panel (B) with the five screws (A).

7.7.3.2 GSL Fore-Aft Movement

The GSL should remain as positioned by the operator and yet can be moved without excessive force. The spring is set at the factory to 1.25 in. (32 mm) shown on the illustration. Adjust as follows:

- Move the console fully forward to ease accessibility from the underside of the console.

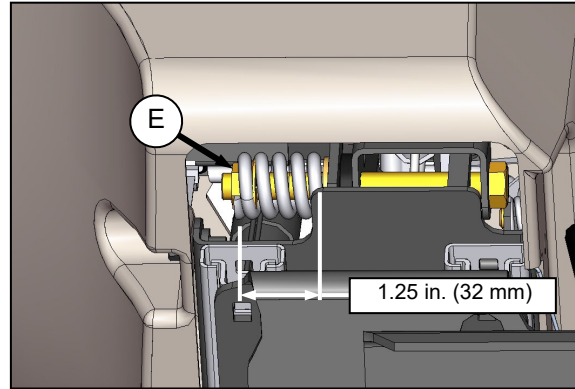

- To increase the pivot resistance, turn the nut (E) clockwise to compress the spring.
- To decrease the resistance, turn the nut (E) counterclockwise to release the spring tension.

MAINTENANCE/SERVICE

7.7.4 STEERING ADJUSTMENTS

7.7.4.1 Steering Link Pivots

The following checks should be performed annually:



DANGER

Stop engine and remove key from ignition before leaving operator's seat for any reason. A child or even a pet could engage an idling machine.

- Place GSL in N-DETENT, shutdown engine and remove key
- Check for evidence of interference of moving parts with hoses, tubes, other linkages.

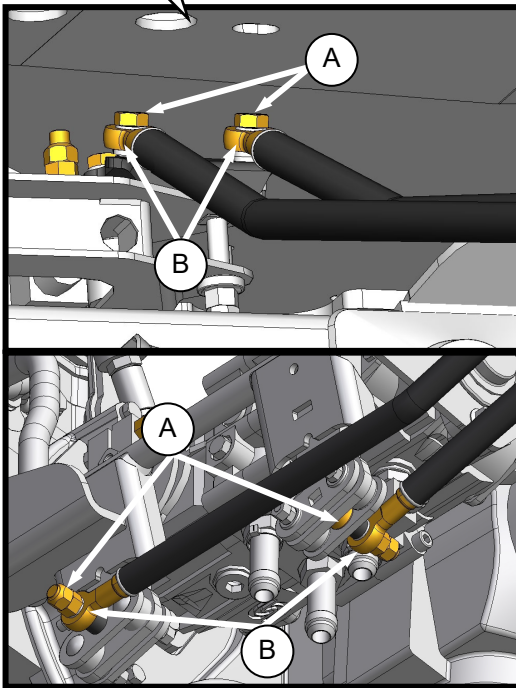

- Check steering rod bolts (A) for looseness and ball joints (B) for any perceptible play or movement.

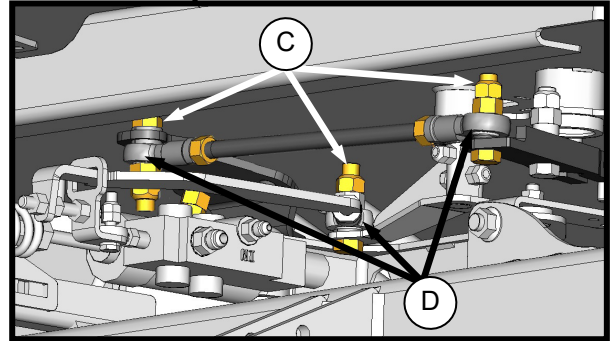
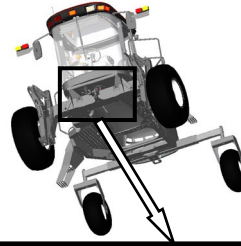

- Check steering link bolts (C) for looseness and ball joints (D) for any perceptible play or movement.
- If bolts are loose:

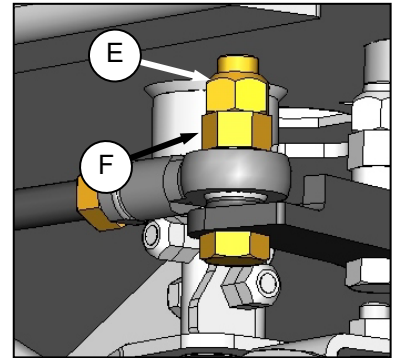

- Back off jam-nut (E).
 - Tighten inside nut (F) to 70-80 ft·lbf (95-108 N·m).
 - Hold inside nut (F) and tighten jam-nut (E) to 60-70 ft·lbf (81-95 N·m).
- If steering link ball joints (B) or steering rod ball joints (D) are loose, they should be replaced. See your MacDon dealer or refer to the Technical Service Manual for replacement procedures.
 - After replacing parts or making adjustments, perform checks for neutral interlock and steering lock. Refer to Section 7.7.2. Safety Systems.

7.7.4.2 Steering Chain Tension



DANGER

Stop engine and remove key from ignition before leaving operator's seat for any reason. A child or even a pet could engage an idling machine.

- a. Check steering for binding or excessive play which may be the result of the steering chain being too tight or too loose. If the chain tension requires adjustment, proceed as follows:
- b. Swivel the operator's station to position steering column close to the door.

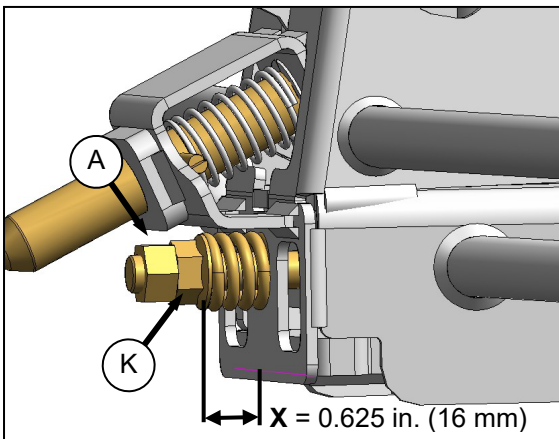

- c. At the base of the steering column, check dimension "X" at spring (H). It should be 0.625 inches (16 mm).
- d. Adjust dimension as follows:
 1. Loosen nut (A) and turn nut (B) to achieve 0.625 inches (16 mm) dimension.
 2. Tighten nut (A) against nut (B) to secure position.
 3. Check that steering chain is taut and steering shaft is free to rotate.

MAINTENANCE/SERVICE

7.7.5 PARK BRAKE

The brake is applied when the interlock is fully engaged. To engage the interlock and hence the brake, the GSL must be in the N-DETENT position and the steering wheel centered.

7.7.5.1 Interlock Switch



DANGER

Stop engine and remove key from ignition before leaving operator's seat for any reason. A child or even a pet could engage an idling machine.

The GSL switch is located inside the console but can easily be removed for adjustment or replacement. Check that GSL contacts switch lever and pushes plunger. Adjust or replace switch as follows:

- Place GSL in N-DETENT, shutdown engine and remove key.

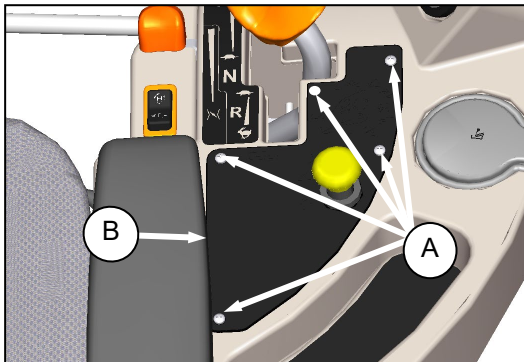

- Remove the five screws (A) securing control panel (B) to console, remove panel and store in the tray.

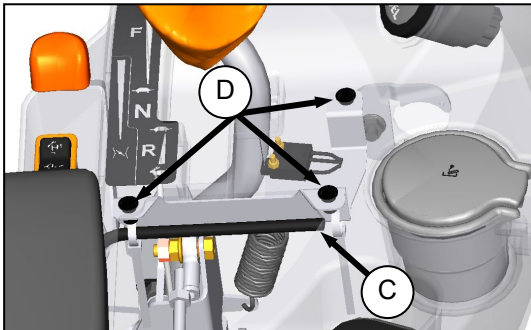

- From inside the console pull switch support (C) so that rubber nuts (D) pull out of mounting holes and remove switch support from console.

- Adjust switch (E) as follows:

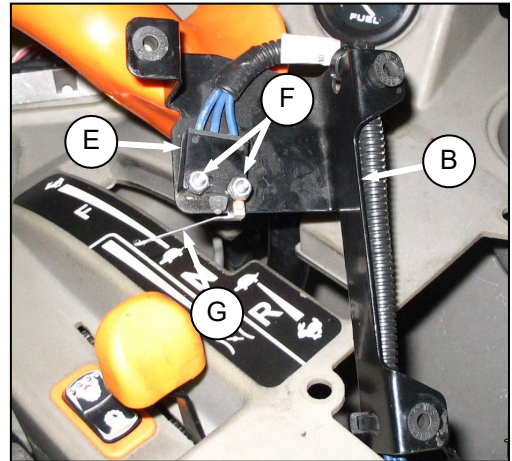

- Loosen screws (F) and rotate switch on support sufficiently so that GSL will contact switch lever (G) and push in the plunger.
 - Tighten screws (F).
- Replace switch as follows:

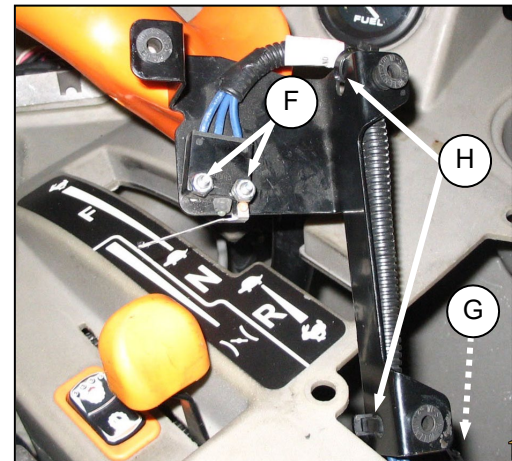

- Disconnect wiring harness at connector (G).
- Cut nylon ties (H).
- Remove screws (F) and remove switch.
- Install new switch on support with screws.
- Secure harness to support (C) with nylon ties (H).
- Connect harness to console wiring (G).

(continued next page)

MAINTENANCE/SERVICE

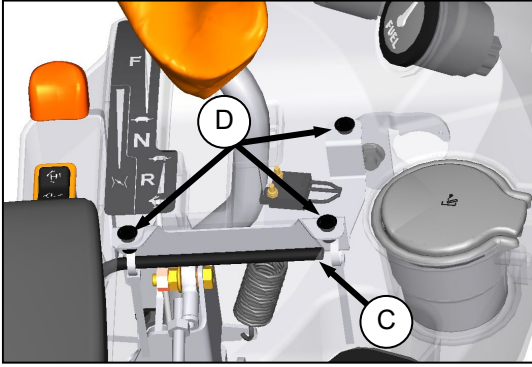

- f. Position switch support (C) inside console and push rubber nuts (D) into holes.
- g. Check operation of switch.

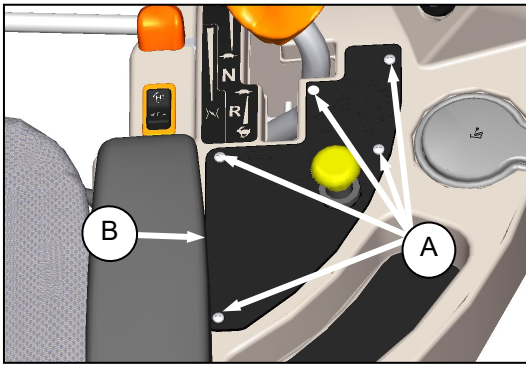

- h. Reinstall control panel (B) with five screws (A).

MAINTENANCE/SERVICE

7.7.6 HVAC SYSTEM

7.7.6.1 Fresh Air Intake Filter

The fresh air filter is located under the right cab-forward side platform and should be serviced every 50 hours under normal conditions and more frequently in severe conditions. Service the filter as follows:



DANGER

Stop engine and remove key from ignition before leaving operator's seat for any reason. A child or even a pet could engage an idling machine.

- a. Move right cab-forward side platform towards rear (cab-forward) of windrower to expose intake housing.

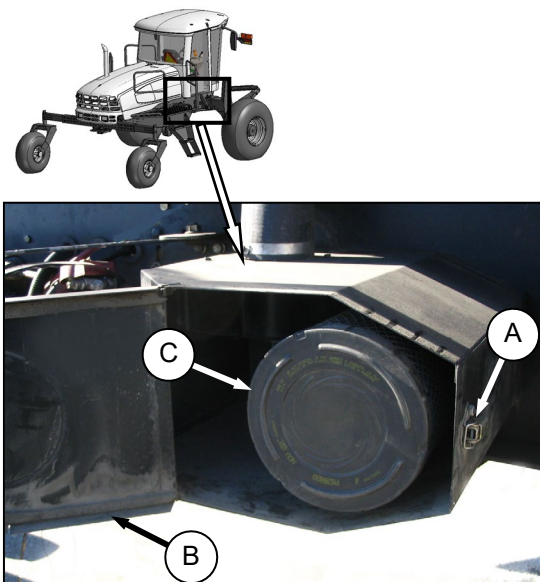

- b. Release latch (A) and open filter housing door (B).
- c. Pull filter (C) out of housing.
- d. Clean filter as follows:
 1. Pat sides of element gently to loosen dirt. Do not tap element against a hard surface.
 2. Using a Dry Element Cleaner Gun, clean element with compressed air.
 3. Hold nozzle next to inner surface, and move up and down pleats.

IMPORTANT

Air pressure must not exceed 100 psi (700 kPa). Do not direct air against outside of element, as dirt might be forced through to inside.

4. Repeat steps 1. to 3. to remove additional dirt as required.
- e. Inspect filter before installing as follows:
 1. Hold a bright light inside element and check carefully for holes. Discard any element which shows the slightest hole.
 2. Be sure outer screen is not dented. Vibration would quickly wear a hole in the filter.
 3. Be sure filter gasket is in good condition. If gasket is damaged or missing, replace element
- f. If element is coated with oil or soot, replace the element.
- g. Clean interior of filter housing.
- h. Reinstall clean/new filter as follows:
 1. Slide filter (C) into housing and onto intake.
 2. Push on rim of filter to fully engage intake.
 3. Close and latch housing door (B).
- i. Move platform back into locked forward position.

MAINTENANCE/SERVICE

7.7.6.2 Return Air Cleaner

The return air filter is located behind the operator's seat on the cab wall and should be serviced every 100 hours as follows:



DANGER

Stop engine and remove key from ignition before leaving operator's seat for any reason. A child or even a pet could engage an idling machine.

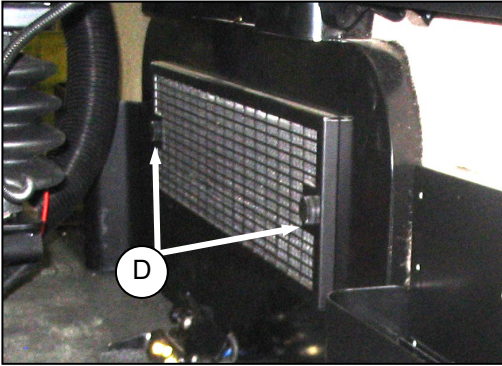

- a. Unscrew the two knobs (D) attaching cover and filter to cab wall, and pull off the cover and filter assembly.

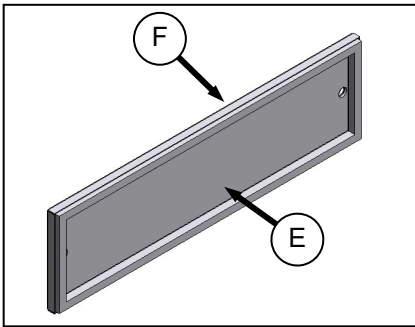

- b. Separate the filter (E) from the cover (F).
- c. Clean the electrostatic filter as follows:
 1. Mix a solution of warm water and detergent in a suitable container so that the filter can soak for a few minutes.
 2. Agitate to flush out the dirt.
 3. Rinse with clean water and dry with compressed air.
 4. Inspect filter for damage, separation, and holes. Replace if damaged.
- d. Assemble the cleaner (E) and cover (F) and position on cab wall over opening.
- e. Secure to cab wall with knobs (D).

7.7.6.3 A/C Condenser

The air conditioning condenser should be cleaned daily with compressed air and more frequent cleaning may be necessary in severe conditions. Cleaning the condenser can be done at the same time as the radiator, oil cooler, and charge air cooler. Refer to Section 7.9 COOLING BOX.

7.7.6.4 A/C Evaporator

The air conditioning evaporator should be checked annually for cleanliness. If the air conditioning system produces insufficient cooling, a possible cause is clogged evaporator fins. Fins will clog up from the side opposite the blowers.

The evaporator is located inside the heating air conditioning unit under the cab. To clean the evaporator, proceed as follows:



DANGER

Stop engine and remove key from ignition before leaving operator's seat for any reason. A child or even a pet could engage an idling machine.

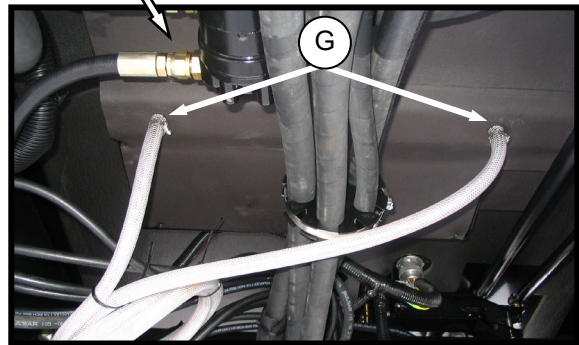
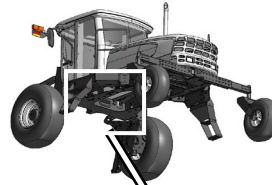

- a. Loosen the clamps (G) on the two drain hoses and pull the hoses off the air conditioning drain tubes.

(continued next page)

MAINTENANCE/SERVICE

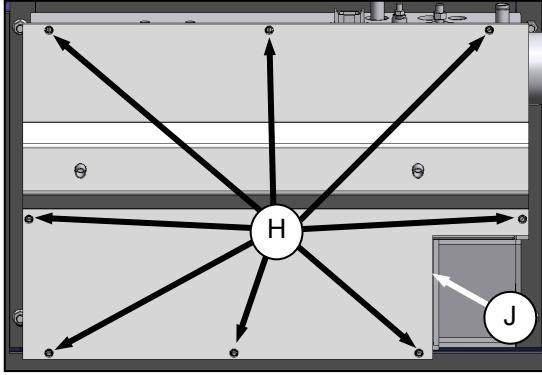

- b. Remove the eight screws (H) that attach the cover (J) and remove the cover.



WARNING

To avoid cuts from evaporator fins, do not use bare hands to brush away clogs.

- c. Use a vacuum or compressed air to remove dirt from inside the unit.
- d. Blow compressed air through the evaporator fins from the blower side first as shown. Direct the air straight into the evaporator to prevent fin damage. A nozzle extension would make this procedure easier.

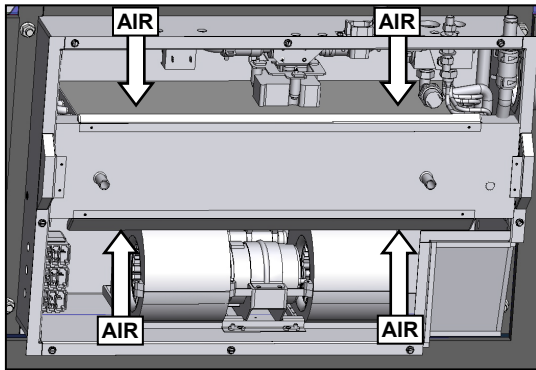

- e. Repeat the previous step from the side opposite the blowers.
- f. If dirt is still present, soak evaporator in water to loosen dirt, and then blow out with compressed air.
- g. Straighten any bent fins.
- h. Reposition cover (J) and attach with eight screws (H).
- i. Reattach drain hoses to drain tubes and secure with hose clamps (G).

7.7.6.5 A/C Compressor Protection

The compressor is protected from excessively low and high pressures by two switches that shut down the compressor to prevent damage to the system. These switches do not require any regular servicing or maintenance, so if problems occur and the switches are suspect, contact your dealer.

If the compressor cycles rapidly due to rapid pressure changes, the CDM displays a warning "CHECK A/C SYSTEM". Contact your dealer.

7.7.6.6 Refrigerant and Oil

IMPORTANT

Perform the following steps whenever the machine is first started after storage for more than one week:

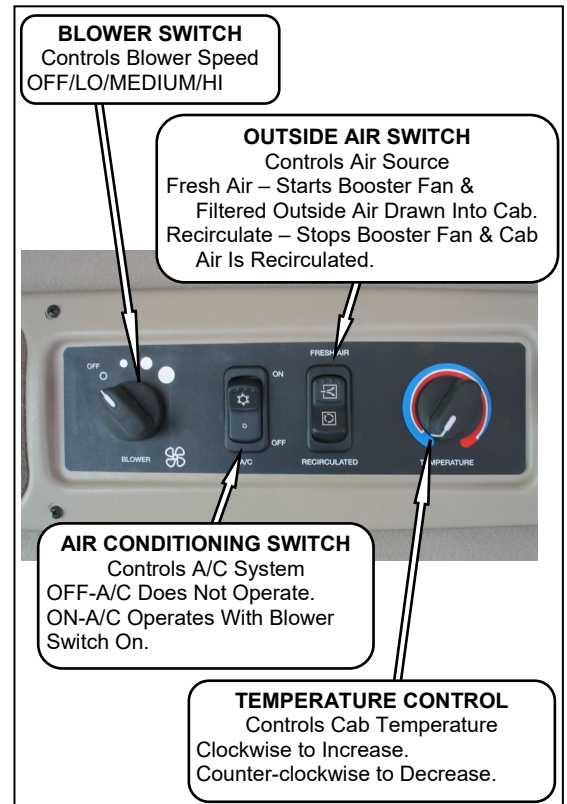

1. Turn blower switch to first position, turn temperature control switch to maximum heating, and A/C control to "OFF".
2. Start engine and operate at low idle until engine is warm.
3. Click A/C switch from "OFF" to "ON" for one second, then back to "OFF" for 5 to 10 seconds. Repeat this step ten times.

7.8 ENGINE



CAUTION

- Never operate engine in a closed building. Proper ventilation is required to avoid exhaust gas hazards.
- Keep the engine clean. Straw and chaff on a hot engine are a fire hazard.
- Never use gasoline, naphtha or any other volatile material for cleaning purposes. These materials are toxic and/or flammable.

7.8.1 GENERAL ENGINE INSPECTION

Have the overhead valve lash checked and adjusted every 5000 hours or 4 years by your Windrower dealer.

A general engine inspection, including the fuel injection pump and nozzle inspection, is recommended every 2000 hours. See your dealer.

MAINTENANCE/SERVICE

7.8.2 MANUALLY TURNING ENGINE

To manually turn the engine with the flywheel, an access hole is provided on the left cab-forward side for a barring tool that is available from Cummins.

Manually turn engine as follows:

IMPORTANT

Ensure nothing falls into gearbox oil reservoir.



DANGER

Stop engine and remove key from ignition before leaving operator's seat for any reason. A child or even a pet could engage an idling machine.

- Remove key from ignition.
- Move platform on right cab-forward side of machine to open position to allow access to the battery.

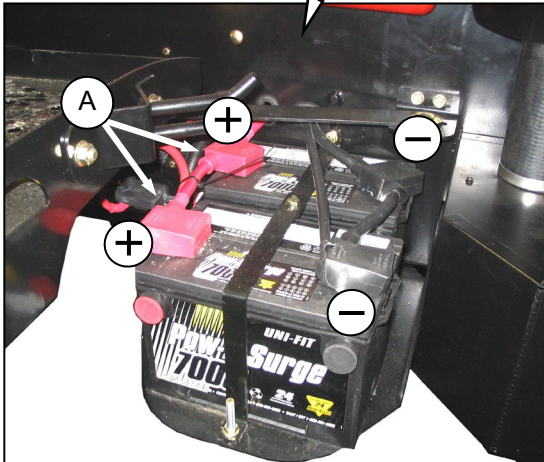
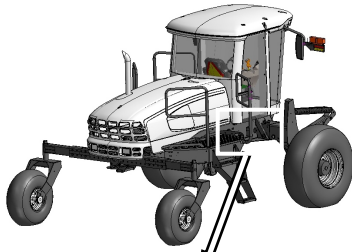

- Remove red plastic covers (A) from positive cable clamps. Loosen the clamps and remove cable from batteries.
- Open engine compartment hood to lowest position. See Section 7.4 ENGINE COMPARTMENT HOOD.

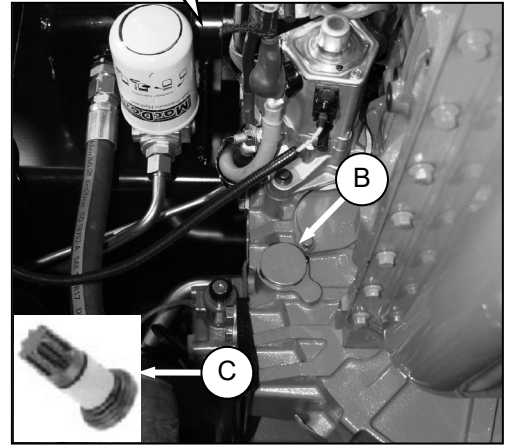
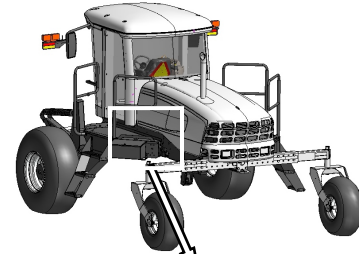

- Clean area around the plastic cap on access hole (B). Remove the cap.
- Insert the tool (C) into the flywheel housing until it engages the ring gear.
- Attach a 1/2 inch square drive ratchet or breaker bar and turn.
- Remove barring tool and clean oil from around access hole.
- Clean plastic cap and reinstall in hole with silicone sealant.
- Reconnect the battery.
- Close hood and move maintenance platform back to working position.

MAINTENANCE/SERVICE

7.8.3 OIL LEVEL

Check engine oil level frequently and watch for any signs of leakage.

NOTE

During the break-in period, a higher than usual oil consumption should be considered normal.

Check the oil level as follows:

- Stop the engine and remove the key. Wait about 5 minutes.
- Open engine compartment hood to lowest position. See Section 7.4 ENGINE COMPARTMENT HOOD.

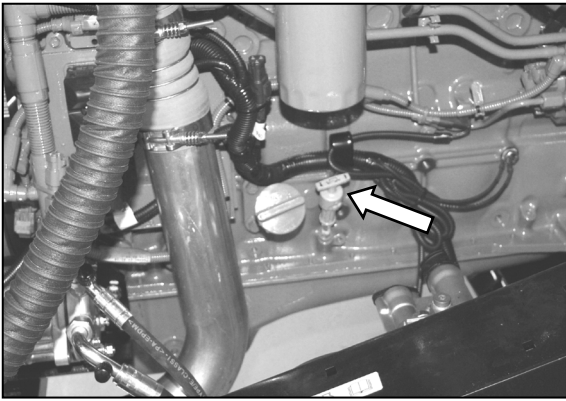

- Remove dipstick by turning it counterclockwise to unlock and remove.
- Wipe clean, reinsert in engine and remove.

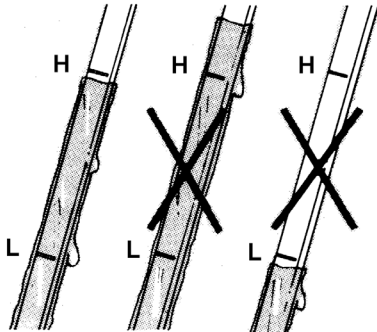

- Oil level should be between LOW and HIGH marks.
- Replace dipstick and turn it clockwise to lock.

- Add oil as follows if level is below the LOW mark: One U.S. qt. (1 litre) will raise the level from LOW to HIGH.



CAUTION

Do not fill above the HIGH mark.

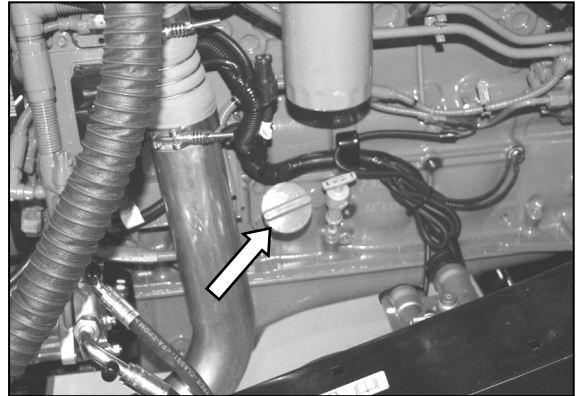

- Remove filler cap by turning it counterclockwise.
 - Carefully pour the oil. Use SAE 15W-40 Compliant With SAE Specs for API Class SJ and CH-4 Engine Oil. A funnel is recommended to avoid spillage.
 - Replace oil filler cap and turn it clockwise until snug.
- Close engine compartment hood.

MAINTENANCE/SERVICE

7.8.4 CHANGING OIL AND OIL FILTER

NOTE

The engine should be warm prior to changing the oil.

- Stop the engine and remove the key.
- Place a drain pan of about 6 U.S. gallons (24 litres) under the engine oil drain.

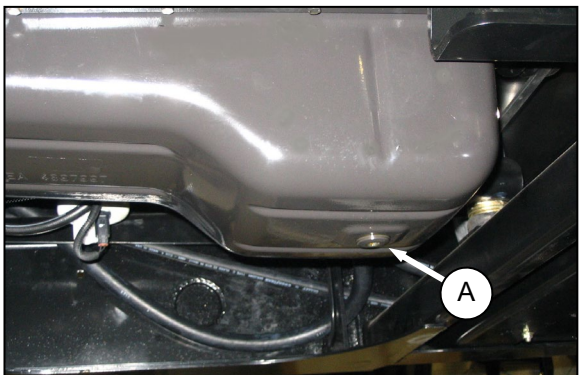

- Remove oil pan drain plug (A) and allow the oil to completely finish draining.
- Check the condition of the used oil. If either of the following is evident, have your dealer correct the problem before starting the engine:
 - Thin black oil indicates fuel dilution.
 - Milky discoloration indicates coolant dilution.
- Open engine compartment hood to lowest position. See Section 7.4 ENGINE COMPARTMENT HOOD.

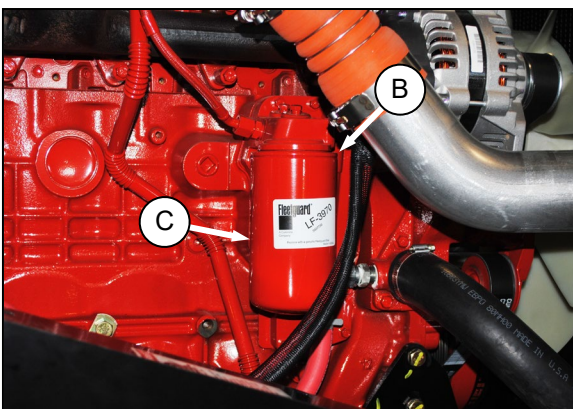

- Clean around the filter head (B).
- Remove filter (C).
- Clean gasket mating surface.
- Apply a thin film of clean oil to the gasket on the new filter.

- Screw the new filter onto the filter mount until the gasket contacts the filter head.
- Tighten the filter an additional $\frac{1}{2}$ to $\frac{3}{4}$ turn by hand.

IMPORTANT

Do not use a filter wrench to install the oil filter. Over-tightening can damage the gasket and filter.

- Install the oil pan drain plug (A).

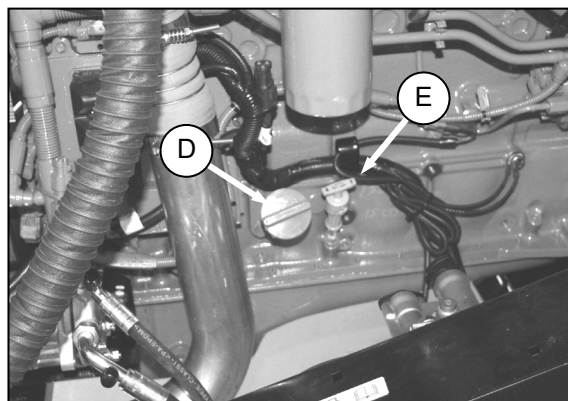

- Remove oil filler pipe cap (D) and add engine oil. The engine requires 20 U.S. quarts (21 litres) of SAE 15W40 Compliant with SAE Specs for API Class SJ and CH-4 Engine Oil.
- Replace filler cap (D).
- Operate the engine at low idle and check for leaks at the filter and drain plug.
- Stop the engine, wait 5 minutes and check the oil level with dipstick (E). Add or remove oil to bring oil to HIGH level mark on dipstick.
- Close engine compartment hood.
- Properly dispose of used oil and filter.

MAINTENANCE/SERVICE

7.8.5 AIR INTAKE SYSTEM

IMPORTANT

Do not run engine with air cleaner disconnected or disassembled.

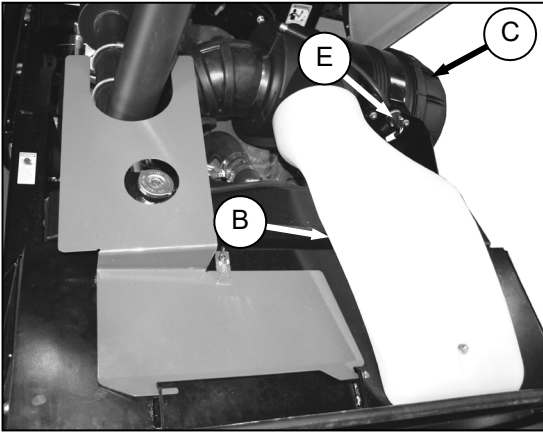
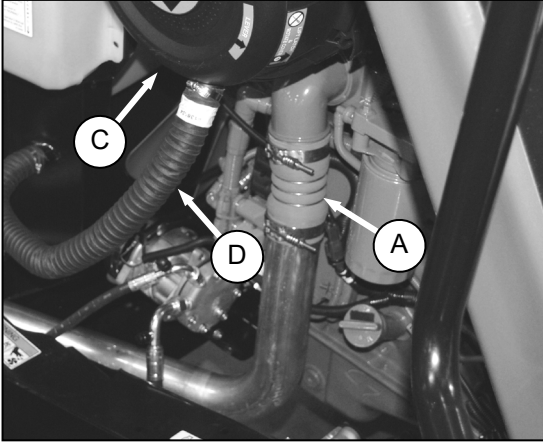

Engine intake air (A) is drawn through a duct (B) from the cooling box that pre-cleans the air, and then through a dual element filter (C). The air cleaner canister is equipped with aspirator (D) that removes dust continuously from the air cleaner housing. The air cleaner is also equipped with a restriction switch (E) which activates a warning light on the CDM with an alarm when the primary filter element requires cleaning.

NOTE

The warning light could activate when operating in extremely dirty conditions, in which case the filter element should be cleaned. Under normal operating conditions, filter servicing should be performed at the specified interval. Refer to Section 7.13, MAINTENANCE SCHEDULE.

7.8.5.1 Air Filter Servicing

DANGER

Stop engine and remove key from ignition before leaving operator's seat for any reason. A child or even a pet could engage an idling machine.

- Open engine compartment hood to highest position. See Section 7.4 ENGINE COMPARTMENT HOOD.

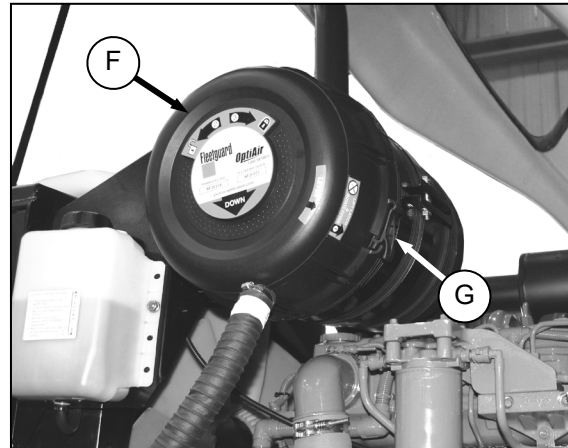

- Slightly lift catch (G) at side of end cap (F) and rotate end cap counterclockwise until it stops and arrow (H) lines up with unlock symbol on end cap.

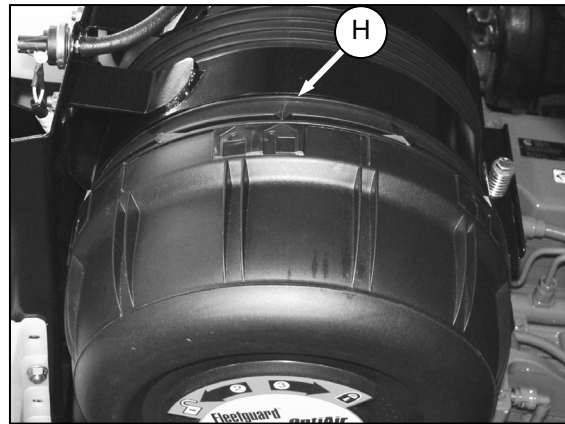

- Pull off the end cap.

(continued next page)

MAINTENANCE/SERVICE

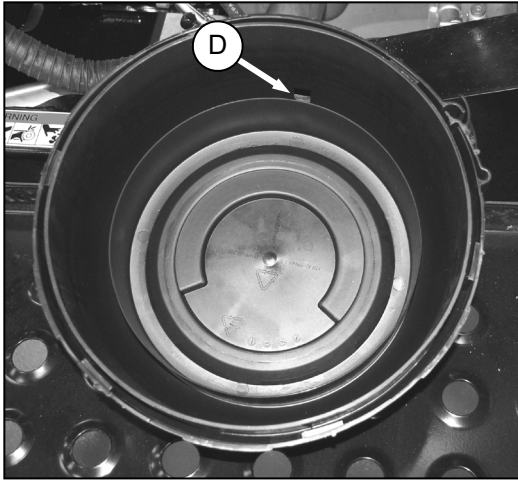

- d. Check the vacuator duct (D) daily for obstructions or damage. Clean or replace if necessary.

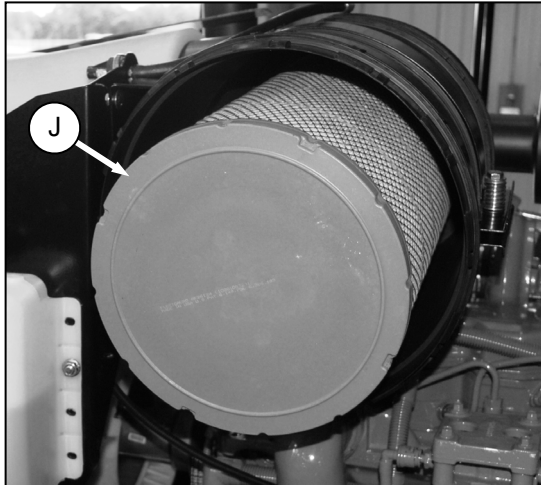

- e. Pull out the primary filter element (J).

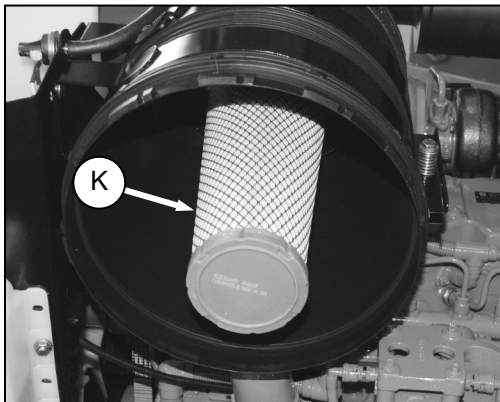

IMPORTANT

Do not remove the secondary filter element (K) unless it needs replacing. Do not attempt to clean the secondary (inner) element.

- f. Inspect as follows:
1. Hold a bright light inside element and check carefully for holes. Discard any element which shows the slightest hole.
 2. Be sure outer screen is not dented. Vibration would quickly wear a hole in the filter.
 3. Be sure filter gasket is in good condition. If gasket is damaged or missing, replace element.
 4. If element is coated with oil or soot, replace the element.
- g. Inspect the air intake piping for damage, cracked hoses, loose clamps, etc. Repair or replace damaged parts and tighten loose clamps.

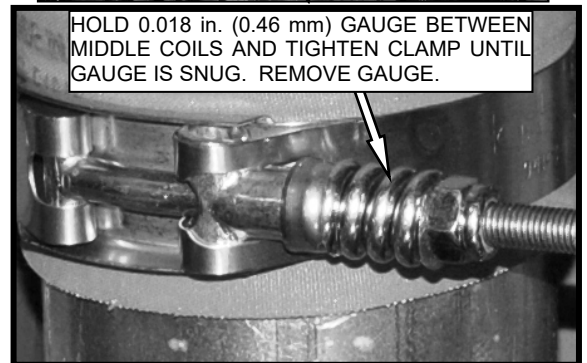
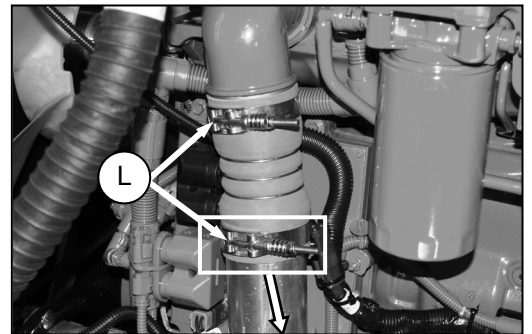
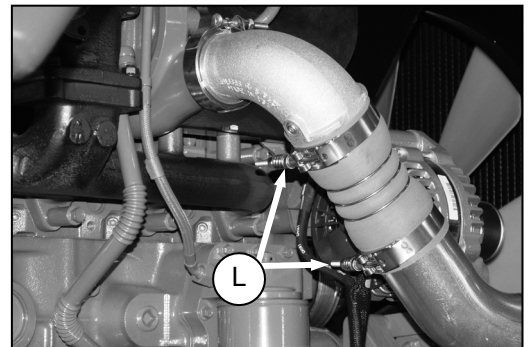

- h. If spring type clamps (L) require tightening use a gauge as shown.

MAINTENANCE/SERVICE

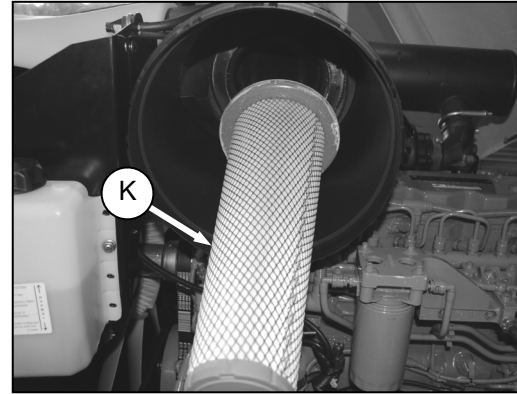
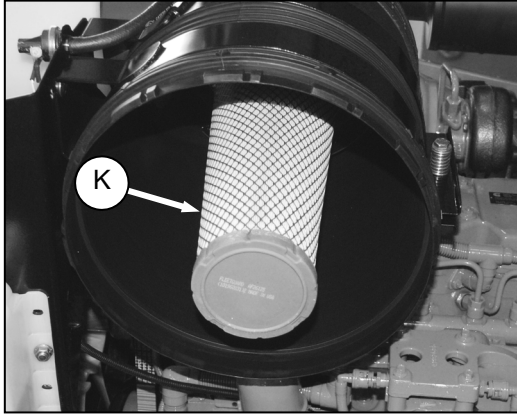

- i. Check the secondary element (K) for cleanliness. If there is visible dirt on the secondary element, replace both primary and secondary elements.

IMPORTANT

The air cleaner's primary (outer) filter element should be replaced after six cleanings or at least every three years.

IMPORTANT

The secondary (inner) element should be replaced every third time the primary element is changed.

- j. Clean inside of canister and cover with a damp cloth.

IMPORTANT

Leave secondary element in place to prevent ingress of dirt into engine intake.

- k. Pat sides of primary element gently to loosen dirt. Do not tap element against a hard surface.
- l. Using a Dry Element Cleaner Gun, clean element with compressed air.
- m. Hold nozzle next to inner surface, and move up and down pleats.

IMPORTANT

Air pressure must not exceed 60 psi (420 kPa). Do not direct air against outside of element, as dirt might be forced through to inside.

- n. Repeat steps h. and i. to remove additional dirt.
- o. Repeat inspection before installing.

- p. To remove the secondary element (K), pull it out of the canister.
- q. Insert secondary filter element (K) into canister, seal first, and push until seal is seated inside canister.

IMPORTANT

When replacing secondary filter, reinsert new filter as soon as possible to prevent dirt entering engine intake

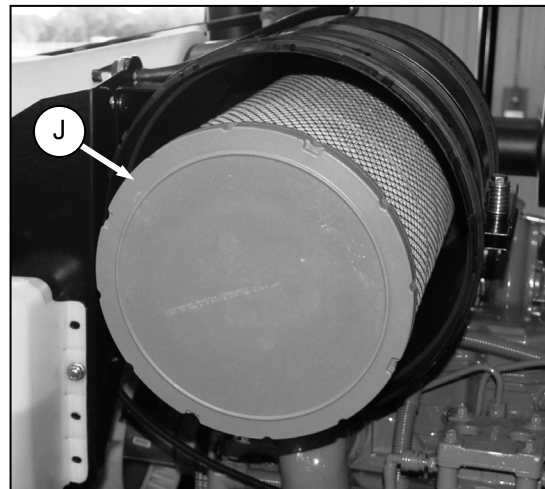

- r. Insert primary filter element (J) into canister over secondary element and push into place, ensuring that element is firmly seated in canister.

MAINTENANCE/SERVICE

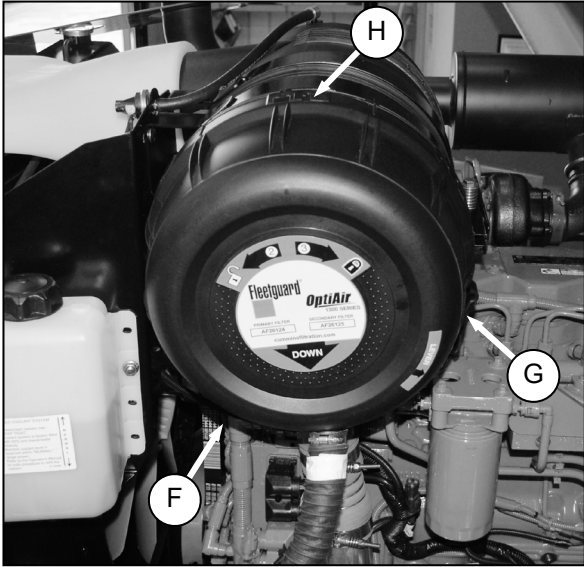

- s. Position end cap (F) onto filter housing with aspirator pointing approximately down.
- t. Align arrow (H) to unlock position on end cap and push end cap fully onto housing.
- u. Rotate end cap clockwise until catch (G) engages housing to prevent end cap from turning.
- v. Close engine compartment hood.

7.8.5.2 Charge Air Cooling

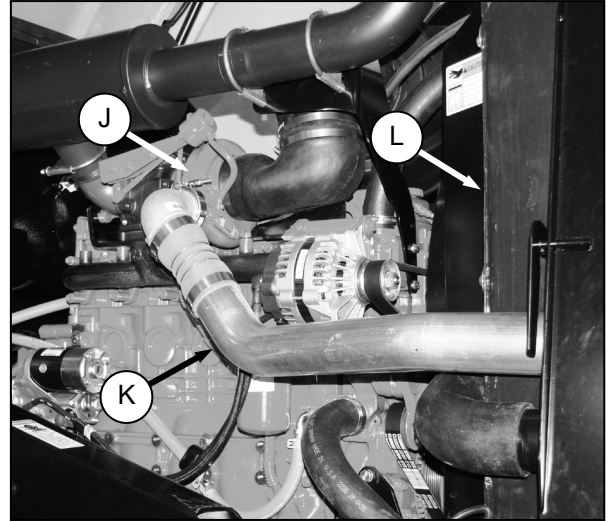

After the intake air passes through the air filter, it passes through the turbocharger (J) which boosts the pressure. This process heats the air so it is passed through pipe (K) to a cooler before entering the engine intake. The cooler is located in the cooling box (L) behind the radiator and should be cleaned daily with compressed air. Refer to Section 7.9.3, Cooling Box Maintenance.

MAINTENANCE/SERVICE

7.8.6 FUEL SYSTEM

7.8.6.2 Fuel Filters

7.8.6.1 Fuel Tank Venting

The fuel tank is vented by a hose that is connected to the filler tube. The hose is connected to a filter that should be changed annually. Change the filter as follows:



DANGER

Stop engine and remove key from ignition before leaving operator's seat for any reason. A child or even a pet could engage an idling machine.



WARNING

To avoid personal injury or death from explosion or fire, do not smoke or allow flame or sparks near windrower when servicing.

- Open engine compartment hood to highest position. See Section 7.4 ENGINE COMPARTMENT HOOD.

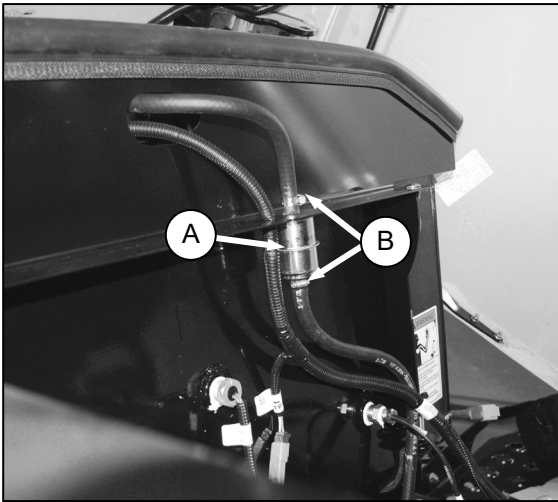

- Locate filter (A) on vent line against hydraulic oil reservoir.
- Release hose tension clamps (B) and slide away from filter. Pull hoses off filter.
- Position new filter through hole in frame and attach top hose onto filter. "IN" marking should face down.

NOTE

If filter has an arrow instead of an IN marking, arrow should point up.

- Attach lower hose to filter and secure both hoses with tension clamps (B).

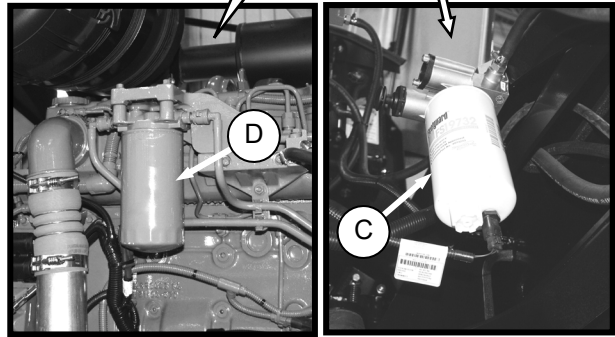
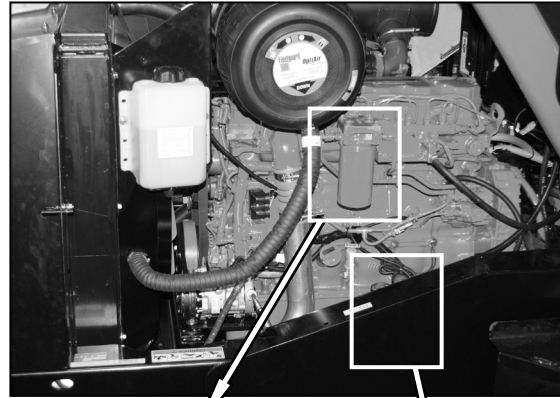

The M205 windrower fuel system is equipped with primary (C) and secondary (D) screw-on cartridge type filters. The primary (C) filter is equipped with a separator that separates sediment and water from the fuel. Change both filters as follows every 500 hours of operation:

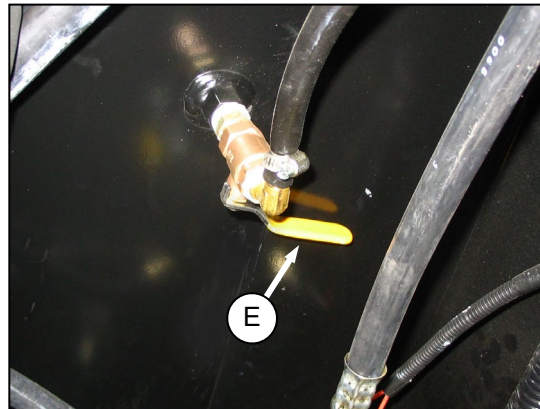

- Close fuel supply valve (E) under fuel tank.

(continued next page)

MAINTENANCE/SERVICE

b. Change primary filter (C) as follows:

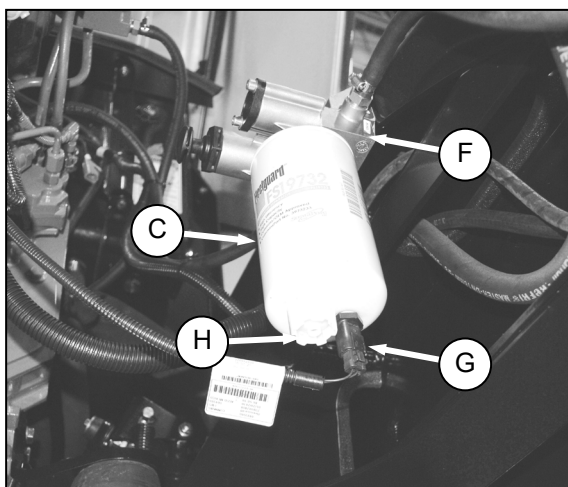

1. Clean around the filter head (F).
2. Disconnect Water In Fuel (WIF) sensor (G) from bottom of filter.
3. Turn drain valve (H) by hand counterclockwise until draining occurs and drain filter into a container.
4. Remove filter (C) with a filter wrench.
5. Clean gasket mating surface.

IMPORTANT

Do not pre-fill filter with fuel. Pre-filling can contaminate the fuel system.

6. Screw the new filter (C) onto the filter mount until the gasket contacts the filter head.
7. Reconnect WIF sensor (G).
8. Tighten the filter an additional $\frac{1}{2}$ to $\frac{3}{4}$ turn by hand.

IMPORTANT

Do not use a filter wrench to install the filter. Over-tightening can damage the gasket and filter.

c. Change secondary filter (D) as follows:

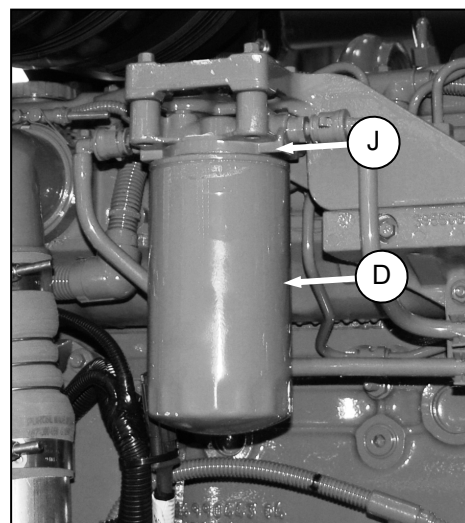

1. Clean around the filter head (J).
2. Place a container under the filter to catch split fluid.
3. Remove filter (D) with a filter wrench.
4. Clean gasket mating surface.

IMPORTANT

Do not pre-fill filter with fuel. Pre-filling can contaminate the fuel system.

5. Screw the new filter onto the filter mount until the gasket contacts the filter head.
6. Tighten the filter an additional $\frac{1}{2}$ to $\frac{3}{4}$ turn by hand.

IMPORTANT

Do not use a filter wrench to install the filter. Over-tightening can damage the gasket and filter.

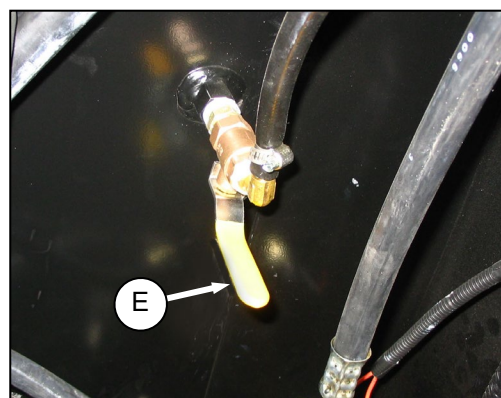

- d. Open fuel valve (E) under fuel tank.
- e. Prime the system. Refer to Section 7.8.6.5 System Priming.
- f. Close engine compartment hood.

MAINTENANCE/SERVICE

7.8.6.3 Draining Fuel Tank

Draining the fuel tank is necessary to remove old or contaminated fuel.



DANGER

Stop engine and remove key from ignition before leaving operator's seat for any reason. A child or even a pet could engage an idling machine.



WARNING

To avoid personal injury or death from explosion or fire, do not smoke or allow flame or sparks near windrower when servicing.

- Stop the engine and remove the key.
- Open engine compartment hood to lowest position. See Section 7.4 ENGINE COMPARTMENT HOOD.

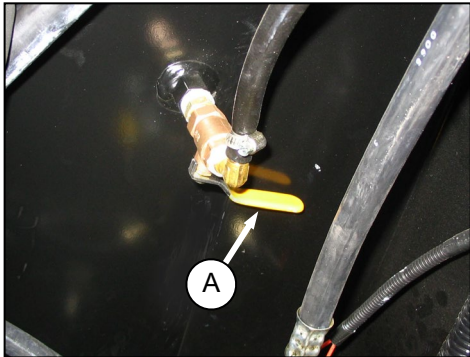

- Close fuel supply valve (A).
- Place a 5 U.S. gallon (20 litre) drain pan under the fuel supply hose (B) at primary filter.

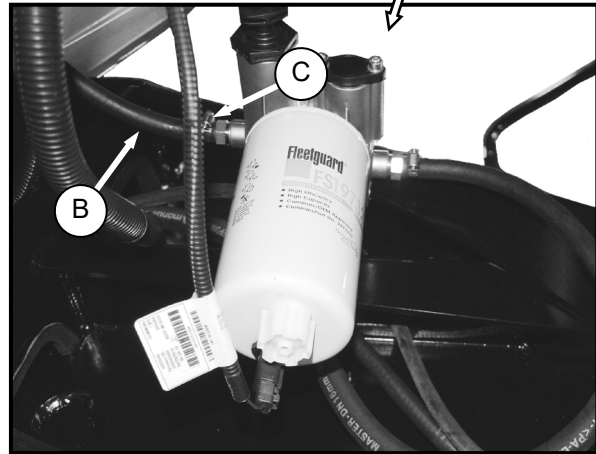
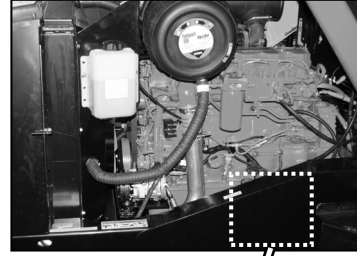

- Loosen clamp (C) and pull hose (B) off fitting.
- Route hose to drain pan and open valve (A) to drain tank.

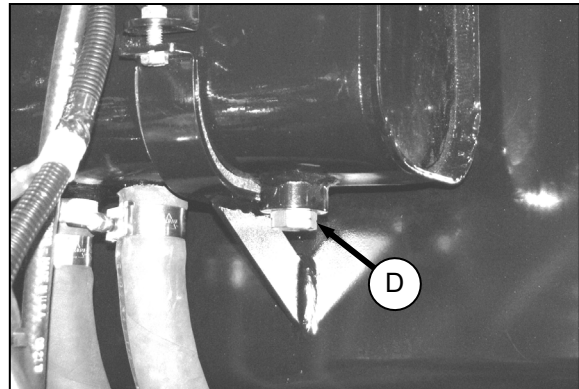

- After fuel has stopped flowing from hose, remove plug (D) to ensure tank is completely drained.
- Add some clean fuel to tank to flush out any remaining contaminants.
- Replace drain plug and reattach hose (B) to fitting. Install clamp (C) and tighten.
- Refill tank.

MAINTENANCE/SERVICE

7.8.6.4 Separator

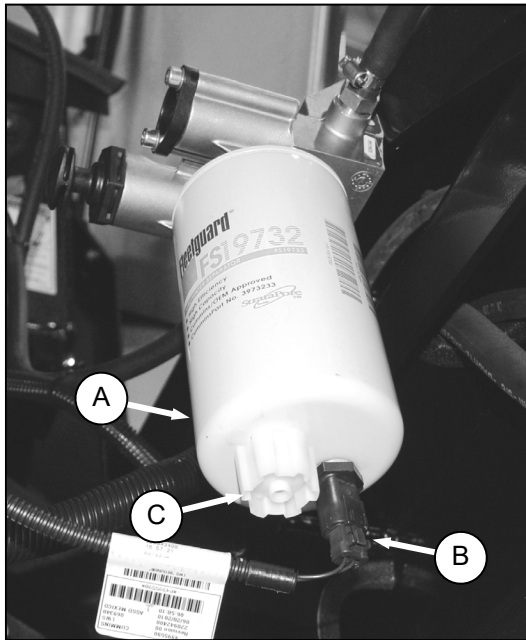

A fuel water separator is incorporated into the primary fuel filter (A). The separator is equipped with a sensor (B) that detects water in the fuel and alerts the operator on the CDM, and a drain (C).

Drain the water and sediment as follows from the separator daily or at any time the CDM Water in Fuel (WIF) light illuminates.

- Stop engine and remove key.
- Place a container under the filter to catch spilt fluid.
- Turn drain valve (C) by hand $1\frac{1}{2}$ to 2 turns counterclockwise until draining occurs.
- Drain the filter sump of water and sediment until clear fuel is visible.
- Turn the valve clockwise to close the drain.
- Dispose of fluid safely.

7.8.6.5 System Priming

Controlled venting of air is provided at the injection pump through the fuel drain manifold. Small amounts of air introduced by changing filters or injection pump supply line will be vented automatically, if the fuel filters are changed in accordance with instructions.



WARNING

The fuel pump high-pressure fuel lines and fuel rail contain extremely high pressure fuel. Never loosen any fittings. Personal injury and property damage can result.

IMPORTANT

Bleeding the fuel system is not recommended nor required.

Manual priming will be required if:

- The fuel filter is replaced.
- Injection pump is replaced.
- High-pressure fuel lines are replaced.
- Engine is run until fuel tank is empty.

Prime the fuel system as follows:

- Stop the engine and remove the key.
- Open engine compartment hood to lowest position. See Section 7.4 ENGINE COMPARTMENT HOOD.

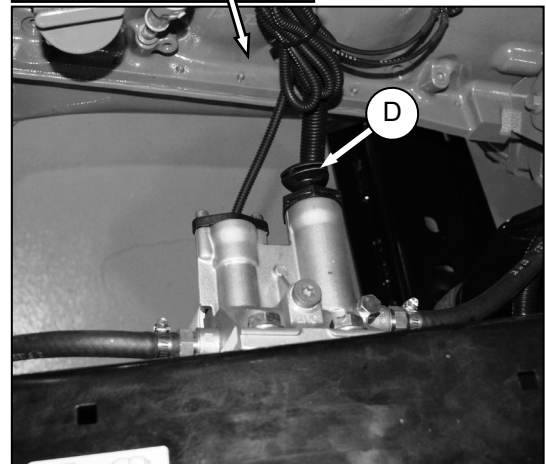
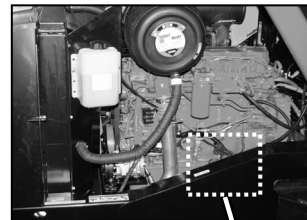

- Turn the priming knob (D) counterclockwise to unlock the plunger on the primary filter head.
- Pump approximately 120 times to pressurize the fuel system.
- Lock the plunger by turning knob (D) clockwise until snug.
- Try starting engine. If engine does not start, repeat priming.

MAINTENANCE/SERVICE

7.8.7 ENGINE COOLING SYSTEM

The engine cooling system is designed to maintain the engine operating temperature within the specified operating range.

NOTE

Anti-freeze is essential in any climate. It broadens the operating temperature range by lowering the coolant freezing point and by raising its boiling point. Anti-freeze also contains rust inhibitors and other additives to prolong engine life.

IMPORTANT

If anti-freeze strength is not adequate, do not drain cooling system to protect against freezing. System may not drain completely, and damage from freezing could still result.

To service the cooling system, perform the following:



DANGER

Stop engine and remove key from ignition before leaving operator's seat for any reason. A child or even a pet could engage an idling machine.

- Stop engine and remove key.

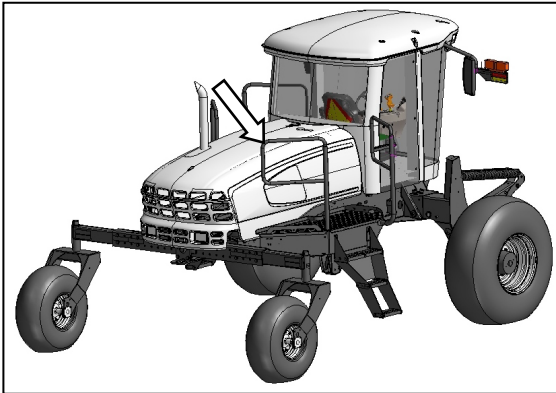

- Move the right cab-forward platform to the open position for access to the coolant tank and radiator. Ensure the platform latch is engaged in open position.
- Raise engine compartment hood to lowest position. See Section 7.4 ENGINE COMPARTMENT HOOD.

7.8.7.1 Coolant Level and Concentration

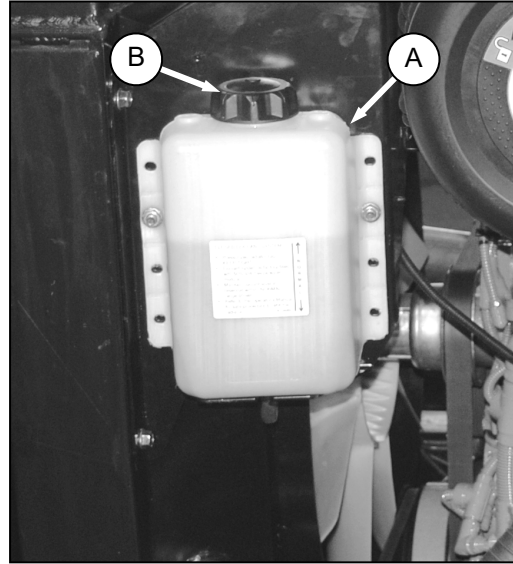

- Check daily the coolant level in the coolant recovery tank (A). Tank should be at least half full.
- If less, then remove cap (B) and add coolant. Use Ethylene Glycol with SCA equal parts with high quality, soft, de-ionized or distilled water as recommended by the supplier to protect the engine to temperatures of -30°F (-34°C).

NOTE

Do not add coolant to radiator except when changing coolant.

- Replace cap (B).

MAINTENANCE/SERVICE

7.8.7.2 Radiator Cap



WARNING

- To avoid personal injury from hot coolant, do not turn radiator cap until engine has cooled.
- Engine exhaust may be hot.

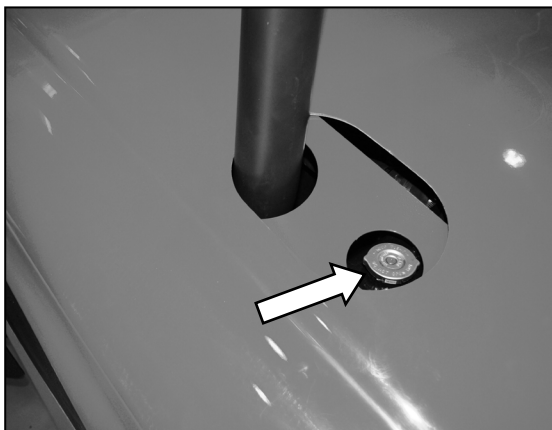

- a. Remove the radiator cap and check as follows:
 1. The radiator cap must fit tightly.

NOTE

Cap gasket must be in good condition to maintain the 14-18 psi (97-124 kPa) pressure in the cooling system. To check the cap, proceed as follows:

2. Turn the cap counterclockwise to the first notch to relieve pressure before removing cap completely.
 3. Turn the cap again and remove.
 4. Check the gasket for cracks or deterioration and replace the cap if necessary.
 5. Check that the spring in the cap moves freely.
 6. Check the anti-freeze in the radiator with a tester annually, preferably before off-season storage. Tester should indicate protection to temperatures of -30°F (-34°C).
- b. Replace the cap if spring is stuck.
 - c. Close engine compartment hood and move maintenance platform to working position.

7.8.7.3 Changing Coolant

Coolant should be drained, and the system flushed and filled with new coolant every 2000 hours or 2 years. Change coolant, and flush the system as follows:



CAUTION

To avoid personal injury from hot coolant, do not turn radiator cap until engine cools.



DANGER

Stop engine and remove key from ignition before leaving operator's seat for any reason. A child or even a pet could engage an idling machine.

- a. Stop engine and let it cool.

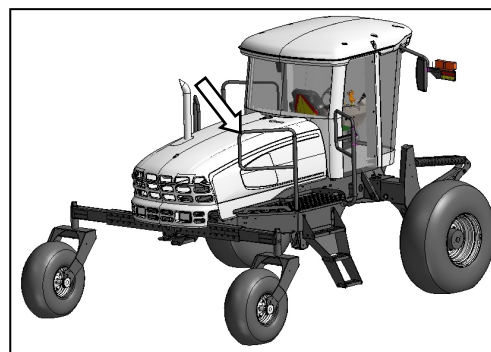

- b. Move the right cab-forward platform toward the rear of the windrower. Ensure the lock is engaged.
- c. Raise engine compartment hood to lowest position. See Section 7.4 ENGINE COMPARTMENT HOOD.

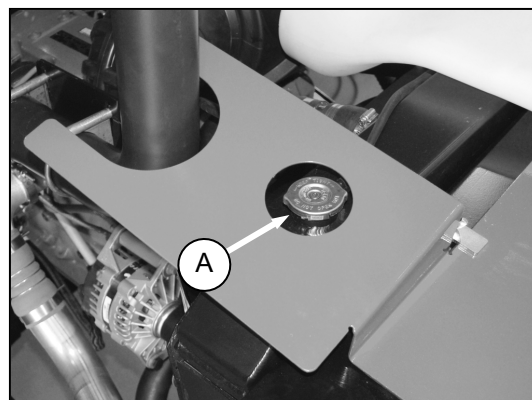

- d. Turn the radiator cap (A) to the first notch to relieve pressure before removing cap completely.

(continued next page)

MAINTENANCE/SERVICE

- e. Place a drain pan (about 8 U.S. gallons (30 litres)) under the engine and radiator.

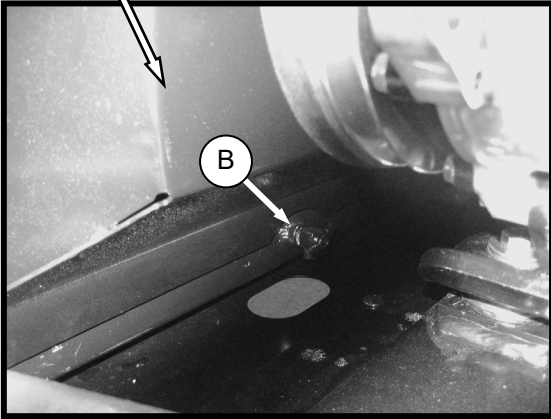
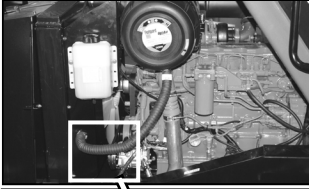

- f. Remove the radiator cap and open radiator drain valve (B) on the engine side of the radiator lower tank. Use a deflector or a hose to prevent coolant running onto frame.

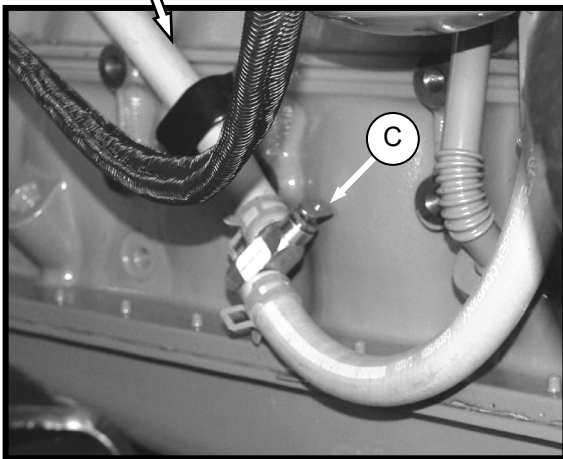

- g. Close the heater shut-off valve (C), and disconnect hose on heater side of valve.
h. Open valve to drain the block.

- i. When system is drained, replace hose on valve (C) and close radiator drain valve (B).
j. Fill system with clean water through the radiator and replace radiator cap.
k. Open heater shut-off valve (C).
l. Start engine and turn temperature control knob to high. Run engine until normal operating temperature is reached.
m. Stop engine and drain water out before rust or sediment settles. See steps d. to h.
n. Close drain valves and fill system with a solution of clean water and a heavy duty radiator cleaner. Follow instructions provided with cleaner.
o. After using cleaner solution, again flush system with clean water. Inspect radiator, hoses and fittings for leaks.
p. Close drain valves and fill system through radiator. Use Ethylene Glycol with SCA equal parts with high quality, soft, de-ionized or distilled water as recommended by the supplier. System capacity is 5.3 U.S. Gallons (20 litres).
q. Close radiator cap tightly.

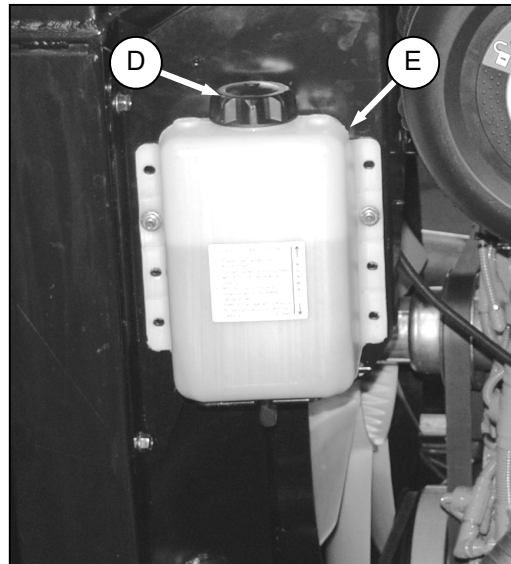

- r. Remove cap (D) from recovery tank (E) and add coolant until half full.
s. Move maintenance platform to working position and close engine compartment hood.

MAINTENANCE/SERVICE

7.8.8 GEARBOX

7.8.8.1 Lubricant Level



CAUTION

Park on a flat, level surface, header on the ground and the ground speed lever in N-DETENT position.



DANGER

Stop engine and remove key from ignition before leaving operator's seat for any reason. A child or even a pet could engage an idling machine.

- a. Check the lubricant level every 50 hours as follows:
 1. Park the windrower on level ground, shutdown the engine, and remove the key.

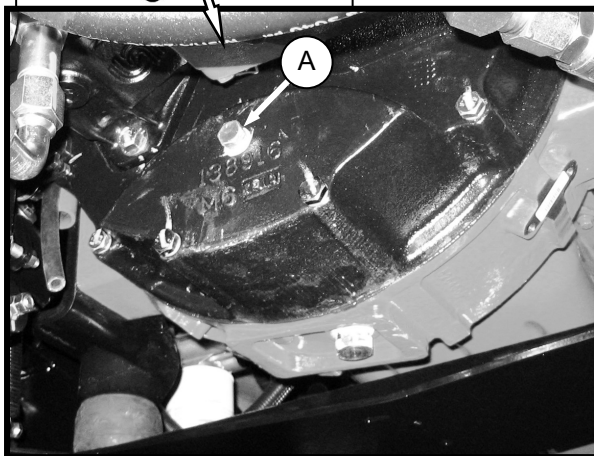
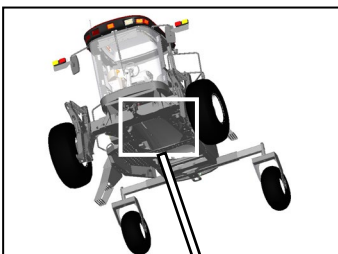

2. Remove plug (A). The lubricant should be visible through the hole or slightly running out.

- b. Add lubricant as follows:

1. Raise engine compartment hood to highest position. See Section 7.4 ENGINE COMPARTMENT HOOD.

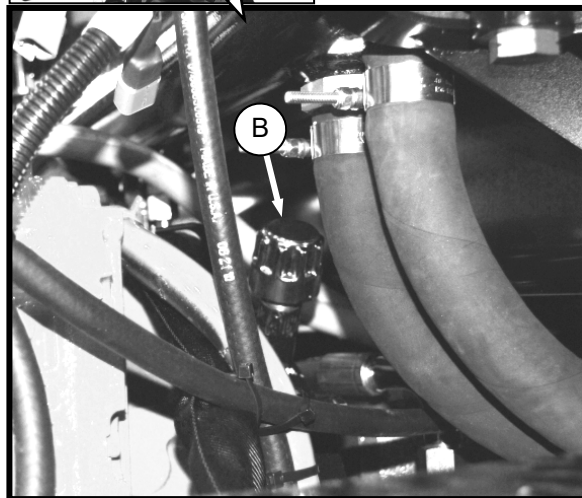
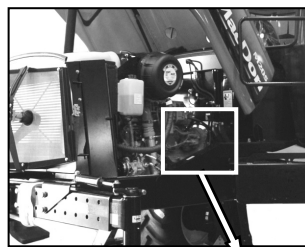

2. Remove breather cap (B), and add lubricant until it runs out at (A). Use SAE 75W-90 API Service Class GL-5, Fully Synthetic Transmission Lubricant. SAE J2360 preferred.
3. Replace plug and breather cap, and tighten.

MAINTENANCE/SERVICE

7.8.8.2 Changing Lubricant

Change gearbox lubricant after the first 50 hours and then at 500 hours as follows:

NOTE

The engine should be warm prior to changing the oil.

- Stop the engine and remove the key.
- Place a 1 U.S. gallon (4 litres) drain pan under the gearbox.

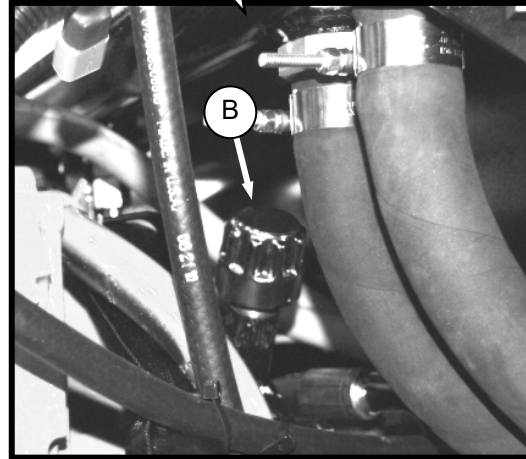
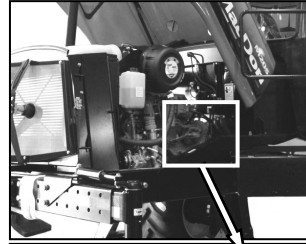
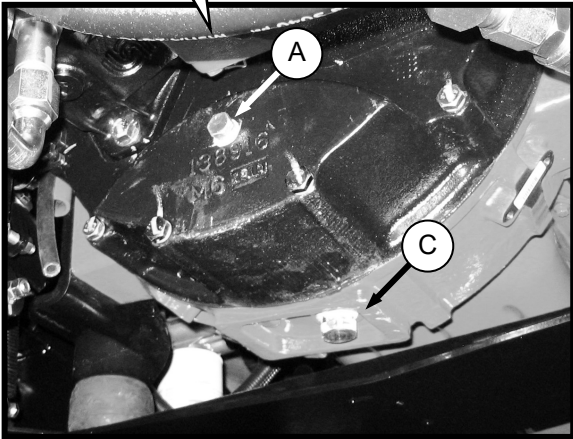
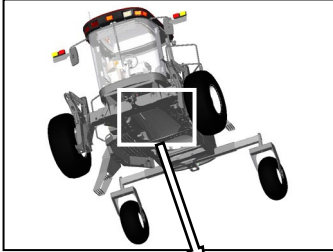

- Remove drain plug (C) and allow the oil to completely finish draining.
- Install the drain plug (C) and remove the check plug (A).

- Unscrew breather cap (B) and add lubricant. The gearbox will require 2.2 U.S. quarts (2.1 litres). Add sufficient lubricant until it slightly runs out of hole (A). Use SAE 75W-90 API Service Class GL-5, Fully Synthetic Transmission Lubricant. SAEJ2360 preferred.
- Install plugs (A) and (C).
- Operate the engine at low idle and check for leaks at the check plug and drain plug.

7.8.9 EXHAUST SYSTEM



CAUTION

To avoid burns, do not touch muffler when engine is running or before allowing sufficient cooling time after shut-down

The exhaust system requires no regular maintenance but it should be inspected periodically as follows:

- a. Open engine compartment hood to highest position. See Section 7.4 ENGINE COMPARTMENT HOOD.

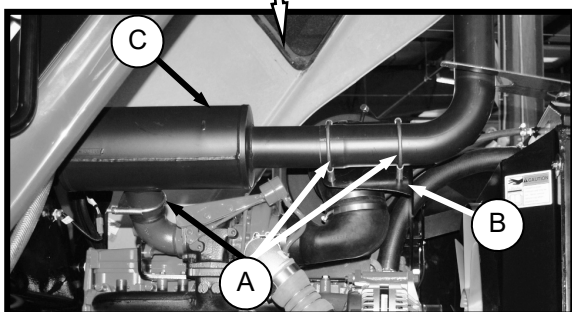
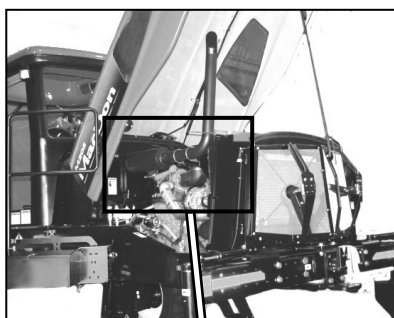

- b. Inspect the area around clamps (A) for breakage, cracks and rust-through. In addition to excess noise, a leaky exhaust system may allow exhaust gases to escape to the cab.
- c. Dents or crushed portions of any tubing create exhaust flow restriction and increase back pressure significantly. Even relatively small dents will cause decreased fuel economy and increased turbo wear. If dents are relatively large, increased bearing and cylinder wear will occur due to increased exhaust temperature.
- d. The exhaust system should be secured to eliminate vibration. The brackets (B) should fit securely to the muffler (C) and to the engine.
- e. Do not change muffler type, piping sizes or exhaust configuration; these have all been selected for some very specific, technical reasons by the engineer. See your dealer for proper replacement parts.

MAINTENANCE/SERVICE

7.8.10 BELTS



DANGER

Stop engine and remove key from ignition before leaving operator's seat for any reason. A child or even a pet could engage an idling machine.

7.8.10.1 Tension

- The alternator, water pump, and fan belt are automatically tightened and manual adjustment is not required.
- Tension A/C compressor belt (A) as follows:

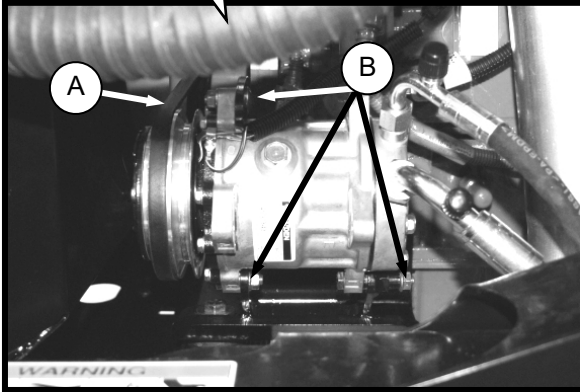
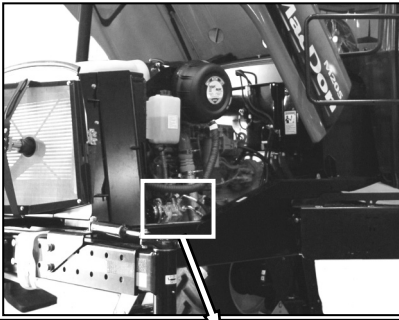

- Shutdown engine and open engine compartment access hood to lowest position. See Section 7.4 ENGINE COMPARTMENT HOOD.
- Loosen compressor mounting hardware (B).
- Pry compressor away from engine so that a force of 8 to 12 lbf (35-55 N) deflects the belt (A) 3/16 inch (5 mm) at mid-span.
- Tighten compressor mounting hardware.
- Recheck tension and re-adjust as required.

7.8.10.2 A/C Compressor Belt Replacement

- Shutdown the engine and open engine compartment access hood to lowest level. Refer to illustration opposite.
- Loosen compressor mounting hardware (B) and push compressor towards engine to release tension.
- Remove belt (A).
- Install new belt (A) on pulleys.
- Pry compressor away from engine so that a force of 8 to 12 lbf (35-55 N) deflects the belt (A) 3/16 inch (5 mm) at mid-span.
- Tighten compressor mounting hardware (B).
- Recheck tension and re-adjust as required.

7.8.10.3 Fan Belt Replacement

DANGER

Stop engine and remove key from ignition before leaving operator's seat for any reason. A child or even a pet could engage an idling machine.

- Shutdown the engine and open engine compartment access hood to highest position.

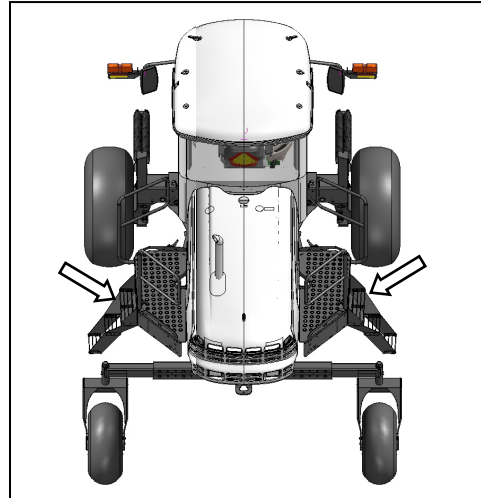

- Move both maintenance platforms to rear (cab-forward) of windrower.

(continued next page)

MAINTENANCE/SERVICE

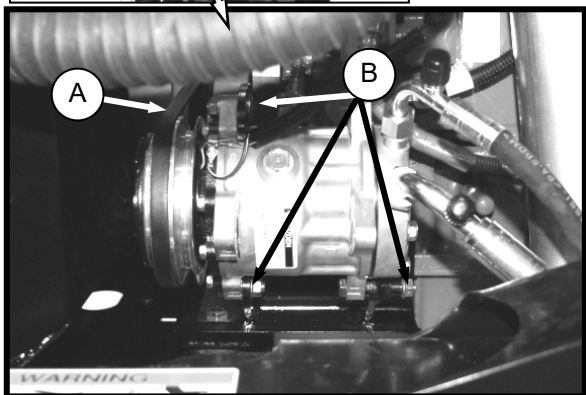
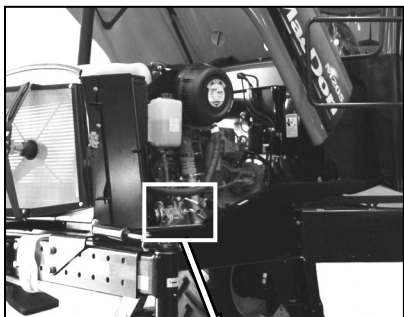

- c. Loosen compressor mounting hardware (B) and push compressor towards engine to release belt (A) tension.
- d. Remove belt (A).

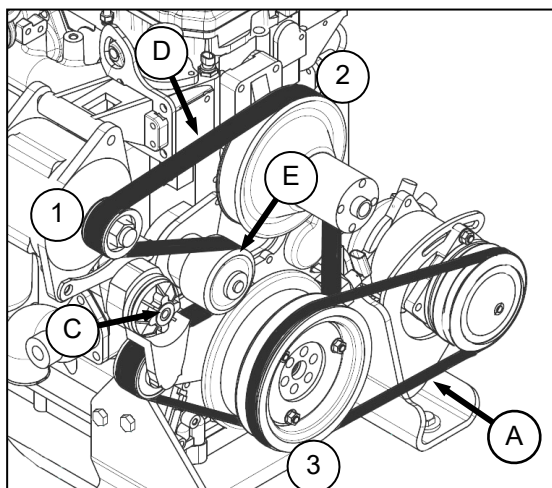

- e. Insert the drive end of a ½ inch drive ratchet wrench into the belt tensioner (C).
- f. Rotate tensioner counterclockwise until fan belt (D) can be slipped off pulley (E). Release tensioner and remove wrench.

- g. Remove belt in order 1-2-3 as shown. Route fan belt around fan and remove belt.
- h. Install new belt (D) around fan and onto pulleys in order 3-2-1.
- i. Insert the drive end of a ½ inch drive ratchet wrench into the belt tensioner (C).
- j. Rotate tensioner counterclockwise until belt (D) can be slipped onto pulley (E). Release tensioner and remove wrench.
- k. Check that belt is properly seated in all pulley grooves.
- l. Install A/C compressor belt (A) on pulleys.
- m. Pry compressor away from engine so that a force of 8 to 12 lbf (35-55 N) deflects the belt (A) 3/16 inch (5 mm) at mid-span.
- n. Tighten compressor mounting hardware (B).
- o. Recheck tension and re-adjust as required.
- p. Move maintenance platforms to working position and close engine compartment hood.

MAINTENANCE/SERVICE

7.8.11 ENGINE SPEED

The maximum and idle engine speeds are factory set to the specifications. See Section 4.2 Specifications. If specified speeds cannot be maintained, see your Windrower dealer.

IMPORTANT

Do not remove any seals from injector pump; removal of seals will **void the engine warranty**.

7.8.11.1 Throttle Adjustment

The engine speed is controlled with the throttle lever that is connected to an electronic sensor inside the console. The throttle lever in the cab should move the throttle sensor the full range between slow speed stop and full RPM stop without contacting the console at either position. If the throttle lever is contacting the console and interferes with specified engine speeds, the sensor position possibly requires adjustment. See your Windrower dealer.

MAINTENANCE/SERVICE

7.9 COOLING BOX

7.9.1 COOLING BOX SCREEN

The cooling box screen is equipped with an automatic cleaning device which "vacuums" the screen by means of two rotors. They only operate when the engine is running. The rotors are electrically driven and the suction is provided by the engine cooling fan.

If the screen is not being cleaned by the rotors, they may be plugged. Service rotors and screen as follows:

- a. Stop engine and remove key.
- b. Raise engine compartment hood fully. See Section 7.4 ENGINE COMPARTMENT HOOD.

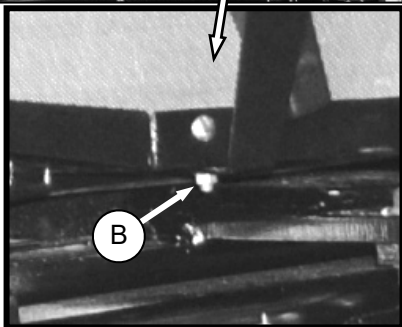
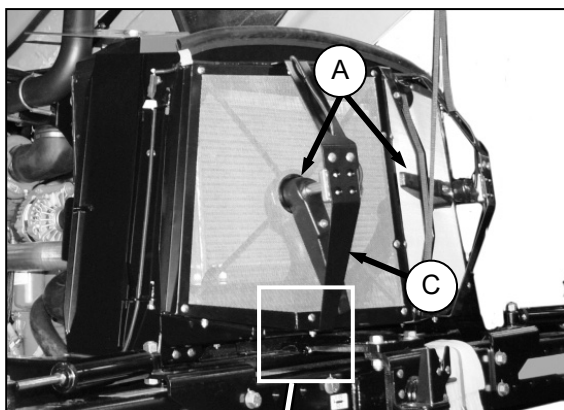

- c. If rotors (A) are plugged, clean as follows:
 1. Remove nut (B).

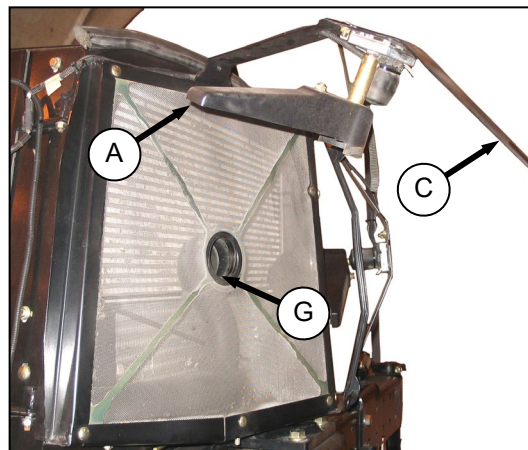

2. Pivot rotor assembly (C) away from screen.
3. Blow out debris from rotors (A) with compressed air.

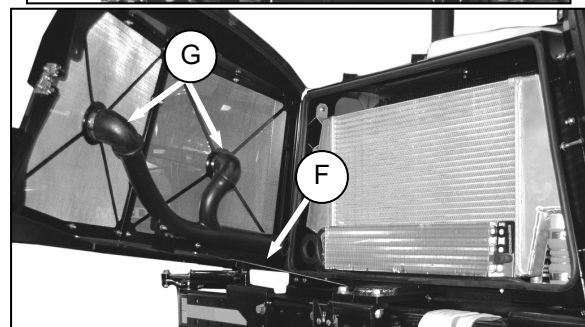
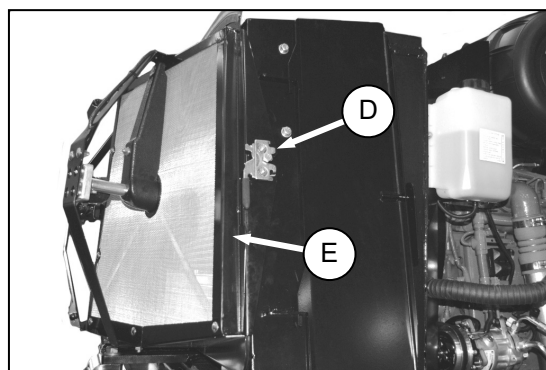

- d. Push latch (D) and open screen assembly access door (E). Secure with rod (F) stored inside screen door.
- e. If ducts (G) are plugged, blow out debris with compressed air.
- f. Clean screen with compressed air.
- g. Reposition rotor assembly (C) secure with bolt and nut (B).
- h. Close screen access door (E) and engage latch (D).

MAINTENANCE AND SERVICE

7.9.2 ROTOR TO SCREEN CLEARANCE

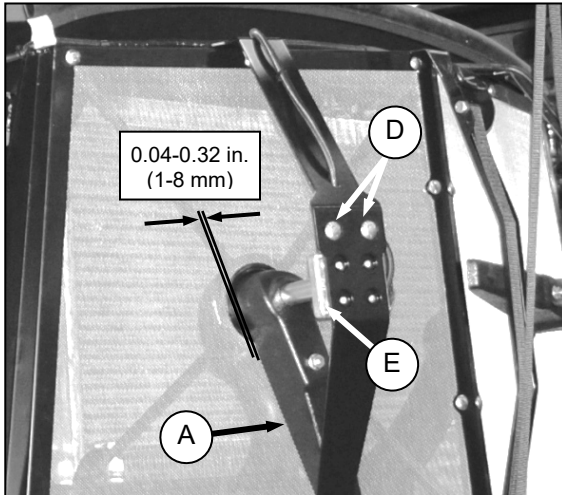

- a. Check clearance between trailing edge of rotor (A) and screen. It should be .04-.32 inches (1-8 mm) at all locations when rotating.

NOTE

Rotor may touch screen as long as it continues to rotate.

- b. If necessary, adjust clearance as follows:

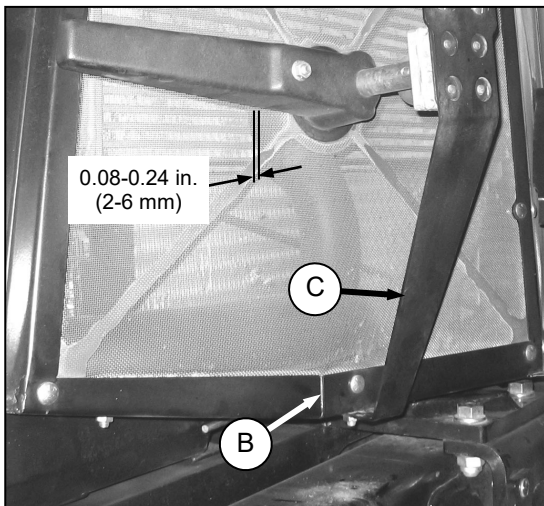

1. Loosen nut (B) on motor support (C).
2. Move support in or out until duct is 0.08-0.24 in. (2-6 mm) from screen near the center.
3. Re-tighten nut (B).
4. Loosen the two motor mount bolts (D).
5. Move motor/ duct assembly (E) to obtain 0.04-0.32 in. (1-8 mm) gap to screen at full rotation of the duct.
6. Re-tighten nuts (D) on motor mount.

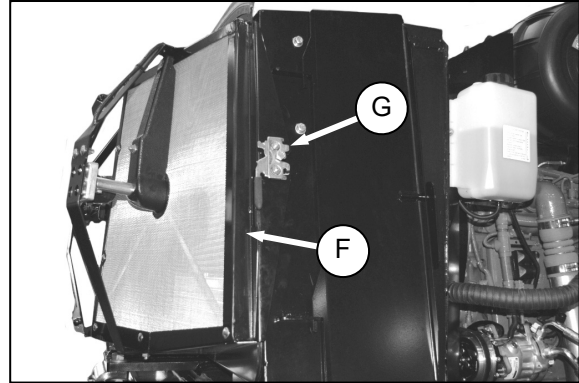

- c. Close screen access door (F) and engage latch (G).
- d. Lower engine compartment hood.

MAINTENANCE/SERVICE

7.9.3 COOLING BOX MAINTENANCE

The radiator and oil cooler should be cleaned daily with compressed air and more frequent cleaning may be necessary in severe conditions. The charge air cooler and air conditioning condenser may also be cleaned at the same time. To clean these components, refer to illustrations below and proceed as follows:



DANGER

Stop engine and remove key from ignition before leaving operator's seat for any reason. A child or even a pet could engage an idling machine.

- a. Stop engine and remove key.
- b. Raise engine compartment hood fully. See Section 7.4 ENGINE COMPARTMENT HOOD.

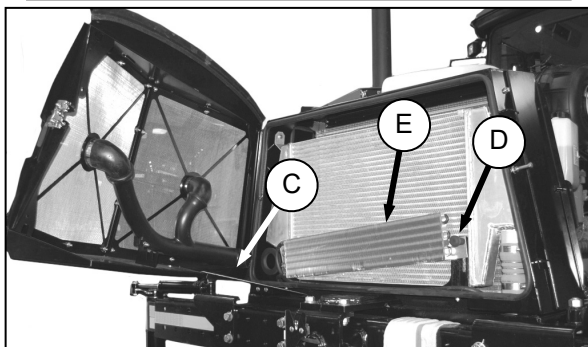
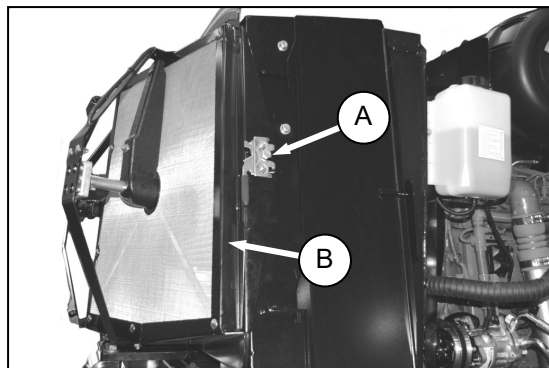

- c. Push latch (A) and open screen assembly access door (B). Secure with rod (C) stored inside the screen door.
- d. Turn knob (D) until loose and move end of fuel cooler (E) up in slot. Tighten knob to secure cooler.

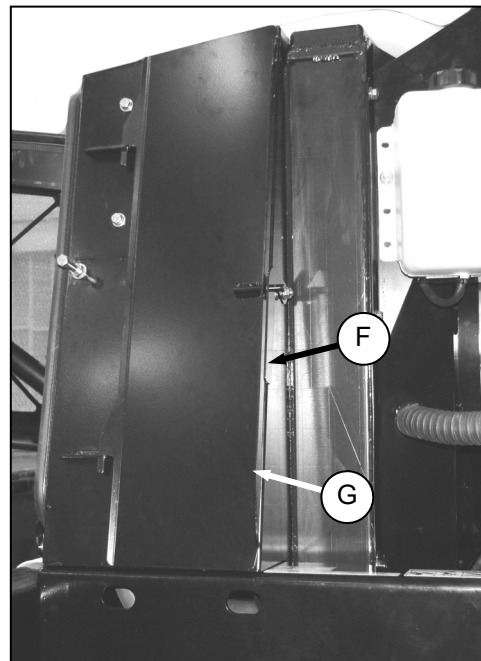

- e. Lift lever (F) and pull open access door (G).

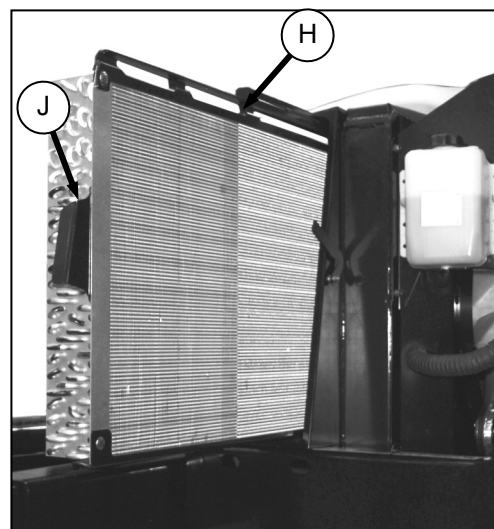

- f. Slide out the oil cooler/A/C condenser assembly (H) with handle (J).

(continued next page)

MAINTENANCE AND SERVICE

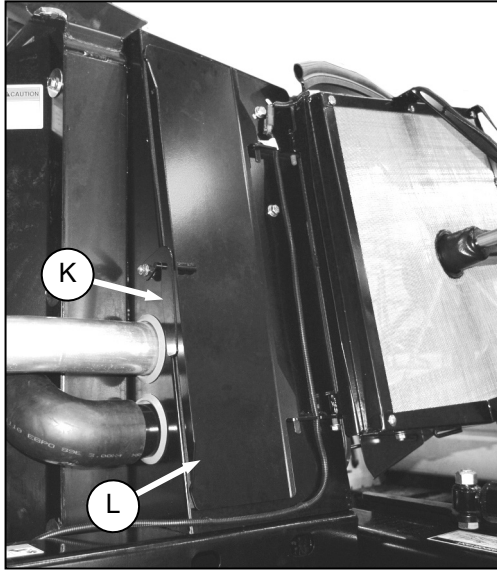

- g. Lift latch (K) and open access door (L) at left side of cooling box.

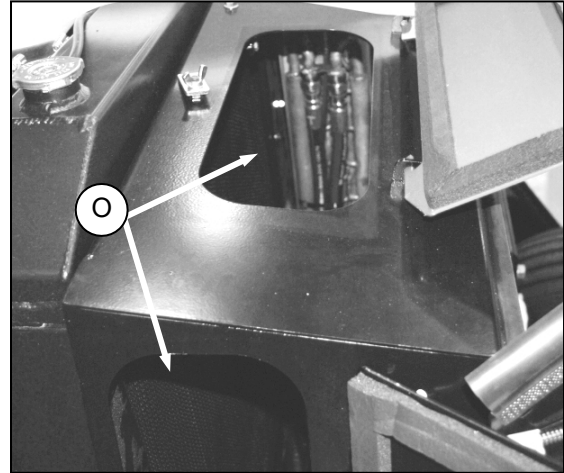

- i. Clean radiator (O) through access holes in cooling box with compressed air.

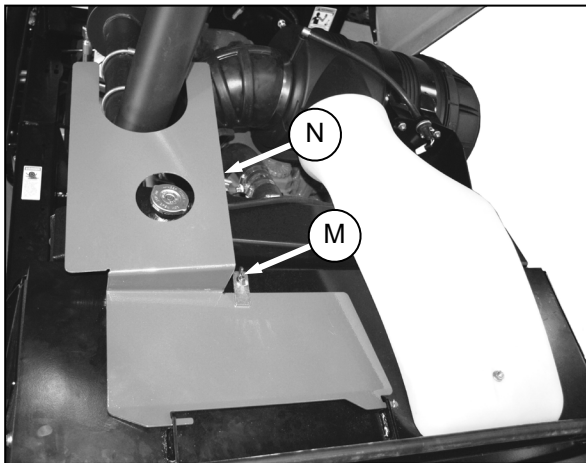

- h. Remove wing-nut (M), and open access door (N) at top of cooling box.

IMPORTANT

Fins on coolers can be very easily bent which may interfere with its function. Exercise caution when cleaning.

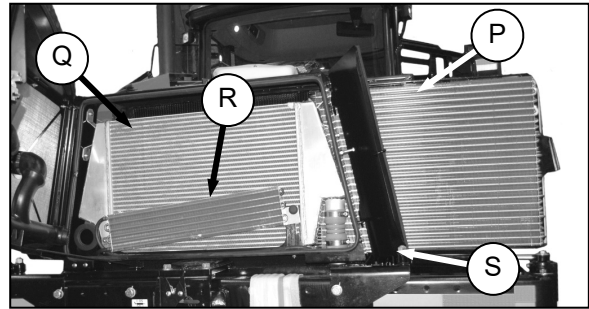

- j. Clean oil cooler/A/C condenser (P), charge air cooler (Q), fuel cooler (R), and cooling box (S) with compressed air.
- k. Inspect all lines and coolers for evidence of leaks and damage.

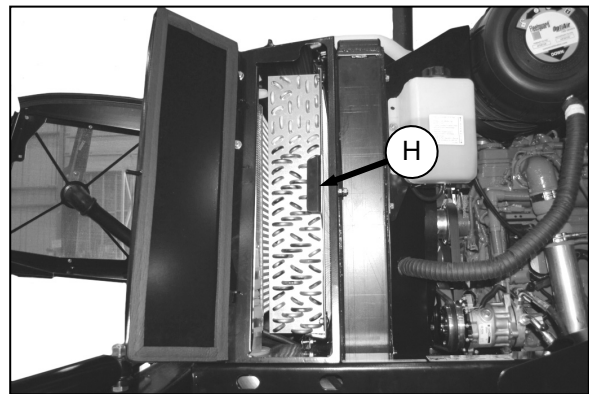

- l. Slide oil cooler (H) back into cooling box.

(continued next page)

MAINTENANCE/SERVICE

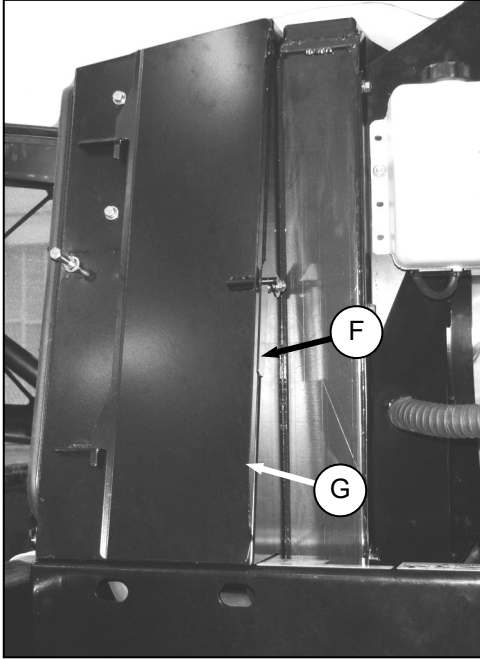

- m. Close side access door (G), and lock with lever (F).

- p. Unhook support rod (C) in screen door and store in screen door.

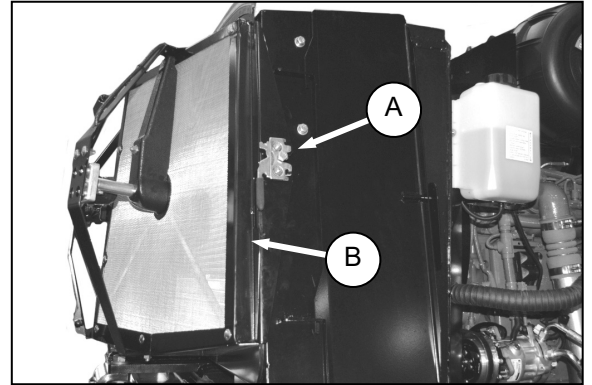

- q. Close screen door (B) until latch engages pin (A).
r. Lower hood and hood latch will lock hood.

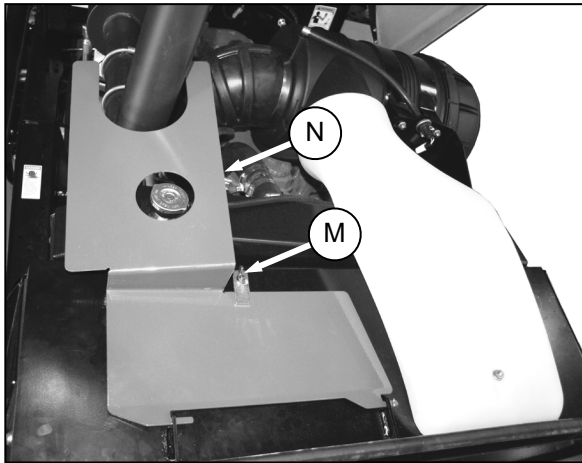

- n. Close top door (N), and secure with wing-nut (M).

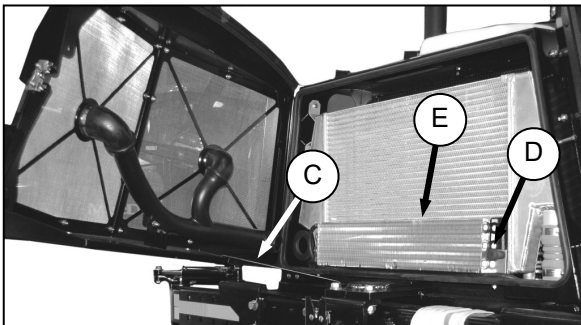

- o. Loosen knob (D) and lower fuel cooler (E) to original position. Tighten knob.

MAINTENANCE AND SERVICE

7.10 ELECTRICAL SYSTEM

Electrical schematics are attached at the back of this manual.

7.10.1 BATTERY



WARNING

- Gas given off by battery electrolyte is explosive. Keep all smoking materials, sparks and flames away from batteries.
- Follow proper charging and boosting procedures given in this section.
- Ventilate when charging in enclosed space.

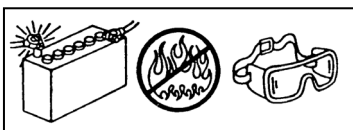

- Always wear protective eye-wear when working near batteries.
- Do not tip batteries more than 45° to avoid electrolyte loss.
- Battery electrolyte causes severe burns. Avoid contact with skin, eyes or clothing.
- Keep batteries out of reach of children.
- If electrolyte is spilled or splashed on clothing or the body, neutralize it immediately with a solution of baking soda and water, then rinse with clean water.
- Electrolyte splashed into the eyes is extremely dangerous. Should this occur, force the eye open and flood with cool, clean water for five minutes. Call a doctor immediately.
- To avoid shocks, burns or damage to electrical system, disconnect battery ground cable before working in an area where you might accidentally contact electrical components.
- Do not operate the engine with alternator or battery disconnected. With battery cables disconnected and engine running, a high voltage can be built up if terminals touch the frame. Anyone touching the frame under these conditions would be severely shocked.

- When working around storage batteries, remember that all of the exposed metal parts are "live". Never lay a metal object across the terminals because a spark or short circuit will result.

7.10.1.1 Maintenance



CAUTION

Do not attempt to service battery unless you have the proper equipment and experience to perform the job. Have it done by a qualified dealer

- a. Check battery charge once a year, more often if operating in cold weather. Hydrometer readings should be 1.260 to 1.300. Readings below 1.250 indicate charging is required. See Section 7.10.1.3 Charging. Add electrolyte if necessary. See Section 7.10.1.5 Adding Electrolyte.
- b. Keep battery clean by wiping it with a damp cloth.
- c. Keep all connections clean and tight. Remove any corrosion and wash terminals with a solution of baking soda and water. A light coating of grease on terminals (after cables are attached) will reduce corrosion.
- d. To prolong battery life, store batteries fully charged and at +20° to +80°F (-7° to +26°C). Check voltage after storage and recharge as needed, according to battery and charger manufacturer recommendations.
- e. Do not stack storage batteries on top of each other.

7.10.1.2 Battery Main Disconnect Switch

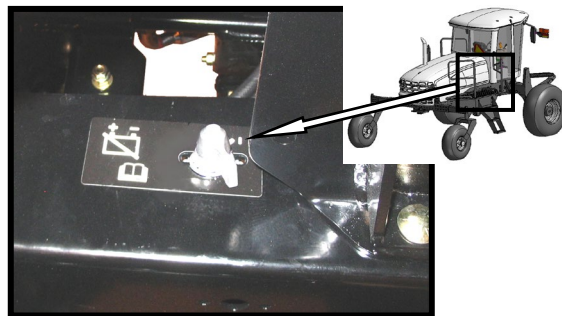

A battery main disconnect switch is located on the RH frame rail, just behind the cab and can be easily accessed by raising the engine compartment hood. Ensure switch is switched to power off position when performing major servicing to electrical components or for periods of non-use to prevent inadvertent loss of battery charge.

MAINTENANCE/SERVICE

7.10.1.3 Charging



CAUTION

- Ventilate the area where batteries are being charged.
- Do not charge a frozen battery. Warm to 60°F (16°C) before charging.
- Do not connect or disconnect live circuits. To prevent sparks, turn off charger and connect positive cable first. If charging battery in windrower, disconnect positive battery cable before connecting charger cable, then connect ground cable last, away from battery.
- Stop or cut back charging rate if battery feels hot, or is venting electrolyte. Battery temperature must not exceed 125°F (52°C).

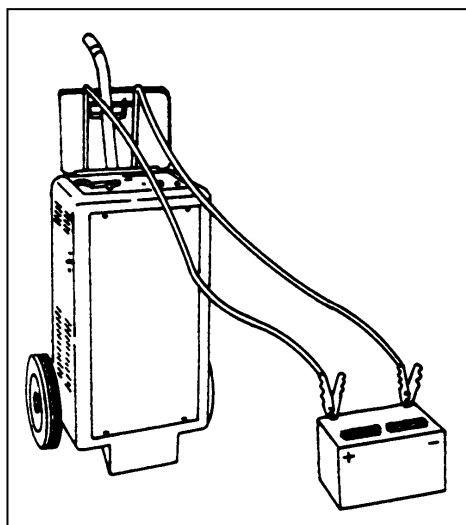

- Follow all instructions and precautions furnished by the battery charger manufacturer. Charge at recommended rates and times.

7.10.1.4 Boosting

A twelve volt battery can be connected in parallel (+ to +) with the windrower battery. Use heavy duty battery cables.



CAUTION

- Gas given off by batteries is explosive. Keep sparks and flames away from batteries.
 - Make last connection and first disconnection at a point furthest away from the batteries.
 - Wear protective eye-wear when using a booster battery.
 - Be sure everyone is clear of machine when starting engine. Start engine from operator's station only.
- a. Move platform on right cab-forward side of machine to open position to allow access to the battery.

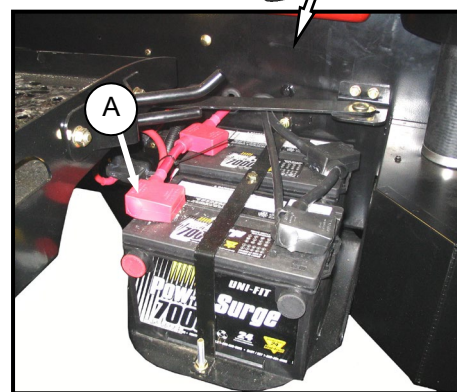
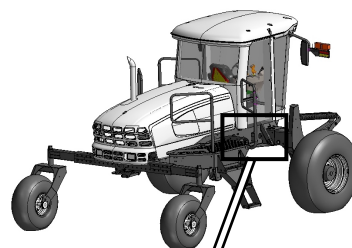

- b. Remove red rubber cover (A) from windrower battery positive terminal.

(continued next page)

MAINTENANCE AND SERVICE

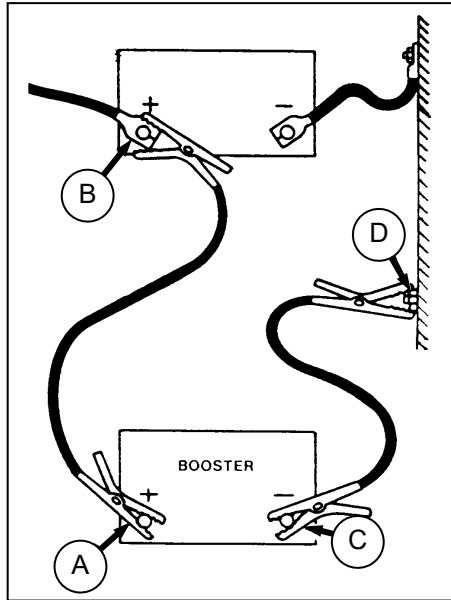

- c. Attach one end of battery cable to positive terminal (A) of booster battery and other end to positive terminal (B) of windrower batteries.
- d. Attach second cable to negative terminal (C) of booster battery and then to a good ground (D) on windrower frame.
- e. Turn ignition switch in cab as with normal start up.
- f. After engine starts, disconnect cable from windrower ground first, and then disconnect the other cables.
- g. Move platform back to closed position.

7.10.1.5 Adding Electrolyte



WARNING

- Keep all smoking materials, sparks and flames away from electrolyte container and battery, as gas given off by electrolyte is explosive.
- Battery electrolyte causes severe burns. Avoid contact with skin, eyes or clothing. Wear protective eyewear and heavy gloves.

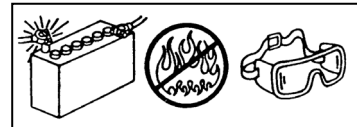

WARNING

If electrolyte is spilled or splashed on clothing or on the body, neutralize it immediately with a solution of baking soda and water, then rinse with clean water. Electrolyte splashed into the eyes is extremely dangerous. Should this occur, force the eye open and flood with cool, clean water for five minutes. Call a doctor immediately.

- a. If battery is installed in windrower, shutdown the engine and remove the key.

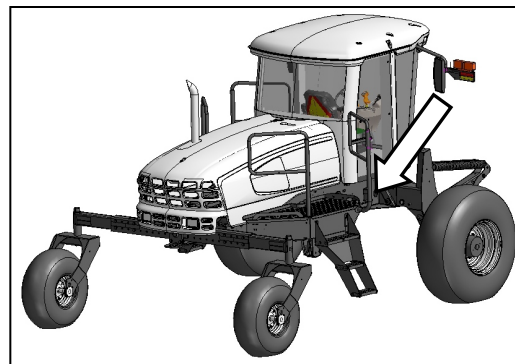

- b. Move platform on right cab-forward side of machine to rear to allow access to the battery.
- c. Add electrolyte in accordance with the battery manufacturer's instructions.
- d. Move platform back to normal position. Ensure lock engages.

MAINTENANCE/SERVICE

7.10.1.6 Replacing Battery



CAUTION

Do not attempt to service battery unless you have the proper equipment and experience to perform the job. Have it done by a qualified dealer



DANGER

Stop engine and remove key from ignition before leaving operator's seat for any reason. A child or even a pet could engage an idling machine.

- Stop engine and remove key.
- Move platform on right cab-forward side of machine to open position to allow access to the battery.

NOTE

If increased access is required, open platform as described in Section 7.5.2 Opening/Closing Platform for Major Servicing.

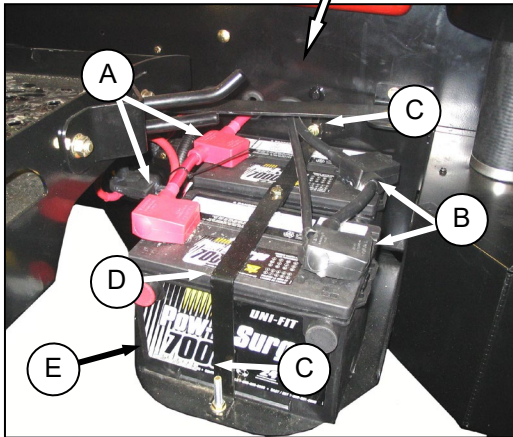

- Remove red plastic cover from positive cable clamps (A). Loosen the clamps and remove cable from batteries.
- Loosen clamps (B) on negative terminals and remove cable from batteries.

- Remove bolts (C) securing strap (D) to frame, and remove strap.
- Lift batteries off holder (E).

| RATING | GROUP | CCA | VOLT | MAX. DIMENSION |
|---|---------|-----|------|--------------------------------------|
| Heavy Duty, Off-Road, Vibration Resistant | BCI 31A | 750 | 12 | 13x6.81x9.44 in. (337x188x240 mm) |

NOTE

Battery holder (E) can be removed from frame by simply lifting holder and pulling it away from frame.

- Position new batteries on holder (E).
- Install strap (D) with bolts (C).

IMPORTANT

BATTERY IS NEGATIVE GROUNDED. Always connect starter cable to the positive (+) terminal of battery and battery ground cable to negative (-) terminal of battery. Reversed polarity in battery or alternator may result in permanent damage to electrical system.

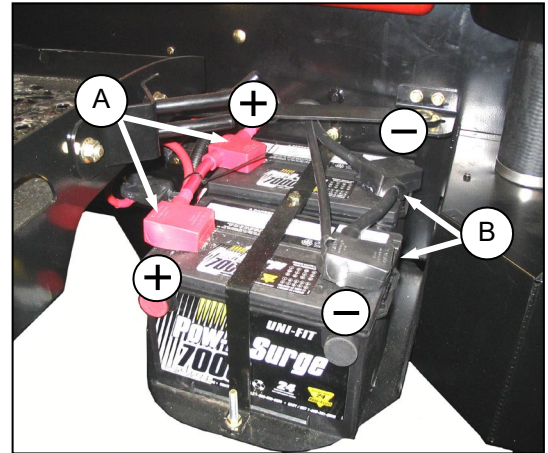

- Attach negative (black) cable clamps (B) to negative post on batteries and tighten clamps.
- Attach positive (red) cable clamps (A) to positive post on batteries and tighten. Reposition plastic covers onto clamps.
- Move platform back to closed position.

MAINTENANCE AND SERVICE

7.10.1.7 Preventing Electrical System Damage

- a. Carefully observe polarity when attaching booster battery.
- b. Do not short across battery or alternator terminals, or allow battery positive (+) cable or alternator wire to become grounded.
- c. Be sure alternator connections are correct before cables are connected to battery. Refer to illustration below.
- d. When welding on any part of the machine, disconnect battery cables and alternator wire. See also Section 7.1.1 Welding Precautions.
- e. Always disconnect battery ground cable when working with the alternator or regulator.
- f. Never attempt to polarize alternator or regulator.
- g. If wires are disconnected from the alternator, use the illustration below to ensure proper reconnection.

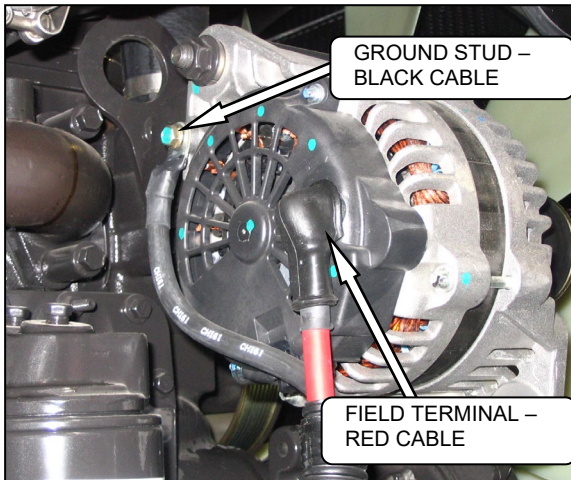

- h. Never ground the alternator field terminal or field circuit.
- i. Never connect or disconnect alternator or regulator wires with battery connected or alternator operating.
- j. Always disconnect cables from the battery when using a charger to charge battery in windrower.
- k. Ensure all cables are securely connected before operating engine.

MAINTENANCE/SERVICE

7.10.2 HEADLIGHTS: ENGINE-FORWARD



DANGER

Stop engine and remove key from ignition before leaving operator's seat for any reason. A child or even a pet could engage an idling machine.

NOTE

Header should be attached and raised to maintain proper windrower stance.

7.10.2.1 Alignment

- Position windrower on level ground in front of a vertical surface in accordance with the illustration.
- Shutdown engine and remove the key.

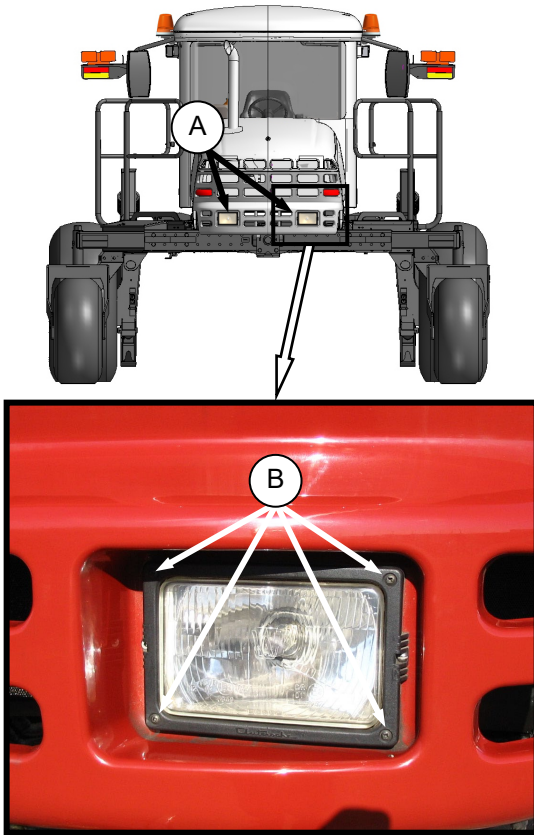

- Turn on the headlights (A) and switch to lo-beam.
- Align the headlights to the following specifications by turning adjusting screws (B).

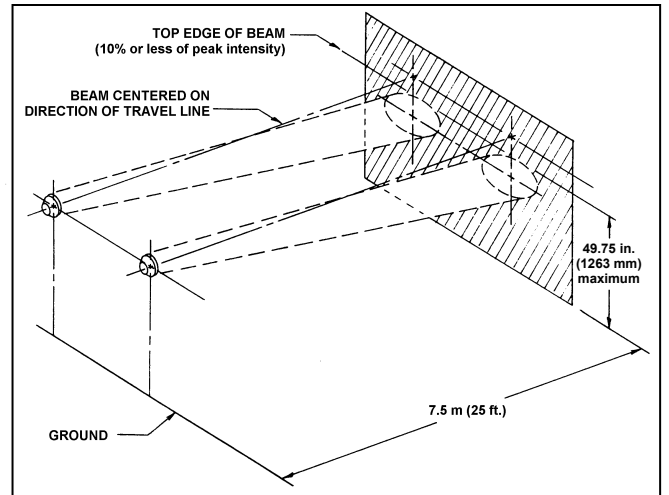

- Adjustments are for lo-beam.
- Light beams laterally centered on the "direction of travel" line from the headlights (i.e. not skewed left or right).
- Upper limit of the beam not higher than 49¾ inches (1263 mm) above ground at a distance of 25 ft. (7.5 m) from the headlight.

7.10.2.2 Bulb Replacement

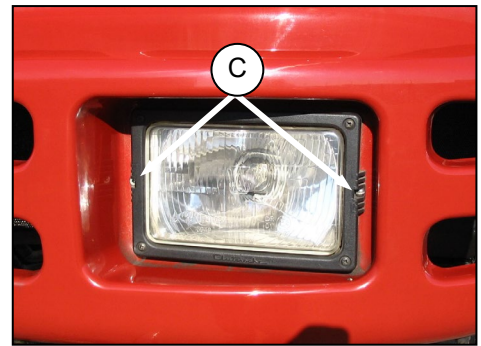

- Remove the two screws (C) and remove headlight assembly from hood.

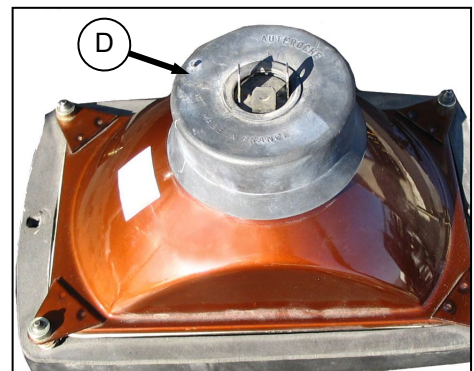

- Pull wiring harness connector off the headlight assembly and remove rubber insulator boot (D).

(continued next page)

MAINTENANCE AND SERVICE

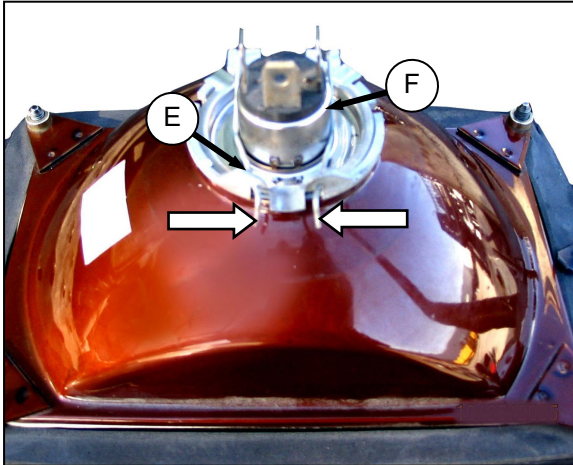

- c. Pinch the wire retainer (E) and lift away from hooks.
- d. Remove bulb (F) from body.

IMPORTANT

Do not touch the glass of the halogen bulb as the oils or other chemicals from your skin will cause the bulb to fail prematurely.

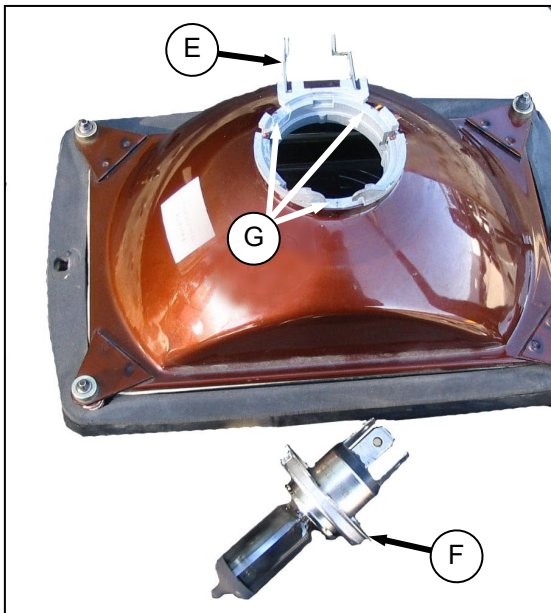

- e. Align lugs on new bulb with slots (G) in body and push into place.
- f. Secure bulb with wire retainer (E)

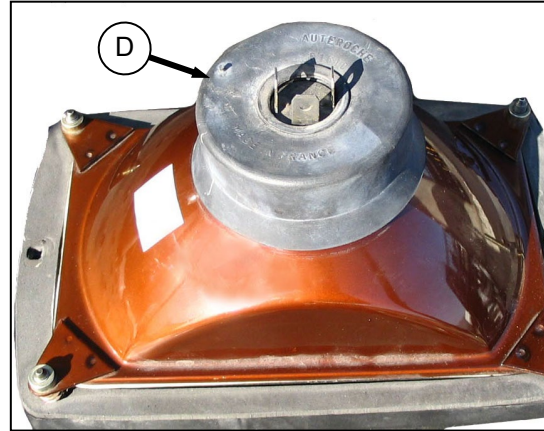

- g. Replace rubber insulator boot (D).
- h. Push connector onto light bulb.

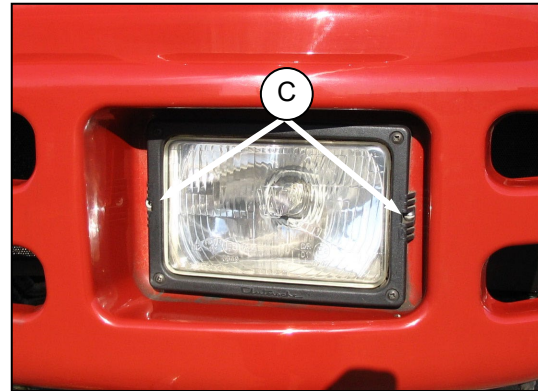

- i. Position headlight into light receptacle, ensuring top is up, and secure with screws (C).

NOTE

Aligning of light should not be necessary.

MAINTENANCE/SERVICE

7.10.3 FIELD LIGHTS: CAB-FORWARD



DANGER

Stop engine and remove key from ignition before leaving operator's seat for any reason. A child or even a pet could engage an idling machine.

7.10.3.1 Adjustment

The field lights are best adjusted with the machine in the field or the equivalent to suit operator preference.

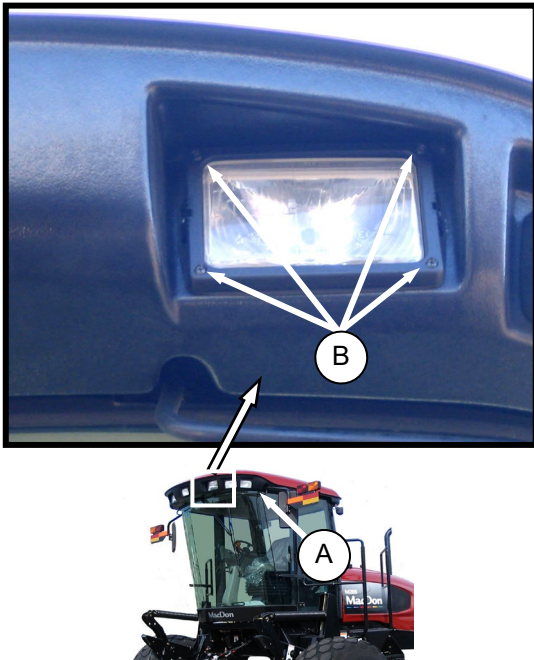

- Hold onto the hand-holds (A) on the cab front corners and stand on the header anti-slip strips.
- Adjust the lights with screws (B).

7.10.3.2 Bulb Replacement

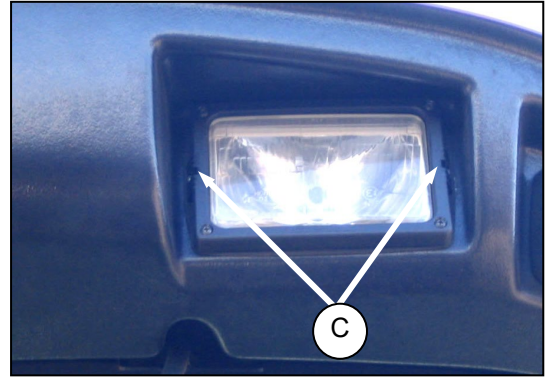

- Remove the two screws (C) and remove light assembly.
- Replace the bulb as described in Section 7.10.2.2.

MAINTENANCE AND SERVICE

7.10.4 FLOOD LIGHTS - FORWARD

The forward floodlights are not adjustable. Replace bulbs as follows:

- a. Shutdown engine and remove the key. Turn off the lights.

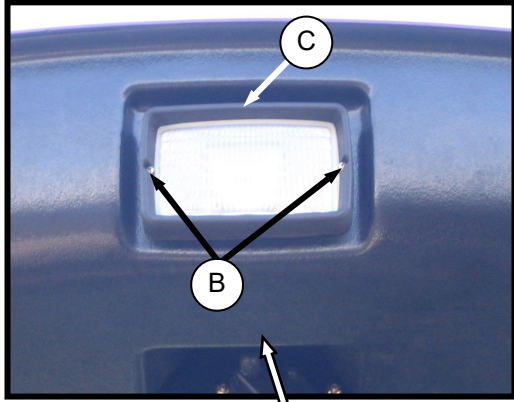

- b. Hold onto the hand-holds (A) on the cab front corners and stand on the header anti-slip strips when removing the forward field lights.
- c. Remove the two screws (B) and remove light bezel (C).

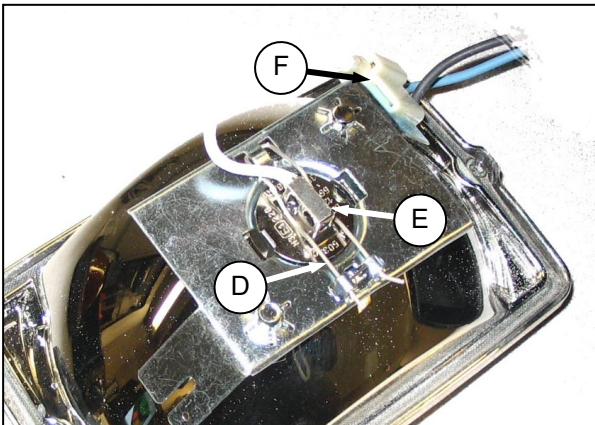

- d. Remove light from receptacle.
- e. Pinch the wire retainer (D) and lift away from hooks.
- f. Remove bulb (E) from body and pull wire from connector (F).

IMPORTANT

Do not touch the glass of the halogen bulb as the oils or other chemicals from your skin will cause the bulb to fail prematurely.

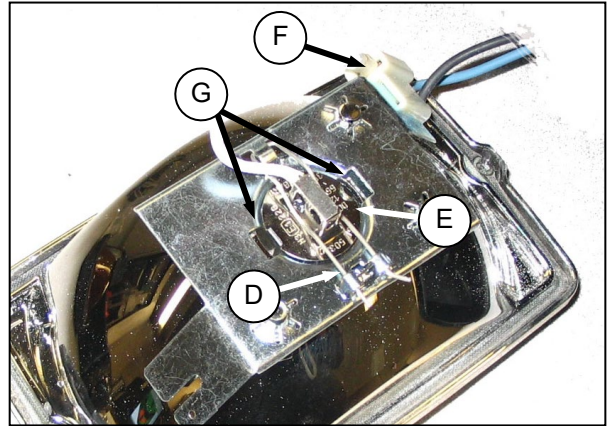

- g. Match slots on new bulb (E) with lugs (G) in optical unit and insert bulb into unit.
- h. Secure bulb with wire retainer (D).
- i. Push wire into connector (F).

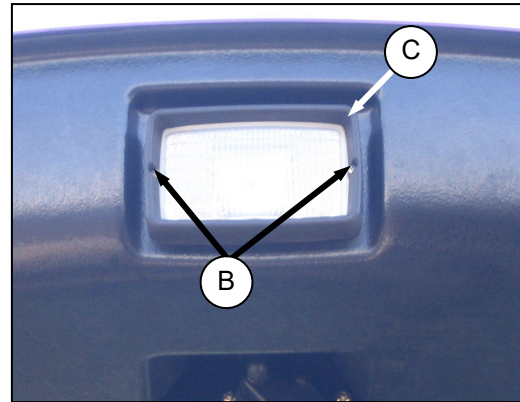

- j. Position light into light receptacle, ensuring top is up, and secure with bezel (C) and screws (B).

MAINTENANCE/SERVICE

7.10.5 FLOOD LIGHTS - REAR



DANGER

Stop engine and remove key from ignition reason. A child or even a pet could engage an idling machine.

7.10.5.1 Adjustment

The rear floodlights are best adjusted with the machine in the field or the equivalent to suit operator preference.

- Shutdown engine and remove the key. Turn on lights.

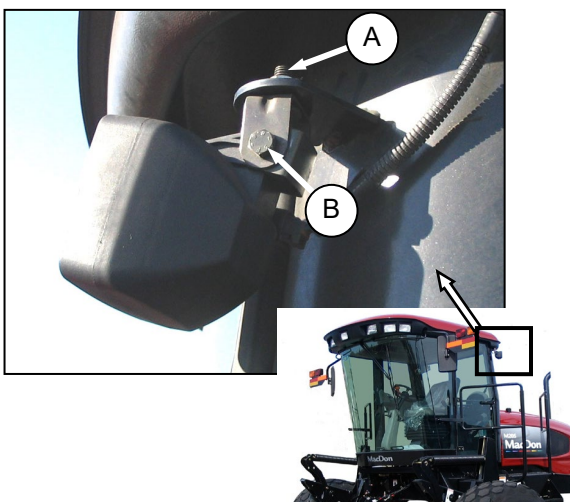

- Loosen bolts (A) and (B).
- Position light to desired position.
- Tighten bolts (A) and (B).

7.10.5.2 Bulb Replacement

- Shutdown engine and remove the key. Turn off the lights.

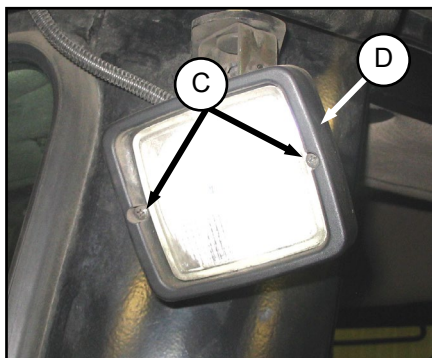

- Remove the two screws (C) and remove light bezel (D).

- Remove light from receptacle.

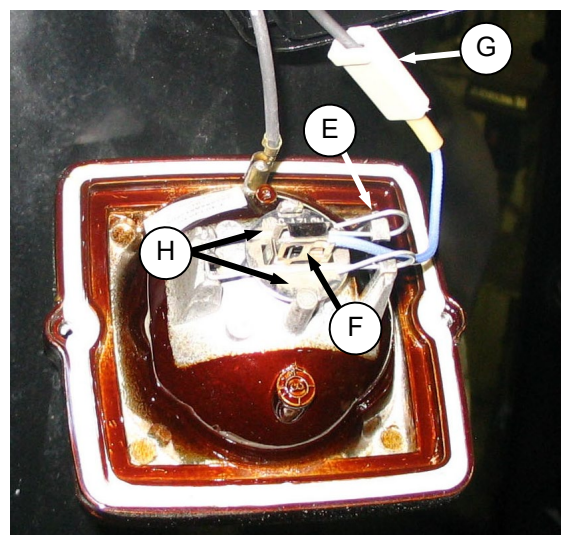

- Pinch the wire retainer (E) and lift away from hooks.
- Remove bulb (F) from body and pull wire from connector (G).

IMPORTANT

Do not touch the glass of the halogen bulb as the oils or other chemicals from your skin will cause the bulb to fail prematurely.

- Match slots on new bulb (F) with lugs (H) in optical unit and insert bulb into unit.
- Secure bulb with wire retainer (E).
- Push wire into connector (G).

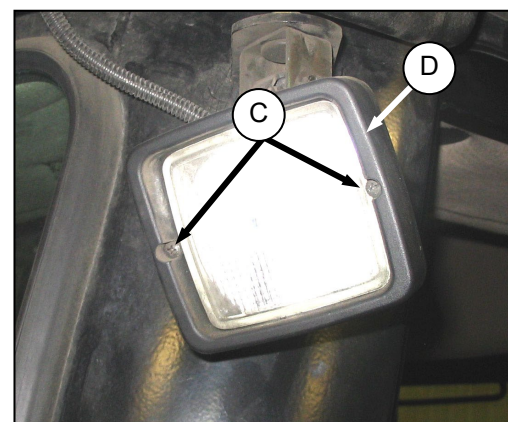

- Position light into light receptacle, ensuring top is up, and secure with bezel (D) and screws (C).

MAINTENANCE AND SERVICE

7.10.6 RED AND AMBER LIGHTS



DANGER

Stop engine and remove key from ignition before leaving operator's seat for any reason. A child or even a pet could engage an idling machine.

- Shutdown engine and remove the key. Turn off the lights.

NOTE

Hold onto the hand-holds (A) on the cab front corners and stand on the header anti-slip strips or stand on the maintenance platform when accessing the red and amber lights.

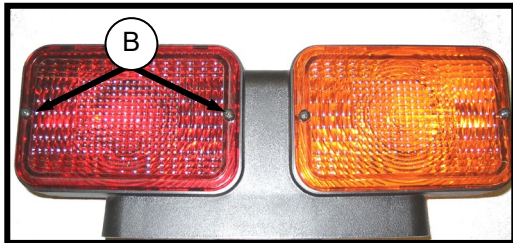

- Remove two screws (B) from lens and remove lens.

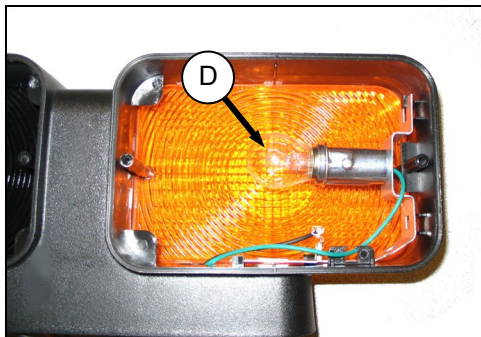

- Push and twist light bulb (D) to remove from socket.
- Install new bulb (D) in socket ensuring that bulb base is properly engaged in socket. Use Bulb Trade #1157 for red tail-lights and #1156 for amber lights.
- Reinstall lens with screws (B).

7.10.7 RED TAIL LIGHTS (IF INSTALLED)



DANGER

Stop engine and remove key from ignition before leaving operator's seat for any reason. A child or even a pet could engage an idling machine.

- Shutdown engine and remove the key. Turn off the lights.

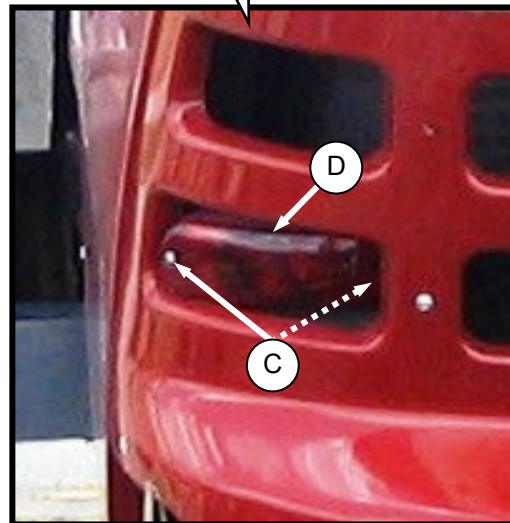
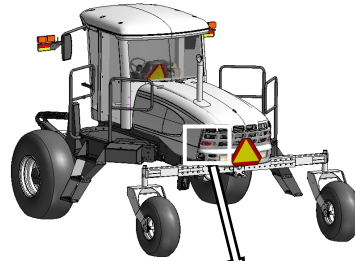

- Remove two screws (C) from light (D) and remove light.
- Remove connector from light.
- Connect wiring harness to new light (D) and install light with screws (C).

MAINTENANCE/SERVICE

7.10.8 BEACONS (IF INSTALLED)

- a. Shutdown engine and remove the key. Turn off the beacons.



NOTE

Hold onto the hand-holds on the cab front corners and stand on the header anti-slip strips or stand on the maintenance platform when accessing the red and amber lights.

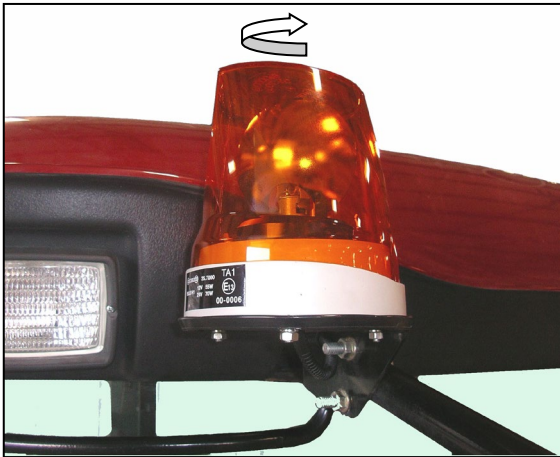

- b. Turn lens counter-clockwise to unlock lens from base and remove lens.

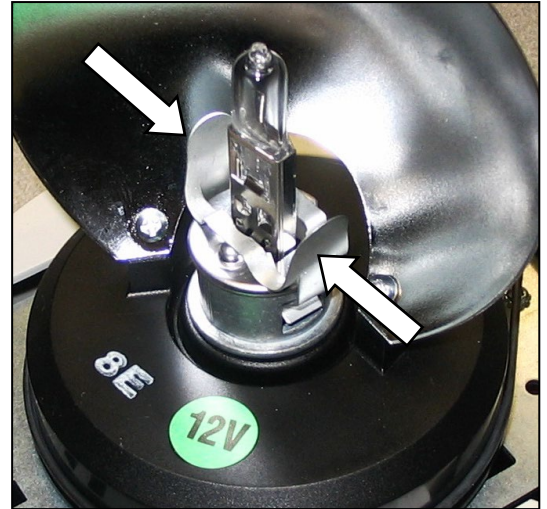

- c. Pinch retainer and remove it from lamp socket.
- d. Pull lamp out of socket.

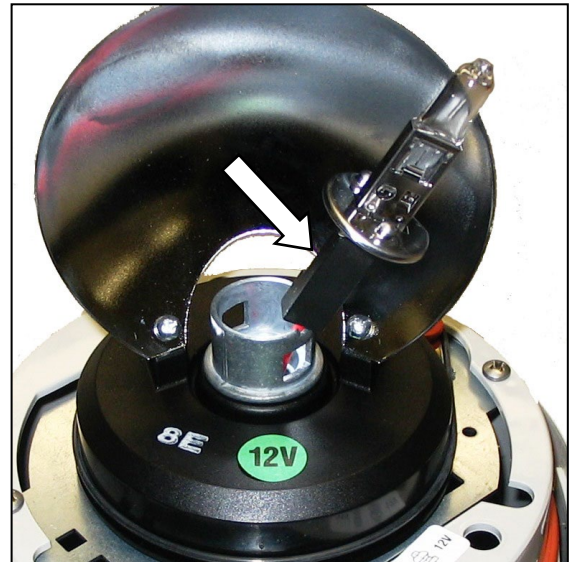

- e. Disconnect harness from lamp.

MAINTENANCE AND SERVICE

IMPORTANT

Do not touch the glass of the halogen bulb as the oils or other chemicals from your skin will cause the bulb to fail prematurely.

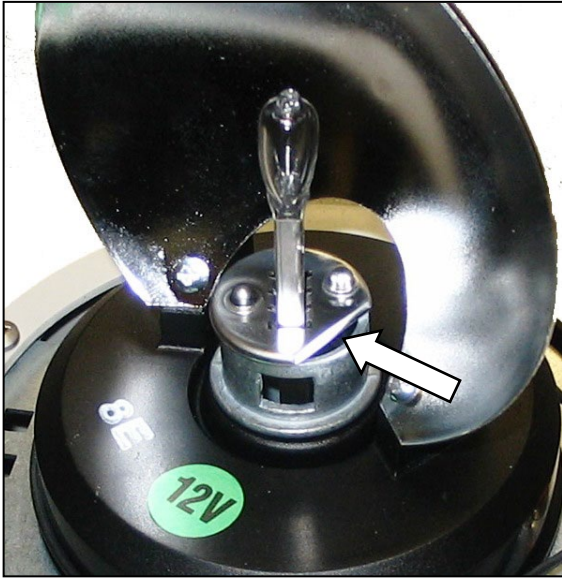

- f. Connect harness to new lamp, place lamp in socket and line up flat side on lamp with recess in socket.

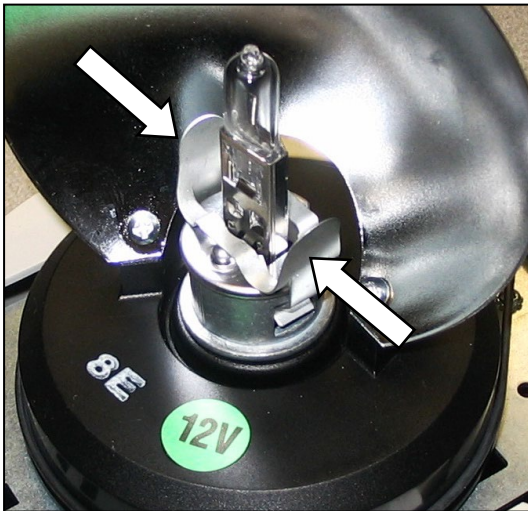

- g. Place retainer over lamp and pinch tabs to secure retainer to socket.

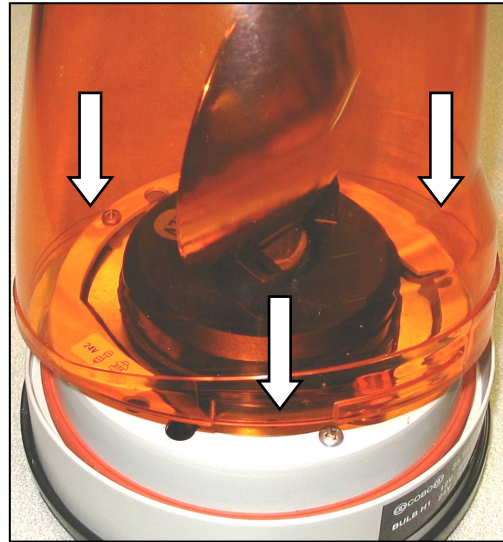

- h. Line up the three lugs (one is longer) in the base with slots in lens and seat the lens against the rubber seal.

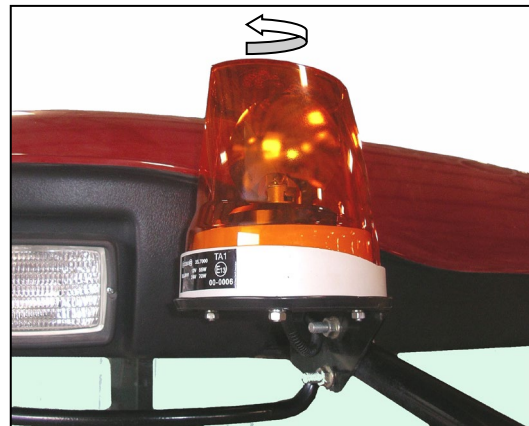

- i. Turn the lens clockwise to lock it in place.

MAINTENANCE/SERVICE

7.10.9 GAUGE LIGHT

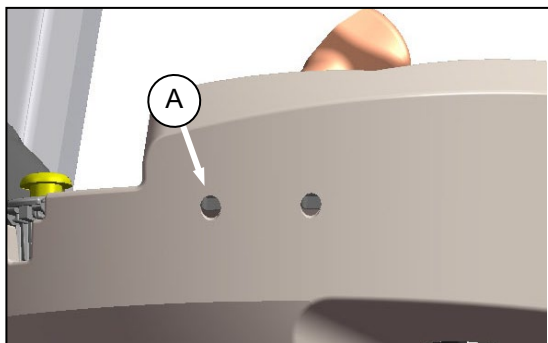

- a. Shutdown engine and remove the key. Turn off the lights.

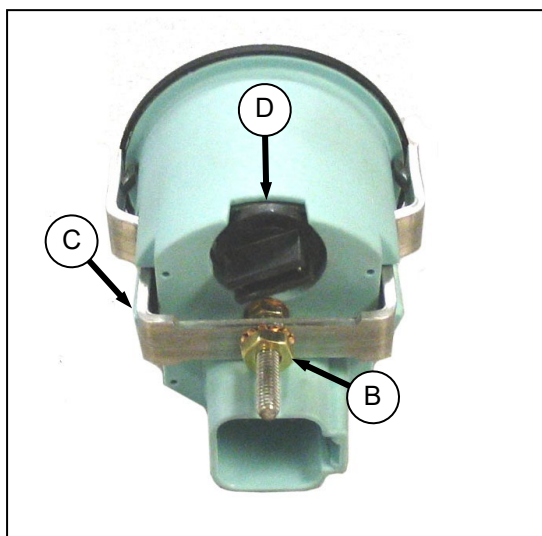

- b. Remove the appropriate gauge access hole decal (A) behind the operator's console.
- c. Remove nut (B) securing mounting bracket (C) to gauge inside the console.
- d. Pull gauge out from console. It is not necessary to disconnect the wiring harness to back of gauge.
- e. Twist bulb holder (D) counterclockwise until loose and pull bulb holder from back of gauge.
- f. Insert new bulb into gauge and turn clockwise until it locks.
- g. Push gauge into console.
- h. Locate bracket (C) onto back of gauge and secure with nut (B). Tighten nut to 75-96 in-oz (530-678 mN·m).
- i. Replace gauge access-hole decal (A).

7.10.10 DOME LIGHT

- a. Shutdown engine.

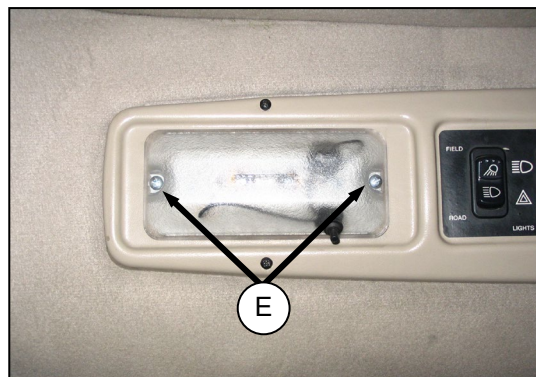

- b. Remove two screws (E) from plastic lens and remove lens.
- c. Replace bulb.
- d. Reinstall plastic lens with screws (E).

7.10.11 AMBIENT LIGHT

- a. Shutdown engine.

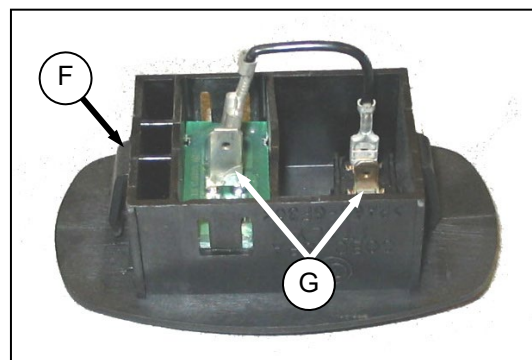

- b. Push against tabs (F) with a screwdriver and pull ambient light fixture out of cab roof.
- c. Remove wires from connectors (G).
- d. Connect wires to new light fixture.
- e. Push into place in cab roof until tabs hold fixture in place.

7.10.12 TURN SIGNAL INDICATORS

If the turn signal indicators on the CDM do not function, contact your Windrower dealer.

MAINTENANCE AND SERVICE

7.10.13 CIRCUIT BREAKERS AND FUSES



DANGER

Stop engine and remove key from ignition before leaving operator's seat for any reason. A child or even a pet could engage an idling machine.

The circuit breakers and fuses are located inside the fuse box that is mounted on the frame under the right cab-forward side platform. The circuit breakers automatically reset and the fuses are the plastic blade type.

Access the breakers and fuses as follows:

- Stop engine and remove key.
- Move right cab-forward side platform rearward (cab-forward).

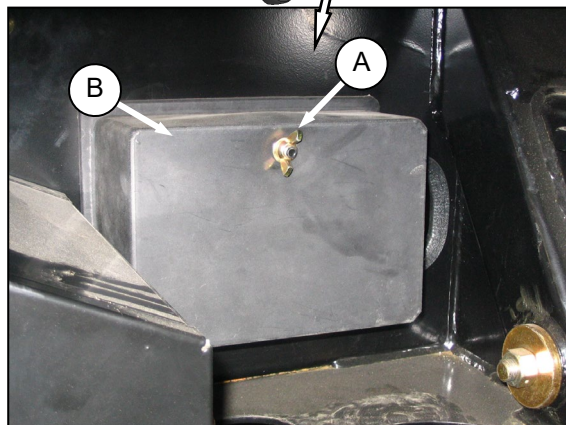
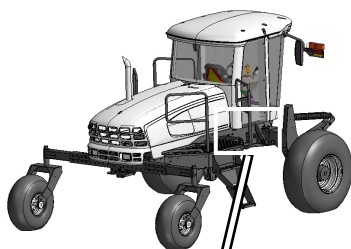

- Remove wing nut (A) and remove fuse box cover (B).
- Refer to decal on inside of cover for identification of fuses and circuit breakers. See illustration next page.

7.10.13.1 Checking/Replacing Fuses

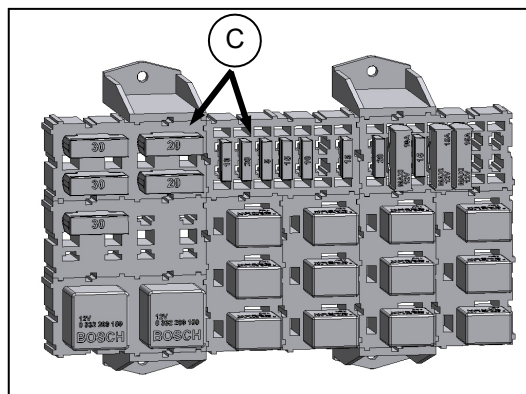

- To check fuse, pull fuse (C) out of receptacle and visually examine.
- To replace fuse, insert new fuse into receptacle.

IMPORTANT

Replacement fuses should match rating on decal shown on following page.

7.10.13.2 Replacing Circuit Breakers

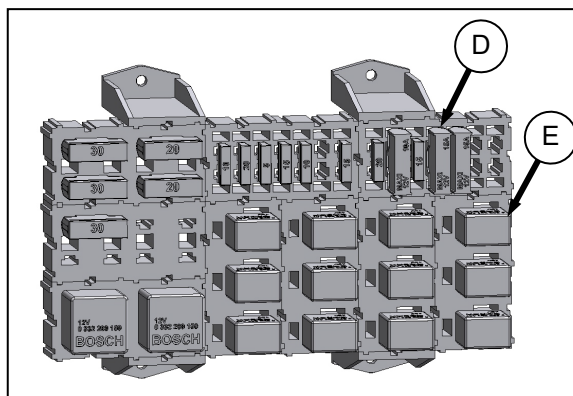

- To replace circuit breaker (D), pull breaker out of receptacle, and install new circuit breaker.
- To replace relay (E), pull relay out of receptacle, and install new relay.
- Reinstall cover and secure with wing nut.

(continued next page)

MAINTENANCE/SERVICE

7.10.13.3 Fuse Box Decal

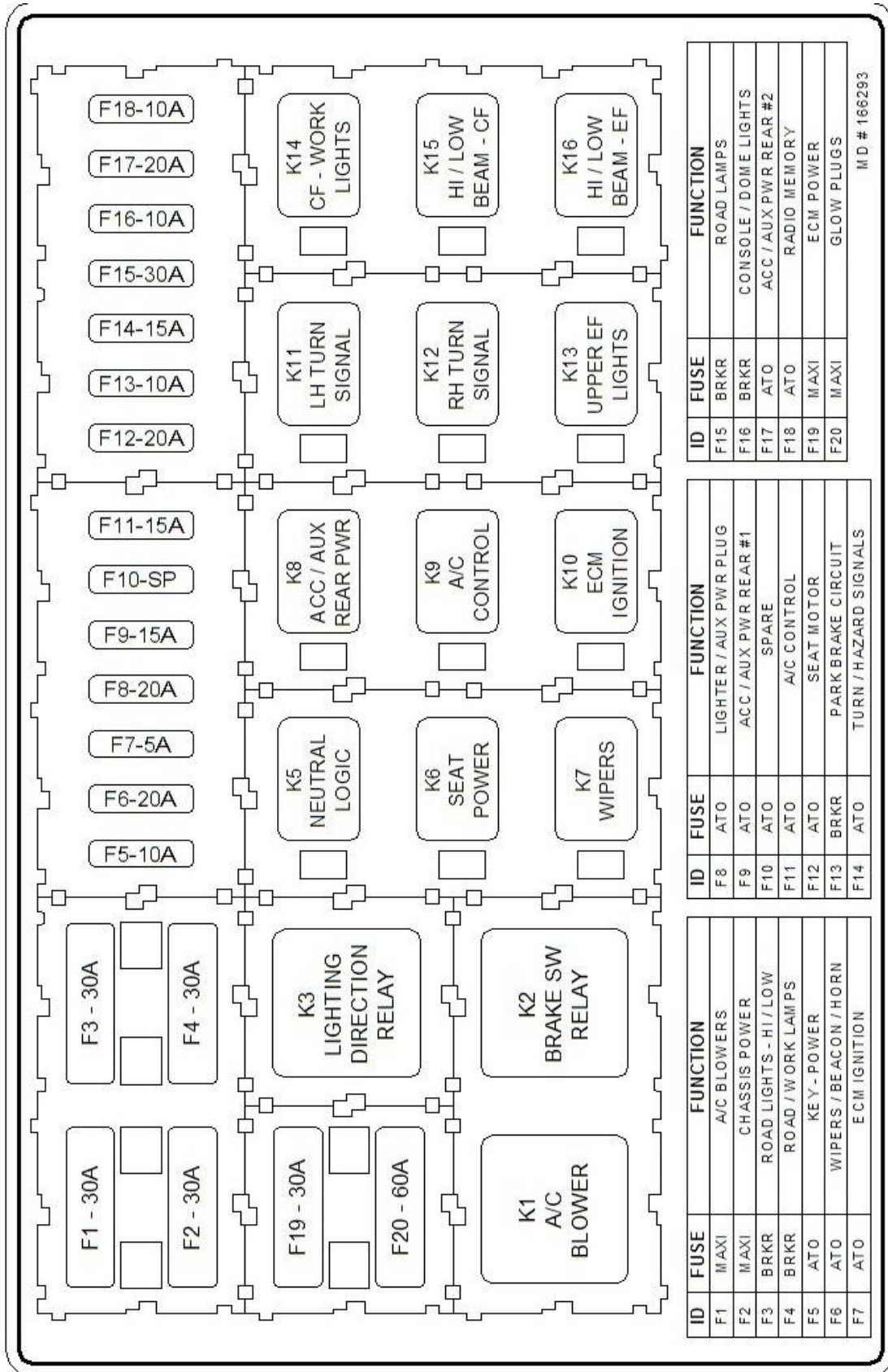

MD # 166293

MAINTENANCE AND SERVICE

7.10.13.4 Main Fuses - 125 Amp

The 125 amp main fuse holders are located on the frame under the right cab-forward side platform beside the battery. Access the fuses as follows:



DANGER

Stop engine and remove key from ignition before leaving operator's seat for any reason. A child or even a pet could engage an idling machine.

- Stop engine and remove key.
- Move right cab-forward side platform rearward (cab-forward).

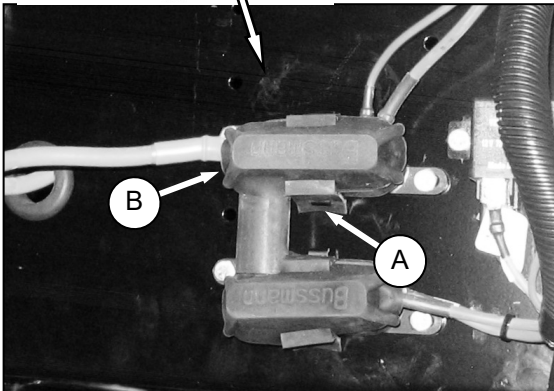

- To check condition of fuse, pull tab (A) and open cover (B).

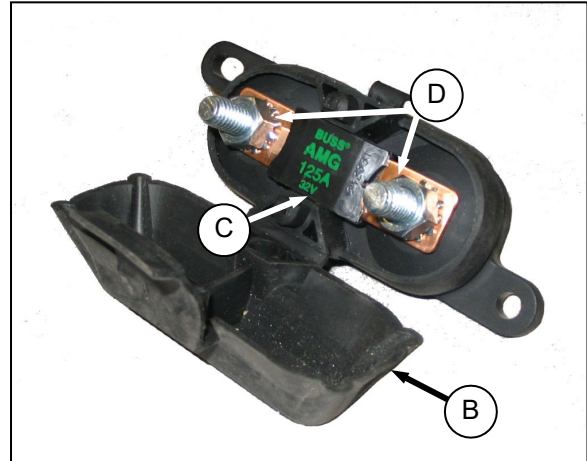

- Visually examine fuse (C) for indications of melting.
- To remove fuse (C), remove two nuts (D) and pull fuse free from holder. Existing wiring may need to be pulled off the stud first.
- Install new fuse on studs and any existing wiring that was removed.
- Secure with nuts (D).
- Close cover (B) and secure with tab (A).
- Return platform to normal position. Ensure lock engages.

MAINTENANCE/SERVICE

7.11 HYDRAULIC SYSTEM

The M205 Windrower hydraulic system provides oil for the windrower drive system, and header lift and drive systems.



WARNING

Avoid high pressure fluids. Escaping fluid can penetrate the skin causing serious injury. Relieve pressure before disconnecting hydraulic lines. Tighten all connections

before applying pressure. Keep hands and body away from pinholes and nozzles which eject fluids under high pressure. Use a piece of cardboard or paper to search for leaks. If ANY fluid is injected into the skin, it must be surgically removed within a few hours by a doctor familiar with this type of injury or gangrene may result.

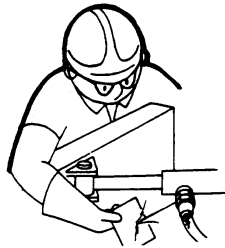
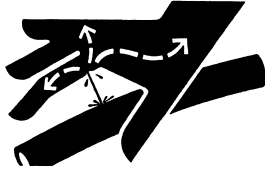

IMPORTANT

Dirt, dust, water and foreign material are the major causes of trouble developing in the hydraulic system. If the hydraulic system should be disconnected for service, protect the ends of hoses, tubing and ports of components from contamination with clean, lint-free towels or clean plastic bags. Before installing any replacement hose, flush the inside of it with unused diesel fuel or unused commercial petroleum cleaning solvent for ten seconds minimum. Do not use water, water soluble cleaners or compressed air.

IMPORTANT

The components in this system are built to very close tolerances and have been adjusted at the factory. Do not attempt to service these components except to maintain proper oil level, change oil and filters and to adjust relief pressures as described in this manual. See your Windrower Dealer for all other service.

7.11.1 OIL LEVEL

Check hydraulic oil level daily as follows:



DANGER

Stop engine and remove key from ignition before leaving operator's seat for any reason. A child or even a pet could engage an idling machine.

- Park windrower on level ground and lower header and reel so that lift cylinders are fully retracted.
- Stop engine and remove key.
- Stand on left cab-forward side platform to access the filler pipe.

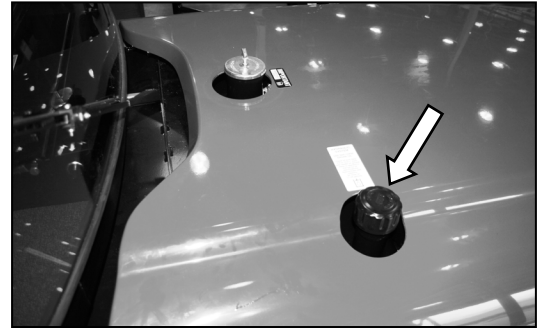

- Turn filler cap counterclockwise approximately one-quarter turn to unlock, and remove cap and dipstick.

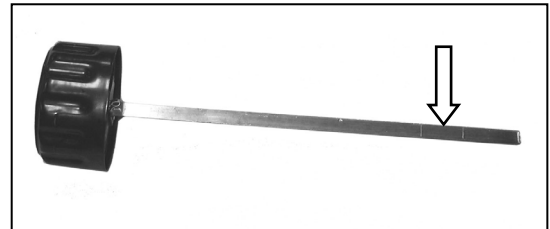

- Maintain level between LOW and FULL marks. If necessary, add SAE 15W40 Compliant with SAE Specs for API Class SJ and CH-4 Engine Oil.

IMPORTANT

- Use good quality oil that has been pre-filtered.
- Exercise care to prevent debris from falling into tank.

NOTE

LOW to FULL capacity is approximately 1 U.S. gallon (4 litres).

- Reinstall dipstick and filler cap, and turn clockwise to lock.

(continued next page)

MAINTENANCE AND SERVICE

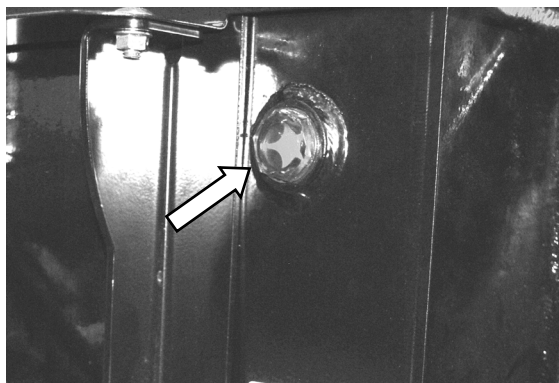

- g. A sight glass on the tank provides a quick indication of low oil level and also shows if the oil is contaminated. No oil in the sight glass indicates oil level is below the add mark on the dipstick.

7.11.2 HYDRAULIC OIL COOLER

The hydraulic oil cooler is located inside the cooling box behind the radiator. It should be cleaned daily with compressed air. Refer to Section 7.9.3 Cooling Box Maintenance.

7.11.3 CHANGING HYDRAULIC OIL

NOTE

Change hydraulic oil every 1500 hours.

- Stop engine and remove key.
- Open engine compartment hood to highest position.
- Place a suitable container (at least 20 gal. US (75 litres)) under drain to collect oil.

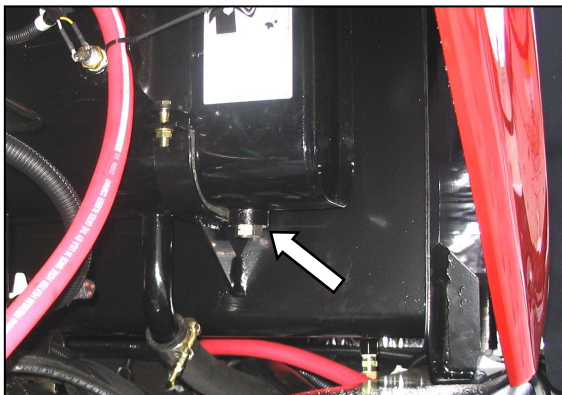

- Remove drain plug from bottom of hydraulic oil reservoir and allow oil to drain.
- Change the lift filter. See 7.11.4.1 Lift Filter.
- Clean off any metal debris that may have accumulated on magnetic drain plug. Replace and tighten drain plug.
- Add oil to the tank to the required level through the filler pipe. Refer to previous section.

7.11.4 HYDRAULIC OIL FILTERS

Change hydraulic oil filters as follows:



DANGER

Stop engine and remove key from ignition before leaving operator's seat for any reason. A child or even a pet could engage an idling machine.

7.11.4.1 Lift Filter

NOTE

Change filter when changing hydraulic oil. Filter) part #112419 can be obtained from your dealer.

IMPORTANT

If filter needs to be changed at any other time, a vacuum must be applied to the supply tank to prevent the oil from running out of the filter head when the filter is removed.

- Stop engine and remove key.
- Open engine compartment hood to highest position.

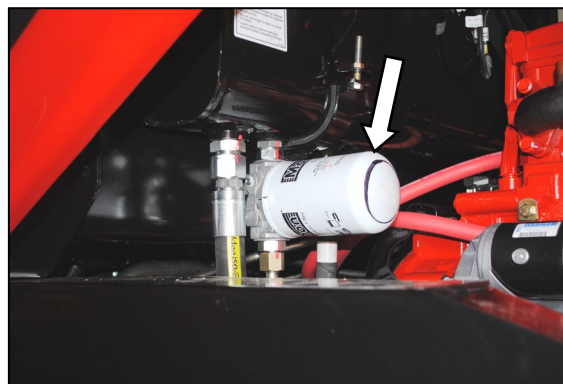

- Clean around head of the filter.
- Unscrew the filter with a filter wrench.
- Clean the gasket surface of the filter head.
- Apply a thin film of clean oil to the filter gasket.
- Screw the new filter onto the mount until the gasket contacts the filter head.
- Tighten filter an additional $\frac{1}{2}$ turn by hand.

IMPORTANT

Do not use a filter wrench to install oil filter. Over-tightening can damage gasket and filter.

MAINTENANCE/SERVICE

7.11.4.2 Charge Filter

NOTE

Change hydraulic oil filter after the first 50 hours of operation and every 500 hours thereafter. Filter part #112419 can be obtained from your dealer.

- Stop engine and remove key.

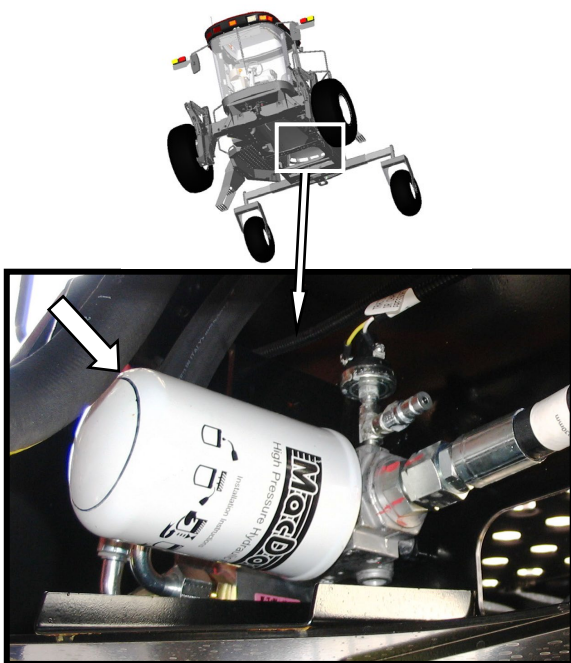

- Clean around head of the filter.
- Unscrew the filter with a filter wrench.
- Clean the gasket surface of the filter head.
- Apply a thin film of clean oil to the filter gasket.
- Screw the new filter onto the mount until the gasket contacts the filter head.
- Tighten filter an additional $\frac{1}{2}$ turn by hand.

IMPORTANT

Do not use a filter wrench to install oil filter. Over-tightening can damage gasket and filter.

7.11.4.3 Return Filter

NOTE

The return filter is a part of the hydraulics package required to run a draper or auger header.

NOTE

Change hydraulic oil filter after the first 50 hours of operation and every 500 hours thereafter. Filter part #112419 can be obtained from your dealer.

- Stop engine and remove key.
- Move left cab-forward platform out to maintenance position.

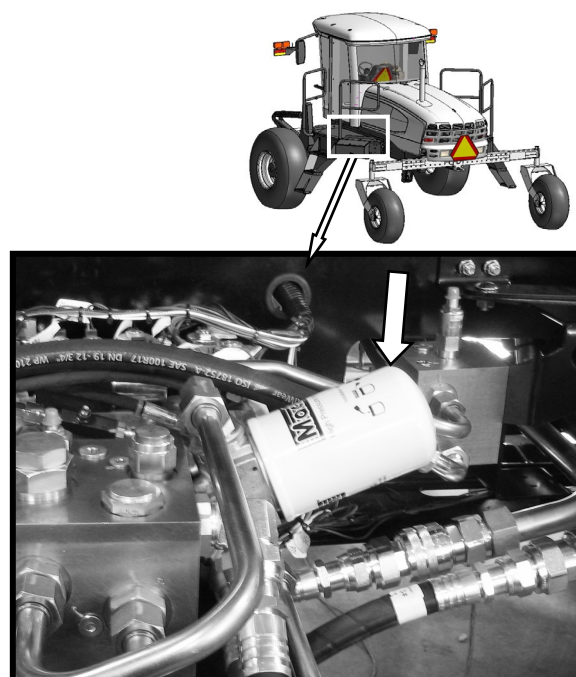

- Clean around head of the filter.
- Unscrew the filter with a filter wrench.
- Clean the gasket surface of the filter head.
- Apply a thin film of clean oil to the filter gasket.
- Screw the new filter onto the mount until the gasket contacts the filter head.
- Tighten filter an additional $\frac{1}{2}$ turn by hand.

IMPORTANT

Do not use a filter wrench to install oil filter. Over-tightening can damage gasket and filter.

MAINTENANCE AND SERVICE

7.11.5 HEADER AND REEL HYDRAULICS

7.11.5.1 Relief Valves

The pressure relief valves are pre-set for all header sizes and options. See table below.

When the system operating pressure reaches the relief valve setting, the relief valve opens which causes a high pitch sound. Reduce the ground speed to maintain the correct system load and header drive operation.

An optional load sensor may be installed to warn the operator that the system pressure is approaching an overload condition, by a tone and flashing the pressure reading. The load will continue to rise if the operator does not reduce ground speed and the relief valve opens at the relief valve setting. See table below for recommended settings.

If lift and drive capacity problems develop, the pressure relief valve may require adjusting. Contact your Windrower Dealer or refer to the Technical Service Manual for your Windrower.

| HEADER MODEL | APPLICATION/SYSTEM | SUGGESTED OVERLOAD WARNING SETTING psi (kPa) | WINDROWER DIFFERENTIAL RELIEF SETTING psi (kPa) |
|--------------|----------------------------|---|--|
| R80/R85 | Disc Pressure | 5000 (34474) | 5800 (39990) |
| D60 & A40D | Reel/Draper Pressure | 3000 (20684) | 3500 (24132) |
| D60 & A40D | Knife/Conditioner Pressure | 4000 (27579) | 4500 (31026) |

7.11.5.2 Flow Control Block

Two hydraulic valve blocks with multiple cartridges are used for the various windrower functions and are controlled by the Windrower Control Module (WCM) according to the inputs from the operator. The valve blocks are located behind the left cab-forward side platform.

The valve blocks do not require any scheduled maintenance other than to check for leaking fittings or loose electrical connections. If service is required, contact your Windrower Dealer or refer to the Technical Service Manual for your Windrower.

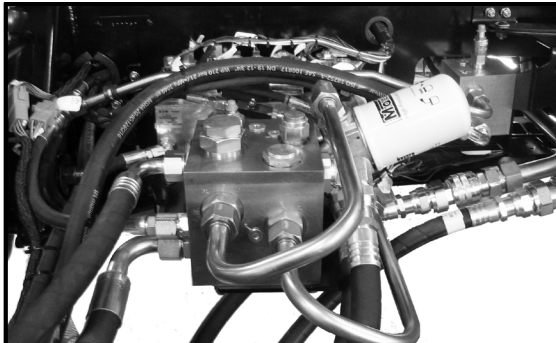
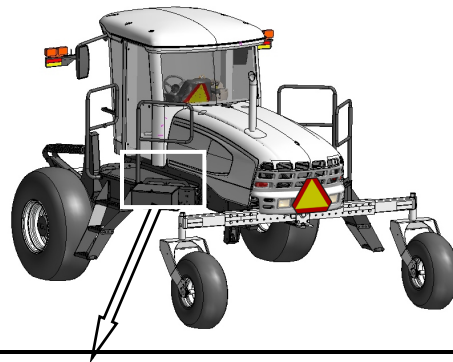

DRAPER HEADER HYDRAULICS

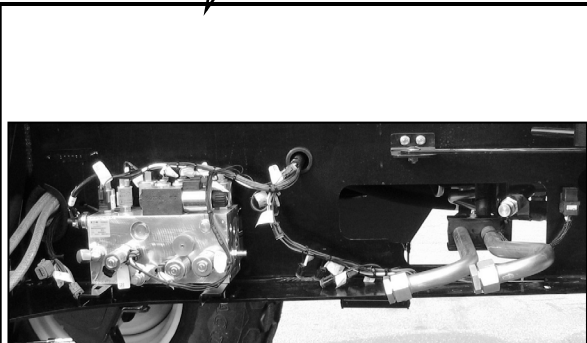

ROTARY DISC HEADER HYDRAULICS

MAINTENANCE/SERVICE

7.11.5.3 Header Drop Rate

The header should lower gradually when the lower header switch is pressed. From full height to ground should take approximately 3.5 seconds.

Adjust as follows:



DANGER

Stop engine and remove key from ignition before leaving operator's seat for any reason. A child or even a pet could engage an idling machine.

- a. Lower header to ground, stop engine, and remove key.

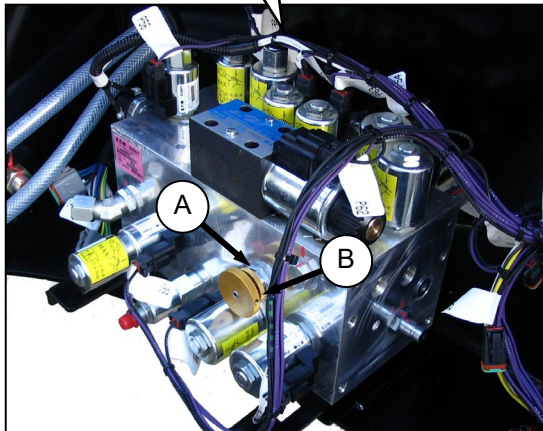
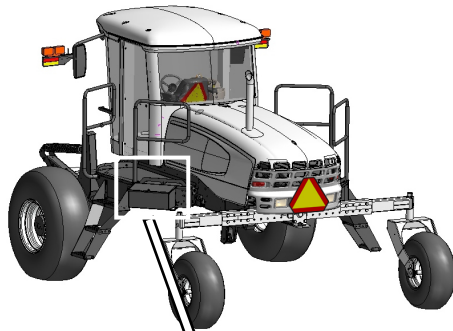

THERE MAY BE A FLOW RESTRICTOR FOR REEL DROP RATE. ONLY HEADER CONTROL SHOWN

- b. Move left cab-forward side platform rearward.
- c. Loosen knob (A) on needle valve and then turn knob (B) clockwise to decrease the drop rate and counter-clockwise to increase the drop rate.
- d. Tighten jam-nut (A).
- e. Close platform and engine compartment hood.
- f. Check drop rate and re-adjust as required.

MAINTENANCE AND SERVICE

7.11.6 TRACTION DRIVE HYDRAULICS

7.11.6.1 Transmission Oil Pressure

The windrower transmission consists of two variable displacement axial piston hydraulic pumps, one for each drive wheel. The pumps are driven through a gearbox from the engine. Each pump requires charge flow to make up for internal leakage, maintain positive pressure in the main circuit, provide flow for cooling and replace any leakage losses from external valving or auxiliary systems. The charge pressure is monitored and if it drops below 250 psi (1725 kPa), the CDM sounds a tone and displays a flashing warning. Refer to Section 5.18.4 Cab Display Module Warnings and Alarms.

IMPORTANT

Rated charge pressure must be maintained under all conditions of operation to prevent damage to the transmission.

If the TRANS OIL PRESSURE warning is displayed, shutdown the engine and proceed as follows:

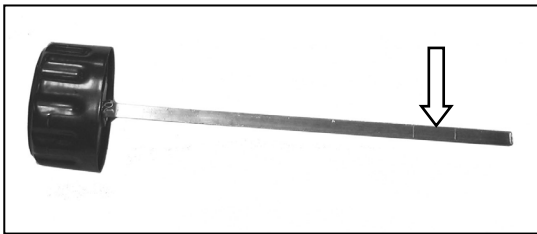

- Check the hydraulic fluid level in the tank. Refer to Section 7.11.1 Oil Level.
- Check the hoses and lines for leakage.
- Check the charge pressure relief valve. Refer to following section.
- If charge pressure still cannot be maintained, do not operate the windrower. Contact your windrower dealer.

7.11.6.2 Charge Pump Pressure

Incorrect charge pressure settings may result in the inability to build required system pressure and/or inadequate loop flushing flows. Correct charge pressure must be maintained under all conditions to maintain pump control performance and to operate the brake release

Check charge pump pressure as follows:



DANGER

Stop engine and remove key from ignition before leaving operator's seat for any reason. A child or even a pet could engage an idling machine.

- Open engine compartment hood fully.
- Attach a 0 - 600 psi (4000 kPa) pressure gauge to a hose that is long enough to allow pressure gauge to be read from the operator's seat.

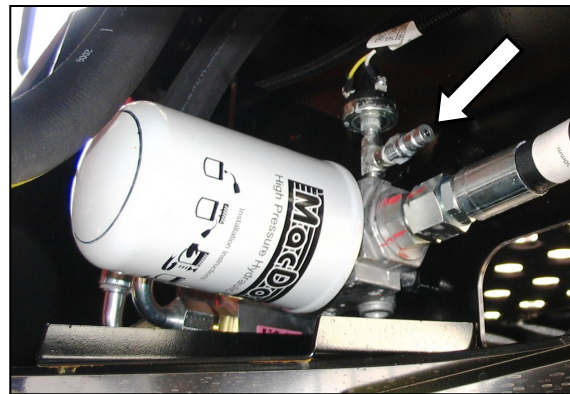

- Clean test port fitting and attach hose to the fitting.
- Start engine and leave at idle. Pressure should be 270 to 300 psi (1862 to 2068) kPa with the hydraulic oil at 100°F. (40°C) minimum.
- If pressure is not within this range, see your MacDon dealer or refer to the Technical Service Manual.

7.11.7 HOSES AND LINES

Check hydraulic hoses and lines daily for signs of leaks.



WARNING

Avoid high-pressure fluids. Escaping fluid can penetrate the skin causing serious injury. Relieve pressure before disconnecting hydraulic lines. Tighten all connections before applying pressure. Keep hands and body away from pin-holes and nozzles which eject fluids under high pressure.



If ANY fluid is injected into the skin, it must be surgically removed within a few hours by a doctor familiar with this type of injury or gangrene may result. Use a piece of cardboard or paper to search for leaks.

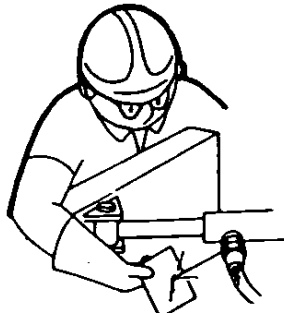

IMPORTANT

Keep hydraulic coupler tips and connectors clean. Dust, dirt, water and foreign material are the major causes of hydraulic system damage. DO NOT attempt to service hydraulic system in the field. Precision fits require WHITE ROOM CARE during overhaul.

MAINTENANCE AND SERVICE

7.12 WHEELS AND TIRES

7.12.1 DRIVE WHEELS

7.12.1.1 Tire Inflation

- a. Visually check daily that tires have not lost pressure. Under-inflation of drive tires can cause side wall cracks.



DANGER

To avoid severe personal injury or death caused by machine runaway, shut off engine and remove key before performing any of the following checks and/or adjustments.

- b. Measure tire pressure annually with a gauge. Maintain the pressure as follows:

Bar – 32 psi (221 kPa)

Turf – 20 psi (138 kPa)



DANGER

- Never install a tube in a cracked wheel rim.
- Never weld a wheel rim.
- Make sure all the air is removed from a tire before removing the tire from the rim.
- Never use force on an inflated or partially inflated tire. Make sure the tire is correctly seated before inflating to operating pressure.
- Do not remove, install or make repairs to a tire on a rim unless you have the proper equipment and experience to perform the job. Take the tire and rim to a qualified tire repair shop.
- If the tire is not in correct position on the rim, or if too full of air, the tire bead can loosen on one side, causing air to leak at high speed and with great force. An air leak of this nature can thrust the tire in any direction, endangering anyone in the area.

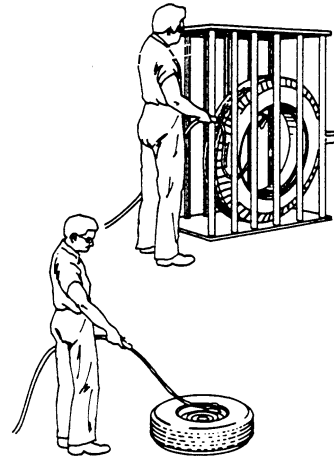

- Use a safety cage if available.
- Do not stand over tire. Use a clip-on chuck and extension hose.

7.12.1.2 Wheel Nut Torque

At first use, or when a wheel is removed, check drive wheel nut torque every 15 minutes on the road or 1 hour in the field until the specified torque is maintained. Continue with a checking schedule of 10 and 50 hours (field or road operation), and then every 200 hour intervals thereafter.

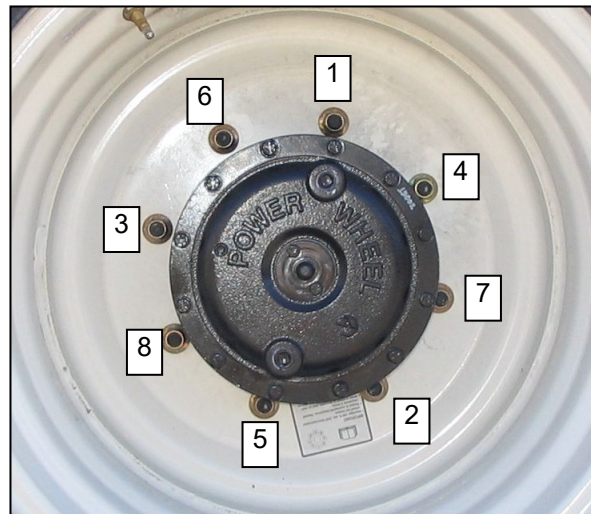

- a. Tighten nuts to 220 ft-lbf (300 N·m) using the tightening sequence as shown.

NOTE

To avoid damage to wheel rims, do not over-tighten wheel nuts.

- b. Repeat sequence three times.

MAINTENANCE/SERVICE

7.12.1.3 Lubricant

The drive wheel gearbox lubricant should be changed after the first 50 hours. Check the level every 200 hours or annually and change every 1000 hours. The windrower should be on level ground when checking lubricant level.

- a. Check the lubricant as follows:

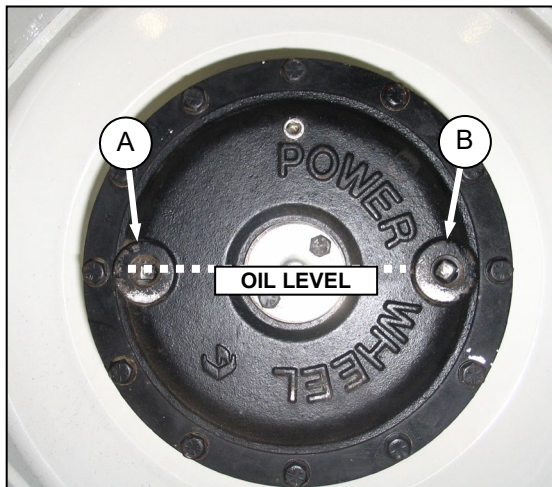

1. Rotate wheel so that one of the plugs (A) is horizontally aligned with the center of the hub.
2. Remove the plug. The oil should be visible through the hole or slightly running out.

NOTE

Type of lubricant used after first lubricant change is different from factory supplied lubricant.

3. If lubricant needs to be added, remove the second plug (B), and add lubricant until lubricant runs out at (A). Prior to first change, use SAE 85W-140, API Service, Class GL-5, Extreme Pressure Gear Lubricant. After first change, use SAE 75W-90, API Service, Class GL-5, Fully Synthetic Transmission Lubricant (SAE J2360 preferred).
4. Replace plugs and tighten.

- b. Change the lubricant as follows:

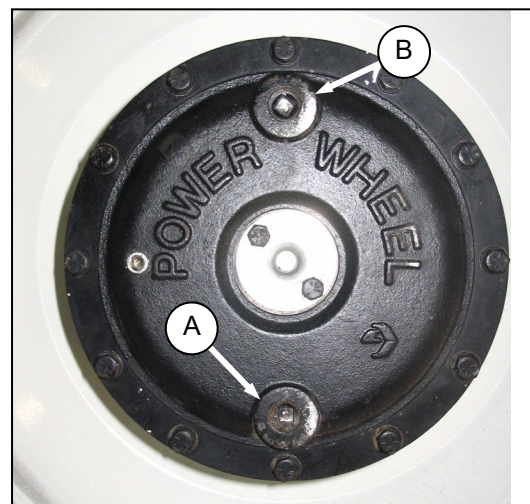

1. Rotate the wheel so that one of the plugs (A) is located at the bottom.
2. Place a large enough container (about 2 quarts U.S. (2 litres) under the drain plug (A).
3. Remove top plug (B) and drain lubricant. Ideally, the lubricant should be at operating temperature for good draining.
4. When lubricant has drained, rotate wheel so that one of the plugs (A) is horizontally aligned with the center of the hub. See illustration opposite.

NOTE

Type of lubricant used after first lubricant change is different from factory supplied lubricant.

5. Add lubricant through (A) until lubricant runs out of hole at (B). Use SAE 75W-90, API Service, Class GL-5, Fully Synthetic Transmission Lubricant (SAE J2360 preferred). Drive wheel gearbox capacity is 1.5 qts. U.S. (1.4 litres).
6. Replace both plugs and tighten.

MAINTENANCE AND SERVICE

7.12.1.4 Drive Wheel Removal/Installation



DANGER

To avoid severe personal injury or death caused by machine runaway, shut off engine and remove key before performing any of the following checks and/or adjustments.

- Remove header.
- Park windrower on level ground and block all wheels.
- Place GSL in N-DETENT, shutdown engine and remove key.

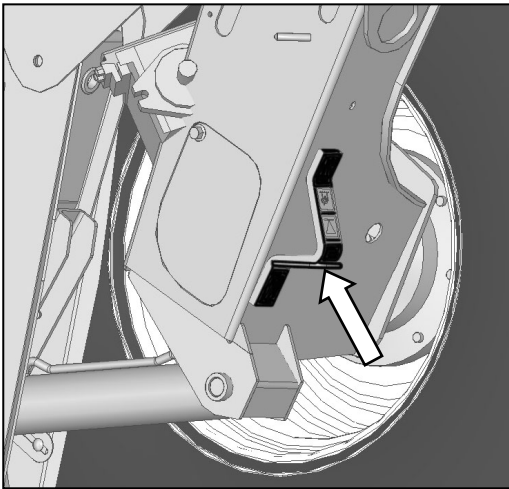

- Jack up windrower under leg jack point and raise windrower wheel slightly off ground.

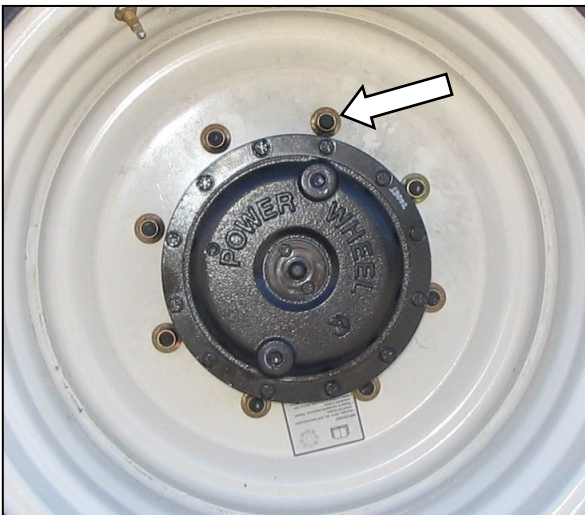

- Undo wheel nuts and remove wheel.

- To install new tire, ensure that air valves are on outside and tire tread point forward. For "Turf" tires (diamond tread), be sure arrow on sidewall points in forward rotation.

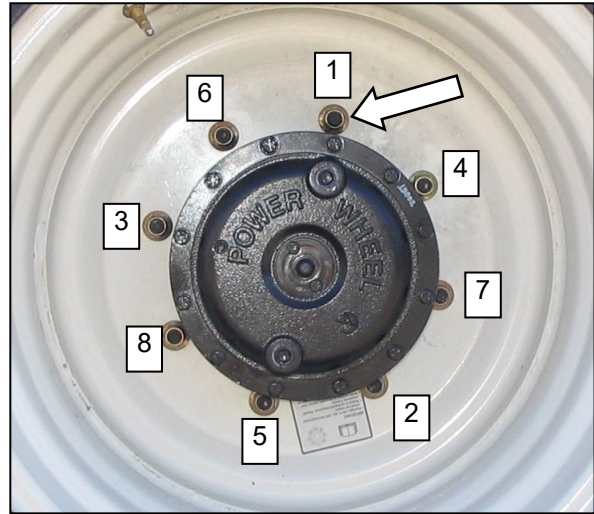

- Position wheel on hub and install wheel nuts.
- Tighten nuts to 220 ft·lbf (300 N·m) using the tightening sequence as shown.

NOTE

To avoid damage to wheel rims, do not over-tighten wheel nuts.

- Repeat sequence three times.
- Lower windrower and remove jack.

MAINTENANCE/SERVICE

7.12.2 CASTER WHEELS

7.12.2.1 Tire Inflation

- a. Visually check daily that tires have not lost pressure. Under-inflation of drive tires can cause side wall cracks.



DANGER

To avoid severe personal injury or death caused by machine runaway, shut off engine and remove key before performing any of the following checks and/or adjustments.

- b. Measure tire pressure annually with a gauge. Maintain the pressure at 10 psi (69 kPa).

NOTE

If caster wheels shimmy, a possible cause is over-inflation.



DANGER

- Never install a tube in a cracked wheel rim.
- Never weld a wheel rim.
- Make sure all the air is removed from a tire before removing the tire from the rim.
- Never use force on an inflated or partially inflated tire. Make sure the tire is correctly seated before inflating to operating pressure.
- Do not remove, install or make repairs to a tire on a rim unless you have the proper equipment and experience to perform the job. Take the tire and rim to a qualified tire repair shop.
- If the tire is not in correct position on the rim, or if too full of air, the tire bead can loosen on one side, causing air to leak at high speed and with great force. An air leak of this nature can thrust the tire in any direction, endangering anyone in the area.

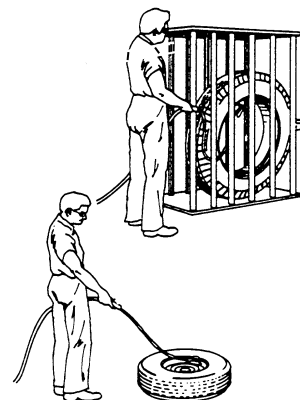

- Use a safety cage if available.
- Do not stand over tire. Use a clip-on chuck and extension hose.

MAINTENANCE AND SERVICE

7.12.2.2 Ballast Requirements

Fluid ballasting of rear caster tires is recommended to provide adequate machine stability when using large headers on the windrower. Also, the stability of machine varies with different attachments, windrower options, terrain and operator's driving technique.

Ballast capability per tire is at a maximum fill of 75% or when fluid is level with valve stem when the stem is positioned at 12 o'clock. Fluid can be added to any level up to maximum fill and always add an equal amount of fluid on both sides.

| TIRE SIZE | FLUID PER TIRE AT 75% FILL U.S. Gal. (Liters) | TOTAL WEIGHT OF BOTH TIRES lb (kg) * |
|------------------|--|---|
| 7.5X16 (A) | 10 (38) | 200 (91) |
| 10X16 (B) | 18 (69) | 380 (170) |
| 16.5X16.1 (C) | 41 (158) | 830 (377) |

* Weights are given for typical calcium chloride and water mixtures. Weight is reduced by 20% if only water is used (for areas that do not require anti-freeze protection).

| HEADER DESCRIPTION | | RECOMMENDED BALLAST | | | | RECOMMENDED TIRE SIZE |
|-------------------------------|--|---------------------|------------|--------------------|------------|----------------------------------|
| | | LEVEL GROUND | | HILLS | | |
| TYPE | SIZE | PER TIRE | BOTH TIRES | PER TIRE | BOTH TIRES | |
| | | U.S. Gal. (Liters) | lb (kg) * | U.S. Gal. (Liters) | lb (kg) * | |
| A, D, R Series All Options | 25' and Down | 0 | 0 | 0 | 0 | A,B,C |
| D Series | 30' Single or Split Reel W/O Conditioner. 35' Single Reel | 0 | 0 | 10 (38) | 200 (91) | A,B,C |
| | 30' Split Reel. Steel Fingers & Conditioner. 35' Split Reel (5 or 6 Bat) | 18 (69) | 380 (170) | 30 (115) | 630 (288) | Level Ground – B, C Hills - C |
| | 40' | 30 (115) | 630 (288) | 41 (158) | 830 (377) | C |

* If only water is used, increase volume of water by 20% (up to maximum allowable fill per tire) to compensate.

MAINTENANCE/SERVICE

7.12.2.3 Wheel Nut Torque

At first use, or when a wheel is removed, check caster wheel bolt torque as follows after 5 hours and then at 200 hour intervals:

NOTE

To avoid damage to wheel rims, do not over-tighten wheel nuts.

Forked Casters

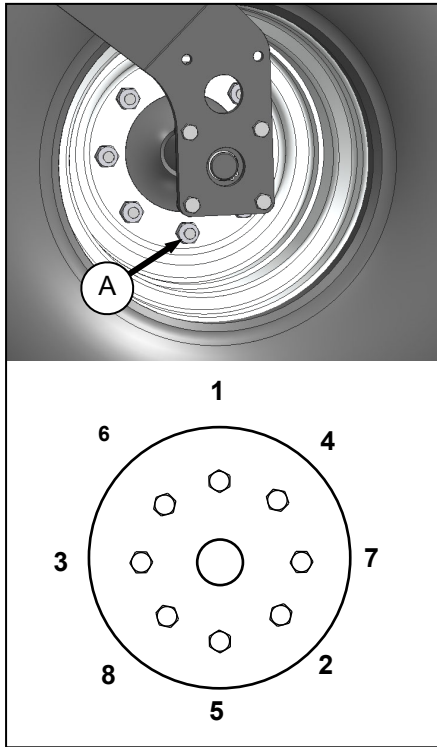

- Tighten nuts (A) to 120 ft·lbf (163 N·m) using the tightening sequence as shown.
- Repeat sequence three times.

Formed Casters

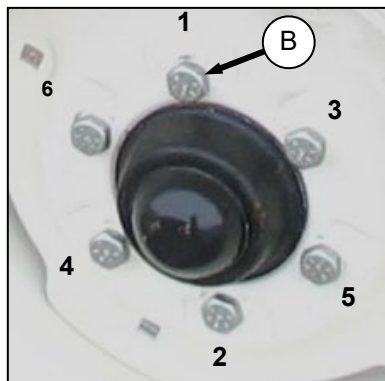

- Tighten nuts (B) to 120 ft·lbf (163 N·m) using the tightening sequence as shown.
- Repeat sequence three times.

7.12.2.4 Forked Caster Wheel Removal/Installation



DANGER

To avoid severe personal injury or death caused by machine runaway, shut off engine and remove key before performing any of the following checks and/or adjustments.

- Remove the caster wheel as follows:
 - Park windrower on level ground and block all wheels.
 - Place GSL in N-DETENT, shutdown engine and remove key.
 - Raise end of walking beam using a jack (4000 lb (1816 kg)) capacity or other suitable lifting device until the wheel is slightly off the ground.

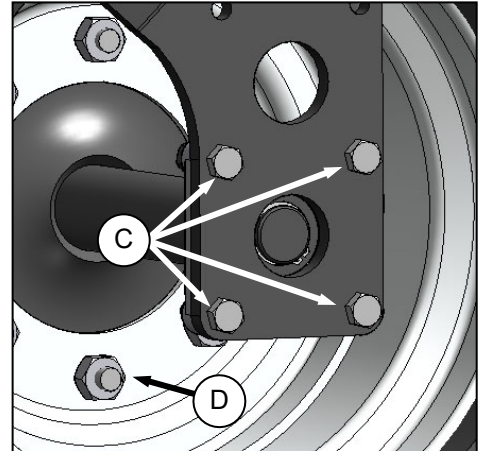

- Remove the eight bolts (C) attaching axle to forked caster and remove wheel assembly from caster.
 - Undo the eight wheel nuts (D) and remove wheel from axle.
- Install the caster wheel as follows:
 - Position wheel on axle and install wheel nuts (D).
 - Torque nuts (D) as specified in previous section. Refer to Section 7.12.2.3, Wheel Nut Torque.
 - Position wheel assembly in forked caster and install with bolts (C). Torque bolts to 75-79 ft·lbf (97-107 N·m).
 - Lower windrower and remove jack.

MAINTENANCE AND SERVICE

7.12.2.5 Formed Caster Wheel Removal/Installation



DANGER

To avoid severe personal injury or death caused by machine runaway, shut off engine and remove key before performing any of the following checks and/or adjustments.

- a. Remove the caster wheel as follows:
 1. Park windrower on level ground and block all wheels.
 2. Place GSL in N-DETENT, shutdown engine and remove key.
 3. Raise end of walking beam using a jack (4000 lb (1816 kg)) capacity or other suitable lifting device until the wheel is slightly off the ground.



4. Undo the six wheel bolts (A) and remove wheel from hub.
- b. Install the caster wheel as follows:
 1. Position wheel on hub and install wheel bolts (A).
 2. Torque nuts (E) to 120 ft·lbf (163 N·m) using the tightening sequence as shown on previous page.
 3. Lower windrower and remove jack.

7.12.2.6 Caster Wheels Anti-Shimmy Dampeners

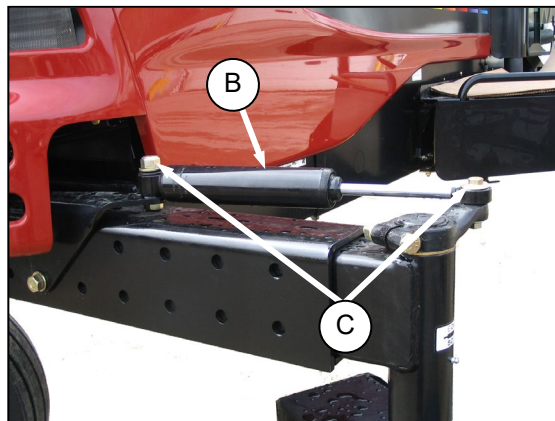

Each caster is equipped with a fluid filled anti-shimmy dampener (B). The mounting bolts (C) need to be checked periodically for security. Refer to Section 7.13, MAINTENANCE SCHEDULE. Inboard bolt should be tightened to 100 ft·lbf (135 N·m). Outboard bolt should be tightened to 85 ft·lbf (115 N·m).

MAINTENANCE/SERVICE

7.13 MAINTENANCE SCHEDULE

The maintenance schedule (see next page) specifies the periodic maintenance procedures and service intervals. Regular maintenance is the best insurance against early wear and untimely breakdowns. Following this schedule will increase machine life. For detailed instructions, refer to Section 7 MAINTENANCE AND SERVICE. Use the fluids and lubricants specified in Section 7.3.1, Recommended Fuel, Fluids and Lubricants.

Service Intervals: The recommended service intervals are in hours of operation. Where a service interval is given in more than one time frame, e.g. "100 hours or Annually", service the machine at whichever interval is reached first.

IMPORTANT

Recommended intervals are for average conditions. Service the machine more often if operated under adverse conditions (severe dust, extra heavy loads, etc.).



CAUTION

Carefully follow safety messages given under Section 7.1 PREPARATION FOR SERVICING, and Section 7.2 RECOMMENDED SAFETY PROCEDURES.

7.13.1 BREAK-IN INSPECTION

| <u>BREAK-IN INSPECTIONS</u> | | |
|------------------------------------|---|--|
| HRS | ITEM | CHECK |
| Every .25 Road or 1 in Field | Drive Wheel Nuts | Torque – 220 ft·lbf (300 N·m) Repeat Checks Until Torque Stabilizes. |
| 5 | A/C Belt | Tension |
| | Caster Wheel Nuts | Torque – 120 ft·lbf (163-172 N·m) |
| | Caster Wheel Anti-Shimmy Dampener Bolts | Inboard Bolt Torque – 100 ft·lbf (135 N·m) Outboard Bolt Torque – 85 ft·lbf (115 N·m) |
| | Walking Beam Width Adjustment Bolts | Torque – 330 ft·lbf (448 N·m) |
| 10 | Walking Beam Width Adjustment Bolts | Torque – 330 ft·lbf (448 N·m) |
| | Drive Wheel Nuts | Torque – 220 ft·lbf (300 N·m) Repeat Checks at 20 and 30 hours. |
| | Neutral | Dealer Adjust |
| 50 | Hose Clamps – Air Intake/Radiator/Heater/Hydraulic | Hand Tighten Unless Otherwise Noted. |
| | Walking Beam Width Adjustment Bolts | Torque – 330 ft·lbf (448 N·m) |
| | Caster Wheel Anti-Shimmy Dampener Bolts | Inboard Bolt Torque – 100 ft·lbf (135 N·m) Outboard Bolt Torque – 85 ft·lbf (115 N·m) |
| | Drive Wheel Nuts | Torque 220 ft·lbf (300 N·m) Repeat Checks Until Torque Stabilizes. |
| | Drive Wheel Lubricant | Change |
| | Main Gearbox Oil | Change |
| | Charge System Hydraulic Oil Filter | Change |
| Return Oil Filter (if applicable) | Change | |

MAINTENANCE AND SERVICE

7.13.2 INTERVAL MAINTENANCE

| <i>INTERVAL</i> | <i>SERVICE</i> |
|--------------------------------|--|
| FIRST USE | Refer To BREAK-IN INSPECTIONS (previous page). |
| ANNUALLY * | <ol style="list-style-type: none"> 1. Change Fuel Tank Vent Line Filter. 2. Check Battery Fluid Level. 3. Check Battery Charge. 4. Check Anti-Freeze Concentration. 5. Cycle A/C Blower Switch To Distribute Refrigerant Oil. 6. Check Steering Control Linkages. |
| END OF SEASON | Refer To Section 6.3.9 STORAGE. |
| 10 HOURS OR DAILY | <ol style="list-style-type: none"> 1. Check Tire Inflation. 2. Check Engine Oil Level. 3. Check Engine Coolant Level At Reserve Tank. 4. Clean Radiator, Hydraulic Oil Cooler, Charge Air Cooler, and A/C Condenser. 5. Check Hydraulic Oil Level. 6. Drain Fuel Filter Water Trap. 7. Fill Fuel Tank. 8. Check Hydraulic Hoses and Lines For Leaks. |
| 50 HOURS | <ol style="list-style-type: none"> 1. Grease Caster Pivots. 2. Grease Walking Beam Center Pivot. 3. Grease Top Lift Link Pivots. 4. Grease Forked Caster Spindle Bearings. 5. Clean Cab Fresh Air Intake Filter. 6. Check Gear Box Oil Level. |
| 100 HOURS OR ANNUALLY * | <ol style="list-style-type: none"> 1. Clean Cab Air Return Filter. |
| 200 HOURS OR ANNUALLY * | <ol style="list-style-type: none"> 1. Check Drive Wheel Lubricant Level. 2. Grease Formed Caster Wheel Hub Bearings. 3. Check Wheel Nut Torque. |
| 500 HOURS | <ol style="list-style-type: none"> 1. Change Engine Oil and Filter (or Annually). 2. Change Fuel Filters. 3. Change Gearbox Lubricant. 4. Change Charge System and Return (if applicable) Hydraulic Oil Filters. 5. Check Safety Systems (or Annually). |
| 1000 HOURS | <ol style="list-style-type: none"> 1. Change Engine Air Cleaner Filter Element. 2. Change Drive Wheel Lubricant. 3. Check Engine Valve Tappet Clearance. |
| 1500 HOURS | <ol style="list-style-type: none"> 1. Change Hydraulic Oil. 2. Change Lift Filter. |
| 2000 HOURS | <ol style="list-style-type: none"> 1. Perform General Engine Inspection. 2. Change Engine Coolant. |

* IT IS RECOMMENDED THAT ANNUAL MAINTENANCE BE DONE PRIOR TO START OF OPERATING SEASON.

MAINTENANCE/SERVICE

WINDROWER Serial NO. _____

Combine this record with the record in the Header Operator's Manual.
Refer to Section 7, MAINTENANCE AND SERVICE for details on each maintenance procedure.
Copy this page to continue record.

| ACTION: | | ✓ - Check | ⬇ - Lubricate | ▲ - Change | * - Clean | + - Add | | | | | | | | | | | | | | | | |
|------------------------------|----------------------------------|--|---------------|------------|-----------|---------|--|--|--|--|--|--|--|--|--|--|--|--|--|--|--|--|
| MAINTENANCE RECORD | Hour Meter Reading | | | | | | | | | | | | | | | | | | | | | |
| | Date | | | | | | | | | | | | | | | | | | | | | |
| | Serviced By | | | | | | | | | | | | | | | | | | | | | |
| FIRST USE | | Refer to 7.14.1 Break-In Inspections. | | | | | | | | | | | | | | | | | | | | |
| 10 HOURS OR DAILY | | NOTE: A RECORD OF DAILY MAINTENANCE IS NOT NORMALLY REQUIRED BUT IS AT THE OWNER/OPERATOR'S DISCRETION. | | | | | | | | | | | | | | | | | | | | |
| * | A/C Condenser | | | | | | | | | | | | | | | | | | | | | |
| * | Charge Air Cooler | | | | | | | | | | | | | | | | | | | | | |
| ✓ | Engine Oil Level | | | | | | | | | | | | | | | | | | | | | |
| ✓ | Engine Coolant Level | | | | | | | | | | | | | | | | | | | | | |
| ✓ | Fuel Tank | | | | | | | | | | | | | | | | | | | | | |
| ✓ | Fuel Filter Water Trap | | | | | | | | | | | | | | | | | | | | | |
| ✓ | Hydraulic Hoses and Lines | | | | | | | | | | | | | | | | | | | | | |
| * | Hydraulic Oil Cooler | | | | | | | | | | | | | | | | | | | | | |
| ✓ | Hydraulic Oil Level | | | | | | | | | | | | | | | | | | | | | |
| * | Radiator | | | | | | | | | | | | | | | | | | | | | |
| ✓ | Tire Inflation | | | | | | | | | | | | | | | | | | | | | |
| ANNUALLY | | | | | | | | | | | | | | | | | | | | | | |
| ✓ | A/C Blower | | | | | | | | | | | | | | | | | | | | | |
| ✓ | Anti-Freeze Concentration | | | | | | | | | | | | | | | | | | | | | |
| ✓ | Battery Charge | | | | | | | | | | | | | | | | | | | | | |
| ✓ | Battery Fluid Level | | | | | | | | | | | | | | | | | | | | | |
| ▲ | Fuel Tank Vent Line Filter | | | | | | | | | | | | | | | | | | | | | |
| ✓ | Steering Linkages | | | | | | | | | | | | | | | | | | | | | |
| 50 HOURS | | | | | | | | | | | | | | | | | | | | | | |
| * | Cab Fresh Air Intake Filter | | | | | | | | | | | | | | | | | | | | | |
| ⬇ | Caster Pivots | | | | | | | | | | | | | | | | | | | | | |
| ⬇ | Forked Caster Spindle Bearings | | | | | | | | | | | | | | | | | | | | | |
| ✓ | Gear Box Oil Level | | | | | | | | | | | | | | | | | | | | | |
| ⬇ | Top Lift Link Pivots | | | | | | | | | | | | | | | | | | | | | |
| ⬇ | Walking Beam Center Pivot | | | | | | | | | | | | | | | | | | | | | |
| 100 HOURS OR ANNUALLY | | | | | | | | | | | | | | | | | | | | | | |
| * | Cab Air Return Filter | | | | | | | | | | | | | | | | | | | | | |
| 200 HOURS OR ANNUALLY | | | | | | | | | | | | | | | | | | | | | | |
| ⬇ | Formed Caster Wheel Hub Bearings | | | | | | | | | | | | | | | | | | | | | |
| ✓ | Drive Wheel Lubricant | | | | | | | | | | | | | | | | | | | | | |
| ✓ | Wheel Nut Torque | | | | | | | | | | | | | | | | | | | | | |

Continued Next Page

MAINTENANCE AND SERVICE

| ACTION: | | ✓ - Check | ⬇ - Lubricate | ▲ - Change | * - Clean | + - Add | | | | | | | | | | | | | | | | |
|---------------------------|--|-----------|---------------|------------|-----------|---------|--|--|--|--|--|--|--|--|--|--|--|--|--|--|--|--|
| MAINTENANCE RECORD | Hour Meter Reading | | | | | | | | | | | | | | | | | | | | | |
| | Date | | | | | | | | | | | | | | | | | | | | | |
| | Serviced By | | | | | | | | | | | | | | | | | | | | | |
| 500 HOURS | | | | | | | | | | | | | | | | | | | | | | |
| ▲ | Engine Oil and Filter (or Annually) | | | | | | | | | | | | | | | | | | | | | |
| ▲ | Fuel Filters | | | | | | | | | | | | | | | | | | | | | |
| ▲ | Gearbox Lubricant | | | | | | | | | | | | | | | | | | | | | |
| ▲ | Charge System and Return (if applicable) Hydraulic Oil Filters | | | | | | | | | | | | | | | | | | | | | |
| ✓ | Safety Systems (or Annually) | | | | | | | | | | | | | | | | | | | | | |
| 1000 HOURS | | | | | | | | | | | | | | | | | | | | | | |
| ▲ | Drive Wheel Lubricant | | | | | | | | | | | | | | | | | | | | | |
| ▲ | Engine Air Cleaner Filter Element | | | | | | | | | | | | | | | | | | | | | |
| ✓ | Engine Valve Tappet Clearance | | | | | | | | | | | | | | | | | | | | | |
| 1500 HOURS | | | | | | | | | | | | | | | | | | | | | | |
| ▲ | Hydraulic Oil | | | | | | | | | | | | | | | | | | | | | |
| ▲ | Lift Filter | | | | | | | | | | | | | | | | | | | | | |
| 2000 HOURS | | | | | | | | | | | | | | | | | | | | | | |
| ▲ | Engine Coolant | | | | | | | | | | | | | | | | | | | | | |
| ✓ | General Inspection | | | | | | | | | | | | | | | | | | | | | |

TROUBLESHOOTING

8 TROUBLESHOOTING

8.1 ENGINE

| SYMPTOM | PROBLEM | SOLUTION | SECTION | |
|--|--------------------------|---|--|--------------------|
| Engine Hard To Start or Will Not Start. | Controls not in neutral. | Move GSL to neutral. | 6.3.5.1 | |
| | | Move steering wheel to locked position. | | |
| | | | Disengage header clutch. | 5.17.1 |
| | | Neutral interlock misadjusted. | Contact MacDon dealer. | * |
| | | No fuel to engine. | Fill empty fuel tank, replace clogged filter. | 6.3.5.5 7.8.6.2 |
| | | Old fuel in tank. | Drain tank, refill with fresh fuel | 7.8.6 |
| | | Water, dirt or air in fuel system. | Drain, flush, fill and prime system. | |
| | | Improper type of fuel. | Use proper fuel for operating conditions. | 7.3.1.1 |
| | | Crankcase oil too heavy. | Use recommended oil. | 7.3.1.3 |
| | | Low battery output. | Have battery tested. Check battery electrolyte level. | 7.10.1.1 |
| | | Poor battery connection. | Clean and tighten loose connections. | |
| | | Faulty starter. | Contact MacDon dealer. | * |
| | | Wiring shorted, circuit breaker open. | Check continuity of wiring and breaker (manual reset). | 7.10.13.1 |
| | | Loose electrical connection at fuel pump. | Ensure connector at pump is fully pushed in. | - |
| | Engine Knocks. | Insufficient oil. | Add oil. | 7.8.3 |
| Engine out of time. | | Contact MacDon dealer. | * | |
| Low or high coolant temperature. | | Remove and check thermostat. See "Engine Overheats". | ** | |
| Improper fuel. | | Use proper fuel. | 7.3.1.1 | |
| Low Oil Pressure. | Low oil level. | Add oil. | 7.8.3 | |
| | Improper type of oil. | Drain, fill crankcase with proper oil. | 7.8.4 | |
| | Worn components. | Contact MacDon dealer. | * | |
| High Oil Consumption. | Crankcase oil too light. | Use recommended oil. | 7.3.1.3 | |
| | Oil leaks | Check for leaks around gaskets, seals, and drain plugs. | 7.8.4 | |
| | Internal parts worn. | Contact MacDon dealer. | * | |

* See your MacDon dealer

** Refer to Windrower Technical Manual

TROUBLESHOOTING

| SYMPTOM | PROBLEM | SOLUTION | SECTION |
|--|--|--|--------------------|
| Engine Runs Irregularly or Stalls Frequently. | Unsteady fuel supply. | Change filter on fuel tank vent line. Replace clogged fuel filter. | 7.8.6.1 7.8.6.2 |
| | Water or dirt in fuel system. | Drain, flush, and fill system. | 7.8.6.3 |
| | Air in fuel system. | Contact MacDon dealer. | * |
| | Low coolant temperature. | Remove and check thermostat. | ** |
| | Dirty or faulty injectors. | Contact MacDon dealer. | * |
| Lack Of Power. | Incorrect timing. | Contact MacDon dealer. | * |
| | Engine oil viscosity too high. | Use recommended oil. | 7.3.1.3 |
| | Intake air restriction. | Service air cleaner. | 7.8.5.1 |
| | Clogged fuel filter. | Replace primary fuel filter and if necessary, replace secondary fuel filter. | 7.8.6.2 |
| | High back pressure. | Clean out muffler. | 7.8.9 |
| | Improper type of fuel. | Use proper fuel. | 7.3.1.1 |
| | High or low engine temperature. | Remove and check thermostat. See "Engine Overheats". | ** |
| | Improper valve clearance. Faulty injectors. | Contact MacDon dealer. | * |
| Engine Temperature Below Normal. | Defective thermostat. | Remove and check thermostat. | * |
| Warning Alarm Sounds. | Engine overheated. | Check coolant level. | 7.8.7 |
| | | Check thermostat. | ** |
| | Low engine oil pressure. | Check oil level. | 7.8.3 |
| | Low transmission oil pressure. | | 7.11.1 |
| Engine Overheats. | Low coolant level. | Fill reserve tank to proper level. Check system for leaks. | 7.8.7 |
| | Engine overloaded. | Reduce ground speed. | 6.3.6 |
| | Defective radiator cap. | Replace cap. | 7.8.7.2 |
| | Defective fan belt. | Replace belt. | 7.8.10.3 |
| | Dirty radiator screen: • Rotors turning | Check for obstructions in ducting from screen to fan shroud. | 7.9.1 |
| | | | |
| | Dirty radiator core. | Clean radiator. | 7.9.3 |
| | Cooling system dirty. | Flush cooling system. | |
| | Defective thermostat. | Remove and check thermostat. | ** |
| | Defective temperature gauge or sender. | Check coolant temperature with thermometer, replace gauge if necessary. | * |
| | Defective water pump. | Contact MacDon dealer. | * |
| | Water only for coolant. | Replace with antifreeze. | 7.8.7 |

(continued next page)

* See your MacDon dealer

** Refer to Windrower Technical Manual

TROUBLESHOOTING

| SYMPTOM | PROBLEM | SOLUTION | SECTION |
|---|--|---|----------|
| High Fuel Consumption. | Improper type of fuel. | Use proper fuel. | 7.3.1.1 |
| | Clogged or dirty air cleaner. | Service air cleaner. | 7.8.5.1 |
| | Engine overloaded. | Reduce ground speed. | 6.3.6 |
| | Improper valve clearance. | Reset valves. | * |
| | Engine out of time. | Contact MacDon dealer. | * |
| | Low engine temperature. | Check thermostat. | ** |
| | Injection nozzles dirty. | Contact MacDon dealer. | * |
| Engine Emits Black or Grey Exhaust. | Improper type of fuel. | Consult your fuel supplier and use proper type fuel for conditions. | 7.3.1.1 |
| | Engine overloaded. | Reduce ground speed. | 6.3.6 |
| | Clogged or dirty air cleaner. | Service air cleaner. | 7.8.5.1 |
| | Defective muffler. | Check muffler for possible damage which might create back pressure. | 7.8.9 |
| | Dirty or faulty injectors. | Contact MacDon dealer. | * |
| | Engine out of time. | | |
| | Air in fuel system. | | |
| Engine Emits White Exhaust. | Improper type of fuel. | Consult your fuel supplier and use proper type fuel for conditions. | 7.3.1 |
| | Cool engine. | Warm engine up to normal operating temperature. | 6.3.5.2 |
| | Defective thermostat. | Remove and check thermostat. | ** |
| | Engine out of time. | Contact MacDon dealer. | * |
| Starter Cranks Slowly or Will Not Operate. | Low battery output. | Check battery charge. | 7.10.1.1 |
| | Controls not in neutral. | Move GSL to neutral. | 6.3.6 |
| | | Move steering wheel to center position. | 6.3.5.1 |
| | | Disengage header. | 5.17.1 |
| | Relay not functioning. | Check relay and wire connections. | 7.10.13 |
| | Loose or corroded battery connections. | Clean and tighten loose connections. | 7.10.1.5 |
| | Key switch worn or terminals loose. | Contact MacDon dealer. | * |
| | Crankcase oil too high viscosity. | Use recommended oil. | 7.3.1.3 |
| | Main fuse defective/blown. | Replace main fuse. | 7.10.13 |
| | Key power fuse blown. | Replace | |
| Switch at interlock not closed or defective. | Adjust switch or replace. | * | |
| Air Filters Require Frequent Cleaning. | Vacuator plugged. | Clean out vacuator. | 7.8.5.1 |
| | Pre-cleaner rotor not turning freely. | Repair/replace. | 7.9.1 |

* See your MacDon dealer

** Refer to Windrower Technical Manual

TROUBLESHOOTING

8.2 ELECTRICAL

| SYMPTOM | PROBLEM | SOLUTION | SECTION |
|--|--|--|------------------|
| Low Voltage and/or Battery Will Not Charge. | Defective battery. | Have battery tested. | 7.10.1.4 |
| | Defective alternator belt. | Replace worn belt. | 7.8.10.3 |
| | Loose or corroded connections. | Clean and tighten battery connections. | 7.10.1.4 |
| | Dirty or defective alternator, defective voltage regulator, or high resistance in circuit. | Contact MacDon dealer. | * |
| | Alternator or voltage regulator not connected properly. | Connect properly. | 7.10.1.7 |
| Lights Dim. | High resistance in circuit or poor ground on lights. | Check the wiring circuit for a break in a wire or a poor ground. | --- |
| | Defective light switch. | Contact MacDon dealer. | * |
| Lights Do Not Light. | Burnt out light bulb | Replace light bulb | 7.10.2 to 7.10.9 |
| | Defective light switch. | Contact MacDon dealer. | * |
| | Broken wiring. | Check wiring for broken wire or shorts. | --- |
| | Open or defective circuit breaker. | Check circuit breaker | 7.10.13.1 |
| | Defective relay. | Replace relay. | |
| | Poor ground on lights. | Clean and tighten ground wires. | --- |
| Turn Signals or Indicators Showing Wrong Direction. | Reversed wires. | Contact MacDon dealer. | * |
| No Current To Cab. | Circuit breaker tripped. | Breaker automatically resets. | --- |
| | Broken or disconnected wire. | Contact MacDon dealer. | * |
| | Battery disconnect switch is off. | Turn on switch. | 7.10.2 |

8.3 HYDRAULICS

| SYMPTOM | PROBLEM | SOLUTION | SECTION |
|--|---|--|---------------------|
| Header or Reel Not Lifting. | Contaminant in relief valve. | Clean relief valve at cylinder control valve. | ** |
| | Appropriate solenoids not being energized by activating switch. | Contact MacDon dealer. | * |
| Header or Reel Lifts But Lacks Power. | Relief pressure too low or contaminant in relief valve. | Check/adjust/clean relief valve at cylinder control valve. | ** |
| Reel and/or Conveyor Not Turning. | Header drive switch not engaged. | Engage switch. | 5.17.1 |
| | Flow controls adjusted too low. | Toggle speed controls on CDM to increase flow. | 6.5.6, 6.5.7, 6.6.4 |
| | Appropriate solenoid on flow control block not being energized. | Contact MacDon dealer. | * |
| Reel and/or Conveyor Turns But Lacks Power. | Relief pressure too low. | Check/adjust/clean relief valve. | ** |
| Hydraulic Oil Hi-Temp Alarm. | Hydraulic oil cooling system not working properly. | Check/clean cooling box. | |
| | Faulty bypass valve. | Clean or replace. | * |
| Hydraulic Oil Lo-Temp Alarm. | Hydraulic oil too cold. | Run engine until hydraulic oil warms up. | |

* See your MacDon dealer

** Refer to Windrower Technical Manual

TROUBLESHOOTING

8.4 HEADER DRIVE

| SYMPTOM | PROBLEM | SOLUTION | SECTION |
|----------------------------|--|---|---------|
| Header Drive Not Engaging. | Header drive switch in cab not engaged. | Engage switch. | 5.17.1 |
| | Appropriate solenoid not being energized by activating switch. | Contact MacDon dealer. | * |
| | Operator presence switch not closed or faulty. | Occupy operator's seat or replace switch. | * |
| Header Drive Lacks Power. | Header drive overload. | Reduce ground speed. | 6.3.6 |
| | Relief valve setting too low. | Contact MacDon dealer. | * |
| Warning Alarm Sounds. | Header drive overload. | Reduce ground speed. | 6.3.6 |
| | Relief valve setting too low. | Contact MacDon dealer. | * |

8.5 TRACTION DRIVE

| SYMPTOM | PROBLEM | SOLUTION | SECTION |
|---|---|--|---------------|
| Warning Alarm Sounds and Transmission Oil Light Is On. | Low hydraulic oil level. | Stop engine and add oil to hydraulic system. | 7.11.1 |
| | Low hydraulic pressure. | Contact MacDon dealer. | * |
| | Foreign material shorting sender. | | |
| | Short in alarm wiring. | | |
| | Faulty sender. | | |
| Wheels Lack Pulling Ability On A Grade or Pulling Out Of A Ditch. | Insufficient torque at drive wheels. | Move speed-range control to field position and reduce ground speed. | 6.3.6 |
| | Loose or worn controls. | Check controls. | 7.7.3 |
| | Air in system. | Use proper oil. | 7.3.1.3 |
| | | Check oil level, and leaks. | 7.11.1 |
| | Brakes binding or not releasing fully. | Check hydraulic oil filters. | 7.11.4 |
| | | Check pressure (min. 200 psi (1379 kPa)) on brake release valve. | ** |
| | | Contact MacDon dealer. | * |
| Relief valve in tandem pump dirty or damaged. | Replace relief valve. | ** | |
| Both Wheels Will Not Pull In Forward or Reverse. | Low oil level. | Check oil reservoir level. | 7.11.1 |
| | Power hubs disengaged. | Engage power hubs. | 6.3.8.3 |
| | Damaged hydraulic lines preventing proper oil flow. | Replace damaged lines. | * |
| | Steering controls worn or defective. | Check GSL and steering for loose, worn or damaged ball joints and connecting rods. | 7.7.3 & 7.7.4 |
| | Speed-range control not working. | Contact MacDon dealer. | * |
| | Pump arms have broken shaft or loose hardware. | Repair or tighten. | ** |
| | Brakes binding or not releasing fully. | Check pressure (min. 200 psi (1379 kPa)) on brake release valve. | ** |

(continued next page)

* See your MacDon dealer

** Refer to Windrower Technical Manual

TROUBLESHOOTING

| SYMPTOM | PROBLEM | SOLUTION | SECTION |
|---|--|--|---------------|
| | Charge pressure relief valve misadjusted or damaged. | Check the valve adjustment. Check valve parts and seat. | 7.11.6.2 |
| | Failed pump or motor. | Contact MacDon dealer. | * |
| One Wheel Does Not Pull In Forward or Reverse. | One final drive disengaged. | Engage final drive. | 6.3.8.3 |
| | Pump arm or shaft are broken. | Contact MacDon dealer. | * |
| | Steering controls worn or defective. | Check GSL and steering for loose, worn or damaged ball joints and connecting rods. | 7.7.3 & 7.7.4 |
| | Damaged hydraulic lines preventing proper oil flow. | Contact MacDon dealer. | * |
| | Brakes binding or not releasing fully. | Check pressure (min. 200 psi on brake release valve). | ** |
| | Speed-range control not working. | Contact MacDon dealer. | * |
| | High pressure relief valve stuck open, damaged seat. | Check valve and clean or replace. | ** |
| | Failed pump, motor or power hub. | Contact MacDon dealer. | * |
| With Steering Wheel Centered, One Wheel Pulls More Than The Other. | Leakage at pump or motor. | Contact MacDon dealer. | * |
| | Wheels not in same speed range. | | |
| | Faulty relief valve. | Repair or replace valve. | 7.11.6.2 |
| Excessive Noise From Drive System. | Hydraulic line clamps loose. | Tighten clamps. | --- |
| | Mechanical interference in steering or ground speed linkage. | Adjust, repair, replace. | 7.7.3 & 7.7.4 |
| | Brakes binding or not releasing fully. | Check pressure (min. 200 psi on brake release valve). | ** |
| | Faulty pump or motor. | Contact MacDon dealer. | * |
| | Air in system. | Check lines for leakage. | --- |
| Hydraulic Oil Filter Leaks At Seal. | Not properly tightened. | Tighten filter element. | 7.11.4 |
| | Damaged seal or threads. | Replace filter or filter head. | 7.11.4 |

8.6 STEERING AND GROUND SPEED CONTROL

| SYMPTOM | PROBLEM | SOLUTION | SECTION |
|---|--|---|--------------------|
| Machine Will Not Steer Straight. | Linkage worn or loose. | Adjust steering chain tension. Replace worn parts, adjust linkage. | 7.7.4.2 7.7.4.1 |
| Machine Moves On Flat Ground With Controls In Neutral. | Neutral interlock misadjusted. Parking brake not functioning. GSL servo misadjusted. GSL cable misadjusted. | Contact MacDon dealer. | * |
| Insufficient Road Speed. | Speed-range control in field position. | Move to road position. | 6.3.8.1 |
| Steering Wheel Will Not Lock With GSL In N-DETENT. | Transmission interlock misadjusted. | Contact MacDon dealer. | * |

(continued next page)

* See your MacDon dealer

** Refer to Windrower Technical Manual

TROUBLESHOOTING

| SYMPTOM | PROBLEM | SOLUTION | SECTION |
|--|--|-------------------------------|---------|
| Steering Wheel Will Not Unlock. | Transmission interlock cylinder not working. | Contact MacDon dealer. | * |
| Steering Is Too Stiff or Too Loose. | Steering chain tension is out of adjustment. | Adjust steering chain tension | 7.7.4.2 |

8.7 CAB AIR

| SYMPTOM | PROBLEM | SOLUTION | SECTION |
|---|--|--|-------------------|
| Blower Fan Will Not Run. | Burned out motor. Burned out switch. Motor shaft tight or bearings worn. Faulty wiring - loose or broken. Blower rotors in contact with housing. | Contact MacDon dealer. | * |
| Blower Fan Operating But No Air Coming Into Cab. | Dirty fresh air filter. | Clean fresh air filter. | 7.7.6.1 |
| | Dirty recirculating air | Clean recirculating filter | 7.7.6.2 |
| | Evaporator clogged. | Clean evaporator. | 7.7.6.4 |
| | Air flow passage blocked. | Remove blockage. | --- |
| Heater Not Heating. | Heater shut-off valve at engine closed. | Open valve. | 5.10.1. |
| | Defective thermostat in engine water outlet manifold. | Replace thermostat. | ** |
| | Heater temperature control defective. | Replace control. | |
| | No thermostat in engine water outlet manifold. | Install thermostat. | |
| Odour From Air Louvers. | Plugged drainage hose. | Blow out hose with compressed air. | --- |
| | Dirty filters. | Clean filters. | 7.7.6.1 & 7.7.6.2 |
| Air Conditioning Not Cooling. | Low refrigerant level. | Add refrigerant | * |
| | Switch contacts in thermostat burned excessively, or sensing element defective. | Replace thermostat. | ** |
| | Clutch coil burned out or disconnected. | Contact MacDon dealer. | * |
| | Condenser fins plugged. | Clean condenser. | 7.9.3 |
| | Blower motor disconnected or burned out. | Contact MacDon dealer. | * |
| | Loose or broken drive belt. | Replace drive belt and/ or tighten to specs. | 7.8.10.2 |
| | Compressor partially or completely seized. | Remove compressor for service or replacement. | ** |
| | Dirty filters. | Clean fresh air and re-circulation filters. | 7.7.6.1 & 7.7.6.2 |
| | Broken or disconnected electrical wire. | Check all terminals for loose connections; check wiring for hidden breaks. | --- |
| | Broken or disconnected ground wire. | Check ground wire to see if loose, broken, or disconnected. | |

(continued next page)

* See your MacDon dealer

** Refer to Windrower Technical Manual

TROUBLESHOOTING

| SYMPTOM | PROBLEM | SOLUTION | SECTION |
|--|---|--|-------------------|
| Air Conditioning Not Cooling. (Continued) | Expansion valve stuck in open or closed position. Broken refrigerant line. Leak in system. Compressor shaft seal leaking. Clogged screen in receiver-drier; plugged hose or coil. | Contact MacDon dealer. | * |
| Air Conditioning Not Producing Sufficient Cooling. (Sufficient Cooling Defined As When Air Temperature In Cab, Measured At Louvered Vent, Can Be Maintained At 25°F (14°C) Below Ambient Air Temperature.) | Compressor clutch slipping. | Remove clutch assembly for service or replacement. | ** |
| | Clogged air filters. | Remove air filters and clean or replace as necessary. | 7.7.6.1 & 7.7.6.2 |
| | Heater circuit is open. | Close heater valves (1 in cab, 1 at engine). | 5.10.1.1 |
| | Too little air circulation over condenser coil; fins clogged with dirt or insects. | Clean condenser. | 7.9.3 |
| | Evaporator fins clogged. | Clean evaporator fins (under cab floor). | 7.7.6.4 |
| | Too little refrigerant in system. Clogged expansion valve. Clogged receiver-drier. Excessive moisture in system. Air in system. Blower motor sluggish in operation. | Contact MacDon dealer. | * |
| | Thermostat defective or improperly adjusted. | Replace thermostat. | ** |
| Air Conditioning System Too Noisy. | Defective winding or improper connection in compressor clutch coil or relay. | Contact MacDon dealer. | * |
| | Loose or excessively worn drive belt. | Tighten or replace as required. | 7.8.10.2 |
| | Noisy clutch. | Remove clutch for service or replacement as required. | ** |
| | Noisy compressor. | Check mountings and repair. Remove compressor for service or replacement. | |
| | Compressor oil level low. | Add SP-15 PAG refrigerant oil. | |
| | Blower fan noisy due to excessive wear. | Remove blower motor for service or replacement as necessary. | * |
| | Excessive charge in system. Low charge in system. | Contact MacDon dealer. | |
| Excessive moisture in system. | Contact MacDon dealer. | | |

(continued next page)

* See your MacDon dealer

** Refer to Windrower Technical Manual

TROUBLESHOOTING

| SYMPTOM | PROBLEM | SOLUTION | SECTION |
|---|--|--|---------|
| Air Conditioning Cools Intermittently. | Compressor clutch slipping. | Contact MacDon dealer. | * |
| | Unit icing up due to: | | |
| | <ul style="list-style-type: none"> • Thermostat adjusted too low. • Excessive moisture in system. • Incorrect super-heat adjustment in expansion valve. | Adjust thermostat. | ** |
| | Thermostat defective. Defective blower switch or blower motor. Partially open, improper ground or loose connection in compressor clutch coil. | Contact MacDon dealer. | * |
| Windows Fog Up. | High humidity. | Run A/C to dehumidify air and heater to control temperature. | 5.10.3 |

8.8 OPERATOR'S STATION

| SYMPTOM | PROBLEM | SOLUTION | SECTION |
|--------------------|---|-----------------------------|--------------------|
| Rough Ride. | Seat suspension not adjusted for operator's weight. | Adjust seat suspension. | 5.3 |
| | High air pressure in tires. | Deflate to proper pressure. | 7.12.1 & 7.12.2 |

* See your MacDon dealer

** Refer to Windrower Technical Manual

OPTIONS / ATTACHMENTS

9 OPTIONS / ATTACHMENTS

9.1 COMPLETION KIT FOR AUGER & DRAPER HEADER DRIVES

Used to allow operation of a draper or auger header. Requires installation of Draper Header Reel Drive Kit (10.2), or Auger Header Drive Kit (10.3). Installation instructions are included.

9.2 COMPLETION KIT FOR DRAPER HEADER REEL DRIVE

Used together with Completion Kit for Auger & Draper Header Drives (10.1) to allow operation of a draper header. Includes reel fore-aft plumbing. Installation instructions are included.

9.3 COMPLETION KIT FOR AUGER HEADER DRIVE AND CONDITIONER REVERSER

Used together with Completion Kit for Auger & Draper Header Drives (10.1) to allow operation of an auger header. Allows the conditioner to reverse on both auger and draper headers. Installation instructions are included.

9.4 QUICK COUPLER KIT

Allows for quick removal of header hydraulics from windrower. Installation instructions are included.

9.5 DOUBLE WINDROW ATTACHMENT

Allows auger header windrower to lay a double windrow. Installation instructions are included.

9.6 BOOSTER SPRING KIT

Available for headers over 6000 lb (2724 kg). Installation instructions are included.

9.7 INTERNAL BOOSTER SPRING KIT

Internal spring for right side lift linkage to improve float capacity. Standard equipment on left side.

9.8 LIGHT HEADER FLOTATION KIT

Available for headers that do not require as much spring tension for float. Installation instructions are included.

9.9 WINDSHIELD SHADES

Retractable sun shades for front and rear windows. Installation instructions are included.

9.10 AM-FM RADIO

Available for installation into pre-wired cab. Speakers are factory installed.

Refer to M205 Self-Propelled Windrower Unloading and Assembly Instructions for installation instructions. This instruction is supplied with your windrower.

9.11 PRESSURE SENSOR KIT

Monitors hydraulic pressure and warns of overload conditions. Installation instructions are included.

9.12 WEIGHT BOX

The weight box allows engine-forward transport in high range when the header is not attached.

9.13 TOWING HARNESS

The towing harness is used together with the weight box if towing a D Series draper header behind the windrower is desired.

9.14 SWATH ROLLER

If a swath roller is desired for canola or other similar crops, an axle mounted design is recommended. Windrower can be fitted with hydraulic lift version of swath rollers featuring in console controls.

9.15 WARNING BEACONS

Roof mounted rotating warning beacons. Available with installation instructions for installation into pre-wired cab (including switch). The beacons are standard equipment for export windrowers and optional for North America.

9.16 AUTO-STEER

A MacDon approved auto-steer system is available from your dealer, who is set up to provide installation and support services.

Cabs have been prepared with "access routing knock outs" to enable easy wiring harness installation and display mounting. The GSL has been pre-wired with an auto-steer engage switch.

(continued next page)

OPTIONS / ATTACHMENTS

9.17 LIGHTING AND MARKING KIT FOR CAB-FORWARD ROAD TRAVEL

Allows the windrower to travel in the cab-forward mode on public roads and comply with vehicle lighting regulations. The kit includes red tail-lights, SMV markings, hardware, and installation instructions.

9.18 FAN AIR BAFFLE KIT

Provides a baffle to reduce windrow disturbance by air exiting the engine cooling fan.

INDEX

| | | | |
|----------------------------|----------|----------------------------|-----------------|
| Abbreviations..... | 14 | Daily check..... | 56 |
| Air Cleaner | 139 | Deck Shift Switch | 34 |
| Air Conditioning | | Definitions | 14 |
| compressor belt..... | 153 | Disc Header | |
| compressor protection..... | 27, 134 | attachment..... | 110 |
| condenser..... | 133, 158 | detaching..... | 113 |
| controls..... | 27 | disc speed set-point..... | 115 |
| evaporator..... | 133 | disc speed switch..... | 34 |
| operation..... | 134 | disc speeds..... | 52 |
| troubleshooting..... | 202 | Display | |
| Alternator..... | 165 | set-up..... | 49 |
| Antenna..... | 29 | Display Warnings..... | 44 |
| Anti-freeze..... | 117 | Double Windrowing..... | 89 |
| Attachments..... | 205 | Draper Header | |
| Auger Header | | attachment..... | 90 |
| attachment..... | 102 | deck shift..... | 101 |
| auger speed..... | 107 | detaching..... | 93 |
| detaching..... | 105 | draper speed..... | 98 |
| knife speed..... | 109 | knife speed..... | 100 |
| reel speed..... | 108 | reel speed..... | 96 |
| Auxiliary Power..... | 28 | Drapers | |
| Ballast | | speed..... | 98 |
| caster wheels..... | 189 | Drive Wheels..... | 185 |
| Battery..... | 161 | bolt torque..... | 185 |
| adding electrolyte..... | 163 | lubricant..... | 186 |
| boosting..... | 162 | removal/installation..... | 187 |
| charging..... | 162 | Driving | |
| disconnect switch..... | 161 | cab-forward..... | 64 |
| maintenance..... | 161 | engine-forward..... | 64 |
| replacement..... | 164 | reverse..... | 65 |
| Beacon | | roads..... | 69 |
| bulb replace..... | 172 | spin turn..... | 66 |
| Belts | | stopping..... | 66 |
| compressor..... | 153 | windrower..... | 61 |
| fan..... | 153 | Electrical System | |
| Bolts | | circuit breakers..... | 175 |
| torque..... | 118 | fuses..... | 175 |
| Break-In Period..... | 55 | headlight bulbs..... | 166 |
| Cab | | main fuses..... | 177 |
| air vents..... | 26 | troubleshooting..... | 199 |
| ingress/egress..... | 62 | Engine | |
| interior lighting..... | 27 | air filters..... | 139 |
| operator amenities..... | 28 | alternate speeds..... | 59 |
| radio..... | 29 | battery..... | 161 |
| Cab Air Filters | | battery maintenance..... | 161 |
| servicing..... | 132, 133 | belt replacement..... | 153 |
| Cab Display Module..... | 35, 36 | belt tension..... | 153 |
| Cab Forward..... | 63 | changing oil..... | 138 |
| Cab Temperature..... | 26 | charge air..... | 142 |
| Capacities..... | 117 | exhaust..... | 152 |
| Caster Wheels..... | 188 | fan belt..... | 153 |
| anti-shimmy..... | 191 | fuel..... | See Fuel System |
| ballast..... | 189 | inspection..... | 135 |
| bolt torque..... | 190 | manually turning..... | 136 |
| removal/installation..... | 190, 191 | monitoring..... | 35 |
| tread adjustment..... | 67 | oil level..... | 137 |
| CDM..... | 35 | oil pressure..... | 60 |
| CDM Displays..... | 36 | operating temperature..... | 60 |
| Charge Filter..... | 180 | operation..... | 57 |
| Circuit Breakers..... | 175 | servicing..... | 135 |
| Compressor Oil..... | 117 | speed adjustment..... | 155 |
| Console..... | 20 | starting..... | 57 |
| Cooler..... | 28 | throttle adjustment..... | 155 |

INDEX

| | | | |
|------------------------------------|----------------------------|--------------------------------|--------|
| troubleshooting..... | 196 | float switch | 34 |
| voltage..... | 60 | flotation..... | 80 |
| warm-up | 58 | functions..... | 35 |
| warning lights | 43, 60 | height control..... | 87 |
| Engine Cooling System..... | 147 | levelling | 83 |
| changing coolant..... | 148 | lift cylinder stops..... | 79 |
| coolant level & concentration..... | 147 | monitoring | 35 |
| cooling box servicing | 158 | on/off switch | 32 |
| radiator screen | 156 | operation | 79 |
| Engine Electrical System | | position switch..... | 34 |
| damage prevention..... | 165 | programming..... | 46 |
| Engine Forward..... | 64 | return to cut..... | 87 |
| Engine Hood | 121 | reverse | 84 |
| Engine Lock-out | | reverse switch | 32 |
| checks | 126 | stand | 92 |
| Error Codes | | troubleshooting..... | 200 |
| engine | 52, 211 | Header Control Switches | 33, 34 |
| windrower..... | 210 | Header Controls..... | 32 |
| Exhaust..... | 152 | Headlights | |
| Fan Belt | | alignment..... | 166 |
| replacement..... | 153 | Heater | |
| tension..... | 153 | controls..... | 27 |
| Fault Codes..... | 52, 210 | shut-off valve..... | 26 |
| Field Lights | | Height Control..... | 87 |
| bulb replace..... | 168 | Horn | 29 |
| Final Drive..... | 78 | Hub Locks | 78 |
| Float..... | 80 | Hydraulic System | 178 |
| deck shift | 101 | charge pump pressure | 183 |
| Float Adjustment | 80 | oil changing..... | 179 |
| Float Options..... | 82 | oil filter..... | 179 |
| Float Pin..... | 90, 93, 102, 105, 110, 113 | oil level | 178 |
| Flood Lights | | relief pressure | 181 |
| bulb replace..... | 169, 170 | traction drive..... | 183 |
| Fluids | 117 | transmission oil pressure..... | 183 |
| Fuel..... | 117 | troubleshooting..... | 199 |
| Fuel System | | valve block | 181 |
| filters..... | 143 | Hydraulics | |
| separator | 146 | fitting torque | 119 |
| supply valve..... | 145 | hoses and lines | 184 |
| Fuel System | | leaks..... | 184 |
| tank venting..... | 143 | Ignition Switch..... | 30 |
| Fuel System | | Interior Lights | 174 |
| priming | 146 | Jacking..... | 187 |
| Fuel Tank | | Knife Speed | |
| draining | 145 | auger header..... | 109 |
| Fueling | 59 | draper header..... | 100 |
| Fuses | 175 | Levelling the Header | 83 |
| Gauge Lights..... | 174 | Lift Cylinder Stops | 79 |
| Gauges | 30 | Lift Filter | 179 |
| Gearbox, Pump | | Lighting | |
| changing lubricant | 151 | cab forward | 23, 24 |
| lubricant level | 150 | engine forward | 24, 25 |
| Ground Speed | | road..... | 70 |
| control lever..... | 31 | Lights | 23 |
| range switch | 31 | Lubricants | 117 |
| Hazard Warning Lights..... | 31 | Lubrication | 124 |
| Header | | Maintenance Platforms | 122 |
| angle adjustment..... | 85 | Maintenance Record..... | 194 |
| attaching draper | 90 | Maintenance Schedule | 192 |
| detaching draper | 93 | Manual Storage..... | 28 |
| drive | 84 | Metric Conversion | 120 |
| drop rate..... | 88, 182 | Monitoring System | 36 |
| engage | 84 | Oil Cooler..... | 158 |
| float adjustment..... | 80 | Oil Filter..... | 138 |

INDEX

| | | | |
|---------------------------------------|---------|---------------------------|-----------------------|
| Operating Screens | 36 | fuel and lubricants | 117 |
| Operator's Console..... | 20 | windrower | 78 |
| Operator's Presence..... | 21 | Symbol Definitions..... | 53 |
| checks | 126 | Tail Lights | |
| engine..... | 21 | bulb replace | 171 |
| header drive..... | 21 | replace..... | 171 |
| transmission | 21 | Tire Inflation | |
| Operator's Station..... | 20 | caster wheels | 188 |
| troubleshooting | 204 | drive wheels | 185 |
| Options | 205 | Torques | 118 |
| Owner/Operator Responsibilities | 53 | Towing | |
| Park Brake..... | 130 | header | 71 |
| Pre-Season Check | 56 | tow-pole..... | 72 |
| Programming..... | 46 | Towing Windrower..... | 77 |
| Radiator Cap | 148 | Traction Drive System | |
| Radio..... | 29 | GSL adjustment..... | 127 |
| Rear View Mirrors..... | 26 | hub locks | 78 |
| Reel | | park brake | 130 |
| fore-aft | 95 | park brake switch..... | 130 |
| height switch..... | 95 | steering links | 128 |
| position switch | 33 | troubleshooting | 200, 201 |
| speed..... | 96, 108 | Training Seat..... | 22 |
| speed switch..... | 34 | Transporting..... | 69 |
| Refrigerant..... | 117 | Troubleshooting | |
| Relief Valve | 183 | air conditioning | 202 |
| settings | 52 | electrical | 199 |
| Return Filter..... | 180 | engine..... | 196 |
| Return to Cut..... | 87 | header drive | 200 |
| Rotors..... | 156 | hydraulics | 199 |
| Safety | | operator's Station | 204 |
| general..... | 12 | traction drive..... | 200 |
| operation..... | 55 | Turn Signals | 31 |
| procedures..... | 116 | Warnings | |
| signal words..... | 7 | engine..... | 43 |
| signs | 7 | WCM | 36 |
| symbols | 7 | Weight Box..... | 74 |
| Seat Adjustment | 21 | Welding | 116 |
| Seat Belts | 22 | Wheel Bolt Torque..... | 185, 190 |
| maintenance | 126 | Windrower | |
| Serial Number | 2 | components | 19 |
| Servicing | | dimensions | 17 |
| preparation | 116 | driving..... | 61 |
| Sight Glass | 179 | driving on road | 69 |
| Signal Lights..... | 171 | electrical | See Electrical System |
| Specifications | 15 | monitoring..... | 35 |
| Starting Engine..... | 57 | specifications | 15 |
| Steering Chain..... | 129 | towing | 77 |
| Steering Column Adjust..... | 22 | transporting | 69 |
| Steering Links..... | 128 | Windshield Wipers..... | 26 |
| Storage | | | |

CDM / WCM ENGINE ERROR CODES

CDM Error Codes for the M150 / 200 Tractor units

| | | | | | | | | | |
|-----------|---------------------|-------------------|--|--|--|--|--|--|---|
| E 1 | RANGE NOT ALLOWED | | | | | | | | HIGH range activated while in Cab forward (M150). |
| E 2 | RTC NOT ALLOWED | | | | | | | | Return To Cut activated with the header off. |
| E 3 | SIGNALS NOT ALLOWED | | | | | | | | Turn Signals activated while in Cab forward. |
| E 4 | HDR DRV NOT ALLOWED | | | | | | | | Header engage switch activated while in Engine forward. |
| E 5 | RTC NOT AVAILABLE | | | | | | | | Return To Cut activated while in Engine forward. |
| E 6 | TEMP GAUGE SHORT | | | | | | | | Wiring / connection problem. |
| E 7 | SPEED STICK SHORT | | | | | | | | Wiring / connection problem. |
| E 8 | HEADER ENABLE SHORT | | | | | | | | Wiring / connection problem. |
| E 9 | WCM ENABLE SHORT | | | | | | | | Wiring / connection problem. |
| E 10 | CDM INTERNAL ERROR | | | | | | | | Internal hardware or software problem. |
| E 11 | CDM POWER UP | | | | | | | | CDM Module did not power up correctly. |
| E 12 | WCM POWER UP | | | | | | | | WCM Module did not power up correctly. |
| E 13 | FUEL SOLENOID | | | | | | | | WCM Fuel solenoid output fault detected. |
| E 14 E114 | DWA DRIVE PWM | V 1 3 | | | | | | | DWA Drive - PWM solenoid drive fault detected - short circuit / open circuit |
| E 15 E115 | KNIFE DRIVE PWM | V 8 | | | | | | | Knife drive - PWM solenoid drive fault detected - short circuit / open circuit |
| E 16 E116 | DRAPER DRV PWM | V 9 A | | | | | | | Draper Drive - PWM solenoid drive fault detected - short circuit / open circuit |
| E 17 E117 | REEL DRIVE PWM | V 9 B | | | | | | | Reel Drive - PWM solenoid drive fault detected - short circuit / open circuit |
| E 18 | | | | | | | | | |
| E 19 E119 | LOAD SENSE | V 1 6 | | | | | | | Disc Block valve 16 - solenoid drive fault detected - short circuit / open circuit |
| E 20 | | | | | | | | | |
| E 21 E121 | REVERSER | V 1 1 C | | | | | | | Reverser - Solenoid V14 fault detected - short circuit / open circuit |
| E 22 | | | | | | | | | |
| E 23 E123 | REVERSER | V 1 1 A / B / 1 2 | | | | | | | Reverser - Solenoid V11A, 11B or 12 fault detected - short circuit / open circuit |
| E 24 E124 | DECK SHFT RIGHT | V 1 4 | | | | | | | Right Deck Shift solenoid V14 fault detected - short circuit / open circuit |
| E 25 E125 | DECK SHFT LEFT | V 1 5 | | | | | | | Left Deck Shift solenoid V15 fault detected - short circuit / open circuit |
| E 26 E126 | DWA UP | V 2 C 2 | | | | | | | DWA Raise solenoid V2C2 fault detected - short circuit / open circuit |
| E 27 E127 | DWA DOWN | V 4 C 2 | | | | | | | DWA Lower solenoid V4C2 fault detected - short circuit / open circuit |
| E 28 E128 | TILT RETRACT | V 2 B | | | | | | | Tilt Retract solenoid V2B fault detected - short circuit / open circuit |
| E 29 E129 | TILT EXTEND | V 2 A | | | | | | | Tilt Extend solenoid V2A fault detected - short circuit / open circuit |
| E 30 E130 | 4 WAY VALVE | V 6 | | | | | | | 4 Way valve solenoid V6 fault detected - short circuit / open circuit |
| E 31 E131 | BYPASS VALVE | V 1 | | | | | | | Bypass valve solenoid V1 fault detected - short circuit / open circuit |
| E 32 E132 | HEADER UP / DOWN | V 4 A | | | | | | | Header up / down solenoid V4A fault detected - short circuit / open circuit |
| E 33 E133 | SCREEN CLEANERS | | | | | | | | Screen cleaner output fault detected - short circuit / open circuit |
| E 34 E134 | RIGHT STOP LAMP | | | | | | | | Right stop lamp output fault detected - short circuit / open circuit |
| E 35 E135 | LEFT STOP LAMP | | | | | | | | Left stop lamp output fault detected - short circuit / open circuit |
| E 36 E136 | RIGHT TURN LAMP | | | | | | | | Right turn lamp output fault detected - short circuit / open circuit |
| E 37 E137 | LEFT TURN LAMP | | | | | | | | Left turn lamp output fault detected - short circuit / open circuit |
| E 38 E138 | MAIN DRIVE | V 1 0 | | | | | | | Main header drive solenoid V10 fault detected - short circuit / open circuit |
| E 39 E139 | MID RANGE | V 5 B | | | | | | | M200 Mid range solenoid V5B fault detected - short circuit / open circuit |
| E 40 E140 | HIGH RANGE | V 5 A | | | | | | | High range solenoid V5A fault detected - short circuit / open circuit |
| E 41 E141 | REEL AFT | V 2 C | | | | | | | Reel aft solenoid V2C fault detected - short circuit / open circuit |
| E 42 E142 | REEL FORE | V 4 C | | | | | | | Reel fore solenoid V4C fault detected - short circuit / open circuit |
| E 43 E143 | REEL UP / DOWN | V 4 B | | | | | | | Reel up / down solenoid V4B fault detected - short circuit / open circuit |
| E 44 E144 | FLOAT RHS | V 7 B | | | | | | | RHS float solenoid V7B fault detected - short circuit / open circuit |
| E 45 E145 | FLOAT LHS | V 7 A | | | | | | | LHS float solenoid V7A fault detected - short circuit / open circuit |
| E 46 | SENSOR VOLTS HIGH | | | | | | | | Sensor voltage output high. |
| E 47 | SENSOR VOLTS LOW | | | | | | | | Sensor voltage output low. |
| E 48 | WCM OVER TEMP | | | | | | | | WCM over temp fault. |
| E 49 | WCM LOW TEMP | | | | | | | | WCM low temp fault. |
| E 50 | BATT+ OUT OF RANGE | | | | | | | | System voltage above 16.5 VDC. |
| E 51 E151 | DISK DRIVE PWM | V 8 | | | | | | | Disk header drive solenoid V8 fault detected - short circuit / open circuit |

Error codes E52 to E63 not allocated

| | | | | | | | | | |
|------|---------------------|--|--|--|--|--|--|--|--|
| E 64 | HEADER OIL PRESSURE | | | | | | | | Header drive charge pressure low (228) |
| E 65 | KNIFE OVERLOAD | | | | | | | | Low knife speed detected < setpoint |
| E 66 | #.# LOW VOLTS | | | | | | | | Low system voltage <11.5 VDC |
| E 67 | TRANS OIL PRESSURE | | | | | | | | Drive supercharge pressure low (202) |
| E 68 | TRANS OIL TEMP | | | | | | | | Trans oil temp >221 deg F. |
| E 69 | ENGINE AIR FILTER | | | | | | | | Engine air filter plugged |
| E 70 | HYDRAULIC FILTER | | | | | | | | Hydraulic filter pressure too high. (227) |
| E 71 | LOW HYDRAULIC OIL | | | | | | | | Low hydraulic oil level sensor tripped (225) |
| E 72 | #.# HIGH VOLTS | | | | | | | | System voltage above |

Error codes E73 to E100 not allocated

| | | | | | | | | | |
|------|--------------------|--|--|--|--|--|--|--|------------------------------------|
| E101 | SPI ERROR | | | | | | | | J1939 Can error |
| E102 | CAN ERROR | | | | | | | | J1939 Can error |
| E103 | EEPROM READ ERROR | | | | | | | | Internal error |
| E104 | EEPROM WRITE ERROR | | | | | | | | Internal error |
| E105 | TEMP SENSOR ERROR | | | | | | | | Internal temperature sensor error. |

MISC INFORMATION / ERROR CODES

| | | | | | | | | | |
|-----------------------|--|--|--|--|--|--|--|--|--|
| ENGINE OIL PRESSURE | | | | | | | | | Engine oil pressure warning. |
| ENGINE TEMPERATURE | | | | | | | | | Engine coolant temperature warning. |
| CANBUSS ERROR | | | | | | | | | |
| KNIFE SPD OVERLOAD | | | | | | | | | Knife speed is < programmed setpoint while header engaged. |
| NO OPERATOR | | | | | | | | | Operator not detected in seat (~3 second delay before message) |
| NO HEADER | | | | | | | | | No header ID detected - not hooked up or wiring error. |
| LOCK SEAT BASE | | | | | | | | | Seat base not detected in either Cab or Engine forward position. |
| DISENGAGE HEADER | | | | | | | | | Header engage switch on when ignition turned on. |
| x x x x S x x F x x C | | | | | | | | | Engine code configuration (Canbus) |
| CENTER STEERING | | | | | | | | | GSL or Pintal switches not closed with the key on / engine off. |
| NOT IN PARK | | | | | | | | | GSL or Pintal switches not closed with the key on / engine off. |
| BRAKE ON | | | | | | | | | Engine running GSL out of "PARK" brake is still engaged. |
| PLACE GSL INTO " N " | | | | | | | | | GSL or Pintal switches not closed with the key on / engine off. |
| BRAKE SW FAILURE | | | | | | | | | Ignition on / engine not running - brake switch and relay closed |
| BRAKE OFF | | | | | | | | | Engine running - brake solenoid not activated. |
| CHECK SEAT SWITCHES | | | | | | | | | System detects that both seat switches are active. |
| CAB FORWARD SW ON | | | | | | | | | If both switches are detected to be activated then the display |
| ENG FORWARD SW ON | | | | | | | | | will alternately flash between these two messages. |

M205 ENGINE ERROR CODES

Example: CDM displays the Error Code **110S 16F 28C**

STEP 1. **110S** – **S** is **SPN** column, then locate code **110** in that column.

STEP 2. **16F** – **F** is the **FMI** column, then locate code **16** in that column.

STEP 3. **28C** – **C** is occurrences, **28** is the quantity.

STEP 4. **DESCRIPTION** - Coolant Temperature High - Data Valid but Above Normal Operational Range - Moderately Severe Level Engine Coolant Temp.

STEP 5. Refer to **LAMP COLOR** and specific **ENGINE CODES** as required.

| J1939 SPN Description | J1939 SPN | J1939 FMI | Lamp Color | Cummins Engine Code | Description |
|--|-----------|-----------|------------|---------------------|--|
| Crankcase Pressure | 22 | 3 | Amber | 719 | Extended Crankcase Blow-by Pressure Circuit - Voltage Above Normal, or Shorted to High Source |
| | | 4 | Amber | 729 | Extended Crankcase Blow-by Pressure Circuit - Voltage Below Normal, or Shorted to Low Source |
| Coolant Temperature | 32 | 3 | Amber | 2111 | Coolant Temperature 2 Sensor Circuit - Voltage Above Normal, or Shorted to High Source |
| | | 0 | Red | 2114 | Coolant Temperature 2 - Data Valid but Above Normal Operational Range - Most Severe Level |
| | 52 | 4 | Amber | 2112 | Coolant Temperature 2 Sensor Circuit - Voltage Below Normal, or Shorted to Low Source |
| | | 16 | Amber | 2113 | Coolant Temperature 2 - Data Valid but Above Normal Operational Range - Moderately Severe Level |
| Accelerator Pedal Position | 91 | 0 | Red | 148 | Accelerator Pedal or Lever Position Sensor Circuit – Abnormal Frequency, Pulse Width, or Period |
| | | 1 | Red | 147 | Accelerator Pedal or Lever Position Sensor Circuit – Abnormal Frequency, Pulse Width, or Period |
| | | 2 | Red | 1242 | Accelerator Pedal or Lever Position Sensor 1 and 2 - Data Erratic, Intermittent, or Incorrect |
| | | 3 | Red | 131 | Accelerator Pedal or Lever Position Sensor Circuit - Voltage Above Normal, or Shorted to High Source |
| | | 4 | Red | 132 | Accelerator Pedal or Lever Position Sensor Circuit - Voltage Below Normal, or Shorted to Low Source |
| | | 8 | 154 | | Abnormal frequency, pulse width, or period |
| | | 12 | 154 | | Bad Device or component |
| | | 19 | Red | 287 | SAE J1939 Multiplexing Accelerator Pedal or Lever Sensor System Error - Received Network Data In Error |
| Fuel Delivery Pressure | 94 | 1 | Amber | 2216 | Fuel Pump Delivery Pressure - Data Valid but Above Normal Operational Range – Moderately Severe Level |
| | | 2 | Amber | 268 | Fuel Pressure Sensor Circuit - Data Erratic, Intermittent, or Incorrect |
| | | 3 | Amber | 546 | Fuel Delivery Pressure Sensor Circuit - Voltage Above Normal or Shorted to High Source |
| | | 4 | Amber | 547 | Fuel Delivery Pressure Sensor Circuit - Voltage Below Normal or Shorted to Low Source |
| | | 15 | Maint | 2261 | Fuel Pump Delivery Pressure – Data Valid but Above Normal Operational Range - Least Severe Level |
| | | 17 | Maint | 2262 | Fuel Pump Delivery Pressure – Data Valid but Below Normal Operational Range - Least Severe Level |
| | | 18 | Amber | 2215 | Fuel Pump Delivery Pressure - Data Valid but Below Normal Operational Range - Moderately Severe Level |
| Engine Fuel Filter Differential Pressure | 95 | 16 | Amber | 2372 | Engine Fuel Filter Differential Pressure - Data Valid but Above Normal Operational Range - Moderately Severe level |
| Water in Fuel Indicator | 97 | 3 | Amber | 428 | Water in Fuel Sensor Circuit - Voltage Above Normal, or Shorted to High Source |
| | | 4 | Amber | 429 | Water in Fuel Sensor Circuit - Voltage Below Normal, or Shorted to Low Source |
| | | 15 | Maint | 418 | Water in Fuel Indicator High - Data Valid but Above Normal Operational Range – Least Severe Level |
| | | 16 | Amber | 1852 | Water in Fuel Indicator - Data Valid but Above Normal Operational Range - Moderately Severe Level |

M205 ENGINE ERROR CODES

| J1939 SPN Description | J1939 SPN | J1939 FMI | Lamp Color | Cummins Engine Code | Description |
|--------------------------------|-----------|-----------|------------|---------------------|--|
| | | | | | |
| Engine Oil Pressure | 100 | 1 | Red | 415 | Oil Pressure Low – Data Valid but Below Normal Operational Range - Most Severe Level |
| | | 2 | Amber | 435 | Oil Pressure Sensor Circuit - Data Erratic, Intermittent, or Incorrect |
| | | 3 | Amber | 135 | Oil Pressure Sensor Circuit - Voltage Above Normal, or Shorted to High Source |
| | | 4 | Amber | 141 | Oil Pressure Sensor Circuit - Voltage Below Normal, or Shorted to Low Source |
| | | 10 | 157 | | Engine oil pressure sensor 5V supply connection open circuit |
| | | 17 | N/A | | Low oil pressure - WARNING |
| | | 18 | Amber | 143 | Oil Pressure Low – Data Valid but Below Normal Operational Range - Moderately Severe Level |
| Boost Pressure | 102 | 2 | Amber | 433 | Intake Manifold Pressure Sensor Circuit - Data Erratic, Intermittent, or Incorrect |
| | | 3 | Amber | 122 | Intake Manifold Pressure Sensor Circuit – Voltage Above Normal, or Shorted to High Source |
| | | 4 | Amber | 123 | Intake Manifold Pressure Sensor Circuit – Voltage Below Normal, or Shorted to Low Source |
| | | 16 | Amber | 124 | Intake Manifold 1 Pressure Data Valid but Above Normal – Operational Range - Moderately Severe Level |
| Turbocharger 1 Speed | 103 | 10 | Amber | 2345 | Turbocharger speed invalid rate of change detected - Abnormal Rate of Change |
| | | 16 | Amber | 595 | Turbocharger #1 Speed High - Data Valid but Above Normal Operational Range – Moderately Severe Level |
| | | 18 | Amber | 687 | Turbocharger #1 Speed Low - Data Valid but Below Normal Operational Range – Moderately Severe Level |
| Intake Manifold #1 Temp | 105 | 0 | Red | 155 | Intake Manifold Air Temperature High – Data Valid but Above Normal Operational Range - Most Severe Level |
| | | 3 | Amber | 153 | Intake Manifold Air Temperature Sensor Circuit - Voltage Above Normal, or Shorted to High Source |
| | | 4 | Amber | 154 | Intake Manifold Air Temperature Sensor Circuit - Voltage Below Normal, or Shorted to Low Source |
| | | 15 | None | 2964 | Intake Manifold Temperature High - Data Valid but Above Normal Operational Range - Least Severe Level |
| | | 16 | Amber | 488 | Intake Manifold 1 Temperature - Data Valid but Above Normal Operational Range - Moderately Severe Level |
| Inlet Manifold Pressure Sensor | 106 | 3 | 135 | | Voltage above normal or shorted high |
| | | 4 | 135 | | Voltage below normal or shorted low |
| | | 10 | 135 | | Inlet Manifold Pressure Sensor 5V supply connection open circuit |
| Barometric Pressure | 108 | 2 | Amber | 295 | Barometric Pressure Sensor Circuit - Data Erratic, Intermittent, or Incorrect |
| | | 3 | Amber | 221 | Barometric Pressure Sensor Circuit – Voltage Above Normal, or Shorted to High Source |
| | | 4 | Amber | 222 | Barometric Pressure Sensor Circuit – Voltage Below Normal, or Shorted to Low Source |
| Coolant Pressure | 109 | 3 | Amber | 231 | Coolant Pressure Sensor Circuit - Voltage Above Normal, or Shorted to High Source |
| | | 4 | Amber | 232 | Coolant Pressure Sensor Circuit - Voltage Below Normal, or Shorted to Low Source |
| | | 18 | Amber | 233 | Coolant Pressure - Data Valid but Below Normal Operational Range - Moderately Severe Level |
| Engine Coolant Temperature | 110 | 0 | Red | 151 | Coolant Temperature Low - Data Valid but Above Normal Operational Range - Most Severe Level |
| | | 2 | Amber | 334 | Coolant Temperature Sensor Circuit – Data Erratic, Intermittent, or Incorrect |
| | | 3 | Amber | 144 | Coolant Temperature Sensor Circuit – Voltage Above Normal, or Shorted to High Source |
| | | 4 | Amber | 145 | Coolant Temperature Sensor Circuit – Voltage Below Normal, or Shorted to Low Source |
| | | 15 | None | 2963 | Engine Coolant Temperature High - Data Valid but Above Normal Operational Range - Least Severe Level |
| | | 16 | Amber | 146 | Coolant Temperature High - Data Valid but Above Normal Operational Range - Moderately Severe Level |

M205 ENGINE ERROR CODES

| J1939 SPN Description | J1939 SPN | J1939 FMI | Lamp Color | Cummins Engine Code | Description |
|---------------------------------------|-----------|-----------|------------|---------------------|---|
| Injector Metering Rail 1 Pressure | 157 | 0 | Red | 449 | Fuel Pressure High - Data Valid but Above Normal Operational Range – Moderately Severe Level |
| | | 1 | Amber | 2249 | Injector Metering Rail 1 Pressure - Data Valid but Below Normal Operational Range - Most Severe Level |
| | | 2 | Amber | 554 | Fuel Pressure Sensor Error - Data Erratic, Intermittent, or Incorrect |
| | | 3 | Amber | 451 | Injector Metering Rail #1 Pressure Sensor Circuit - Voltage Above Normal, or Shorted to High Source |
| | | 4 | Amber | 452 | Injector Metering Rail #1 Pressure Sensor Circuit - Voltage Below Normal, or Shorted to Low Source |
| | | 16 | Amber | 553 | Injector Metering Rail #1 Pressure High – Data Valid but Above Normal Operational Range - Moderately Severe Level |
| | | 18 | Amber | 559 | Injector Metering Rail #1 Pressure Low – Data Valid but Below Normal Operational Range - Moderately Severe Level |
| Key Switch | 158 | 2 | 439 | | Data erratic, intermittent, or incorrect |
| Cylinder Power | 166 | 2 | None | 951 | Cylinder Power Imbalance Between Cylinders - Data Erratic, Intermittent, or Incorrect |
| Alternator Potential (voltage) | 167 | 1 | Red | 598 | Electrical Charging System Voltage Low – Data Valid but Below Normal Operational Range - Most Severe Level |
| | | 16 | Amber | 596 | Electrical Charging System Voltage High – Data Valid but Above Normal Operational Range - Moderately Severe Level |
| | | 18 | Amber | 597 | Electrical Charging System Voltage Low – Data Valid but Below Normal Operational Range - Moderately Severe Level |
| ECM battery power | 168 | 0 | | | Excessive battery power |
| | | 1 | 422 | | Low battery power |
| | | 2 | | | Intermittent |
| | | 16 | Amber | 442 | Battery #1 Voltage High - Data Valid but Above Normal Operational Range – Moderately Severe Level |
| | | 18 | Amber | 441 | Battery #1 Voltage Low - Data Valid but Below Normal Operational Range – Moderately Severe Level |
| Ambient Air Temperature | 171 | 3 | Amber | 249 | Ambient Air Temperature Sensor Circuit - Voltage Above Normal, or Shorted to High Source |
| | | 4 | Amber | 256 | Ambient Air Temperature Sensor Circuit - Voltage Below Normal, or Shorted to Low Source |
| Fuel Temperature | 174 | 3 | Amber | 263 | Engine Fuel Temperature Sensor 1 Circuit - Voltage Above Normal, or Shorted to High Source |
| | | 4 | Amber | 265 | Engine Fuel Temperature Sensor 1 Circuit - Voltage Below Normal, or Shorted to Low Source |
| | | 16 | Amber | 261 | Engine Fuel Temperature - Data Valid but Above Normal Operational Range - Moderately Severe Level |
| Oil Temperature | 175 | 0 | Red | 214 | Engine Oil Temperature - Data Valid but Above Normal Operational Range - Most Severe Level |
| | | 2 | Amber | 425 | Engine Oil Temperature -Data Erratic, Intermittent, or Incorrect |
| | | 3 | Amber | 212 | Engine Oil Temperature Sensor 1 Circuit - Voltage Above Normal, or Shorted to High Source |
| | | 4 | Amber | 213 | Engine Oil Temperature Sensor 1 Circuit - Voltage Below Normal, or Shorted to Low Source |
| Engine Speed | 190 | 0 | Red | 234 | Engine Speed High - Data Valid but Above Normal Operational Range - Most Severe Level |
| | | 2 | Amber | 689 | Primary Engine Speed Sensor Error – Data Erratic, Intermittent, or Incorrect |
| | | 8 | 141 | | Abnormal signal frequency |
| | | 15 | N/A | | Engine Overspeed - WARNING |
| Real Time Clock Power | 251 | 2 | Maint | 319 | Real Time Clock Power Interrupt - Data Erratic, Intermittent, or Incorrect |
| Exhaust Gas Recirculation Temperature | 412 | 3 | Amber | 2375 | Exhaust Gas Recirculation Temperature Sensor Circuit - Voltage Above Normal, or Shorted to High Source |
| | | 4 | Amber | 2376 | Exhaust Gas Recirculation Temperature Sensor Circuit - Voltage Below Normal, or Shorted to Low Source |
| OEM Temperature #1 | 441 | 3 | Amber | 293 | Auxiliary Temperature Sensor Input # 1 Circuit -Voltage Above Normal, or Shorted to High Source |
| | | 4 | Amber | 294 | Auxiliary Temperature Sensor Input # 1 Circuit -Voltage Below Normal, or Shorted to Low Source |

M205 ENGINE ERROR CODES

| J1939 SPN Description | J1939 SPN | J1939 FMI | Lamp Color | Cummins Engine Code | Description |
|-----------------------------------|-----------|-----------|------------|---------------------|--|
| | | | | | |
| | | 14 | Red | 292 | Auxiliary Temperature Sensor Input # 1 Circuit - Special Instructions |
| Accelerator Pedal Low Idle Switch | 558 | 2 | Amber | 431 | Accelerator Pedal or Lever Idle Validation Circuit - Data Erratic, Intermittent, or Incorrect |
| | | 2 | 155 | | Data erratic, intermittent, or incorrect |
| | | 4 | Amber | 551 | Accelerator Pedal or Lever Idle Validation Circuit - Voltage Below Normal, or Shorted to Low Source |
| | | 13 | Red | 432 | Accelerator Pedal or Lever Idle Validation Circuit - Out of Calibration |
| System Diagnostic code # 1 | | 3 | Amber | 2185 | Sensor Supply Voltage #4 Circuit – Voltage Above Normal, or Shorted to High Source |
| | | 4 | Amber | 238 | Sensor Supply Voltage #3 Circuit – Voltage Below Normal, or Shorted to Low Source |
| Fuel Inlet Meter Device | 611 | 16 | Amber | 2292 | Fuel Inlet Meter Device - Data Valid but Above Normal Operational Range - Moderately Severe Level |
| | | 18 | Amber | 2293 | Fuel Inlet Meter Device flow demand lower than expected - Data Valid but Below Normal Operational Range - Moderately Severe Level |
| Electronic Control Module | | 31 | Amber | 757 | Electronic Control Module data lost - Condition Exists |
| System Diagnostic Code # 2 | 612 | 2 | Red | 115 | Engine Speed / Position Sensor Circuit lost both of two signals from the magnetic pickup sensor - Data Erratic, Intermittent, or incorrect |
| Red Stop Lamp | 623 | 4 | Amber | 244 | Red Stop lamp Driver Circuit - Voltage Below Normal, or Shorted to Low Source |
| Power Supply | 627 | 2 | Amber | 434 | Power Lost without Ignition Off - Data Erratic, Intermittent, or Incorrect |
| Controller #1 | 629 | 12 | Red | 111 | Engine Control Module Critical internal failure - Bad intelligent Device or Component |
| Calibration Memory | 630 | 2 | Amber | 341 | Engine Control Module data lost - Data Erratic, Intermittent, or Incorrect |
| | | 13 | Red | 342 | Electronic Calibration Code Incompatibility - Out of Calibration |
| | | 31 | Amber | 2217 | ECM Program Memory (RAM) Corruption - Condition Exists |
| Engine software | 631 | 2 | 415 | | Data incorrect |
| Fuel Control Valve #1 | 633 | 31 | Amber | 2311 | Fueling Actuator #1 Circuit Error – Condition Exists |
| Primary to secondary speed signal | 637 | 11 | 143 | | Calibration fault |
| SAE J1939 Datalink | 639 | 9 | Amber | 285 | SAE J1939 Multiplexing PGN Timeout Error - Abnormal Update Rate |
| | | 13 | Amber | 286 | SAE J1939 Multiplexing Configuration Error – Out of Calibration |
| Variable Geometry Turbocharger | 641 | 3 | Amber | 2385 | VGT Actuator Driver Circuit - Voltage Above Normal, or Shorted to High Source |
| | | 4 | Amber | 2384 | VGT Actuator Driver Circuit - Voltage Below Normal, or Shorted to Low Source |
| Turbo Wastegate | 646 | 5 | 177 | | Solenoid Current Low |
| | | 6 | 177 | | Solenoid Current High |
| Injector Cylinder #01 | 651 | 5 | Amber | 322 | Injector Solenoid Cylinder #1 Circuit – Current Below Normal, or Open Circuit |
| | | 6 | N/A | | Injector Current High |
| | | 7 | Amber | 1139 | Injector Cylinder #1 - Mechanical System Not Responding Properly or Out of Adjustment |
| Injector Cylinder #02 | 652 | 5 | Amber | 331 | Injector Solenoid Cylinder #2 Circuit – Current Below Normal, or Open Circuit |
| | | 6 | N/A | | Injector Current High |
| | | 7 | Amber | 1141 | Injector Cylinder #2 - Mechanical System Not Responding Properly or Out of Adjustment |
| Injector Cylinder #03 | 653 | 5 | Amber | 324 | Injector Solenoid Cylinder #3 Circuit – Current Below Normal, or Open Circuit |

M205 ENGINE ERROR CODES

| J1939 SPN Description | J1939 SPN | J1939 FMI | Lamp Color | Cummins Engine Code | Description |
|---|-----------|-----------|------------|---------------------|---|
| | | 6 | N/A | | Injector Current High |
| | | 7 | Amber | 1142 | Injector Cylinder #3 - Mechanical System Not Responding Properly or Out of Adjustment |
| Injector Cylinder #04 | 654 | 5 | Amber | 332 | Injector Solenoid Cylinder #4 Circuit – Current Below Normal, or Open Circuit |
| | | 6 | N/A | | Injector Current High |
| | | 7 | Amber | 1143 | Injector Cylinder #4 - Mechanical System Not Responding Properly or Out of Adjustment |
| Injector Cylinder #05 | 655 | 5 | Amber | 323 | Injector Solenoid Cylinder #5 Circuit – Current Below Normal, or Open Circuit |
| | | 6 | N/A | | Injector Current High |
| | | 7 | Amber | 1144 | Injector Cylinder #5 - Mechanical System Not Responding Properly or Out of Adjustment |
| Injector Cylinder #06 | 656 | 5 | Amber | 325 | Injector Solenoid Cylinder #6 Circuit – Current Below Normal, or Open Circuit |
| | | 6 | N/A | | Injector Current High |
| | | 7 | Amber | 1145 | Injector Cylinder #6 - Mechanical System Not Responding Properly or Out of Adjustment |
| Glow Plug Start Aid relay | 676 | 5 | 199 | | Current Low |
| | | 6 | 199 | | Current High |
| Starter Solenoid Lockout Relay Driver Circuit | 677 | 3 | Amber | 584 | Starter Relay Circuit - Voltage Above Normal, or Shorted to High Source |
| | | 4 | Amber | 585 | Starter Relay Circuit - Voltage Below Normal, or Shorted to Low Source |
| 8V DC supply | 678 | 3 | 517 | | ECM 8V DC supply – voltage above normal or shorted high |
| | | 4 | 517 | | ECM 8V DC supply – voltage below normal or shorted low |
| Engine Speed Sensor #2 | 723 | 2 | Amber | 753 | Engine Speed/Position #2 Camshaft sync error -Data Erratic, Intermittent, or Incorrect |
| | | 7 | Amber | 731 | Engine Speed/Position #2 mechanical misalignment between camshaft and crankshaft sensors - Mechanical System Not Responding Properly or Out of Adjustment |
| | | 8 | 142 | | Abnormal signal frequency |
| Intake Air Heater #1 | 729 | 3 | Amber | 2555 | Intake Air Heater #1 Circuit - Voltage Above Normal, or Shorted to High Source |
| | | 4 | Amber | 2556 | Intake Air Heater #1 Circuit - Voltage Below Normal, or Shorted to Low Source |
| Internal Sensor Voltage Supply | 1043 | 3 | Amber | 387 | Accelerator Pedal or Lever Position Sensor Supply Voltage Circuit - Voltage Above Normal, or Shorted to High Source |
| | | 4 | Amber | 284 | Engine Speed/Position Sensor (Crankshaft) Supply Voltage Circuit - Voltage Below Normal, or Shorted to Low Source |
| Electric Lift Pump for Engine Fuel | 1075 | 3 | Amber | 2265 | Fuel Priming Pump Control Signal Circuit – Voltage Above Normal, or Shorted to High Source |
| | | 4 | Amber | 2266 | Fuel Priming Pump Control Signal Circuit – Voltage Below Normal, or Shorted to Low Source |
| 5 Volts DC Supply | 1079 | 3 | Amber | 386 | Sensor Supply Voltage #1 Circuit – Voltage Above Normal, or Shorted to High Source |
| | | 4 | Amber | 352 | Sensor Supply Voltage #1 Circuit – Voltage Below Normal, or Shorted to Low Source |
| 5 Volts DC Supply | 1080 | 3 | Amber | 227 | Sensor Supply Voltage #2 Circuit – Voltage Above Normal, or Shorted to High Source |
| | | 4 | Amber | 187 | Sensor Supply Voltage #2 Circuit – Voltage Below Normal, or Shorted to Low Source |
| Sensor Circuit - Voltage | 1136 | 3 | Amber | 697 | ECM Internal Temperature Sensor Circuit - Voltage Above Normal, or Shorted to High Source |
| | | 4 | Amber | 698 | ECM Internal Temperature Sensor Circuit - Voltage Below Normal, or Shorted to Low Source |
| Turbocharger #1 Compressor Inlet Temperature | 1172 | 3 | Amber | 691 | Turbocharger #1 Compressor Inlet Temperature Sensor Circuit – Voltage Above Normal, or Shorted to High Source |
| | | 4 | Amber | 692 | Turbocharger #1 Compressor Inlet Temperature Sensor Circuit – Voltage Below Normal, or Shorted to Low Source |
| Turbo Wastegate | 1188 | 7 | 177 | | Turbo Wastegate not responding |

M205 ENGINE ERROR CODES

| J1939 SPN Description | J1939 SPN | J1939 FMI | Lamp Color | Cummins Engine Code | Description |
|---|-----------|-----------|------------|---------------------|--|
| Exhaust Gas Pressure | 1209 | 3 | Amber | 2373 | Exhaust Gas Pressure Sensor Circuit - Voltage Above Normal, or Shorted to High Source |
| | | 4 | Amber | 2374 | Exhaust Gas Pressure Sensor Circuit - Voltage Below Normal, or Shorted to Low Source |
| Fuel Pump Pressurizing Assembly #1 | 1347 | 3 | Amber | 272 | High Fuel Pressure Solenoid Valve Circuit – Voltage Above Normal, or Shorted to High Source |
| | | 4 | Amber | 271 | High Fuel Pressure Solenoid Valve Circuit – Voltage Below Normal, or Shorted to Low Source |
| | | 5 | 162 | | Output current low |
| | | 6 | 162 | | Output current high |
| | | 7 | Amber | 281 | High Fuel Pressure Solenoid Valve #1 – Mechanical System Not Responding Properly or Out of Adjustment |
| Engine Oil Change Interval | 1378 | 31 | Maint | 649 | Change Lubricating Oil and Filter – Condition Exists |
| Auxiliary Pressure | 1388 | 3 | Amber | 297 | Auxiliary Pressure Sensor Input # 2 Circuit - Voltage Above Normal, or Shorted to High Source |
| | | 4 | Amber | 298 | Auxiliary Pressure Sensor Input # 2 Circuit - Voltage Below Normal, or Shorted to Low Source |
| | | 14 | Red | 296 | Auxiliary Pressure Sensor Input 1 - Special Instructions |
| J1939 Error | 1484 | 31 | None | 211 | Additional Auxiliary Diagnostic Codes logged - Condition Exists |
| Control Module Identification Input State | 1563 | 2 | Amber | 1256 | Control Module Identification Input State Error - Data Erratic, Intermittent, or Incorrect |
| Accelerator Pedal Position | 2623 | 3 | Amber | 1239 | Accelerator Pedal or Lever Position Sensor 2 Circuit - Voltage Above Normal, or Shorted to High Source |
| | | 4 | Amber | 1241 | Accelerator Pedal or Lever Position Sensor 2 Circuit - Voltage Below Normal, or Shorted to Low Source |
| System Diagnostic Code #1 | 2629 | 15 | None | 2347 | Turbocharger Compressor Outlet Temperature (Calculated) - Data Valid but Above Normal Operational Range – Least Severe Level |
| System Diagnostic Code #1 | 2789 | 15 | None | 2346 | Turbocharger Turbine Inlet Temperature (Calculated) - Data Valid but Above Normal Operational Range – Least Severe Level |
| Coolant Pressure | 2981 | 3 | Amber | 2115 | Coolant Pressure 2 Circuit - Voltage Above Normal, or Shorted to High Source |
| | | 4 | Amber | 2116 | Coolant Pressure 2 Circuit -Voltage Below Normal, or Shorted to Low Source |
| | | 18 | Amber | 2117 | Coolant Pressure 2 - Data Valid but Below Normal Operational Range - Moderately Severe Level |
| System Diagnostic Code # 1 | 3511 | 4 | Amber | 238 | Sensor Supply Voltage #3 Circuit – Voltage Below Normal, or Shorted to Low Source |
| | | 3 | Amber | 239 | Sensor Supply Voltage #3 Circuit – Voltage Above Normal, or Shorted to High Source |