

# WINDROWING SOLUTIONS



**MacDon**

*The Harvesting Specialists.*

# HARVESTING PERFORMANCE

For over 75 years MacDon has been a world leader in technology, innovation, and manufacturing of high-performance harvesting equipment. Our harvesting history is rooted deep in the rich prairie heritage of Winnipeg, Manitoba, Canada. MacDon products are distributed and supported worldwide from offices in Canada, the United States, Australia, Brazil, and Germany.

MacDon's relentless pursuit of improvement is driven by the desire to make harvesting easier and more productive for farmers. Working directly with producers and custom harvesters in the toughest real-world conditions guides MacDon to pioneer industry-leading innovations like the FlexDraper®. MacDon has a worldwide reputation for excellence as *The Harvesting Specialists* and we are proud to make equipment that help producers harvest the crops that feed the world.

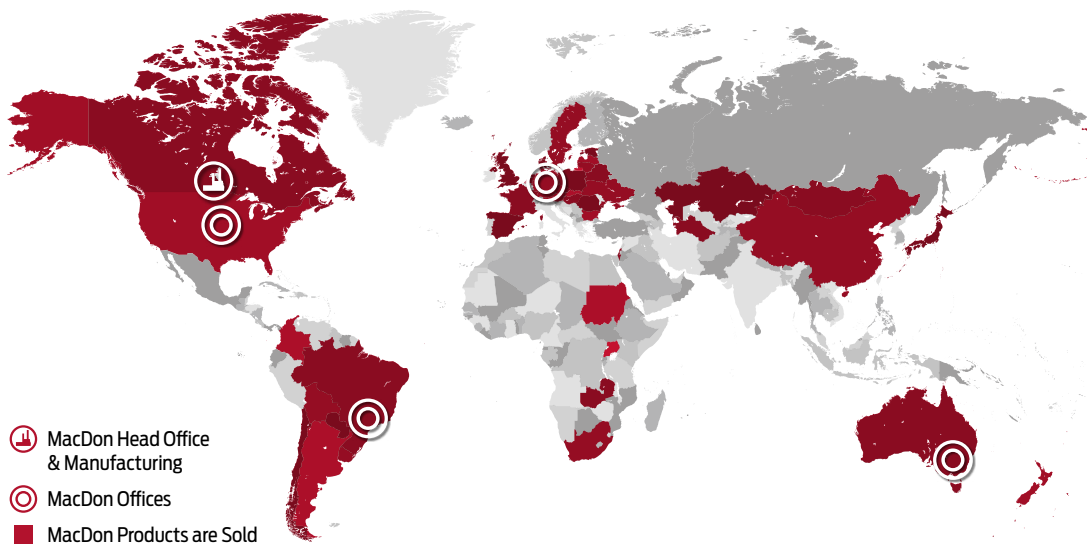

MacDon Industries Ltd.  
680 Moray Street  
Winnipeg, Manitoba, Canada R3J 3S3  
t. (204) 885 5590 f. (204) 832 7749



Scan here for all  
MacDon Global Offices



Connect with us on Social Media!





*\* Products and options may not be available in all regions. Contact your dealer for more information.*



# KEEP YOUR HARVESTING OPTIONS OPEN

As a farmer you deal with risk every day, so a little bit of control goes a long way. MacDon M2 Series Windrowers help widen your harvest window and give you more options to help manage that risk. MacDon has been perfecting the windrower concept for 75 years, so we know that with swathing comes great harvesting benefits: quicker harvest times, fully organic harvesting, a shorter season, an alternative to natural drying or desiccation, and even crop ripening. Here's how MacDon Windrowers can help you reach the next level of harvesting performance.



*\*Products and options may not be available in all regions. Contact your dealer for more information.*

## **EVEN CROP RIPENING**

When crop matures unevenly due to hilly terrain, climate, staggered seeding, or uneven germination, crop cut by the windrower will continue to ripen in the swath, evening out as it dries down to the correct moisture content. This helps improve grain quality and can even eliminate the requirement to dry grain after harvest. Swathing at the right time also reduces the amount of seed loss compared to leaving the crop standing until the lower seeds ripen.

## **ELIMINATING PRE-HARVEST CHEMICAL APPLICATIONS**

By swathing crops to trigger the dry-down process, pre-harvest chemical applications are eliminated. With farmers facing increased consumer and regulatory pressure, particularly around the pre-harvest use of glyphosate, swathing provides a viable option to manage harvest timing without chemical use.

## **WEED CONTROL**

Weeds can often reach maturity and produce seeds at the same time that the crop is going into the final stages of maturity. Windrowing a crop before final maturity can cut weeds before they have a chance to produce seeds, helping reduce weed pressure for the subsequent season. Also, swathed weeds will dry out, reducing the amount of green weed material going through the combine. In pulse crops such as edible beans, weeds may smear or stain the seeds. By swathing them prior to picking them up with the combine you give the weeds a chance to dry out.



### **MAXIMIZE COMBINE HARVESTER**

When picking up a swath with a MacDon PW8 Pick-Up Header, the combine operator can focus on the combine, rather than straight cutting. Using a PW8 eliminates double cutting residual standing straw that most times is still green and wet, and can affect combining efficiency. Combine stoppage from minor issues like broken knife sections is eliminated. Picking up a swath also helps reduce combine rock ingestion compared to direct cutting on the ground.

### **REDUCED CROP LOSS CAUSED BY WEATHER**

In the final stages of crop maturity, damage from wind or hail can cause crop losses that are higher in the unsheltered, standing crop. By protecting the majority of the crop in a swath for the final days until maturity, losses can be minimized.

### **MANAGING HARVEST TIMING**

Swathing can begin earlier than direct cutting, helping to spread out the harvest. The cutting of the crop is an instant action, resulting in a faster dry down compared to waiting for a pre-harvest glyphosate application to take effect.

### **MINIMIZE PEST DAMAGE**

For areas with pest issues, one of the best options for a successful harvest is to swath the crop before the pests damage the crop too much. This is done to control the infestation and damage the pests can do to the crops. By swathing before the crop suffers damage you can reduce your losses.

### **IN CASE OF INEFFECTIVE DESICCATION**

Wet, cold, cloudy weather and poor canopy penetration of the chemical may cause desiccation to be ineffective. Desiccation works best in hot and dry weather.

### **MULTI USE APPLICATION**

MacDon windrowers can be used in a variety of harvesting applications thanks to three cutting platforms; auger, rotary, and rigid drapers. MacDon D2 Series Draper Headers are interchangeable between windrower and combine applications.

### **DOUBLE WINDROWING ABILITY**

For low yield crop varieties, or in a low yielding year, the windrower can shift the drapers and place two swaths side by side. This effectively doubles the amount of crop going into the combine to keep the combine running at peak efficiency.

# M2 SERIES

## Narrow Transport Windrowers

### Performance in the Field and on the Road.

Engineered specifically for European roads, the MacDon M2170 NT (Narrow Transport) seamlessly combines full-sized harvesting capabilities with a road-friendly design. Its Stage V Cummins turbo diesel engine meets global emission standards while delivering enhanced power, improved efficiency, and simplified maintenance. The M2's HarvestTouch™ Display provides simple control with an intuitive touchscreen interface to keep you productive all day. Plus, all the usual goodies that make MacDon Windrowers a cut above, like Dual Direction Steering, 360 Degree Night Vision, CrossFlex™ Suspension, and more. **Get more all harvest long with MacDon M2 Windrowers.**

*\*Products and options may not be available in all regions. Contact your dealer for more information.*

*(Some of the images used may be of a different model with the same/similar feature.)*

M2 SERIES NT  
WEBSITE





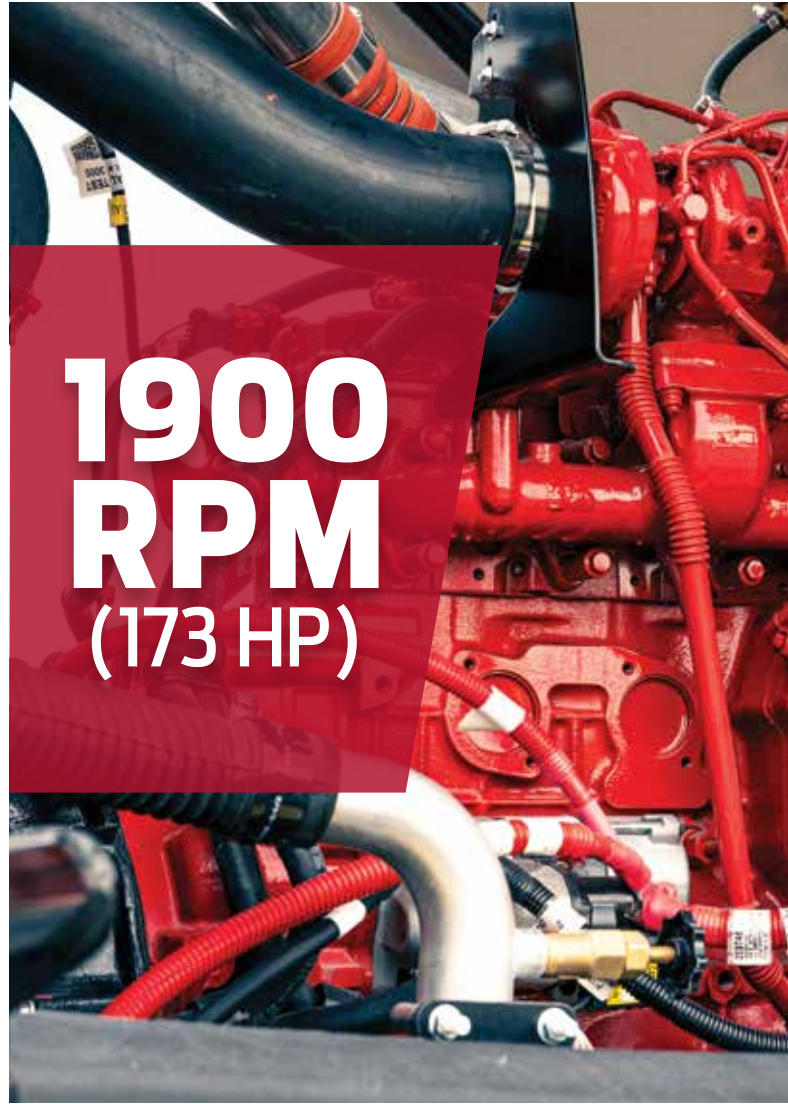





B

### A READY FOR EUROPEAN ROADS

Along with MacDon's patented Dual Direction® steering, you'll be able to navigate tight roadways with a narrow driving width of only 347 cm (137"), and safely cruise along at speeds of up to 45 km/h (28 mph)\*. Turn yourself around and set the machine to field mode, which pushes the machine's max-width to 440 cm (173"). In just minutes, you're ready to take advantage of massive crop clearance ability.

Featuring the Industry's best crop clearance with 115 cm (45") of height and 341 cm (134") of width, big bushy swaths flow effortlessly under M2 Series Windrowers.\* Ample header lift height lets you get up and over the tallest bushiest windrows with ease.

### B POWERFUL PERFORMANCE

The M2170 NT has a 4.5 liter 4 cylinder Stage V Cummins turbo diesel engine with a peak of 173 horsepower (129kW) at 1900 rpm. This engine meets global emission levels while delivering more power, improved efficiency, and easier maintenance. Clean, simple, efficient, and powerful, that's how you get more with MacDon M2 Series Windrowers.

C

### LOW MAINTENANCE RELATIONSHIP

Continuing MacDon's tradition of innovative solutions to make harvesting easy, the M2's design means you'll spend less time setting up and more time cutting.

- DEF and fuel fill at ground level
- 518 liter (137 gallon) fuel tank keeps you cutting all day
- Check the engine oil without lifting the hood
- Hydraulic oil level sight glass
- Easy access to the radiator and cooler box
- Sliding platform allows easy access
- Multi-coupler hydraulic hook-ups
- Easy-access lockable toolbox conveniently tucked away in the M2's platform

### C MASSIVE CROP CLEARANCE

Featuring the Industry's best crop clearance with 115 cm (45") of height and 341 cm (134") of width, big bushy swaths flow effortlessly under M2 Series Windrowers.\* Ample header lift height lets you get up and over the tallest bushiest windrows with ease.

*\*Measurements may vary depending on tires and tire setup.*



UP TO  
**45**  
KM/H  
(28 MPH)  
**ON ROAD**

## ON ROAD



Front



Back

## DUAL DIRECTION®

### FASTER IN & BETWEEN FIELDS

MacDon's patented CrossFlex™ Suspension makes in-field speeds up to 29 km/h (18 mph) possible, but MacDon's innovation doesn't stop there. With our patented Dual Direction® steering, you can switch from field to road mode in seconds and travel at speeds up to 45 km/h (28 mph)\*.

Hooking up and transporting MacDon drapers is quick and easy with MacDon's Easy Move Transport System and allows towing speeds up to 32 km/h (20 mph)\*. Spending more time in the field instead of transport is just another way you get more with MacDon.

*\*Always follow local traffic laws and regulations.*



UP TO  
**29**  
KM/H  
(18 MPH)  
**IN-FIELD**

# IN-FIELD

440 cm (173")



383 cm (151")



Front



Back







B

### A COOL OPERATOR

M2 Series Windrowers feature a dual radiator design. The cooling fan behind the cab pulls in clean air and kicks in to reverse independently to blow out debris from the radiator. This constant, fresh airflow keeps the engine and hydraulics running cool all day.

### B SMOOTHER RIDE & CLEANER CUTS

MacDon's patented CrossFlex™ Suspension makes in-field speeds up to 29 km/h (18 mph) possible, as this innovative design absorbs impact from rough terrain, allowing smooth harvesting no matter the field condition.

MacDon's Smooth innovations don't stop there. The Ultra Glide® cab has a four-corner independent gas shock suspension system featuring stabilization to prevent cab roll.

CrossFlex™ Suspension, Ultra Glide® cab, and an air ride seat in combination mean you'll enjoy a smooth, comfortable, and controlled harvesting experience with the M2, reducing fatigue to keep you cutting all day long.



E

### C 360 DEGREE NIGHT VISION

M2 Windrowers equipped with the deluxe cab option get you more with MacDon's 360 Degree Night Vision. Eight high-power LED work lights create a bright halo of light that lets you work safely long after the sun goes down.

### D MORE COMFORT EQUALS MORE PRODUCTIVITY

M2 Series Windrow's deluxe cab option takes comfort and performance to the next level, featuring heated and vented leather seating, power mirrors, and 360 Degree Night Vision from 8 high-power LED work lights. The bright halo of light from our Night Vision lets you transition smoothly from day to night.

### E INTUITIVE CONTROL

M2 Windrowers provide precision control at your fingertips with the all-new HarvestTouch™ Display. HarvestTouch™ precisely tracks your harvesting performance and provides user-customization features through an intuitive touchscreen interface.

The M2's precision controls feature a two-stage control allowing faster and more precise header positioning. In addition, users can easily program up to three One-Touch-Return buttons for immediate control of the header's height, tilt, knife speed, reel, or draper operations.

Trimble-ready integration means your M2 Windrower connects seamlessly to Trimble's guidance system.

**Harvest  
Touch™**  
DISPLAY

# D2 SERIES

## Windrower Draper Headers

### More Capacity, Durability, and Speed.

MacDon D2 Series Windrower Draper Headers feature super-sized capacity thanks to the ultra-deep 50-inch (127cm) deep draper deck. MacDon's all-new super-structured five-sided back tube frame design supports this tremendous capacity. And at the front, loading those massive drapers up is MacDon's ClearCut™ High-Speed Cutting System. **Capacity, durability, and speed; that's how MacDon D2 Series Headers get you more.**

*(Some of the images used may be of a different model with the same/similar feature.)*



D2 SERIES  
WEBSITE







### **CLEARCUT™ HIGH-SPEED CUTTING SYSTEM**

MacDon's ClearCut™ High-Speed Cutting System delivers clean cutting at up to 30% faster speeds\*. D2 Series Drapers deliver a smooth close shave with the help of our ClearCut™ PlugFree™ short guards. This guard design gets the knife as close to the ground as possible while protecting the blade from damaging debris in the field. In addition, ClearCut™ PlugFree Short Knife Guards resist plugging even in the nastiest conditions while providing the cleanest and closest shave of the ground.

*\*Compared to the previous model.*

**30%  
MORE  
SPEED**



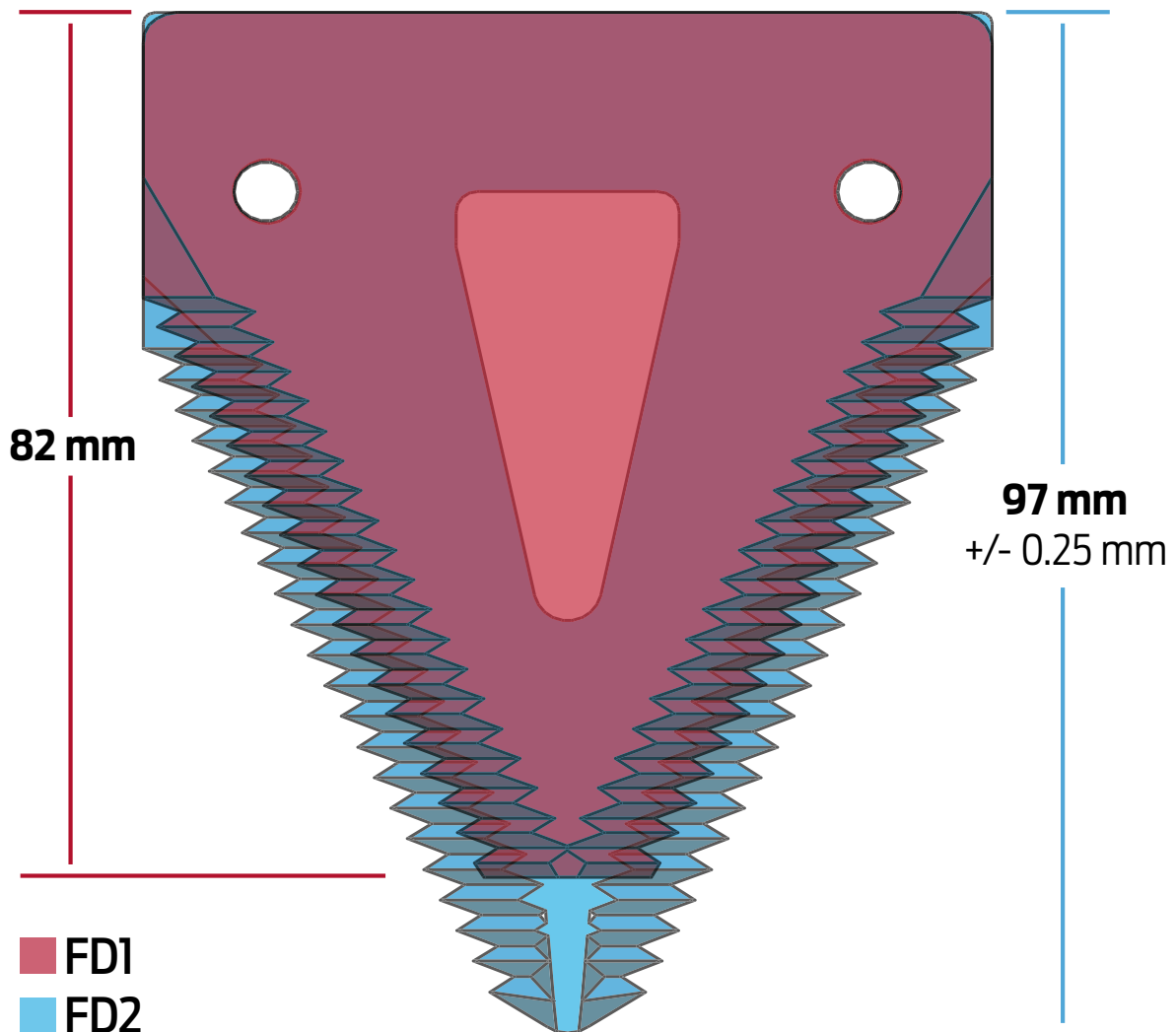

### CLEARCUT™ KNIFE SECTIONS

MacDon ClearCut™ knife sections feature over 25% more cutting surface thanks to a longer blade and improved geometry. So what does that mean for you? It means faster, cleaner cut quality at higher ground speeds.

#### *Stay Sharp!*

Another great advantage of this new cutting system is the redesigned hardware. Fitted bolts make in-field knife section replacement quick and easy.

**OVER**  
**25%<sup>+</sup>**  
**MORE**  
**CUTTING SURFACE**

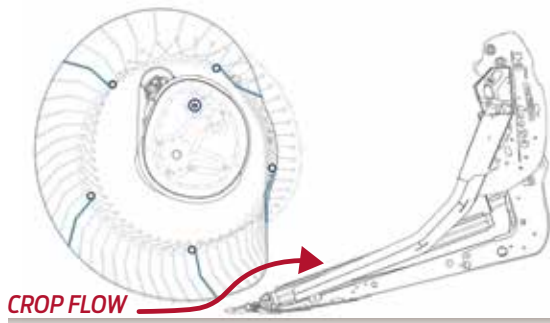

**CAM POSITION 1**

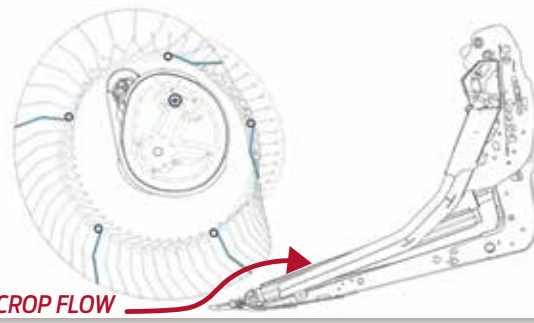

**CAM POSITION 2**

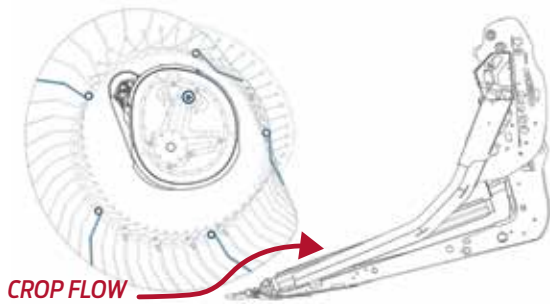

**CAM POSITION 3**

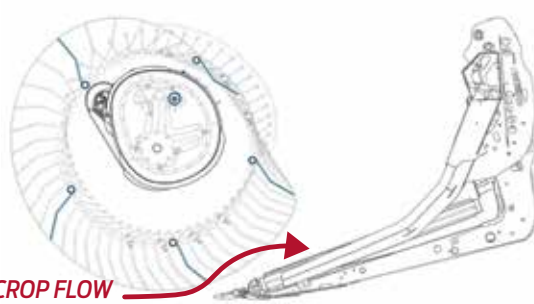

**CAM POSITION 4**

### **AMAZING REEL PERFORMANCE**

The unique movement of the D2 reel picks up and gently places crop onto the drapers. Our cam design allows the reel fingers to get down underneath lodged crop and pick it up before cutting. Aluminum reel ends and sectors help reduce overall weight and improve efficiency. The D2 header and reel are highly adjustable for optimal performance. Header reel functions controlled from the operator station (or "from within the cab") include reel raise and lower, reel fore and aft positioning and reel speed; setting you up for the most challenging real-world harvesting conditions.



**50"** = **20%<sup>MORE</sup>**  
**DEEPER DRAPER**      **CAPACITY**

**SUPER-SIZED CAPACITY**

MacDon D2 Series Drapers feature an ultra-deep deck featuring 50-inch (127 cm) deep drapers. These extra deep drapers boost performance in big, bushy, high-volume crops by up to 20%.

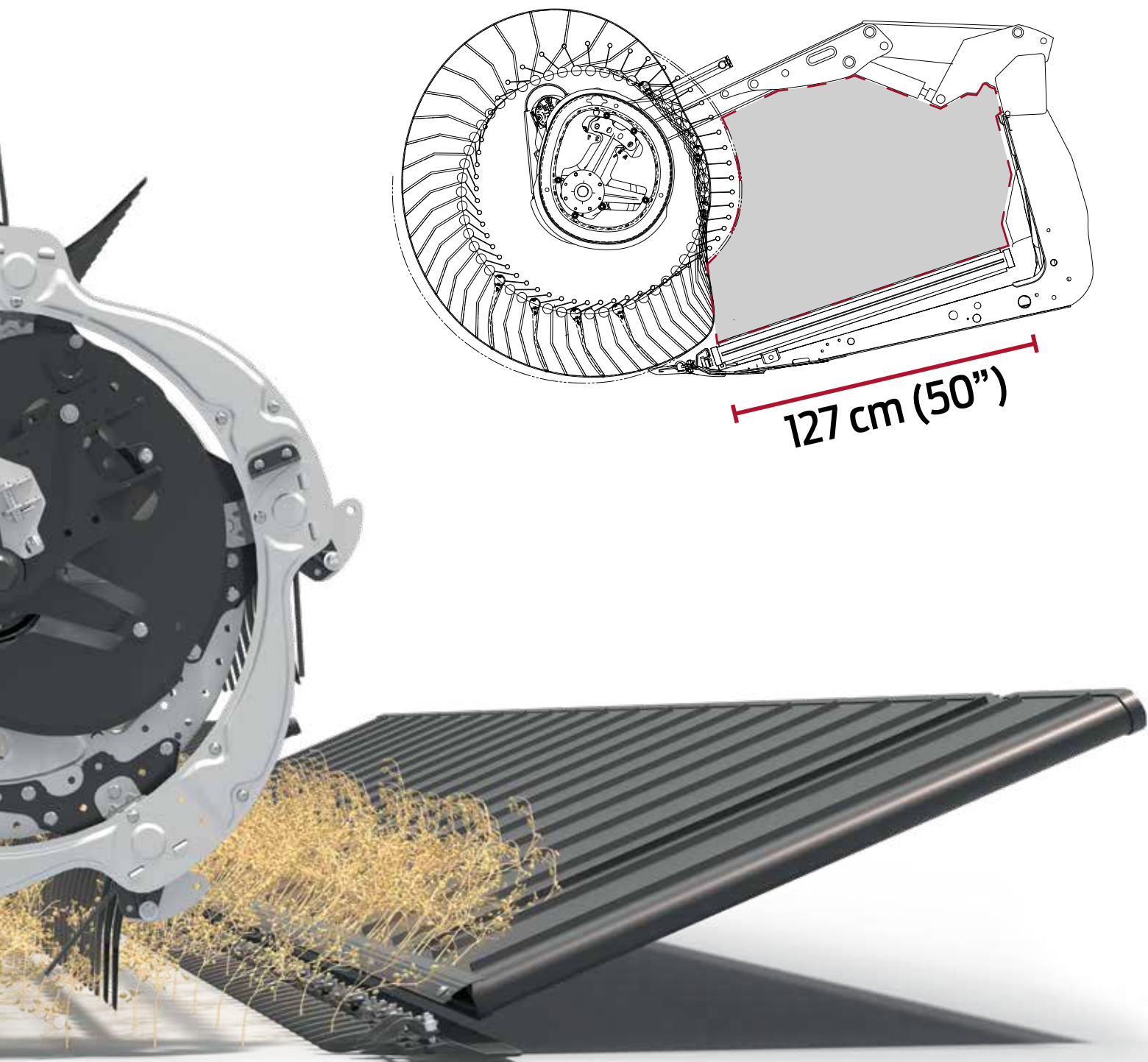

## DURABILITY

The D2 boasts a new frame featuring a super-structured five-sided back tube. This solid backbone is ready to handle the increased capacity of the deeper draper deck and ensures MacDon's rock-solid reliability.



### A CLEARCUT™ HIGH-SPEED KNIFE DRIVE

MacDon's direct knife drive satisfies your need for speed, providing more torque to power through the most challenging cutting conditions. In addition, the ETDK (Electronically Timed Double Knife) helps reduce header vibration, improving components' reliability and overall durability.

### B QUICK LATCH END DIVIDER SYSTEM

MacDon's Quick Latch End Divider System lets you hook and connect your divider in one move. When using VertiBlade™ Vertical Knives, the standard divider rods store neatly onboard.

### C FULL-LENGTH UPPER CROSS AUGER

A performance option worth considering for anyone harvesting big bushy, high-volume crops is the Upper Cross Auger. The auger keeps bushy crops on the draper as they move to the center of the header, where twin pitch flighting actively and aggressively drives the crop down into a window. This option runs the entire header length and is available on all sizes of the D2.

### D VERTIBLADE™ VERTICAL KNIVES

A performance option worth mentioning for anyone cutting in messy crops. The MacDon VertiBlade™ vertical knife reduces seed loss in tangled, shatter-prone crops like canola (rapeseed). The VertiBlade integrates seamlessly into the header design and is easy to install. Just hook on and connect in one move, hydraulics and all, with MacDon's Quick Latch End Divider System.





# TR SERIES Trailers

## Performance Header Transport.

Loading and transporting your MacDon headers just got a whole lot easier with MacDon TR Series Trailers. Specifically built for your MacDon header, the swan neck chassis design provides on-road precision for up to 40km/h (24mph) road speeds.\*

\*Always follow local traffic laws and regulations.

Only use towing vehicles rated to tow MacDon Trailers.

### TR SERIES TRAILER/HEADER COMPATIBILITY CHART

Header Size	TR25 Compatible Header Models
4.6 m (15')*	D65, D1, D1X, D2, PW8
6.1 m (20')*	D65, D1, D1X, D2
7.6 m (25')*	D65, D1, D1X, FD125, D2, FD225
C Series	Max header size = 12 row x 50.8 cm (20 in.) row spacing

\*D1 Headers equipped with a TM100 Tractor Mount can be used with MacDon Trailers.

TR SERIES  
WEBSITE







## 1 SPARE TIRE OPTION

Conveniently stored on-frame to quickly get you back on the road and in the field harvesting.

## 2 ON-FRAME STORAGE OPTIONS

An optional storage box is cleverly attached on-frame and allows storage of tools and performance options like crop dividers and crop lifters. A vertical knife storage rack is also available.

\*Always follow local traffic laws and regulations.  
Only use towing vehicles rated to tow MacDon Trailers.

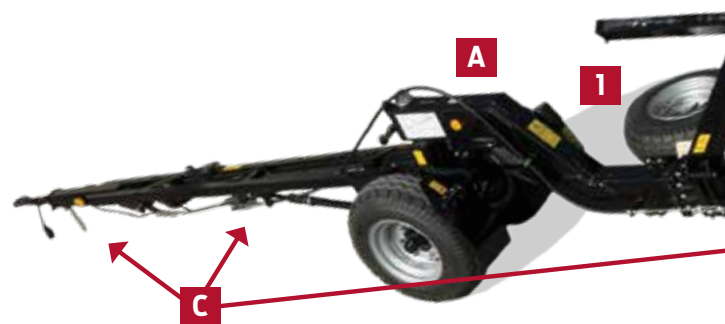





### A PRECISION TRANSPORT

The swan neck chassis design provides on-road precision, allowing the trailer to follow the towing vehicle's tracks closely. This design lets you handle tight roadways and crossings with confidence.



### B ROAD READY HOMOLOGATION

MacDon Trailers can be used with M2 Series Windrowers, Combines, Tractors, or Trucks. MacDon TR Series Trailers have EU homologation for 40km/h (24mph) and comply with European road standards.\*



### C HIT THE BREAKS

The inertia-activated brake activates the front and rear drum brakes via cable tension. Inertial braking allows for smooth handling of the trailer by the towing vehicle.

Trailers are equipped with a hand-activated park brake, wheel chocks, and on-frame wheel chock storage.

### D EASY ON. EASY OFF.

Loading and unloading your MacDon headers just got a whole lot easier with MacDon-specific header supports/hooks.

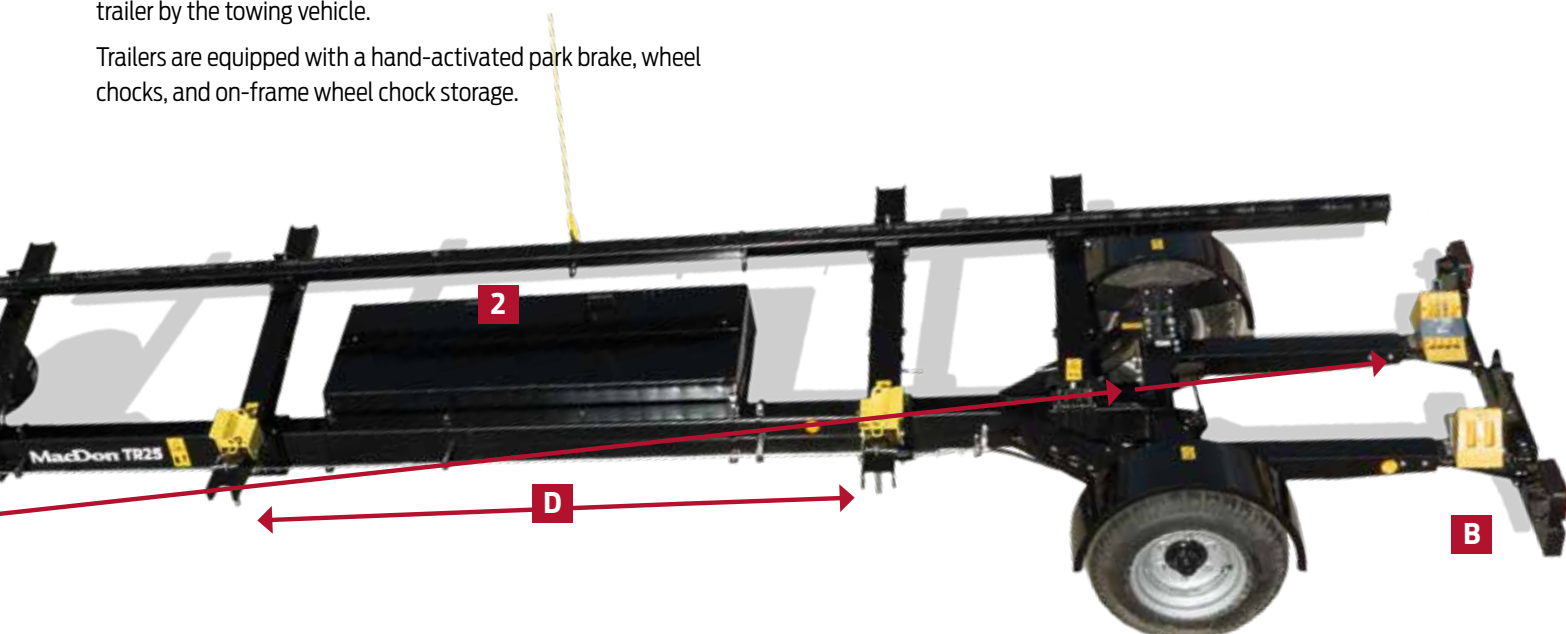

# SPECIFICATIONS

## M2 SERIES WINDROWER SPECIFICATIONS

	M2170	M2260	M2170NT
Engine	Cummins QSB4.5L 4 Cylinder Stage V Turbo Diesel (B20 bio-diesel approved)	Cummins QSB-6.7L 6 Cylinder Stage V Turbo Diesel (B20 bio-diesel approved)	Cummins QSB4.5L 4 Cylinder Stage V Turbo Diesel (B20 bio-diesel approved)
Horsepower	Rated 129 kW (173 hp) @ 2200 rpm	Rated 194 kW (260 HP) @ 2200 rpm Peak 209 kW (280 hp) @ 2000 rpm	Rated 129 kW (173 hp) @ 2200 rpm
Weight*	5942 kg (13100 lb)	6078 kg (13400 lb)	5942 kg (13100 lb)
Batteries / Alternator	2, 12 volt (Group 29H or 31A), 200 amp		
Fuel Tank / DEF Tank	518 L (137 US gal) / 49 L (13 US gal)	518 L (137 US gal) / 55 L (14.5 US gal)	518 L (137 US gal) / 49 L (13 US gal)
Front Track Width	3449 mm (135.8 in.)		2934 - 3294 mm (115.5 - 129.7 in.)
Rear Tread Width	2448 - 3856 mm (96.4 - 151.8 in.)		2666 - 3659 mm (105 - 144 in.)
Front Width	Tire Dependant		3489 mm (137.36 in.) road (transport), 3834 mm (150.9 in.) field
Wheel Base	4290 mm (168.9 in)		
Crop Clearance	1150 mm (45.28 in)		
Drive Wheels	600-65R28 bar; 580-70R26 turf		540-65R30
Tail Wheels	16.5L - 16.1 with independent suspension		
Transmission	Hydrostatic Infinitely Variable		
Field Speed	Up to 29 km/h (18 mph)		
Road (Transport) Speed	Up to 43.4 km/h (27 mph)		
Final Drive	Planetary gearbox		
Cab Equipment	Dual Direction® operator station, Ultra Glide® cab suspension		
Operator Station	<p><b>Standard Cab:</b> Bluetooth® equipped radio, windshield (sun) shades (front and rear), adjustable air ride suspension cloth operator seat, seat belt, fold away trainer seat, windshield wiper with washer fluid, auto climate control, warning beacons, tilt and telescoping steering column, 4 halogen road lights, 8 LED work lights.</p> <p><b>Deluxe Cab option adds:</b> Heated and vented leather high-back multi-adjustable air ride seat, seat belt, leather fold away training seat, power mirrors, 360° Night Vision from 8 high lumen LED work lights, *All M2170NTs will have a deluxe cab.</p>		
Harvest Performance Tracker	<b>Harvest Touch Display:</b> 17.8 cm (7") color LCD touch screen		
Instrumentation and Monitor System	Monitoring functions: <b>(1)</b> Speed: ground, knife, reel, conveyor, cooling fan <b>(2)</b> Pressure: knife, reel, conveyor <b>(3)</b> Header Position: height, tilt, float, reel height, reel fore/aft <b>(4)</b> Engine: RPM, fuel consumption, load		
Options	Center link Alignment Kit, Rear Ballast Weights, Weightbox and Harness for Header Transport, Float Booster Springs, Double Windrow Attachment (DWA), Swath Compressor, High Debris Cooler Kit, Block Heater.		
Factory Ordered	HD Wheel Drive Conversion		

\*Weight with 600-65R28 bar tires and 16.5L-16.1 suspended tail wheels. Hydraulic oil and coolant included in weight. Does not include fuel/DEF.

## D2 SERIES DRAPER HEADER SPECIFICATIONS

Size*	4.6 m (15')	6.1 m (20')	7.6 m (25')	9.1 m (30')	10.6 m (35')	12.5 m (41')	13.7 m (45')
Weight** Double Knife Drive	1689 kg (3723 lb)	1852 kg (4081 lb)	2163 kg (4768 lb)	2622 kg (5779 lb)	2843 kg (6266 lb)	3006 kg (6626 lb)	3127 kg (6893 lb)
Knife: Type / Drive / Speed	Double knife / Hydraulic, MacDon design enclosed oil bath knife drive boxes 1200 - 1800 spm, varies depending on header size						
Guard Type Available	Standard: ClearCut™ PlugFree™ Short Guards - Forged and Double Heat Treated (DHT) with Forged, Dual Bolt Adjustment Hold-Down						
Reel: Type / Drive / Speed / Fingers	Pick-up Reel, six or nine bats, one-piece (single) or two-piece (double), flip-over design, cam-leading finger control / Hydraulic / 0 to 85 rpm (auto-adjust from cab) / 290 mm (11.4") length, wear-resistant HD plastic, 102 mm (4") spacing						
Conveyor: Type / Drive / Speed / Delivery Opening	1270 mm [50"] Draper / Hydraulic / 0 - 250 m/min [822 ft/min] / 0 - 250 m/min [822 ft/min] / Delivery opening 15' -1395 - 1525 mm [54.9" - 60.0"]; 20', 25', 30', 35', 41' - 1775 - 1905 mm [69.9" - 75"]						
Field-Installed Options	Upper Cross Auger, VertiBlade™ Vertical Knife, Stabilizer wheels, Stubble Lights						

\*Product size availability varies by market

\*\*All listed weights are approximations and will vary depending on header configuration.

## TR SERIES TRAILERS - SPECIFICATIONS

Model	TR25
Weight	1710 kg (3770 lb)
Dimensions	Length: 12 m (39'4"); Width: 2.16 m (7'1")
Wheels/Brakes	P264-75 R15 radial tires; fender kit (option); inertial braking system; drum brakes; with reversing mechanism
Parking	Manual park brake; wheel chocks and wheel chock storage
Header Hookup	MacDon specific supports; adjustable alignment gauge; adjustable support arm with turnbuckles; support arms adjustable laterally; rear tie-down locations; lift-assisted tow bar
Legal	Homologated for European Union; 40 km/h (24 mph) road speed*
Storage	On-board storage box (option); On-board vertical knife storage rack (option)

\*Always follow local traffic laws and regulations. Only use towing vehicles rated to tow MacDon Trailers.

\*\*All listed weights are approximations and will vary depending on options installed.

## TR SERIES TRAILER/HEADER COMPATIBILITY CHART

Header Size	TR25 Compatible Header Models
4.6 m (15')*	D65, D1, D1X, D2, PW8
6.1 m (20')*	D65, D1, D1X, D2
7.6 m (25')*	D65, D1, D1X, FD125, D2, FD225
C Series	Max header size = 12 row x 50.8 cm (20 in.) row spacing

\*D1 Headers equipped with a TM100 Tractor Mount can be used with MacDon Trailers.

MACDON  
WEBSITE



## Keep your MacDon at peak performance with MacDon Performance Parts.

### *Parts Showcase:*

MacDon Performance Parts are designed to meet MacDon's demanding performance standards. They have been tested in the toughest real-world conditions, ensuring the worry-free harvest you've come to rely on with MacDon. They offer the added benefit of convenience and are engineered to be of the highest quality. Our genuine parts have been created with our customers in mind.

*Check out the latest offerings from MacDon Performance Parts...*

---



### *Be Prepared for Performance!*

MacDon Performance Parts Kits are designed for convenience. Choose from a variety of kits packed with common high wear items for your MacDon machines. Keep them on hand and ensure a smooth running harvest, every time.

### Annual Filter Kit

MacDon has your filter requirements covered with this convenience kit containing all of the filters you need for your first round of Windrower maintenance. Kits include air, hydraulic, fuel, and oil filters. Have these filters by your side and ready to go when it's time to do maintenance on your Windrower. Available for M105, M155, M155E4, M205, M1170, M1240, & M1170NT model windrowers.



### Draper Header Service Kit

Order one convenient parts kit containing high wear draper header replacement parts that are required by your MacDon header. Sickle sections, guards, wearplates, fingers and hardware are all included in this user-friendly kit. Draper Header Service Kits are available for MacDon FD2/D2/FD1/D1/FD75 and D1XL/D1X/D65 machines.



### Crop Lifter

Designed by MacDon, for your MacDon, genuine Crop Lifters lift lodged crop off the ground when crop has been flattened. MacDon crop lifters offer a custom fit specifically designed for MacDon headers, offering optimal performance through all header tilt angles.



### Knife Assembly Kit\*

MacDon Performance Parts Knife Assembly Kits include all knife segments and splice kits required to replace the complete knife on a header. Single Knife available in sizes from 7.6 to 12.2 m (20 to 40 foot), and Double Knife available in sizes from 9.1 to 13.7 m (20 to 50 foot) configurations for a wide range of MacDon Draper Header models.\*\*

\*Knife heads are sold separately

\*\*Available sizes vary for each MacDon model

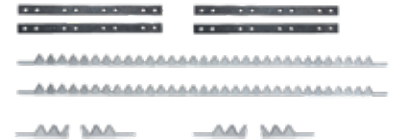

### Guard Kit\*

MacDon Performance Parts Guard Kits include all guards required to do a complete cutterbar replacement. Single Knife available in sizes from 9.1 to 12.2 m (25 to 40 foot), and Double Knife available in sizes from 9.1 to 13.7 m (25 to 50 foot) configurations for a wide range of MacDon Draper Header models.\*\*

\*Hardware sold separately

\*\*Available sizes vary for each MacDon model



### Rotary Disc Service Kit

Order Rotary Disc Service Kits from MacDon for one convenient package that contains all the high wear rotary disc replacement parts required for your machine. Available for R80, R85, R1, and R2 Rotary Disc Headers.



Learn more and find your local MacDon Dealer at [MacDonPerformanceParts.com](http://MacDonPerformanceParts.com)





MACDON  
WEBSITE



# MacDon®

*The Harvesting Specialists. MacDon.com*

Trademarks of products are the marks of their respective manufacturers and/or distributors. Specifications and options subject to change without notice. Products subject to availability. Products featured may include available options. **Windrowing Solutions - MY2024 - ENG A4 - 04-08-24 Part# 262368**