

# **M105**

# **Self-Propelled Windrower**

OPERATOR'S MANUAL

Part #169552 Rev. B

\$25

This Manual contains instructions for “SAFETY”, “OPERATION”, and “MAINTENANCE/SERVICE” for your new MacDon Model M105 Self-Propelled Windrower.



**CALIFORNIA**

**Proposition 65 Warning**

**Diesel engine exhaust and some of its constituents are known to the State of California to cause cancer, birth defects, and other reproductive harm.**

# 1 INTRODUCTION

This manual contains information on the Model M105 Self-Propelled Windrower that is designed to cut and lay in windrows, a wide variety of grain, hay and specialty crops. Windrowing allows starting the harvest earlier, protects the crop from wind damage, and gives you more flexibility in scheduling combine time.

The power unit (referred to in this manual as the windrower), when coupled with one of the specially designed auger or draper headers, provides a package that incorporates many features and improvements in design.

This manual must be used in conjunction with your Header Operator's Manual.

**CAREFULLY READ ALL THE MATERIAL PROVIDED BEFORE ATTEMPTING TO UNLOAD, ASSEMBLE, OR USE THE MACHINE.**

Use this manual as your first source of information about the machine. If you follow the instructions given in this manual, your M105 windrower will work well for many years.

If you require more detailed service information, check with your MacDon Dealer.

Use the Table of Contents and the Index to guide you to specific areas. Study the Table of Contents to familiarize yourself with how the material is organized.

Keep this manual handy for frequent reference, and to pass on to new Operators or Owners. A manual storage case is provided in the cab.

Contact your Dealer if you need assistance, information, or additional copies of this manual.

Published: December, 2011

## 2 MODEL AND SERIAL NUMBER

Record the Model Number, Serial Number, and Model Year of the Windrower and Engine on the lines below:

WINDROWER SERIAL NO. \_\_\_\_\_ YEAR \_\_\_\_\_

Serial Number Plate is located on the left side of the main frame near the walking beam.



ENGINE SERIAL NO. \_\_\_\_\_ YEAR \_\_\_\_\_

Serial Number Plate is located on top of the engine cylinder head cover.



# TABLE OF CONTENTS

Section/Title	Page
<b>1 INTRODUCTION</b> .....	<b>1</b>
<b>2 MODEL AND SERIAL NUMBER</b> .....	<b>2</b>
<b>3 SAFETY</b> .....	<b>7</b>
3.1 SAFETY ALERT SYMBOL .....	7
3.2 SIGNAL WORDS.....	7
3.3 SAFETY SIGNS.....	7
3.3.1 <i>Safety Sign Installation</i> .....	7
3.3.2 <i>Safety Sign Locations</i> .....	7
3.4 GENERAL SAFETY.....	12
<b>4 DESCRIPTION</b> .....	<b>14</b>
4.1 DEFINITIONS .....	14
4.2 SPECIFICATIONS.....	15
4.3 WINDROWER DIMENSIONS.....	17
4.4 COMPONENT IDENTIFICATION.....	19
<b>5 OPERATOR'S STATION</b> .....	<b>20</b>
5.1 OPERATOR CONSOLE.....	20
5.2 SEAT ADJUSTMENTS.....	20
5.3 TRAINING SEAT (Optional) .....	21
5.4 SEAT BELTS .....	21
5.5 STEERING COLUMN ADJUSTMENT .....	21
5.6 OPERATOR PRESENCE.....	22
5.6.1 <i>Header Drive</i> .....	22
5.6.2 <i>Transmission</i> .....	22
5.6.3 <i>Engine</i> .....	22
5.7 LIGHTS.....	23
5.7.1 <i>Field Lighting</i> .....	23
5.7.2 <i>Road Lighting</i> .....	24
5.7.3 <i>Beacon Lighting: Export (N.A. Optional)</i> .....	24
5.8 WINDSHIELD WIPER .....	25
5.9 REAR VIEW MIRRORS.....	25
5.10 CAB TEMPERATURE .....	26
5.10.1 <i>Controls</i> .....	26
5.10.2 <i>Air Distribution</i> .....	26
5.10.3 <i>Heater Shut-Off Valve</i> .....	26
5.10.4 <i>A/C Compressor Protection</i> .....	27
5.11 INTERIOR LIGHTS.....	27
5.12 OPERATOR AMENITIES .....	27
5.13 RADIOS.....	28
5.13.1 <i>AM/FM Radio</i> .....	28
5.13.2 <i>Antenna Mounting</i> .....	28
5.14 HORN .....	28
5.15 ENGINE CONTROLS .....	29
5.16 WINDROWER CONTROLS .....	29
5.17 HEADER CONTROLS.....	30
5.17.1 <i>Header Drive Switch</i> .....	30
5.17.2 <i>Deck Shift - Draper Header Option</i> .....	30
5.17.3 <i>GSL Header Switches</i> .....	30
5.18 CAB DISPLAY MODULE (CDM).....	32

# TABLE OF CONTENTS

Section/Title	Page
5.18.1 Engine and Windrower Functions .....	32
5.18.2 Header Functions.....	32
5.18.3 Operating Screens .....	33
5.18.4 Cab Display Module (CDM) Warnings/Alarms .....	38
5.18.5 Cab Display Module (CDM) Programming .....	41
5.18.6 Engine Error Codes.....	47
5.18.7 CDM and WCM Fault Codes.....	47
<b>6 OPERATION .....</b>	<b>48</b>
6.1 OWNER/OPERATOR RESPONSIBILITIES.....	48
6.2 SYMBOL DEFINITIONS .....	48
6.2.1 Engine Functions .....	48
6.2.2 Windrower Operating Symbols.....	49
6.2.3 Header Functions.....	49
6.3 WINDROWER OPERATION .....	50
6.3.1 Operational Safety .....	50
6.3.2 Break-In Period .....	50
6.3.3 Daily Check.....	51
6.3.4 Engine Operation .....	52
6.3.5 Driving The Windrower.....	56
6.3.6 Adjustable Caster Tread Width .....	60
6.3.7 Transporting.....	62
6.3.8 Towing the Windrower .....	71
6.3.9 Storage.....	72
6.4 HEADER OPERATION.....	73
6.4.1 Header Lift Cylinder Stops .....	73
6.4.2 Header Flotation.....	74
6.4.3 Levelling.....	76
6.4.4 Header Drive.....	77
6.4.5 Header Angle .....	77
6.4.6 Cutting Height .....	79
6.4.7 Swath Roller Operation .....	80
6.5 D SERIES HEADER OPERATION.....	81
6.5.1 Configure Hydraulics.....	81
6.5.2 Attach Header Boots .....	81
6.5.3 Header Attachment .....	82
6.5.4 Header Position.....	85
6.5.5 Reel Fore-Aft Position .....	85
6.5.6 Reel Height .....	85
6.5.7 Reel Speed .....	86
6.5.8 Draper Speed.....	88
6.5.9 Knife Speed.....	90
6.5.10 Deck Shift (Optional).....	91
6.5.11 Header Detachment .....	92
6.6 A SERIES HEADER OPERATION .....	94
6.6.1 Header Attachment .....	94
6.6.2 Auger Speed .....	97
6.6.3 Reel Speed .....	98
6.6.4 Knife Speed.....	99
6.6.5 Header Detachment .....	101
<b>7 MAINTENANCE AND SERVICING .....</b>	<b>103</b>
7.1 PREPARATION FOR SERVICING.....	103
7.1.1 Welding Precautions .....	103
7.2 RECOMMENDED SAFETY PROCEDURES .....	103
7.3 MAINTENANCE SPECIFICATIONS.....	104

# TABLE OF CONTENTS

Section/Title	Page
7.3.1 Recommended Torques .....	104
7.3.2 Recommended Fuel, Fluids And Lubricants .....	107
7.3.3 Conversion Chart.....	108
<b>7.4 MAINTENANCE REQUIREMENTS .....</b>	<b>109</b>
7.4.1 Maintenance Schedule / Record.....	110
7.4.2 Break-In Inspections .....	112
7.4.3 Pre-Season/Annual Service.....	113
7.4.4 End of Season Service .....	114
7.4.5 Lubrication .....	114
<b>7.5 ENGINE COMPARTMENT HOOD .....</b>	<b>117</b>
<b>7.6 MAINTENANCE PLATFORM.....</b>	<b>118</b>
7.6.1 Opening/Closing Platform.....	118
7.6.2 Opening/Closing Platform for Major Servicing .....	118
<b>7.7 OPERATOR'S STATION.....</b>	<b>120</b>
7.7.1 Seat Belts .....	120
7.7.2 Safety Systems .....	120
7.7.3 GSL Adjustments.....	121
7.7.4 Steering Adjustments.....	123
7.7.5 Neutral Start Switch .....	124
7.7.6 HVAC System.....	125
<b>7.8 ENGINE .....</b>	<b>128</b>
7.8.1 General Engine Inspection.....	128
7.8.2 Manually Turning Engine .....	128
7.8.3 Oil Level.....	129
7.8.4 Changing Oil and Oil Filter.....	130
7.8.5 Air Intake System.....	131
7.8.6 Fuel System.....	134
7.8.7 Engine Cooling System.....	138
7.8.8 Gearbox.....	141
7.8.9 Exhaust System.....	143
7.8.10 Belts.....	144
7.8.11 Engine Speed .....	145
<b>7.9 COOLING BOX.....</b>	<b>146</b>
7.9.1 Cooling Box Screen .....	146
7.9.2 Rotor To Screen Clearance .....	147
7.9.3 Cooling Box Maintenance.....	148
<b>7.10 ELECTRICAL SYSTEM.....</b>	<b>151</b>
7.10.1 Batteries.....	151
7.10.2 Headlights.....	157
7.10.3 Field Lights: Forward .....	158
7.10.4 Flood Lights: Forward .....	159
7.10.5 Flood Lights: Rear.....	160
7.10.6 Swath Lights .....	161
7.10.7 Amber Lights.....	162
7.10.8 Beacons (If Installed) .....	162
7.10.9 Dome Light .....	164
7.10.10 Ambient Light.....	164
7.10.11 Turn Signal Indicators.....	164
7.10.12 Circuit Breakers and Fuses.....	165
<b>7.11 HYDRAULIC SYSTEM .....</b>	<b>168</b>
7.11.1 Oil Level.....	168
7.11.2 Changing Hydraulic Oil .....	169
7.11.3 Changing Hydraulic Oil Filters .....	169
7.11.4 Header and Reel Hydraulics.....	170

## TABLE OF CONTENTS

Section/Title	Page
7.11.5 Traction Drive Hydraulics .....	172
7.11.6 Hoses and Lines .....	173
7.11.7 Hydraulic Oil Cooler .....	173
<b>7.12 WHEELS AND TIRES .....</b>	<b>174</b>
7.12.1 Drive Wheels.....	174
7.12.2 Caster Wheels.....	177
<b>8 TROUBLESHOOTING .....</b>	<b>181</b>
8.1 ENGINE .....	181
8.2 ELECTRICAL.....	184
8.3 HYDRAULICS.....	184
8.4 HEADER DRIVE.....	185
8.5 TRACTION DRIVE .....	185
8.6 STEERING AND GROUND SPEED CONTROL.....	187
8.7 CAB AIR.....	187
8.8 OPERATOR'S STATION.....	189
<b>9 OPTIONS / ATTACHMENTS.....</b>	<b>190</b>
9.1 REEL DRIVE AND LIFT PLUMBING .....	190
9.2 WINDROWER HYDRAULIC COMPLETION FOR DRAPER HEADER REEL FORE-AFT .....	190
9.3 BOOSTER SPRING KIT.....	190
9.4 INTERNAL BOOSTER SPRING KIT.....	190
9.5 LIGHT HEADER FLOTATION KIT .....	190
9.6 AM-FM RADIO.....	190
9.7 HYDRAULIC CENTER-LINK.....	190
9.8 FAN AIR BAFFLE KIT .....	190
9.9 TRAINING SEAT .....	190
9.10 KNIFE SPEED, REEL SPEED INDEX, AND TILT SENSOR MODULE .....	190
9.11 ANTI-SHIMMY KIT FOR CASTERS.....	190
9.12 SWATH ROLLER .....	190
9.13 WARNING BEACONS.....	190
9.14 AUTO-STEER.....	190
9.15 ENGINE BLOCK HEATER .....	190
9.16 TRANSPORT DRAWBAR .....	191
9.17 WEIGHT BOX.....	191
9.18 WINDSHIELD SHADES .....	191
9.19 HID AUXILLIARY LIGHTING.....	191
<b>INDEX .....</b>	<b>192</b>
<b>CDM/WCM FAULT CODES .....</b>	<b>195</b>
<b>ENGINE ERROR CODES.....</b>	<b>197</b>



## SAFETY

### 3 SAFETY

#### 3.1 SAFETY ALERT SYMBOL



This safety alert symbol indicates important safety messages in this manual and on safety signs on the machine.

This symbol means:

**ATTENTION!  
BECOME ALERT!  
YOUR SAFETY IS INVOLVED!**

Carefully read and follow the safety message accompanying this symbol.

WHY IS SAFETY IMPORTANT TO YOU?

**ACCIDENTS DISABLE AND KILL.  
ACCIDENTS COST.  
ACCIDENTS CAN BE AVOIDED.**

#### 3.2 SIGNAL WORDS

Note the use of the signal words **DANGER**, **WARNING**, and **CAUTION** with safety messages. The appropriate signal word for each message has been selected using the following guidelines:



**DANGER**

**Indicates an imminently hazardous situation that, if not avoided, will result in death or serious injury.**



**WARNING**

**Indicates a potentially hazardous situation that, if not avoided, could result in death or serious injury. It is also used to alert against unsafe practices.**



**CAUTION**

**Indicates a potentially hazardous situation that, if not avoided, may result in minor or moderate injury. It is also used as a reminder of good safety practices.**

#### 3.3 SAFETY SIGNS

##### 3.3.1 Safety Sign Installation

Proceed as follows:

- Be sure the installation area is clean and dry.
- Decide on the exact location before you remove the decal backing paper.
- Remove the smaller portion of the split backing paper.
- Place the sign in position, and slowly peel back the remaining paper, smoothing the sign as it is applied.
- Small air pockets can be smoothed out or pricked with a pin.

##### 3.3.2 Safety Sign Locations

The safety signs (decals) appear on the windrower at the locations approximately as shown.

- Keep safety signs clean and legible at all times.
- Replace safety signs that are missing or become illegible.
- If original parts on which a safety sign was installed are replaced, be sure the repair part also bears the current safety sign.
- Safety signs are available from your Dealer Parts Department.

# SAFETY

## Safety Sign Locations (cont'd)



ON SEAT BACK #115148

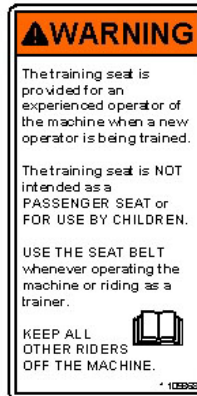

IN CAB #109868

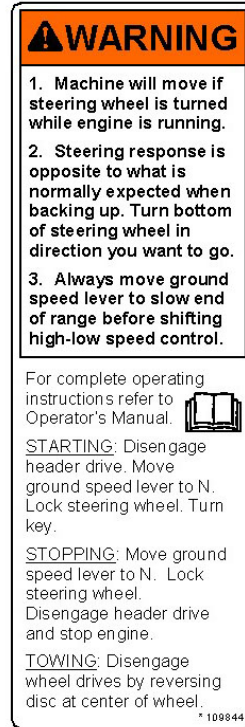

IN CAB #109844



BELOW WINDOW RELEASE #32744

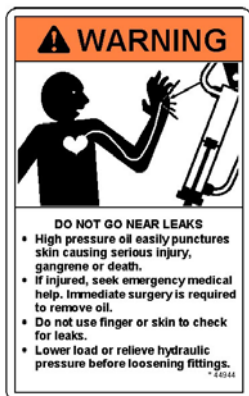
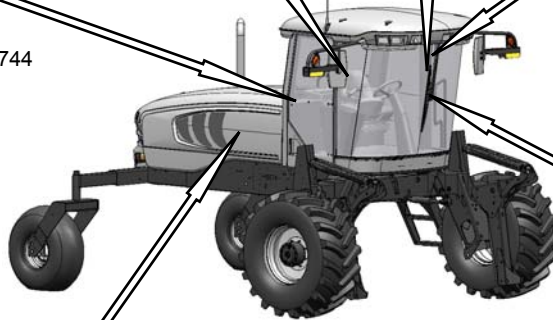

ON OIL RESERVOIR UNDER HOOD (BOTH SIDES) #44944

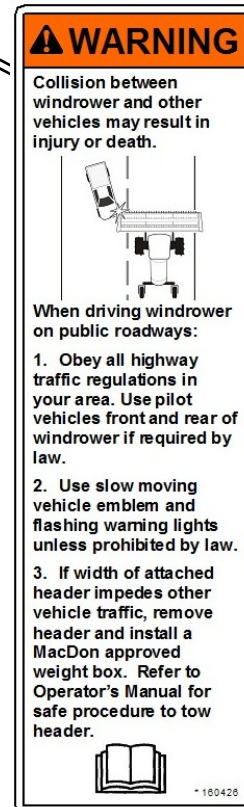

IN CAB #160422

# SAFETY

## Safety Sign Locations (cont'd)



IN CAB #32744



BELOW DOOR HANDLE #32744

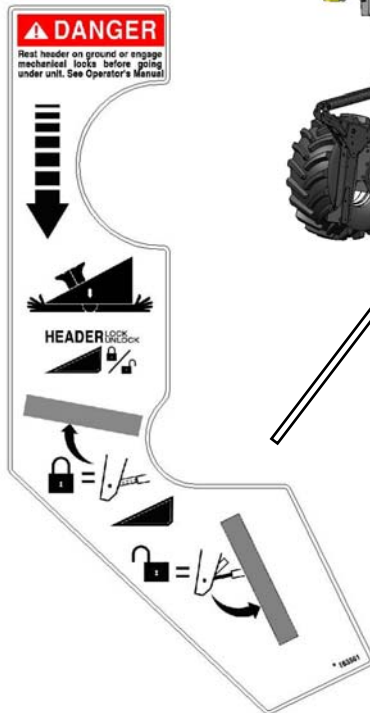

LIFT LINKAGES #163561

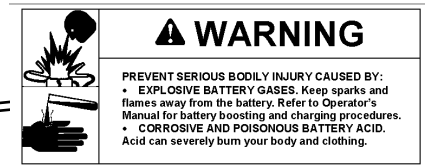

ON FRAME #110989

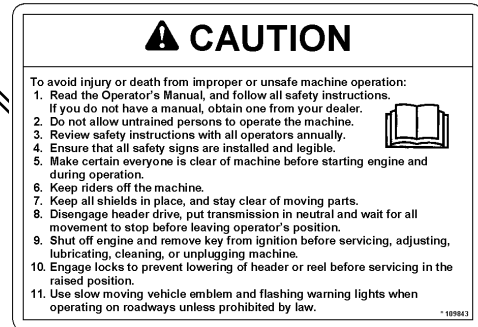

BEHIND DOOR ON SILL #109843

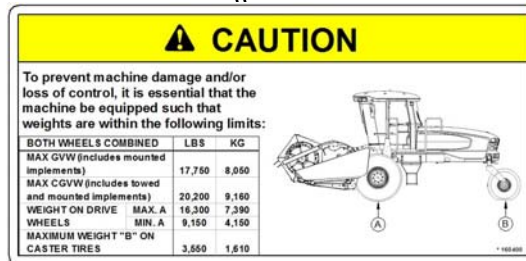

BEHIND DOOR ON SILL - LH SIDE ONLY #160400

# SAFETY

## Safety Sign Locations (cont'd)

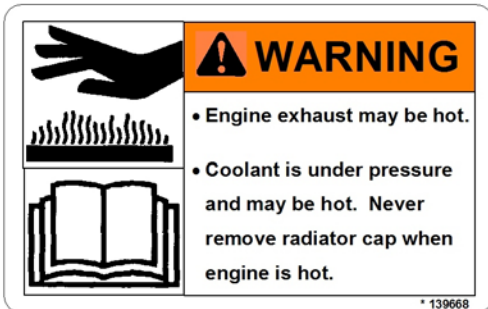

EXHAUST COVER #139668

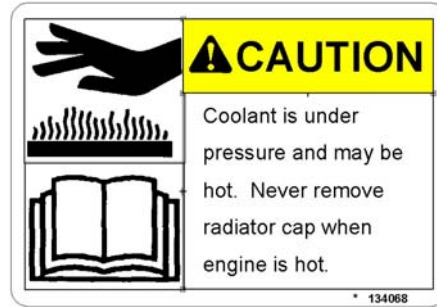

ON FAN SHROUD #134068

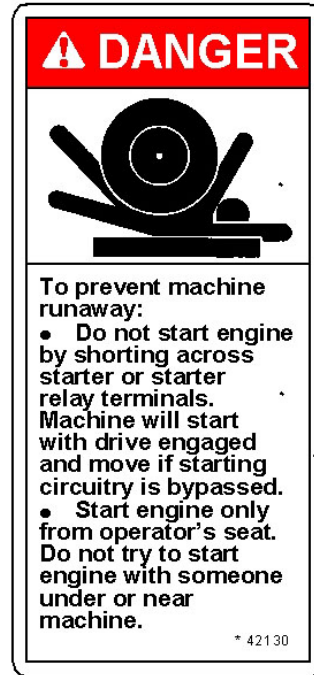
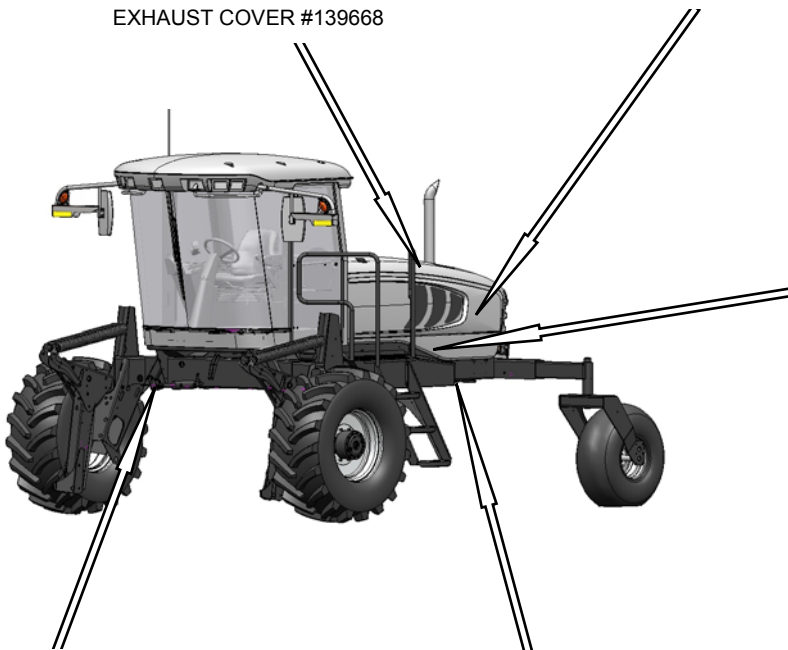

ON FRAME #42130

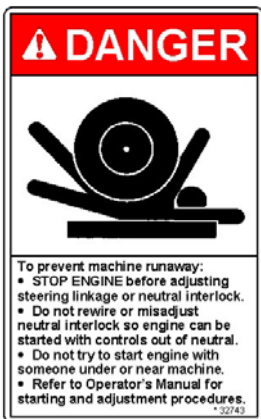

ON FRAME #32743



ON FRAME #110986

# SAFETY

## Safety Sign Locations (cont'd)



ON FRAME #110986

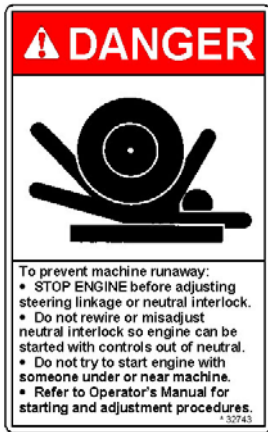
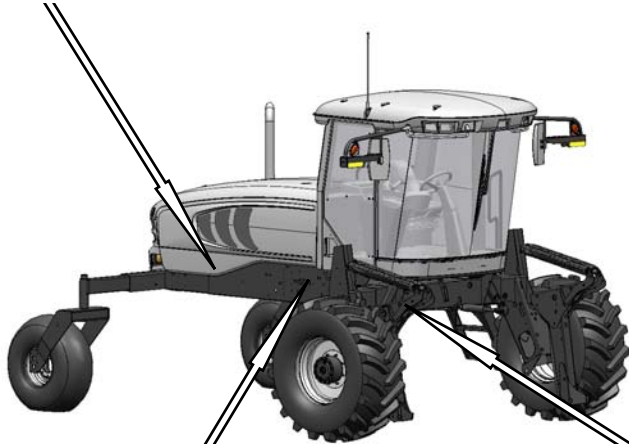

ON TRACTION PUMP  
#32743

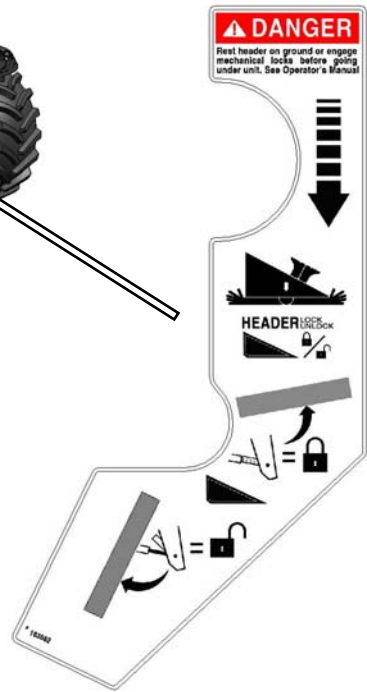

ON LIFT LINKAGE #163562

3.4 GENERAL SAFETY

 CAUTION

The following are general farm safety precautions that should be part of your operating procedure for all types of machinery.

Protect yourself.

- When assembling, operating and servicing machinery, wear all the protective clothing and personal safety devices that COULD be necessary for the job at hand. Don't take chances.
- You may need:

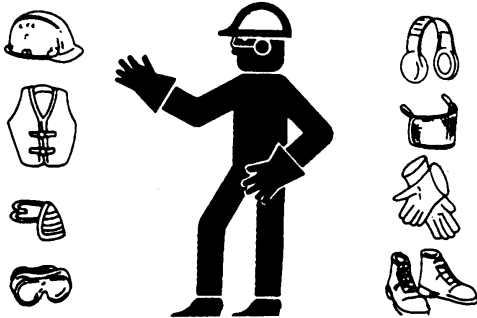

- a hard hat.
- protective shoes with slip resistant soles.
- protective glasses or goggles.
- heavy gloves.
- wet weather gear.
- respirator or filter mask.

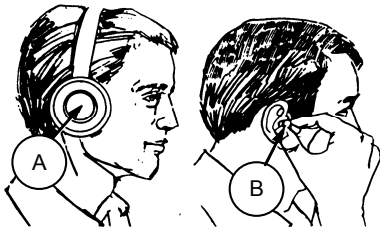

- hearing protection. Be aware that prolonged exposure to loud noise can cause impairment or loss of hearing. Wearing a suitable hearing protective device such as ear muffs (A) or ear plugs (B) protects against objectionable or loud noises.



- Provide a first-aid kit for use in case of emergencies.
- Keep a fire extinguisher on the machine. Be sure the extinguisher is properly maintained, and be familiar with its proper use.
- Keep young children away from machinery at all times.
- Be aware that accidents often happen when the Operator is tired or in a hurry to get finished. Take the time to consider the safest way. Never ignore warning signs of fatigue.
- Wear close-fitting clothing and cover long hair. Never wear dangling items such as scarves or bracelets.
- Keep hands, feet, clothing and hair away from moving parts. Never attempt to clear obstructions or objects from a machine while the engine is running.

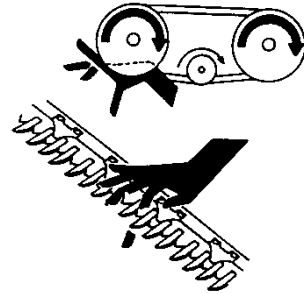

- Keep all shields in place. Never alter or remove safety equipment. Make sure driveline guards can rotate independently of the shaft and can telescope freely.
- Use only service and repair parts made or approved by the equipment manufacturer. Substituted parts may not meet strength, design, or safety requirements.

(continued next page)

## SAFETY

- Do not modify the machine. Unauthorized modifications may impair the function and/or safety and affect machine life.
- Stop engine, and remove key from ignition before leaving Operator's seat for any reason. A child or even a pet could engage an idling machine.



- Keep the area used for servicing machinery clean and dry. Wet or oily floors are slippery. Wet spots can be dangerous when working with electrical equipment. Be sure all electrical outlets and tools are properly grounded.
- Use adequate light for the job at hand.
- Keep machinery clean. Straw and chaff on a hot engine are a fire hazard. Do not allow oil or grease to accumulate on service platforms, ladders or controls. Clean machines before storage.
- Never use gasoline, naphtha or any volatile material for cleaning purposes. These materials may be toxic and/or flammable.
- When storing machinery, cover sharp or extending components to prevent injury from accidental contact.

## DESCRIPTION

### 4 DESCRIPTION

#### 4.1 DEFINITIONS

The following terms/abbreviations may be used in this manual:

TERM	DEFINITION
<b>API</b>	American Petroleum Institute
<b>APT</b>	Articulating Power Tongue
<b>ASTM</b>	American Society Of Testing and Materials
<b>Cab-Forward</b>	Windrower operation with the Operator and cab facing in the direction of travel.
<b>CDM</b>	Cab Display Module
<b>Center-link</b>	A hydraulic cylinder or turnbuckle type link between the header and the machine that tilts the header.
<b>ECM</b>	Engine Control Module.
<b>GSL</b>	Ground Speed Lever
<b>Header</b>	A machine that cuts and lays crop into a windrow, and is attached to a self-propelled windrower.
<b>ISC</b>	Intermediate Speed Control.
<b>Mower Conditioner</b>	A machine that cuts and conditions hay, and is pulled by an Ag tractor.
<b>PTO</b>	Power Take-Off
<b>SAE</b>	Society Of Automotive Engineers
<b>Self-Propelled Windrower (SP)</b>	Self-propelled machine consisting of a power unit with a header and/or conditioner.
<b>Tractor</b>	Ag type tractor.
<b>Truck</b>	A four-wheel highway/road vehicle weighing no less than 7500 lb (3400 kg).
<b>Windrower</b>	Power unit of a self-propelled header.
<b>WCM</b>	Windrower Control Module



## DESCRIPTION

### 4.2 SPECIFICATIONS

<b>ENGINE</b>			
Type	Cummins QSB - 4.5L 4 Cylinder Turbo Diesel. Bio-Diesel Approved.		
Displacement	275 cu. in. (4.5 L)		
Power	Rated	110 hp (81 kW) @ 2500 rpm	
	Peak	115 hp (86 kW) @ 2300 rpm	
Bore	4.21 in (107 mm)		
Stroke	4.88 in. (124 mm)		
Maximum RPM (no load) - header not engaged	2270 - 2330		
Idle RPM	1100		
<b>ELECTRICAL SYSTEM</b>			
Recommended Battery (2)	12 Volt, Min. 650CCA. Group Rating 29H or 31A. Heavy Duty / Off Road / Vibration Resistant.		
Alternator	130 amp		
Starter	Dry Type		
Working Lights	11		
<b>TRACTION DRIVE</b>			
Type	Hydrostatic, 2 Speed Electric Shift		
Speed	Field (Cab-Forward)	Low Range 0 - 11 mph (18 km/h)	
	Reverse (Cab-Forward)	6 mph (9.6 km/h)	
	Transport (Cab-Forward)	High Range 0 - 16 mph (26 km/h)	
Transmission	Type	2 Piston Pumps - 1 per Drive Wheel.	
	Displacement	3.0 cu. in. (50 cc)	
	Flow	33 U.S. gpm (125 L/min)	
	Pressure	5000 psi (345 bar)	
Final Drive	Type	Planetary Gearbox	
	Ratio	41.42 : 1	
Wheel Motor Displacement	Low Range	2.80 cu. in. (46 cc)	
	High Range	1.65 cu. in. (27 cc)	
<b>SYSTEM CAPACITIES</b>			
Fuel Tank	97 U.S. Gallons (367 L)		
Cooling	6.3 U.S. Gallons (24 L)		
Hydraulic Reservoir	11.5 U.S. Gallons (44 L)		
<b>HEADER DRIVE</b>			
	Piston Pump A	Gear Pump B	Gear Pump C
Type	Hydraulic, Load Sensing Control		
Displacement	0 - 3.0 cu. in. (49 cc.)	0 - 1.02 cu. in. (16.7 cc.)	0 - 1.02 cu. in. (16.7 cc.)
Flow	0 - 30 gpm (0 - 114 L/min)	0 - 11.5 gpm (0 - 44 L/min)	0 - 11.5 gpm (0 - 44 L/min)
Pressure	4000 psi (276 bar)	2900 psi (200 bar)	2900 psi (200 bar)
Function	Knife / Conditioner	Reel Drive	Conveyor / DWA

*(continued next page)*

## DESCRIPTION

<b>HEADER LIFT / TILT / FLOAT</b>					
Type		Hydraulic Double Acting Cylinders. Tilt - Optional Hydraulic Positioning, Optional Mechanical Link			
Gear Pump	Displacement	1.02 cu. in. (16.7 cc)			
	Flow	11.5 gpm (44 L/min)			
	System Pressure (Relief/Max)	2500 psi (172 bar)			
	Function	Lift / Tilt / Float			
<b>HEADER FLOTATION</b>					
Primary Adjustment		Manual, External, Draw-Bolt With Springs (1 per side). Inner Booster Spring On Each Side.			
<b>CAB</b>					
Type		Rubber Isolation			
Dimensions	Width	63 in. (1600 mm)			
	Depth	68.3 in. (1735 mm) (at top of window)			
	Height	64.6 in. (1640 mm)			
	Volume	125 cu. ft. (3540 L)			
Seat	Driver	Adjustable Mechanical Suspension, Seat Belt			
	Training	Optional Folding, Cab Mounted, Seat Belt			
Windshield Wiper		31.5 in. (800 mm) Blade			
Heater		24,000 Btu/h (7038 W)			
Air Conditioning		28,280 Btu/h (8288 W)			
Electrical Outlets (3)		One Live, One On Ignition, One Dual (Live / Keyed)			
Mirrors		Two Outside			
Radio		Two Speakers and Antenna Factory Installed. Radio Dealer Installed.			
<b>SYSTEM MONITORING</b>					
Speeds		Ground (mph or km/h), Engine (rpm), Knife (spm) Optional, Reel (rpm or mph / km/h) Optional, Conveyor (Ref. No.)			
Header		Height, Angle (Optional)			
<b>TIRE OPTIONS</b>					
Drive Tires	18.4 – 26 Bar	600 – 65 R28 Bar	18.4 – 26 Turf	23.1 – 26 Turf	580 / 70 R26 Turf
	32 psi (221 kPa)	26 psi (179 kPa)	35 psi (241 kPa)	20 psi (138 kPa)	24 psi (165 kPa)
Rear Tires		All Rear Tire Pressures are 10 psi (69 kPa) Formed Caster: 7.5 - 16SL Single Rib, 10 - 16 Front Steer Tire Forked Caster: 16.5L - 16.1 Rib Implement Flotation, 10 - 16 Front Steer Tire			
<b>FRAME AND STRUCTURE</b>					
Dimensions		Refer to Section 4.3 WINDROWER DIMENSIONS			
Frame to Ground (Crop Clearance)		45.7 in. (1160 mm)			
Weight	Base (less tires and options)	8820 lb. (4000 kg)			
	Max GVW	17,750 (8,050 kg)			
	Max CGWW	20,200 lb (9,160 kg)			
NG Header Compatibility		A30-S and A40-D Auger, D50 Harvest Header, D60 Harvest Header up to 35 FT			

NOTES: 1. Specifications and design are subject to change without notice or obligation to revise previously sold units.  
2. Weights do not include options.

## DESCRIPTION

### 4.3 WINDROWER DIMENSIONS

See Illustration on Next Page.

	WHEEL POSITION	TREAD Inch/mm	HUBS Inch/mm	CASTERS Inch/mm	TIRES Inch/mm	SHIPPING Inch/mm	WHEEL BASE Inch/mm	
							FORWARD	REVERSE
<b>DRIVE TIRES</b>								
<b>18.4 x 26 Bar and Turf Rims Inset *</b>	Inner/Outer	123.1/3127	139.1/3532	---	142.2/3612	142.9/3630	158.3/4020	120.6/3064
	Outer/Outer	130.2/3307	146.1/3712		149.3/3792			
	Inner/Inner	116/2947	131.9/3352		135.1/3432			
<b>18.4 x 26 Bar and Turf Rims Outset †</b>	Inner/Outer	130.1/3305	139.1/3532	---	149.2/3790	142.9/3630	158.3/4020	120.6/3064
	Outer/Outer	137.2/3484	146.1/3712		156.3/3970			
	Inner/Inner	123/3124	131.9/3352		142.1/3610			
<b>600/65R28 Radial Tire</b>	Inner/Outer	130.1/3305	139.1/3532	---	153.7/3904	142.9/3630	158.3/4020	120.6/3064
	Outer/Outer	137.2/3484	146.1/3712		160.9/4084			
	Inner/Inner	123/3124	131.9/3352		146.6/3724			
<b>23.1 - 26 and 580/70R26 Turf Tires</b>	Inner/Outer	127.2/3230	139.1/3532	---	150/3810	142.9/3630	158.3/4020	120.6/3064
	Outer/Outer	134.2/3410	146.1/3712		157.1/3990			
	Inner/Inner	120.1/3050	131.9/3352		142.9/3630			
<b>CASTER TIRES</b>								
<b>7.5 - 16SL</b>	Minimum	96.4/2448	---	119.4/3032				
	Maximum	135.7/3448		158.8/4032				
<b>10 - 16 Formed Caster</b>	Minimum	96.4/2448	---	119.4/3032				
	Maximum	135.7/3448		158.8/4032				
<b>10 - 16 Forked Caster</b>	Minimum	96.4/2448	---	118.7/3014				
	Maximum	135.7/3448		158.0/4014				
<b>16.5 x 16.1</b>	Minimum	96.4/2448	---	118.7/3014				
	Maximum	135.7/3448		158.0/4014				

\* Allows for clearance with 15 FT D Series Header.

† Provides extra clearance to the frame in muddy conditions.

# DESCRIPTION

## WINDROWER DIMENSIONS (cont'd)

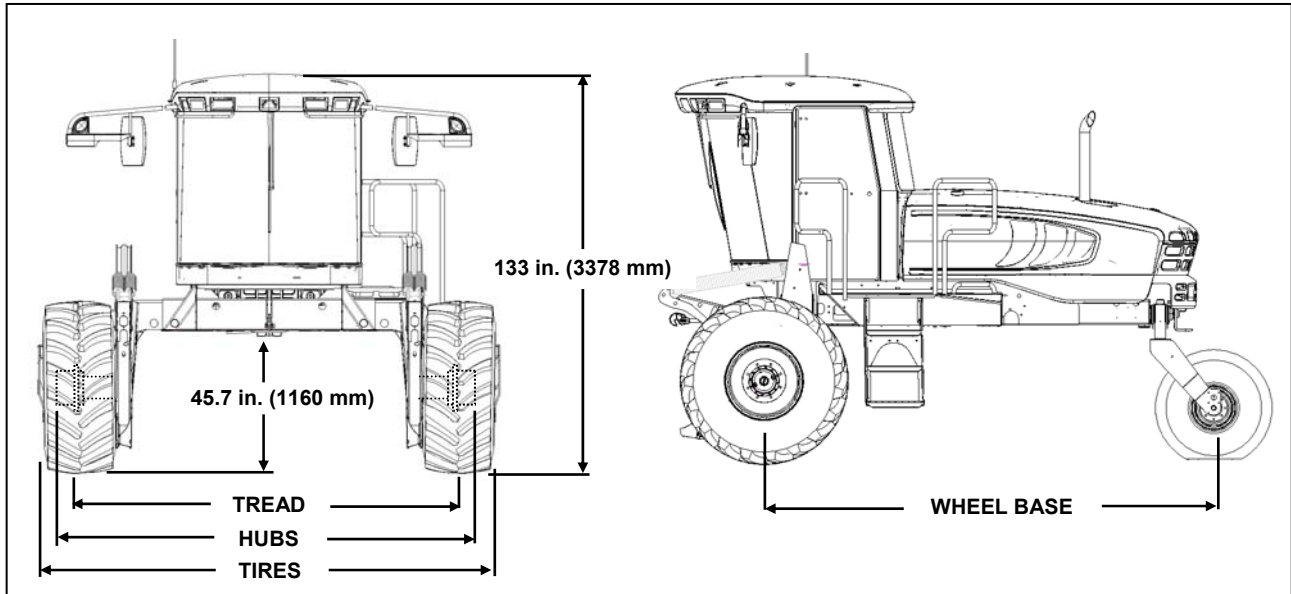

FORWARD

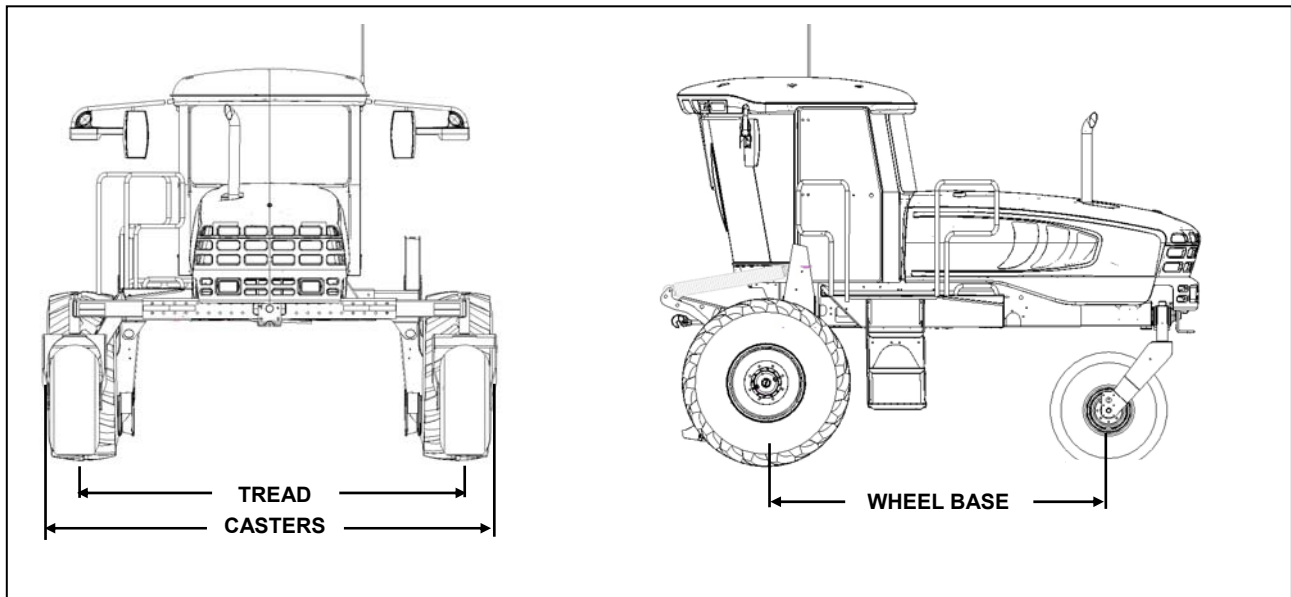

REVERSE

# DESCRIPTION

## 4.4 COMPONENT IDENTIFICATION

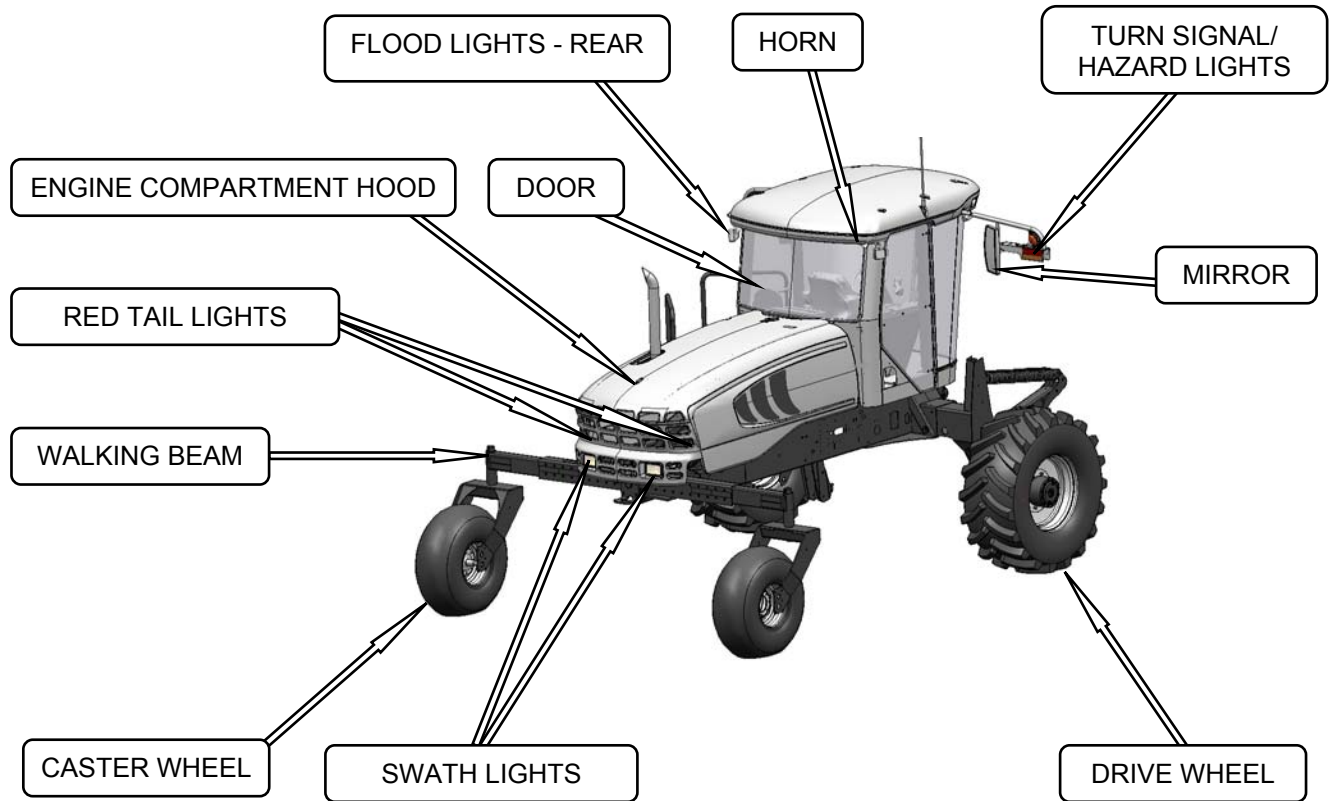
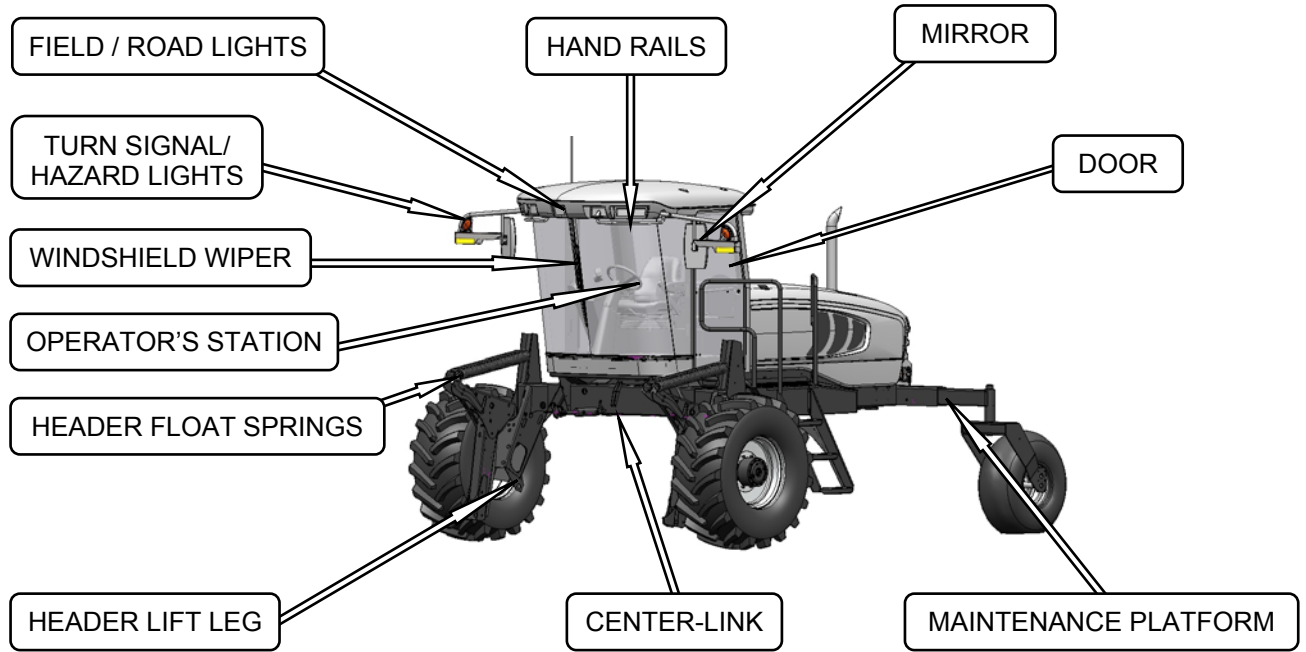

# OPERATOR'S STATION

## 5 OPERATOR'S STATION

The Operator's station is designed for operating the windrower in a cab-forward mode.

### 5.1 OPERATOR CONSOLE

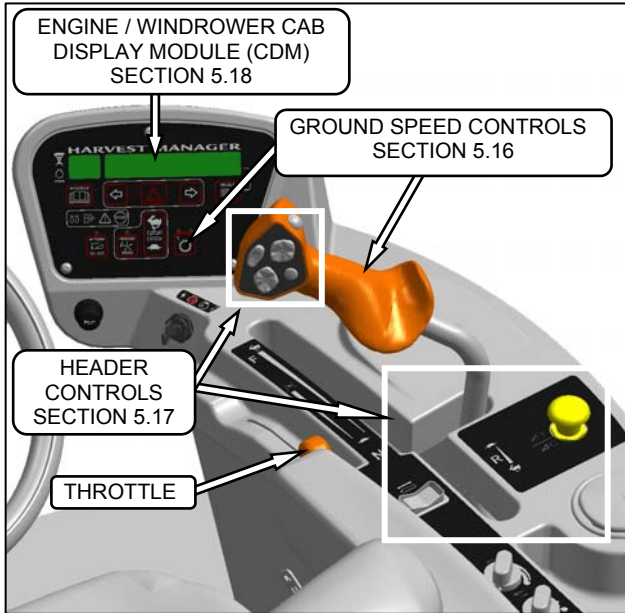

The console contains controls to operate the windrower as well as amenities for the Operator.

### 5.2 SEAT ADJUSTMENTS

The Operator's seat has several adjustments. Refer to the illustration below for the location and description of each adjustment.

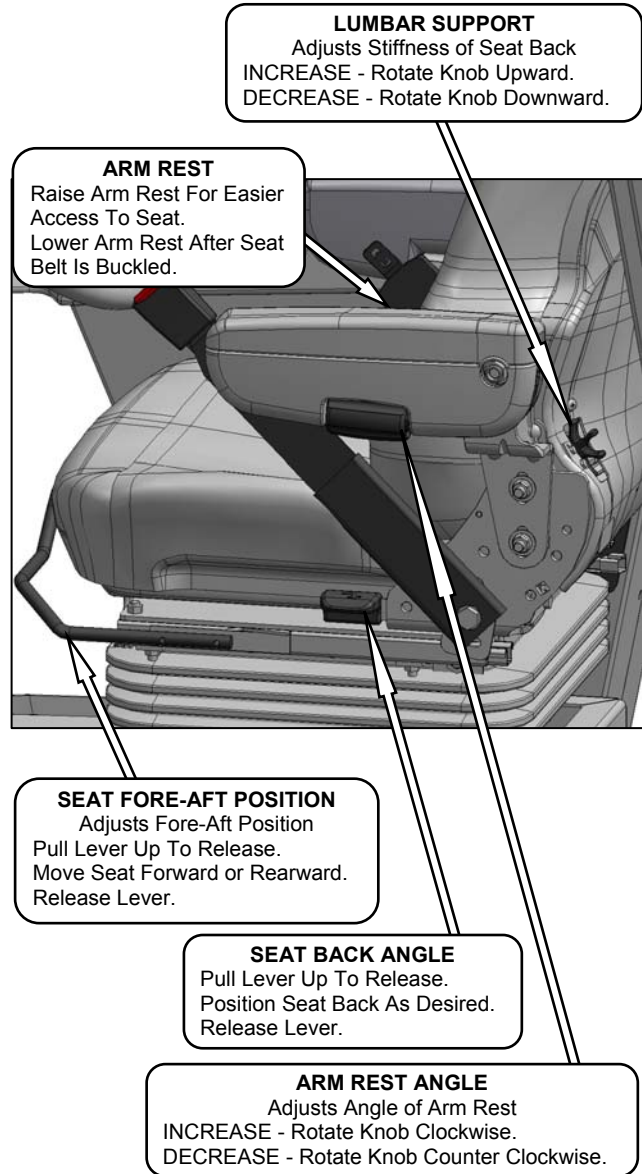

## OPERATOR'S STATION

### 5.3 TRAINING SEAT (OPTIONAL)

A wall mounted fold-up training seat complete with seat belt is provided for use as described below.

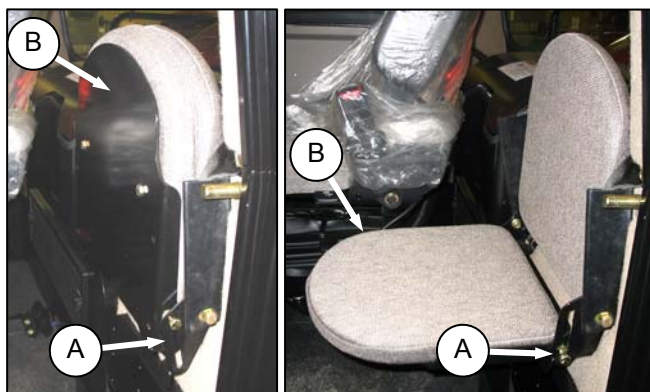

- To lower seat, lift latch (A), and lower seat (B).
- For storage, lift seat (B), and secure with latch (A).



#### WARNING

The training seat is provided for an experienced Operator of the machine when a new Operator is being trained.

The training seat is **NOT** intended as a PASSENGER SEAT, or FOR USE BY CHILDREN.

USE THE SEAT BELT whenever operating the machine or riding as a Trainer.

KEEP ALL OTHER RIDERS OFF THE MACHINE.

### 5.4 SEAT BELTS

The windrower is equipped with a seat belt on the Operator's and Trainer's seats.



#### WARNING

- Before starting engine, securely fasten your seat belt, and ensure Trainer's seat belt is fastened (if occupied). The seat belt can help ensure your safety if it is used and maintained.
- Never wear a seat belt loosely or with slack in the belt system.
- Never wear the belt in a twisted condition or pinched between the seat structural members.

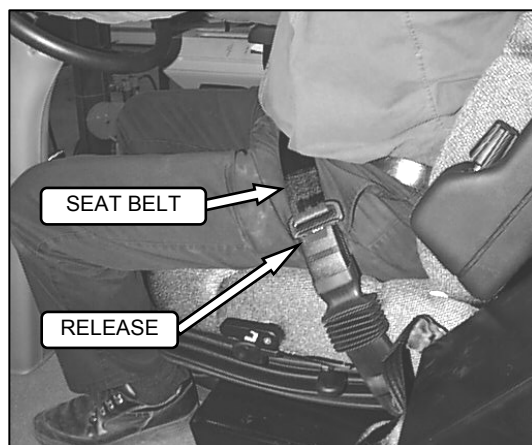

- To fasten seat belt, pull belt completely across your body. Push the metal eye into the buckle until it locks. Adjust the position of the belt as low on your body as possible.
- To release, push the red button in the end of the buckle, and separate the buckle and metal eye.

### 5.5 STEERING COLUMN ADJUSTMENT

The steering column can be adjusted to suit each particular Operator, and for easier entry to and exit from the seat.



- Hold on to steering wheel, step on lever (C), and move steering wheel up or down to desired position.
- Release lever (C) to lock steering wheel position.

# OPERATOR'S STATION

## 5.6 OPERATOR PRESENCE

The Operator Presence System is a safety feature that is designed to deactivate or alarm selected systems when the Operator is not seated at the Operator's station. These systems include:

- Header Drive.
- Transmission.
- Engine.

### 5.6.1 *Header Drive*

- Requires the Operator to be seated in the seat in order to engage the header drive.
- Power is maintained to the header drive for 5 seconds after the Operator leaves the seat, and then the header shuts down.
- If the seat switch is open for more than 5 seconds, the seat switch closes, and requires the Operator to move the HEADER DRIVE switch to OFF, and then to ON to restart the header.

### 5.6.2 *Transmission*

- If the Operator leaves the seat, and the transmission is not locked in NEUTRAL, the lower display after 2 seconds will flash "NOT IN NEUTRAL" accompanied by an alarm.

### 5.6.3 *Engine*

- The engine will not be allowed to start when the HEADER DRIVE switch is engaged.
- The engine will not be allowed to start when the transmission is not locked in NEUTRAL.
- The engine will shut down when the windrower is moving at 5 mph (8 km/h) or less, and the Operator leaves the seat.



# OPERATOR'S STATION

## 5.7 LIGHTS

The field and transport light switches are located on a panel in the cab headliner. For location of lights, refer to illustrations below:

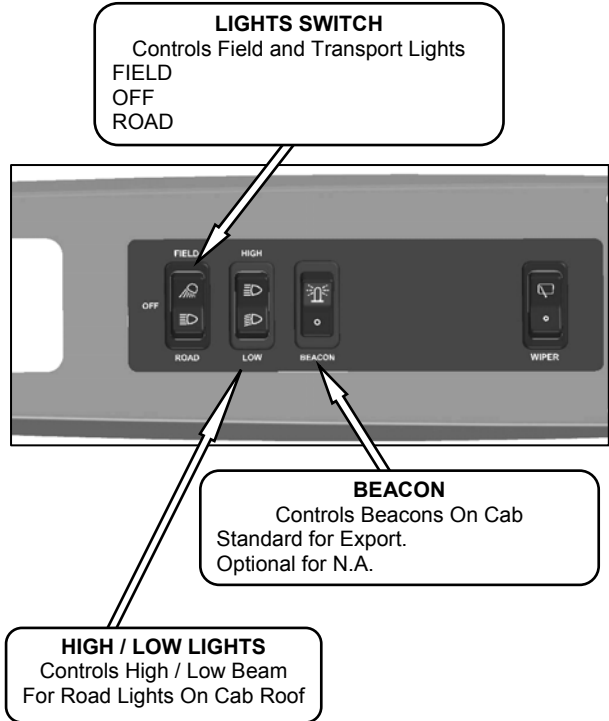

### 5.7.1 Field Lighting

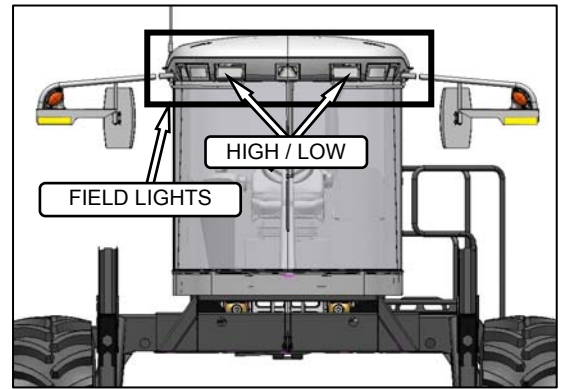

FRONT

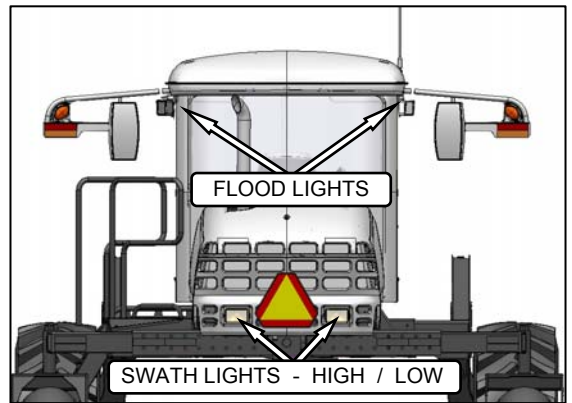

REAR

# OPERATOR'S STATION

## 5.7.2 Road Lighting

The following lights are ON/functional when the switch is in the ROAD position.

The hazard lights **must** be activated with the switch on the CDM when driving on the road.

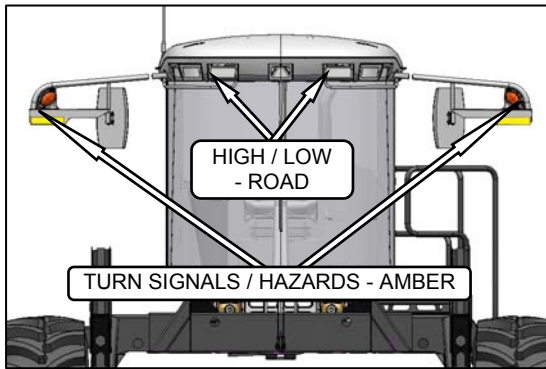
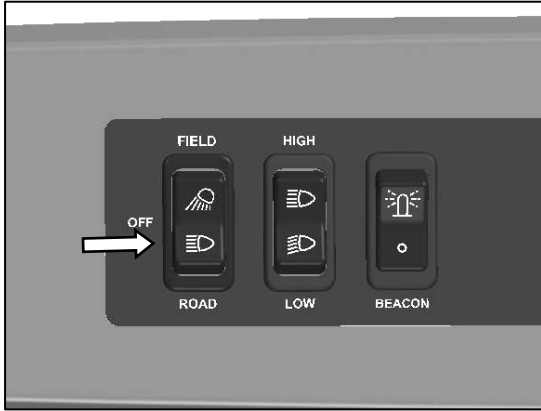

FRONT

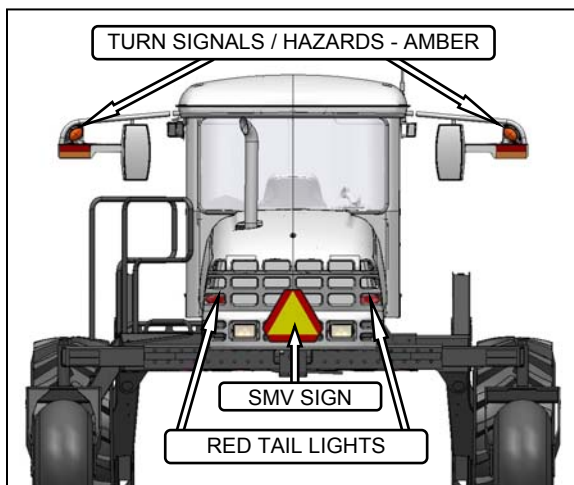
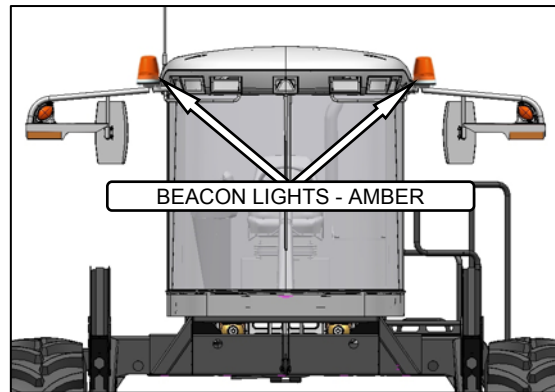

REAR

## 5.7.3 Beacon Lighting: Export (N.A. Optional)

The beacon lights are functional when the ignition and the beacon switches are ON.

The beacons **must** be used when driving on the road where required by law.

## OPERATOR'S STATION

### 5.8 WINDSHIELD WIPER

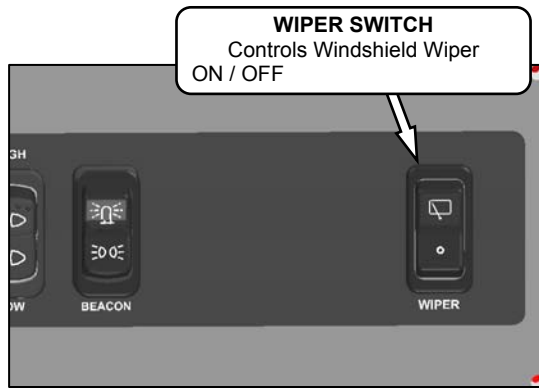

The windshield wiper control is located in the cab headliner.

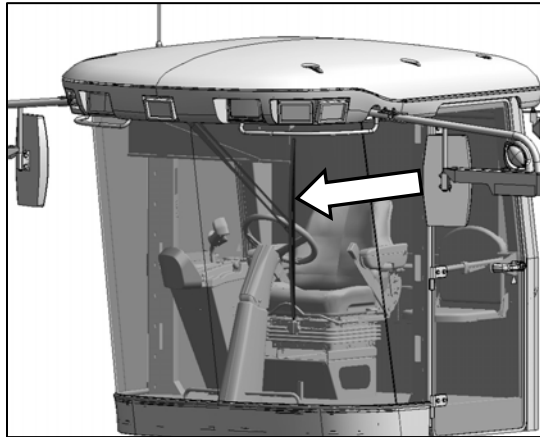

WIPER IN PARK POSITION

### 5.9 REAR VIEW MIRRORS



Two adjustable outside mounted mirrors provide rear view vision.

The mirror/light assembly is designed to fold backwards if accidentally struck either during normal operation, or by another machine. A detent-type lock keeps it in place.

# OPERATOR'S STATION

## 5.10 CAB TEMPERATURE

The cab environment is controlled by a climate-control system that provides clean air-conditioned or heated air for the Operator.

The heater/evaporator/blower assembly is located under the cab floorboard, and is accessible from beneath the windrower.

### 5.10.1 Controls

Refer to the following illustrations for an explanation of the controls and operating procedures.

#### IMPORTANT

To distribute the oil throughout the system, perform the following steps whenever the machine is first started after storage for more than one week:

- a. Ensure heater shut-off valve at engine is open. See 5.10.3 *Heater Shut-Off Valve*.

**TEMPERATURE CONTROL**  
Controls Cab Temperature  
INCREASE - Clockwise  
DECREASE - Counter Clockwise

**BLOWER SWITCH**  
Controls Blower Speed  
OFF / LOW / MEDIUM / HIGH



**AIR CONDITIONING SWITCH**  
Controls A/C System  
OFF - A/C Does Not Operate.  
ON - A/C Operates With Blower Switch ON.

- b. Turn blower switch to the first position, turn temperature control switch to maximum heating, and A/C control to OFF.
- c. Start engine, and operate at low idle until engine is warm.
- d. Click A/C switch from OFF to ON for one second, then back to OFF for 5 to 10 seconds. Repeat this step ten times.

### 5.10.2 Air Distribution

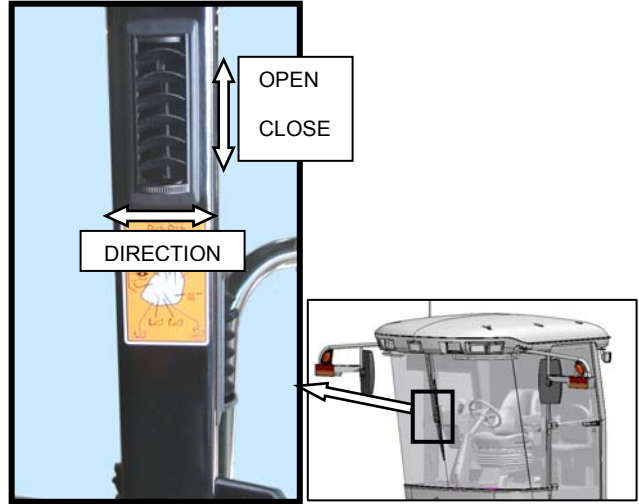

Cab air distribution is controlled through adjustable air vents located in the cab posts as shown above.

The vents provide window and Operator ventilation.

### 5.10.3 Heater Shut-Off Valve

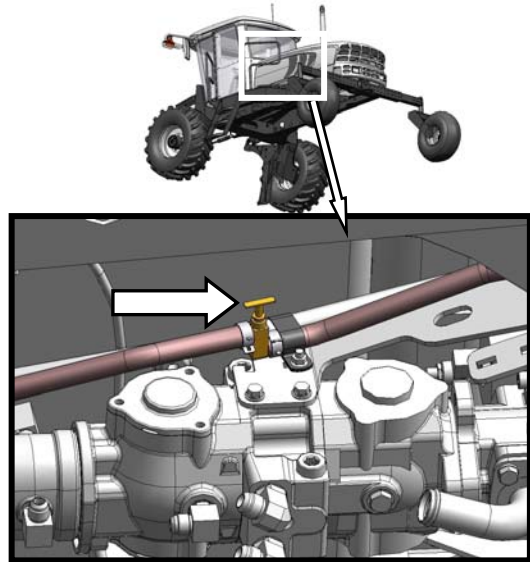

A shut-off valve at the engine allows the cab heater to be isolated from the engine coolant.

The valve must be open to provide heat to the cab, but for maximum cooling, the valve can be closed.

## OPERATOR'S STATION

### 5.10.4 A/C Compressor Protection

The compressor is protected from excessively low and high pressures by two switches that shut down the compressor to prevent damage to the system.

- The LOW pressure switch opens when the pressure falls to 2 - 8 psi (14 - 55 kPa), and shuts down the compressor. When the pressure rises to 15 - 25 psi (103 - 172 kPa), the switch closes, and allows the compressor to run.
- The HIGH pressure switch opens and stops the compressor when the pressure rises to 315 - 335 psi (2172 - 2310 kPa). When the pressure falls to 220 - 280 psi (1517 - 1930 kPa), the switch closes and allows the compressor to run.

If the air conditioning system is shut down by either switch, locate the source of the problem, and correct it before operating the system.

### 5.11 INTERIOR LIGHTS

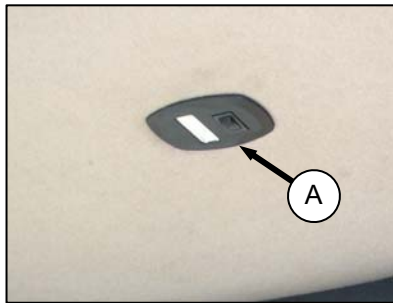

Two interior lights are installed in the cab headliner. A low intensity LED light (A) is located directly overhead to provide ambient lighting if desired, and functions only when the ROAD/FIELD light switch is ON. An ON-OFF switch is located on the light.

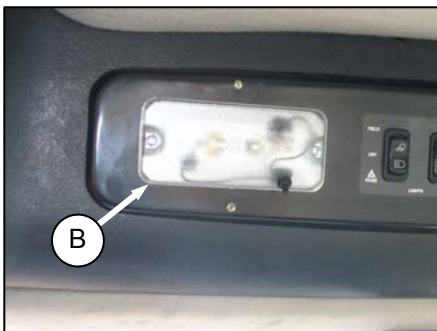

The other interior light (B) is located on the headliner switch panel, and the push-ON, push-OFF button is located on the light.

### 5.12 OPERATOR AMENITIES

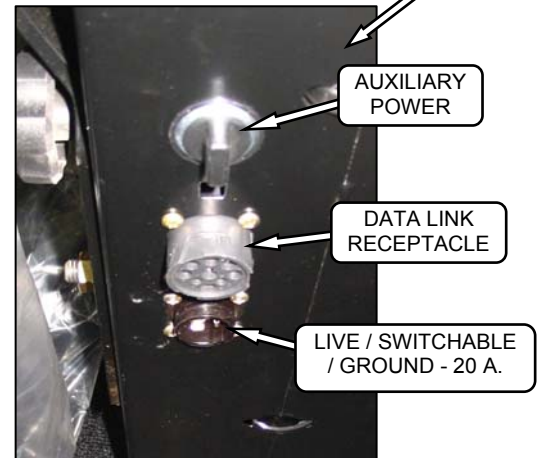
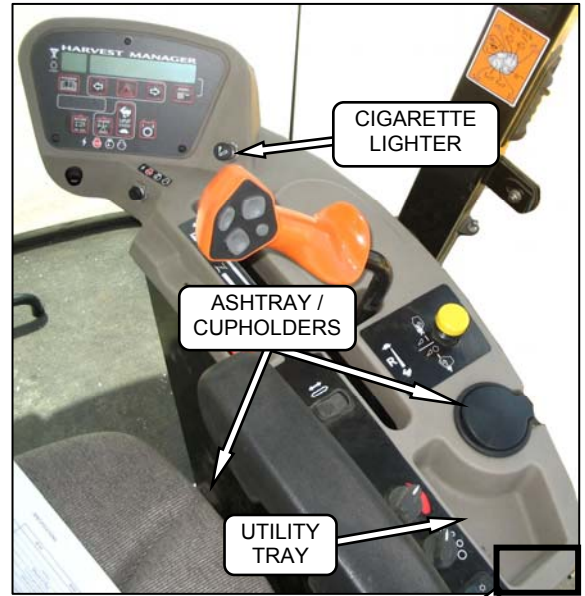

## OPERATOR'S STATION

### 5.13 RADIOS

#### 5.13.1 AM/FM Radio

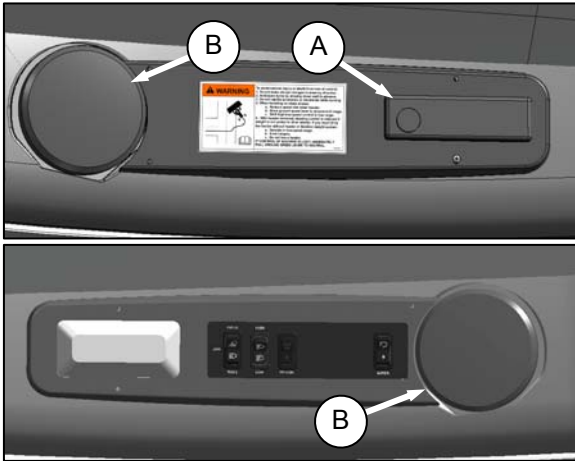

A radio (A) is available as optional equipment from your Dealer, and a space is provided in the cab headliner to accommodate the installation.

Two pre-wired speakers (B) have been factory-installed in the headliner. Refer to Form 169558 M105 Self-Propelled Windrower Unloading and Assembly Instruction for radio installation procedures. Operating instructions are supplied with the radio.

#### 5.13.2 Antenna Mounting

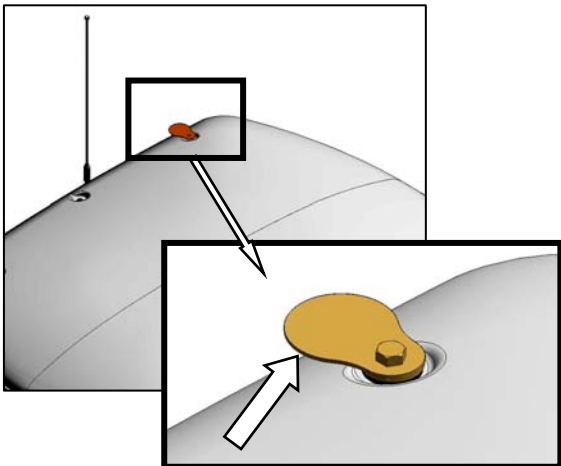

A roof mounted antenna base for installing a magnetic antenna is available as an option from your Dealer.

Order part #160288, or see next illustration for part dimensions for a homemade version. It accommodates most CB, 2-way radio and satellite radio antennas. Refer to Form 169558 M105 Self-Propelled Windrower Unloading and Assembly Instruction for installation procedures.

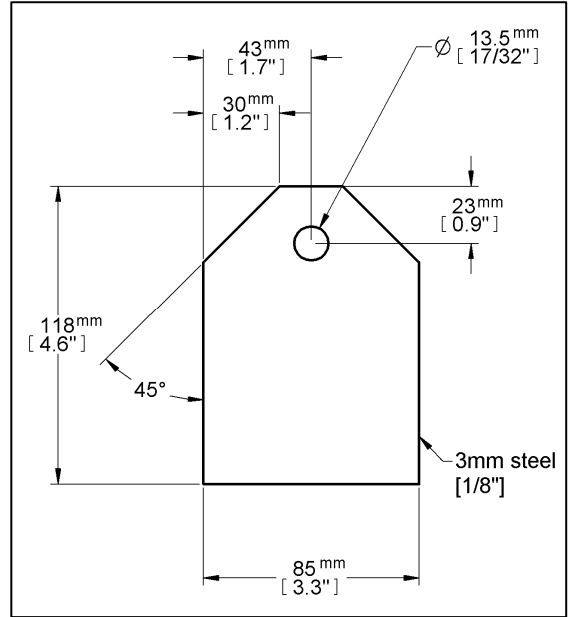

11 GA. OR 3.0 mm CQHRS

#### IMPORTANT

Antenna base can only be installed on the LH and RH rear cab roof bolts.

### 5.14 HORN



The horn is activated by pushing the button located beside the ignition key.

Sound the horn three times prior to starting the engine.

# OPERATOR'S STATION

## 5.15 ENGINE CONTROLS

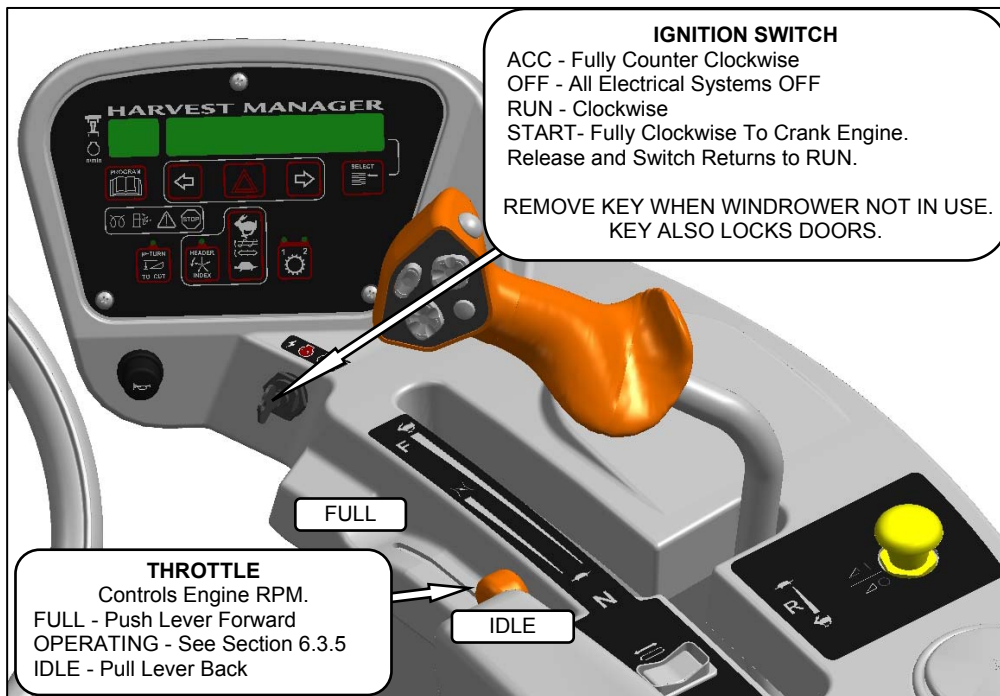

## 5.16 WINDROWER CONTROLS

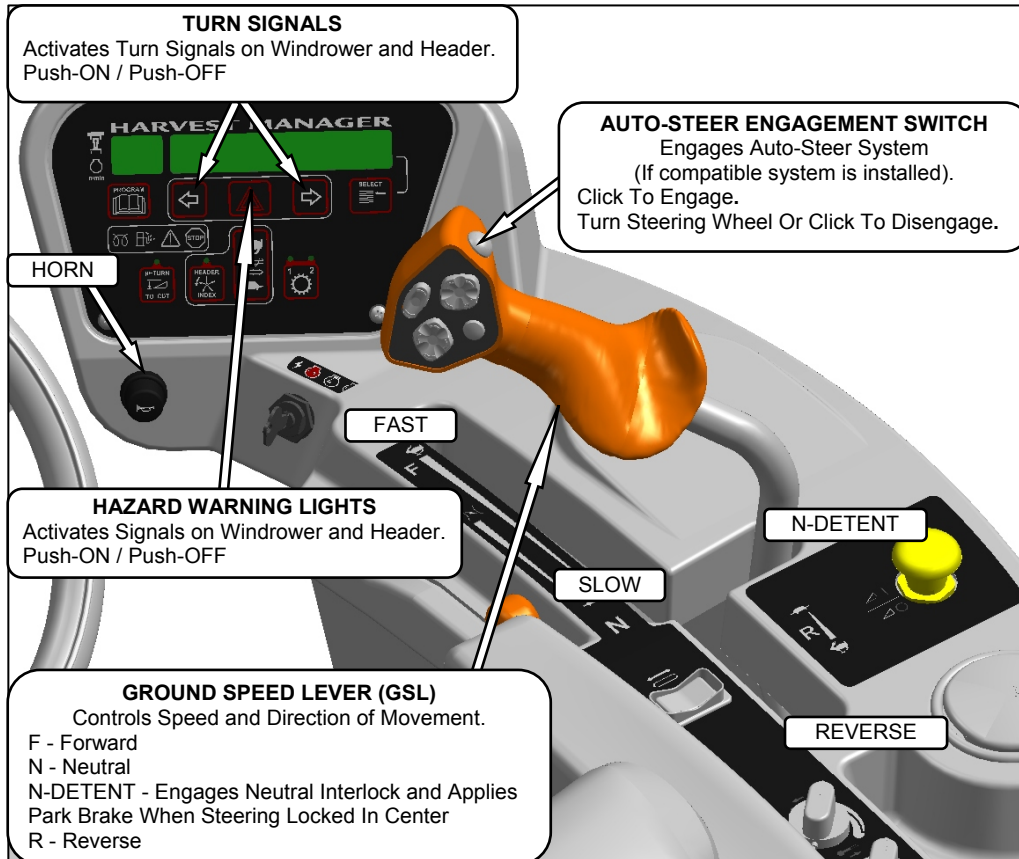

# OPERATOR'S STATION

## 5.17 HEADER CONTROLS

All header controls are conveniently located on the Operator's console, and on the GSL handle.

### NOTE

Some controls are optional equipment, and may not be present in your unit. Some controls may be installed, but will be non-functional for certain headers.

### 5.17.1 Header Drive Switch



Engages and disengages header drive.

### IMPORTANT

Always move throttle lever back to idle before engaging header drive.

Do not engage header with engine at full RPM.

### 5.17.2 Deck Shift - Draper Header Option

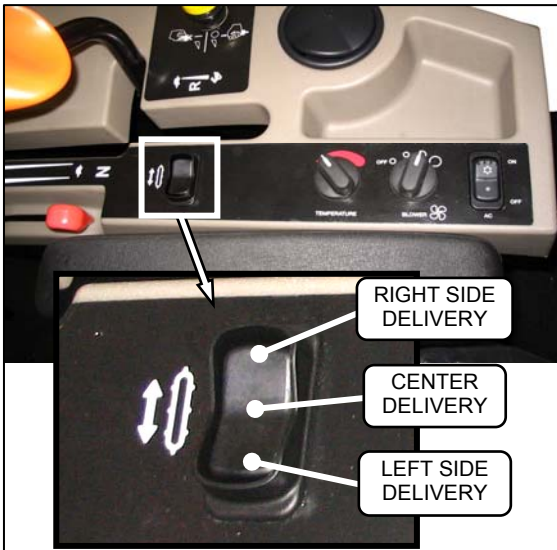

Controls deck shifting for double windrowing options with a draper header.

### 5.17.3 GSL Header Switches

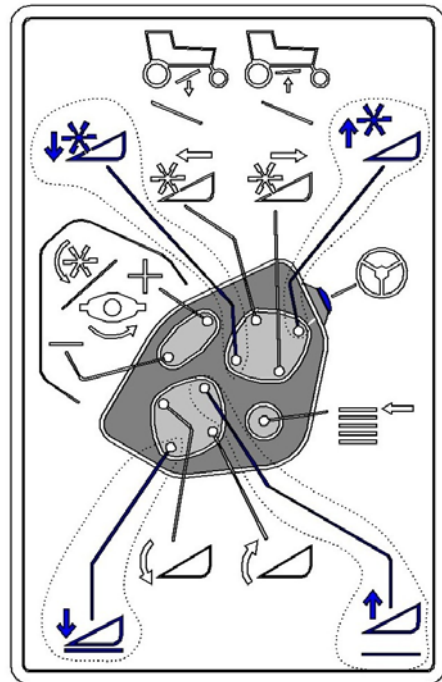
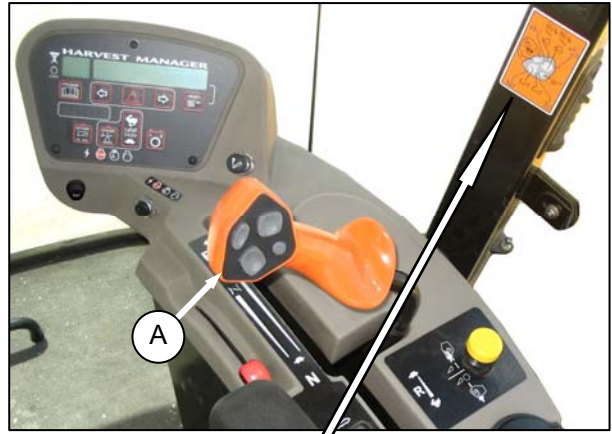

The GSL (A) contains switches for the following header functions that are most often adjusted while in operation to suit changing crop conditions.

All are momentary type switches.

A decal that identifies the switch functions is located on the cab post above the Operator's console.

- Display Selector.
- Reel Position.
- Header Position.
- Reel Speed.



## OPERATOR'S STATION

### 5.17.3.1 Display Selector Switch



Selects and displays the settings in the CDM display top line read-out for each of the header controls.

- Press the switch to scroll through settings.

### 5.17.3.2 Reel Position Switches

#### NOTE

*Reel position switches work only on draper headers.*

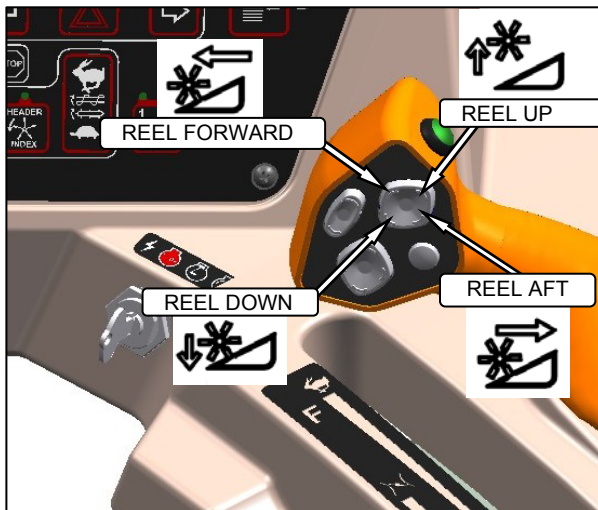

- Press and hold the switch at location shown to move reel.
- Release switch at desired position.

### 5.17.3.3 Header Position Switches

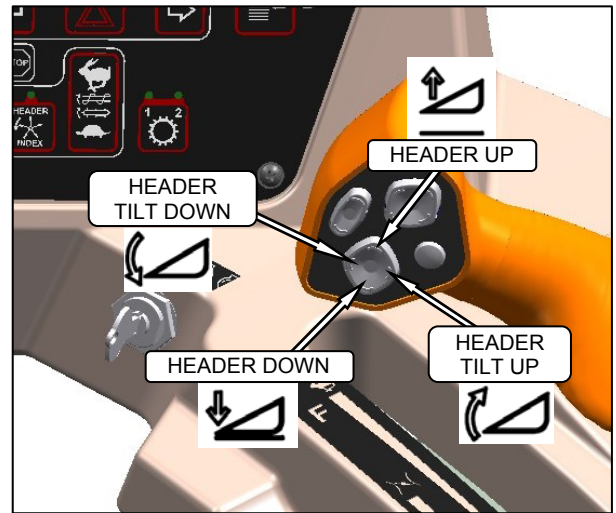

- Press and hold the switch at location shown to move header.
- Release the switch at desired position.

### 5.17.3.4 Reel Speed Switches

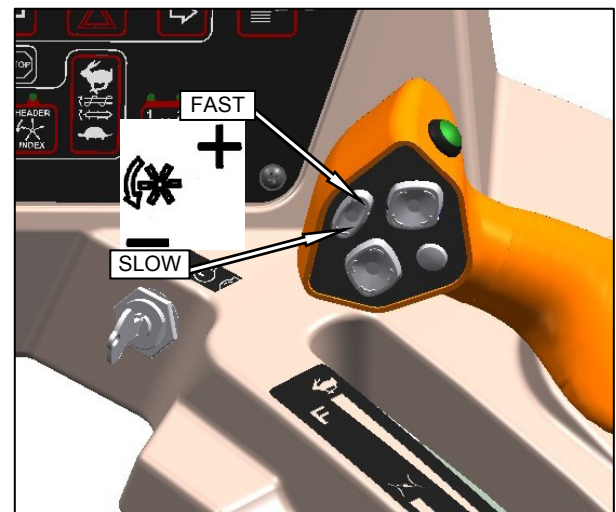

- Press and hold the switch at location shown to change reel speed.
- Release the switch at desired speed.

#### NOTE

*Auger speed adjusts proportionately when reel speed is changed.*

*For further details, see Section 6.5.7 for D-Series Headers, or 6.6.3 for A-Series Headers.*

# OPERATOR'S STATION

## 5.18 CAB DISPLAY MODULE (CDM)

### 5.18.1 Engine and Windrower Functions

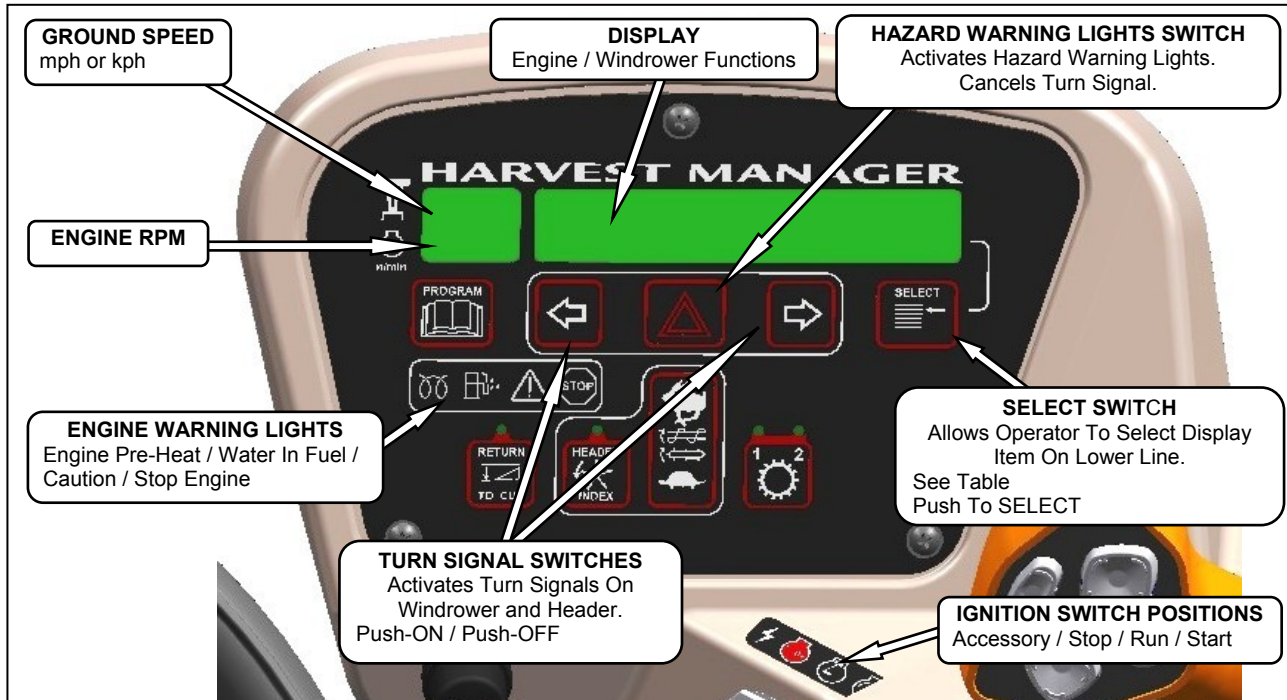

### 5.18.2 Header Functions

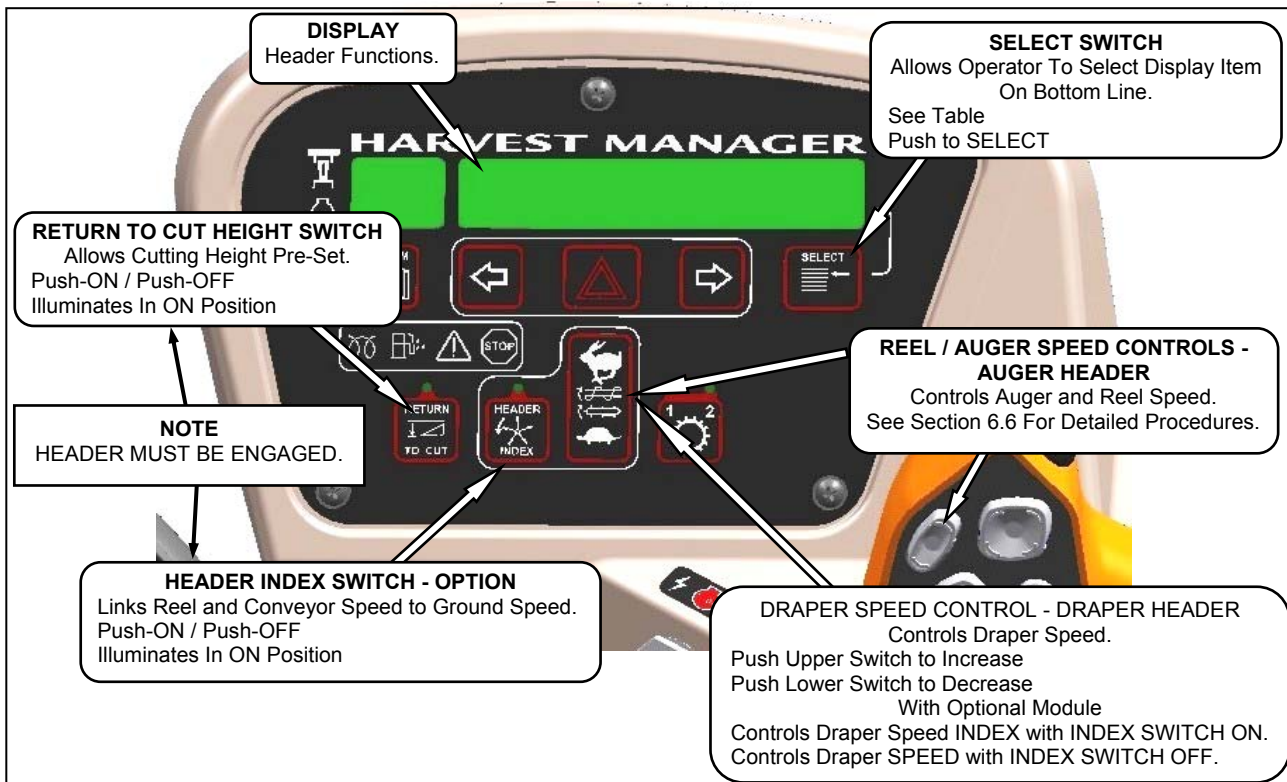

## OPERATOR'S STATION

### 5.18.3 Operating Screens

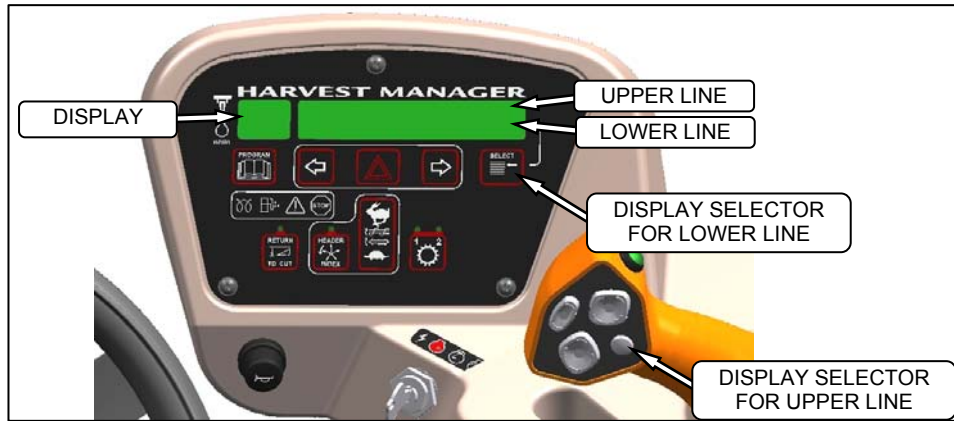

The M105 windrower Cab Display Module (CDM) and the Windrower Control Module (WCM) provide information on several functions for the engine, header, and windrower. The information displayed in various operating modes is described in the following sections:

### IGNITION ON / ENGINE NOT RUNNING

DISPLAY (Upper Line) (2 - 3 Seconds)	DESCRIPTION
<b>HEADER DISENGAGED</b>	Indicates HEADER DRIVE Switch Is OFF.
<b>IN PARK</b>	Indicates GSL In N-DETENT.

### ENGINE RUNNING / HEADER DISENGAGED

(Scroll Through Display with CDM Switch or GSL Switch)

DISPLAY (Lower or Upper Line)	DESCRIPTION
<b>#####.# ENGINE HRS</b>	Total Engine Operating Time.
<b>#####.# HEADER HRS</b>	Total Header Operating Time.
<b>###.# SUB ACRES</b> <b>###.# SUB HECTARES</b> (If Metric)	Area Cut Since Last Reset. To Reset, Display SUB ACRES On Lower Line And Hold Down Program Switch Until Display Resets (5 - 7 Seconds).
<b>##### TOTAL ACRES</b> <b>##### TOTAL HECT</b> (If Metric)	Total Area Cut By Machine.
<b>##.# HEADER HEIGHT</b>	(00.0 - 10.0) Distance Between Cutterbar and Ground.
<b>##.# HEADER ANGLE</b>	(00.0 - 10.0) Header Angle Relative to Ground. Optional.*
<b>FUEL LEVEL</b>  ■■■■ ■■■■	Level of Fuel In Tank.
<b>ENGINE TEMP ### ° F</b> <b>ENGINE TEMP ### ° C</b> (If Metric)	Engine Coolant Temperature.
<b>##.# VOLTS</b>	Engine Electrical System Operating Voltage.
<b>SCROLL</b> (Lower Line)	
<b>ROAD GEAR</b> (Upper Line)	Ground Speed Range Switch In High Range.

\*Optional: Available with Expansion Module Installation - MacDon Part No. B4666.

## OPERATOR'S STATION

### ENGINE RUNNING / HEADER ENGAGED AUGER HEADER

(Scroll Through Display with CDM Switch or GSL Switch)

DISPLAY (Lower or Upper Line)	DESCRIPTION
<b>##### ENGINE HRS</b>	Total Engine Operating Time.
<b>##### HEADER HRS</b>	Total Header Operating Time.
<b>### ACRES/HOUR</b> <b>### HECTARES/HOUR</b> (If Metric)	Cutting Rate In Acres (Hectares) / Hour.
<b>### SUB ACRES</b> <b>### SUB HECTARES</b> (If Metric)	Area Cut Since Last Reset.
<b>##### TOTAL ACRES</b> <b>##### TOTAL HECT</b> (If Metric)	Total Area Cut.
<b>### REEL RPM</b> <b>### RPM SENSOR</b> (Flashing)	Reel Rotational Speed. Optional.* Sensor Disabled
<b>### AUGER SPEED</b>	Auger Rotational Speed (4.7 - 9.9).
<b>#### KNIFE SPEED</b> <b>#### SPEED SENSOR</b> (Flashing)	Knife Speed In Strokes Per Minute. Optional.* Sensor Disabled.
<b>### HEADER HEIGHT</b> <b>### HEIGHT SENSOR</b> (Flashing)	(00.0 - 10.0) Distance Between Cutterbar and Ground. Sensor Disabled.
<b>### HEADER ANGLE</b> <b>### ANGLE SENSOR</b> (Flashing)	(00.0 - 10.0) Header Angle Relative To Ground. Opt.* Sensor Disabled.
<b>FUEL LEVEL  ■■■■ ■■■■ </b>	Level of Fuel In Tank.
<b>ENGINE TEMP ### ° F</b> <b>ENGINE TEMP ### ° C</b> (If Metric)	Engine Coolant Temperature.
<b>### VOLTS</b>	Engine Electrical System Operating Voltage.
<b>SCROLL</b> <i>SUB-MENU (Lower Line Only)</i> <b>#### KNIFE SPEED</b> <b>### AUGER SPEED</b> <b>### REEL RPM</b> <b>### HEADER HEIGHT</b> <b>FUEL LEVEL  ■■■■ ■■■■ </b> <b>ENGINE TEMP ### ° F</b> <b>ENGINE TEMP ### ° C</b> (If Metric)	<i>Displays Sub-Menu After 2 - 3 Seconds. Press SELECT to cancel. Scroll Through Sub-Menu Display with CDM Switch.</i> Optional.*  Optional.*

\* Optional: Available with Expansion Module Installation - MacDon Part No. B4666.

**OPERATOR'S STATION**  
**ENGINE RUNNING / HEADER ENGAGED**  
**DRAPER HEADER / INDEX SWITCH OFF**

(Scroll Through Display with CDM Switch or GSL Switch)

DISPLAY (Lower or Upper Line)	DESCRIPTION
<b>#####.# ENGINE HRS</b>	Total Engine Operating Time.
<b>#####.# HEADER HRS</b>	Total Header Operating Time.
<b>##.# ACRES/HOUR</b> <b>##.# HECTARES/HOUR</b> (If Metric)	Cutting Rate In Acres (Hectares) / Hour.
<b>###.# SUB ACRES</b> <b>###.# SUB HECTARES</b> (If Metric)	Area Cut Since Last Reset.
<b>##### TOTAL ACRES</b> <b>##### TOTAL HECT</b> (If Metric)	Total Area Cut By Machine.
<b>##.## REEL MPH or RPM</b> <b>##.## REEL KPH</b> (If Metric) <b>##.## REEL SENSOR</b> (Flashing)	Reel Peripheral Speed in Miles Per Hour or RPM. Opt.* Sensor Disabled.
<b>##.# DRAPER SPEED</b>	Draper Speed (0.0 - 10.0).
<b>#### KNIFE SPEED</b> <b>#### SPEED SENSOR</b> (Flashing)	Knife Speed In Strokes Per Minute. Optional.* Sensor Disabled.
<b>##.# HEADER HEIGHT</b> <b>##.# HEIGHT SENSOR</b> (Flashing)	(00.0 - 10.0) Distance Between Cutterbar and Ground. Sensor Disabled.
<b>##.# HEADER ANGLE</b> <b>##.# ANGLE SENSOR</b> (Flashing)	(00.0 - 10.0) Header Angle Relative To Ground. Opt.* Sensor Disabled.
<b>FUEL LEVEL  ■■■■ ■■■■ </b>	Level of Fuel In Tank.
<b>ENGINE TEMP ### ° F</b> <b>ENGINE TEMP ### ° C</b> (If Metric)	Engine Coolant Temperature.
<b>##.# VOLTS</b>	Engine Electrical System Operating Voltage.
<b>SCROLL</b> <i>SUB-MENU (Lower Line Only)</i> <b>#### KNIFE SPEED</b> <b>##.## REEL RPM</b> <b>##.# DRAPER SPEED</b> <b>FUEL LEVEL  ■■■■ ■■■■ </b> <b>ENGINE TEMP ### ° F</b> <b>ENGINE TEMP ### ° C</b> (If Metric) <b>##.# HEADER HEIGHT</b>	<i>Displays Sub-Menu After 2 - 3 Seconds. Press SELECT to cancel. Scroll Through Sub-Menu Display with CDM Switch.</i> Optional.*
<b>KNIFE SPD OVERLOAD</b> (Lower Line)	Knife Speed Is Less Than Programmed Set-Point.

\* Optional: Available with Expansion Module Installation - MacDon Part No. B4666.

## OPERATOR'S STATION



### ENGINE RUNNING / HEADER ENGAGED DRAPER HEADER / INDEX SWITCH ON

(Scroll Through Display with CDM Switch or GSL Switch)

DISPLAY (Lower or Upper Line)	DESCRIPTION
<b>##### ENGINE HRS</b>	Total Engine Operating Time.
<b>##### HEADER HRS</b>	Total Header Operating Time.
<b>### ACRES/HOUR</b> <b>### HECTARES/HOUR</b> (If Metric)	Actual Cutting Rate In Acres (Hectares) / Hour.
<b>### SUB ACRES</b> <b>### SUB HECTARES</b> (If Metric)	Area Cut Since Last Reset.
<b>##### TOTAL ACRES</b> <b>##### TOTAL HECT</b> (If Metric)	Total Area Cut By Machine.
<b>### ## REEL IND</b> <b>### REEL SENSOR</b>	Reel Peripheral Speed Along With Ground Speed In MPH or KPH. Optional.* Sensor Disabled.
<b>### ## DRAP INDX</b>	Draper Speed Along With Ground Speed In MPH or KPH.
<b>#### KNIFE SPEED</b> <b>#### SPEED SENSOR</b> (Flashing)	Knife Speed In Strokes Per Minute. Optional.* Sensor Disabled.
<b>### HEADER HEIGHT</b> <b>### HEIGHT SENSOR</b> (Flashing)	(00.0 - 10.0) Distance Between Cutterbar and Ground. Sensor Disabled.
<b>### HEADER ANGLE</b> <b>### ANGLE SENSOR</b> (Flashing)	(00.0 - 10.0) Header Angle Relative To Ground. Opt.* Sensor Disabled.
<b>FUEL LEVEL  ■■■■ ■■■■ </b>	Level of Fuel In Tank.
<b>ENGINE TEMP ### ° F</b> <b>ENGINE TEMP ### ° C</b> (If Metric)	Engine Coolant Temperature.
<b>### VOLTS</b>	Engine Electrical System Operating Voltage.
<b>SCROLL</b> SUB-MENU (Lower Line Only) <b>#### KNIFE SPEED</b> <b>### HEADER HEIGHT</b> <b>### ## REEL INDRPM</b> <b>### ## DRAP INDX</b> <b>FUEL LEVEL  ■■■■ ■■■■ </b> <b>ENGINE TEMP ### ° F</b> <b>ENGINE TEMP ### ° C</b> (If Metric)	<i>Displays Sub-Menu After 2 - 3 Seconds. Press SELECT to cancel. Scroll Through Sub-Menu Display with CDM Switch.</i>  Optional.*
<b>### ## REEL MIN RPM</b> (Lower Line)	Reel Speed Less Than Set-Point. Optional.*
<b>MINIMUM</b> (Lower Line)	Optional.*

\* Optional: Available with Expansion Module Installation - MacDon Part No. B4666.

**OPERATOR'S STATION**  
**MISCELLANEOUS OPERATIONAL INFORMATION**

DISPLAY (Upper Line)	DESCRIPTION
< LEFT TURN ■	Indicates Left Turn When  Is Pressed On CDM.
■ RIGHT TURN >	Indicates Left Turn When  Is Pressed On CDM.
■ HAZARD ■	Indicates Hazard Warning Lights Are ON When  Is Pressed On CDM.
ROAD GEAR	With High Range Selected On Console Switch.
HEADER ENGAGED	Header Drive Engaged.

## OPERATOR'S STATION

### 5.18.4 Cab Display Module (CDM) Warnings/Alarms

The CDM displays warnings and sounds alarms to notify the Operator of abnormal windrower status at startup when the ignition is turned ON, and at engine operating speeds above 500 rpm.

#### 5.18.4.1 Engine Warning Lights

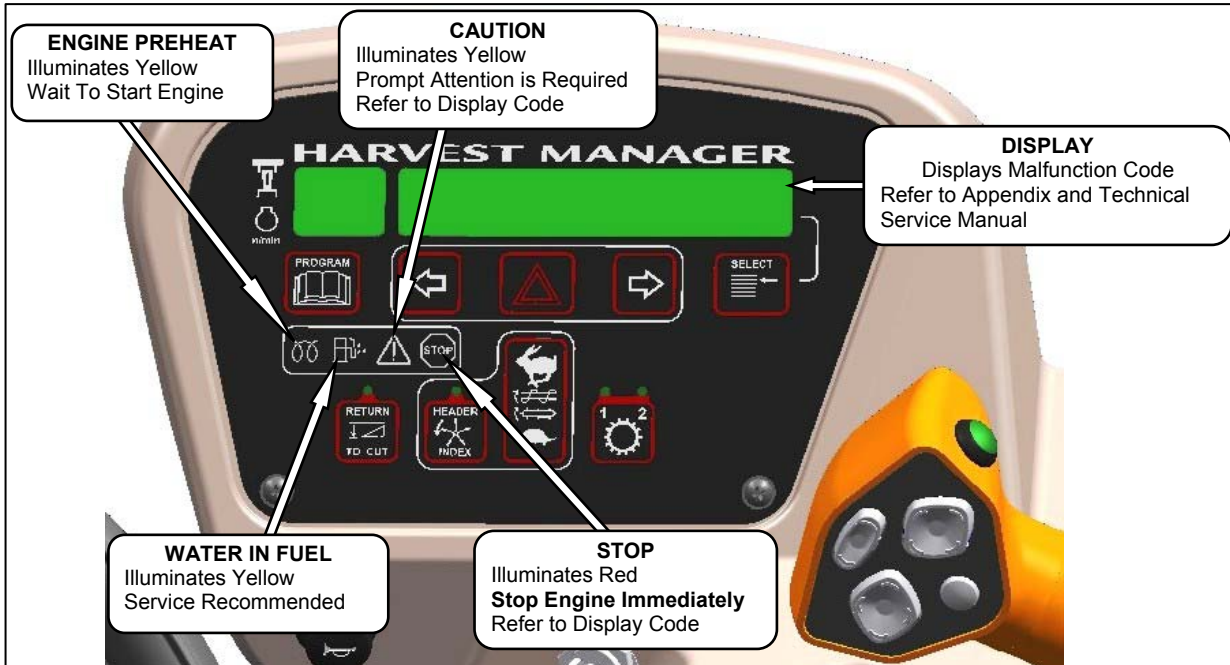



## OPERATOR'S STATION

### 5.18.4.2 Display Warnings



### DISPLAY WARNINGS AND ALARMS - ENGINE/TRANSMISSION

DISPLAY	FLASHING	ALARM TONE	DESCRIPTION
ENGINE OIL PRESSURE	✓	Continuous Loud Tone Until Oil Pressure Is Regained.	Low Engine Oil Pressure. Accompanied By Warning Lights.
ENGINE TEMPERATURE	✓	Ongoing Intermittent Moderate Tone Until Temperature Is Below 215°F (102°C).	Engine Temperature Over 230°F (110°C). Accompanied By Warning Lights.
### LOW VOLTS	✓	Short Beep Every 2 seconds. Flashes every second.	Voltage Below 11.5.
### HIGH VOLTS	✓	Short Beep Every 2 seconds. Flashes every second.	Voltage Above 15.4.
IN PARK	✓	One Short Beep	Steering Wheel Centered, And Brakes Are Engaged.
PLACE GSL INTO "N"		Beeps At 2 Per Second Until Corrected.	Interlock Switch Not Closed With Key ON / Engine OFF.
TRANS OIL PRESS	✓	Continuous Loud Tone Until Oil Pressure Is Regained.	Low Transmission Charge Oil Pressure.
TRANS OIL TEMP	✓	Ongoing Intermittent Moderate Tone Until Temperature Is Below Acceptable Level.	Transmission Oil Temperature Above 221°F (105°C).

*(continued next page)*

## OPERATOR'S STATION

### DISPLAY WARNINGS AND ALARMS - WINDROWER

DISPLAY	FLASHING	ALARM TONE	DESCRIPTION
<b>CENTER STEERING</b>		Beeps At 2 Per Second	Interlock Switch Not Closed With Key ON / Engine OFF.
<b>DISENGAGE HEADER</b>	✓	None	Header Switch Is ON When Ignition Switch Turned ON.
<b>HEADER DISENGAGED</b>		None	Normal
<b>KNIFE SPD OVERLOAD</b>	✓	Ongoing Intermittent Moderate Tone Until Condition Is Corrected.	Machine Overload. Knife Speed Drops Below Programmed Value.
<b>LOW HYDRAULIC OIL</b>	✓	Continuous Loud Tone For 5 Seconds. If Condition Not Rectified, Single Loud Tone Every 5 Minutes	Low Hydraulic Oil Level. Header Shuts Down Automatically If Engaged.  Header Drive Switch Must Be Moved To OFF And Then To ON To Restart The Header.
<b>NO OPERATOR</b>		Continuous Tone.	Operator Not Detected In Seat With Header Engaged Or Out Of N-Detent. Engine Shutdown After 5 Seconds.
<b>NOT IN PARK</b>	✓	Short Beep With Each Flash	Interlock Switch Not Closed With Key ON / Engine OFF.

## OPERATOR'S STATION

### 5.18.5 Cab Display Module (CDM) Programming

The monitoring system requires programming for each header, and the **header must be attached to the windrower**. Programming the system may be accomplished with or without the engine running.

If the engine is running, the transmission must be in NEUTRAL. If the engine is not running, the ignition must be ON.





Exit Programming Mode at any time by pressing the PROGRAM switch, or by turning the ignition OFF.

The system only needs to be programmed once for each header. The Operator may make changes later on to a particular setting to suit windrowing conditions or modifications to the machine. Most functions have been pre-programmed at the factory, but can be changed by the Operator if required.

Proceed as follows to program the CDM:

#### IMPORTANT

Header must be attached to the windrower. See Sections 6.5 and 6.6 (depending on your header).

- Turn ignition key to RUN, or start the engine. Refer to section 6.3.4 *Engine Operation*.
- Press PROGRAM and SELECT on CDM to enter Programming Mode.
- Press SELECT. TRACTOR SETUP? is displayed on upper line.
- Press  and then SELECT. HEADER TYPE? is displayed. DRAPER is flashing on lower line.
- Press  or  to change value on lower line.
- Press SELECT. TILT CYL INSTALLED? is displayed.
- Press  or  to change value on lower line.
- Press SELECT to advance to the next L1 item, and press arrow keys to change values.
- Press PROGRAM to exit Programming Mode when finished entering desired values.

Refer to Detailed Programming Instructions on following pages.

#### NOTE

Contact your MacDon Dealer for information regarding software updates to the electronic modules.

Your Dealer will have the necessary interface tools and access to the latest software upgrades.

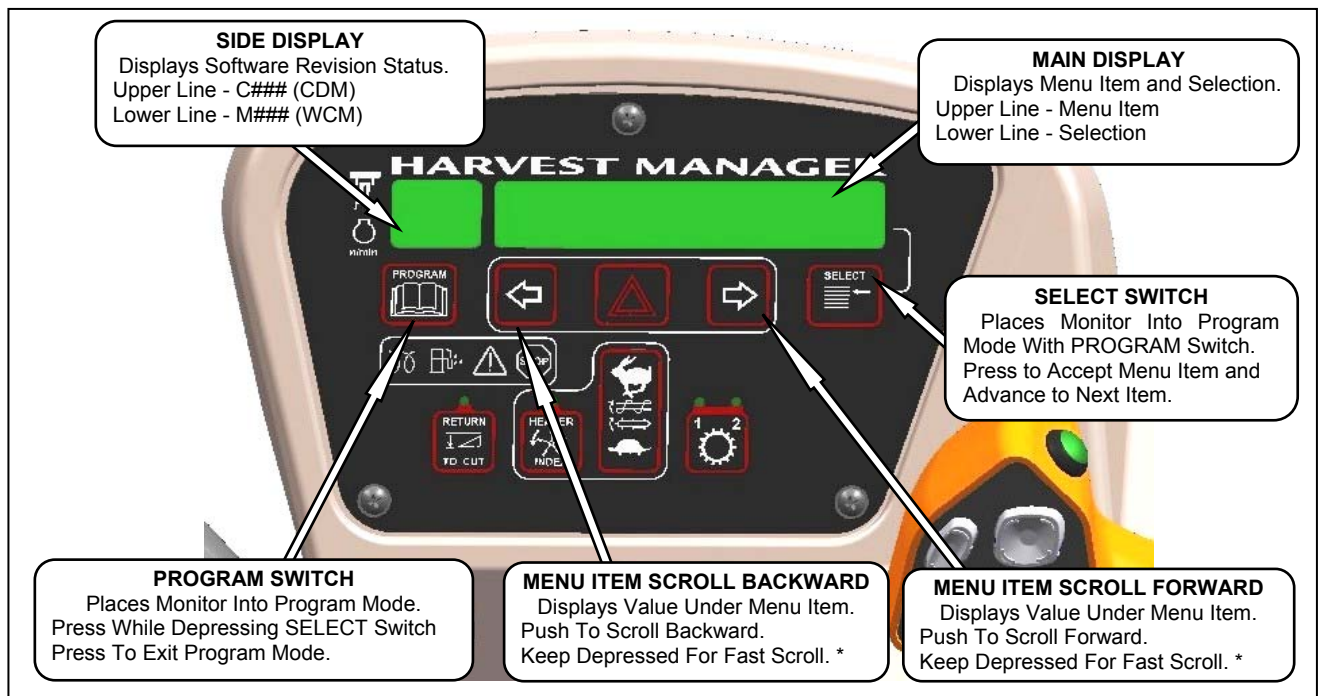

\* Fast scroll applies only when changing OVERLOAD PRESSURE, and TIRE SIZE.

# OPERATOR'S STATION

## DETAILED PROGRAMMING INSTRUCTIONS

(Key On / Engine Running or Not / Header Disengaged).  
 (Press **PROGRAM** and **SELECT** on CDM to enter Programming Mode).

**NOTE: ENGINE MUST BE RUNNING TO CALIBRATE SENSORS.**

Programming Menu Flow Chart

	L1 <b>C x x x x</b>    <b>TRACTOR SETUP?</b>	If "NO" then jump to:
	L2 <b>M x x x x</b>    <b>NO / YES</b>	<b>CAB DISPLAY SETUP?</b>
<div style="border: 1px solid black; padding: 5px; margin-bottom: 10px;">                 L1 <b>C x x x x</b>    <b>SELECT HEADER TYPE?</b>                  L2 <b>M x x x x</b>    <b>DRAPER</b> </div> L1 <b>C x x x x</b>    <b>SELECT HEADER TYPE?</b> L2 <b>M x x x x</b>    <b>A3'0 AUGER</b> L1 <b>C x x x x</b>    <b>SELECT HEADER TYPE?</b> L2 <b>M x x x x</b>    <b>A4'0 AUGER</b> L1 <b>C x x x x</b>    <b>TILT CYL INSTALLED?</b> L2 <b>M x x x x</b>    <b>NO / YES</b> L1 <b>C x x x x</b>    <b>REEL FORE / AFT?</b> L2 <b>M x x x x</b>    <b>NO / YES</b> L1 <b>C x x x x</b>    <b>KNIFE OVERLOAD SPD?</b> L2 <b>M x x x x</b>    <b>1000 SPM</b> L1 <b>C x x x x</b>    <b>HEADER INDEX MODE?</b> L2 <b>M x x x x</b>    <b>REEL &amp; CONVEYOR</b> L2 <b>M x x x x</b>    <b>REEL ONLY</b> L1 <b>C x x x x</b>    <b>RETURN TO CUT MODE?</b> L2 <b>M x x x x</b>    <b>HEIGHT &amp; TILT</b> L2 <b>M x x x x</b>    <b>HEIGHT ONLY</b> L1 <b>C x x x x</b>    <b>HEADER CUT WIDTH?</b> L2 <b>M x x x x</b>    <b>20.5 FEET</b> L1 <b>C x x x x</b>    <b>HAY CONDITIONER?</b> L2 <b>M x x x x</b>    <b>NO / YES</b> L1 <b>C x x x x</b>    <b>AUGER HDR REEL SPD</b> L2 <b>M x x x x</b>    <b>RPM / MPH</b> L2 <b>M x x x x</b>    <b>RPM / KPH</b> L1 <b>C x x x x</b>    <b>SET TIRE SIZE?</b> L2 <b>M x x x x</b>    <b>18.4 X 26 TURF</b> L2 <b>M x x x x</b>    <b>18.4 X 26 BAR</b> L2 <b>M x x x x</b>    <b>23.1 X 26 TURF</b> L2 <b>M x x x x</b>    <b>600 - 65 R 28</b> L1 <b>C x x x x</b>    <b>SET ENGINE ISC RPM?</b> L2 <b>M x x x x</b>    <b>OFF / ON</b>	<div style="border: 1px solid black; padding: 5px; margin-bottom: 10px;">                 Selects the header type, the selected header will be flashing. The "factory" default to be DRAPER.             </div> <div style="border: 1px solid black; padding: 5px; margin-bottom: 10px;">                 If the A30 is selected them the reel speed should be suppressed as there is no reel speed sensor.             </div> <div style="border: 1px solid black; padding: 5px; margin-bottom: 10px;">                 If a DRAPER or A40 is selected the reel speed should be enabled (with expansion module installed).                  The TILT selection needs to be available even if the expansion module is not installed.             </div> <div style="border: 1px solid black; padding: 5px; margin-bottom: 10px;">                 Knife Overload Speed should be suppressed unless the expansion module is installed.             </div> <div style="border: 1px solid black; padding: 5px; margin-bottom: 10px;">                 If the REEL SPEED sensor is not "installed" (A30 Auger Header selected) in the TRACTOR SETUP menu, the INDEX mode should be suppressed.             </div> <div style="border: 1px solid black; padding: 5px; margin-bottom: 10px;">                 If the HEADER TILT sensor is not "installed" (no expansion module installed), then the RTC mode should default to HEIGHT only.             </div> <div style="border: 1px solid black; padding: 5px; margin-bottom: 10px;">                 Use the "arrow" keys to set the header cut width.             </div> <div style="border: 1px solid black; padding: 5px; margin-bottom: 10px;">                 DRAPER HEADER ONLY. Default will be flashing.                  Use "arrow" keys to select.             </div> <div style="border: 1px solid black; padding: 5px; margin-bottom: 10px;">                 AUGER HEADER ONLY                  For IMPERIAL display.                  For METRIC display.             </div> <div style="border: 1px solid black; padding: 5px; margin-bottom: 10px;">                 Pressing "SELECT" will go to the next line 1 (L1) menu selection. The turn signal "arrow" keys are used to change the values.             </div> <div style="border: 1px solid black; padding: 5px;">                 Pressing "SELECT" will jump to:  <b>SET CONTROL LOCKS?</b> </div>	

*(continued next page)*

# OPERATOR'S STATION

L1 C x x x || SET CONTROL LOCKS? If "NO" then jump to:  
 L2 M x x x ||  NO / YES  VIEW CONTROL LOCKS?

L1 C x x x || DRAPER SPEED  
 L2 M x x x ||  ENABLED / LOCKED

L1 C x x x || AUGER SPEED  
 L2 M x x x ||  ENABLED / LOCKED

L1 C x x x || REEL SPEED  
 L2 M x x x ||  ENABLED / LOCKED

L1 C x x x || REEL FORE / AFT  
 L2 M x x x ||  ENABLED / LOCKED

L1 C x x x || HEADER TILT  
 L2 M x x x ||  ENABLED / LOCKED

L1 C x x x || EXIT CONTROL LOCKS?  
 L2 M x x x ||  NO / YES

This menu allows the operator to selectively "lock out" the control functions for the various header functions. The default or selected "status" for each item will flash.

If the expansion module is not installed the corresponding menu items should be suppressed.

The "arrow" keys are used to ENABLE or LOCK OUT each function. Pressing "SELECT" will go to the next L1 menu item.

Tilt to be suppressed if not "installed" in the tractor setup menu.

If "NO" then jump to:  
 DRAPER SPEED  
 ENABLED / LOCKED

L1 C x x x || VIEW CONTROL LOCKS? If "NO" then jump to:  
 L2 M x x x ||  NO / YES  EXIT TRACTOR SETUP?

L1 C x x x || DRAPER SPEED    
 L2 M x x x || 575.1 HRS ENABLED  
 L2 M x x x || 648.6 HRS LOCKED

L1 C x x x || AUGER SPEED    
 L2 M x x x || 575.1 HRS ENABLED  
 L2 M x x x || 648.6 HRS LOCKED

L1 C x x x || REEL SPEED    
 L2 M x x x || 575.1 HRS ENABLED  
 L2 M x x x || 648.6 HRS LOCKED

L1 C x x x || REEL FORE / AFT    
 L2 M x x x || 575.1 HRS ENABLED  
 L2 M x x x || 648.6 HRS LOCKED

L1 C x x x || HEADER TILT    
 L2 M x x x || 575.1 HRS ENABLED  
 L2 M x x x || 648.6 HRS LOCKED

L1 C x x x || EXIT VIEW LOCKOUTS?  
 L2 M x x x ||  NO / YES

When the control lock outs are viewed, the lower display line (L2) will show the engine hours and either ENABLED or LOCKED to indicate the present status along with the engine hours at which time the function was either ENABLED or LOCKED.

Using the "arrow" keys allows the operator to select the various functions. Pressing "SELECT" will go to the EXIT VIEW LOCKOUTS? menu selection.

If any of the HDR ANGLE / KNIFE SPEED or REEL SPEED sensors are not "installed" (no expansion module or A30 Auger header selected), they should be suppressed.

If "NO" then jump to:  
 DRAPER SPEED

L1 C x x x || EXIT TRACTOR SETUP? If "NO" then jump to:  
 L2 M x x x ||  NO / YES  TILT CYL INSTALLED?

L1 C x x x || CAB DISPLAY SETUP? If "NO" then jump to:  
 L2 M x x x ||  NO / YES  CALIBRATE SENSORS?

L1 C x x x || DISPLAY LANGUAGE?  
 L2 M x x x ||  ENGLISH

L2 M x x x ||  ESPANOL

L2 M x x x ||  RUSSIAN

L1 C x x x || DISPLAY UNITS?  
 L2 M x x x ||  IMPERIAL

L2 M x x x ||  METRIC

Use the "arrow" keys to change the default language. Pressing "SELECT" goes to the next L1 menu selection.

The "arrow" keys are used to select between IMPERIAL or METRIC. The default value will be displayed first.

*(continued next page)*

## OPERATOR'S STATION

L1	C x x x    CDM BUZZER VOLUME
L2	M x x x
L1	C x x x    CDM BACKLIGHTING
L2	M x x x
L1	C x x x    CDM CONTRAST
L2	M x x x
L1	C x x x    EXIT DISPLAY SETUP?
L2	M x x x     NO / YES

The "arrow" keys are used to change the CDM buzzer volume, CDM backlighting or the CDM contrast, with the bar graph indicating the relative level for each item. When "SELECT" is pressed the program goes to the EXIT DISPLAY SETUP? menu selection.

if "NO" then jump to:  
 DISPLAY LANGUAGE?

L1	C x x x    CALIBRATE SENSORS?
L2	M x x x     NO / YES

if "NO" then jump to:  
 DIAGNOSTIC MODE?

	L1	C x x x    TO CALIBRATE SELECT
	L2	M x x x     HEADER HEIGHT
	L2	M x x x     HEADER TILT
	L2	M x x x     STOP & EXIT
	L1	C x x x    HEIGHT SENSOR CAL
	L2	M x x x    RAISE HDR TO START
	L1	C x x x    CALIBRATING HEIGHT
	L2	M x x x    RAISE HEADER HOLD
	L2	M x x x    RAISE HEADER DONE
	L1	C x x x    HEIGHT SENSOR CAL
	L2	M x x x    PRESS LOWER HEADER
	L1	M x x x    CALIBRATING HEIGHT
	L2	M x x x    LOWER HEADER HOLD
	L2	M x x x    HT SENSOR COMPLETE
	L1	C x x x    TO CALIBRATE SELECT
	L2	M x x x     HEADER HEIGHT
	L1	C x x x    TO CALIBRATE SELECT
	L2	M x x x     HEADER HEIGHT
	L2	M x x x     HEADER TILT
	L1	M x x x    HDR TILT SENSOR CAL
	L2	M x x x    EXTEND TLT TO START
	L1	C x x x    CALIBRATING TILT
	L2	M x x x    EXTEND TILT HOLD
	L2	M x x x    EXTEND TILT DONE
	L1	M x x x    HDR TILT SENSOR CAL
	L2	M x x x    PRESS RETRACT TILT
	L1	C x x x    CALIBRATING TILT
	L2	M x x x    RETRACT TILT HOLD
	L2	M x x x    HDR TILT COMPLETE
	L1	C x x x    TO CALIBRATE SELECT
	L2	M x x x     HEADER TILT
	L2	M x x x     STOP & EXIT
	L1	C x x x    EXIT CALIBRATION?
	L2	M x x x     NO / YES

The operator can select any of the two items requiring calibration or to STOP & EXIT the menu.

When a function is activated, the display will indicate the function being calibrated. HOLD will flash until the system has completed reading in the signal with the header fully raised.

DONE will flash and prompt the operator to COMPLETE the sensor calibration by lowering the header.

The menu will display the last item selected when the calibration routine is completed.

If the HEADER TILT option in the TRACTOR SETUP is set to NO then only HEIGHT should be available as a menu selection for calibration.

if "NO" then jump to:  
 TO CALIBRATE SELECT

*(continued next page)*

# OPERATOR'S STATION

L1	C x x x    DIAGNOSTIC MODE? <span style="float: right;">↔</span>	if "NO" then jump to:
L2	M x x x    <span style="float: left;">←</span> NO / YES <span style="float: right;">→</span>	TRACTOR SETUP? <span style="float: right;">↔</span>
↳		
L1	C x x x    VIEW ERROR CODES? <span style="float: right;">↔</span>	if "NO" then jump to:
L2	M x x x    <span style="float: left;">←</span> NO / YES <span style="float: right;">→</span>	ENTER SENSOR SETUP? <span style="float: right;">↔</span>
↳		
L1	C x x x    VIEW TRACTOR CODES? <span style="float: right;">↔</span>	if "NO" then jump to:
L2	M x x x    <span style="float: left;">←</span> NO / YES <span style="float: right;">→</span>	ENTER SENSOR SETUP? <span style="float: right;">↔</span>
L1	1    1 2 3 4 . 5 HRS 1 2 3 <span style="float: right;">↔</span>	The last 10 distinct error codes are stored along with the code #, Exxx, engine hours and number of occurrences. The "arrow" keys are used to cycle between codes.
L2	E 4 7    SENSOR VOLTS LOW <span style="float: right;">↔</span>	
L1	2    1 2 3 4 . 5 HRS 1 2 3 <span style="float: right;">↔</span>	
L2	E 7 1    LOW HYDRAULIC OIL <span style="float: right;">↔</span>	
L1	C x x x    EXIT TRACTOR CODES? <span style="float: right;">↔</span>	if "NO" then jump to:
L2	M x x x    <span style="float: left;">←</span> NO / YES <span style="float: right;">→</span>	VIEW TRACTOR CODES? <span style="float: right;">↔</span>
↳		
L1	C x x x    ENTER SENSOR SETUP? <span style="float: right;">↔</span>	if "NO" then jump to:
L2	M x x x    <span style="float: left;">←</span> NO / YES <span style="float: right;">→</span>	READ SENSOR INPUTS? <span style="float: right;">↔</span>
↳		
L1	C x x x    HEADER HT SENSOR <span style="float: right;">↔</span>	The operator can select each sensor and selectively enable or disable the sensor in the event of a sensor malfunction.
L2	M x x x    <span style="float: left;">←</span> ENABLE / DISABLE <span style="float: right;">→</span>	
L1	C x x x    HEADER TILT SENSOR <span style="float: right;">↔</span>	If no expansion module or an A30 auger header is selected, the corresponding menu items should be suppressed.
L2	M x x x    <span style="float: left;">←</span> ENABLE / DISABLE <span style="float: right;">→</span>	
L1	C x x x    KNIFE SPEED SENSOR <span style="float: right;">↔</span>	When "SELECT" is pressed the program goes to the EXIT SENSOR SETUP? selection.
L2	M x x x    <span style="float: left;">←</span> ENABLE / DISABLE <span style="float: right;">→</span>	
L1	C x x x    REEL SPEED SENSOR <span style="float: right;">↔</span>	
L2	M x x x    <span style="float: left;">←</span> ENABLE / DISABLE <span style="float: right;">→</span>	
L1	C x x x    EXIT SENSOR SETUP? <span style="float: right;">↔</span>	if "NO" then jump to:
L2	M x x x    <span style="float: left;">←</span> NO / YES <span style="float: right;">→</span>	KNIFE SPEED SENSOR <span style="float: right;">↔</span>
↳		
Or to the first sensor "installed"		
↳		
L1	C x x x    READ SENSOR INPUTS? <span style="float: right;">↔</span>	if "NO" then jump to:
L2	M x x x    <span style="float: left;">←</span> NO / YES <span style="float: right;">→</span>	ACTIVATE FUNCTIONS? <span style="float: right;">↔</span>
↳		
L1	C x x x    SENSOR INPUT <span style="float: right;">↔</span>	For diagnostic purposes each sensors input signal can be read.
L2	M x x x    HDR HEIGHT 3 . 5 9 V <span style="float: right;">↔</span>	
L1	C x x x    SENSOR INPUT <span style="float: right;">↔</span>	If no expansion module or an A30 auger header is selected, the corresponding menu items should be suppressed.
L2	M x x x    HEADER ANGLE 1 . 8 4 V <span style="float: right;">↔</span>	
L1	C x x x    SENSOR INPUT <span style="float: right;">↔</span>	When "SELECT" is pressed the program goes to the EXIT READ SENSORS? menu selection.
L2	M x x x    KNIFE SPEED 1 2 3 H Z <span style="float: right;">↔</span>	
L1	C x x x    SENSOR INPUT <span style="float: right;">↔</span>	
L2	M x x x    REEL SPEED 1 2 3 H Z <span style="float: right;">↔</span>	
L1	C x x x    SENSOR INPUT <span style="float: right;">↔</span>	Adds a selection to be able to read in the wheel speed frequency.
L2	M x x x    WHEEL SPEED 1 2 3 H Z <span style="float: right;">↔</span>	
L1	C x x x    EXIT READ SENSORS? <span style="float: right;">↔</span>	if "NO" then jump to:
L2	M x x x    <span style="float: left;">←</span> NO / YES <span style="float: right;">→</span>	SENSOR INPUT <span style="float: right;">↔</span>
↳		
HDR HEIGHT 3 . 5 9 V		

*(continued next page)*

# OPERATOR'S STATION

L1 | C x x x || S E N S O R I N P U T    ← →  
 L2 | M x x x || H D R H E I G H T    S E N S O R

L1 | C x x x || S E N S O R I N P U T    ← →  
 L2 | M x x x || H E A D E R A N G L E S E N S O R

L1 | C x x x || S E N S O R I N P U T    ← →  
 L2 | M x x x || K N I F E S P E E D    S E N S O R

L1 | C x x x || S E N S O R I N P U T    ← →  
 L2 | M x x x || R E E L S P E E D    S E N S O R

If a sensor has been disabled "SENSOR" will be flashing in the area where the input reading would have been.

If no expansion module or an A30 auger header is selected, the corresponding menu items should be suppressed.

L1 | C x x x || A C T I V A T E F U N C T I O N S ?    If "NO" then jump to:  
 L2 | M x x x || ←    N O / Y E S    →    E X I T D I A G N O S T I C S ?

↳ L1 | C x x x || A C T I V A T E F U N C T I O N S ?  
 L2 | M x x x || H E A D E R ← D O W N / U P →

L1 | C x x x || A C T I V A T E F U N C T I O N S ?  
 L2 | M x x x || R E E L ← D O W N / U P →

L1 | C x x x || A C T I V A T E F U N C T I O N S ?  
 L2 | M x x x || H D R T I L T ← I N / O U T →

L1 | C x x x || A C T I V A T E F U N C T I O N S ?  
 L2 | M x x x || K N I F E D R I V E O N →

L1 | C x x x || A C T I V A T E F U N C T I O N S ?  
 L2 | M x x x || D R A P E R / A U G E R O N →

L1 | C x x x || A C T I V A T E F U N C T I O N S ?  
 L2 | M x x x || R E E L ← F O R E / A F T →

L1 | C x x x || A C T I V A T E H Y D P U R G E ?  
 L2 | M x x x || ←    N O / Y E S    →

L1 | C x x x || T O A C T I V A T E P U R G E  
 L2 | M x x x || P R E S S A N D H O L D →

L1 | C x x x || P U R G E C Y C L E S T A R T E D  
 L2 | M x x x || P R E S S A N D H O L D →

L1 | C x x x || P U R G E C Y C L E E N D E D  
 L2 | M x x x ||

L1 | C x x x || P U R G E C Y C L E E N D E D  
 L2 | M x x x || ← N O    E X I T    Y E S →

L1 | C x x x || E X I T F U N C T I O N M E N U ?  
 L2 | M x x x || ←    N O / Y E S    →

L1 | C x x x || E X I T D I A G N O S T I C S ?  
 L2 | M x x x || ←    N O / Y E S    →

For diagnostic purposes each header function can be activated by using the "arrow" keys on the CDM. When "SELECT" is pressed the program will go to the next function that can be activated.

If the HEADER TILT cylinder or the REEL FORE / AFT valve is not installed under the TRACTOR SETUP menu then the ACTIVATE FUNCTIONS menu selection for these items should be suppressed.

ACTIVATE HYD PURGE - This is to allow the operator to purge the air from a new or changed pump system.

Pressing and holding the right hand "arrow" button activates a predetermined timed purge cycle. Releasing pressure on the switch or a completed cycle (timed out) will jump to the PURGE CYCLE ENDED menu selection.

If "NO" then jump to:  
 H E A D E R ← D O W N / U P →

If "NO" then jump to:  
 D I A G N O S T I C M O D E ?



## OPERATOR'S STATION

### **5.18.6 Engine Error Codes**

The CDM displays Error Codes when there is a fault with one of the several sensors that monitor and control engine operation, to assist the Operator or Technician in locating a specific problem with engine operation.

Refer to pages 197 - 203 for **Engine Error Codes**.

### **5.18.7 CDM and WCM Fault Codes**

The CDM displays Fault Codes when there is a fault with one of the several sensors that monitor and control windrower operation, to assist the Operator or Technician in locating a specific problem with the windrower.

Refer to pages 195 - 196 for **CDM and WCM Fault Codes**.

# WINDROWER OPERATION

## 6 OPERATION

### 6.1 OWNER/OPERATOR RESPONSIBILITIES



#### CAUTION













- It is your responsibility to read and understand this manual completely before operating the windrower. Contact your Dealer if an instruction is not clear to you.
- Follow all safety messages in the manual and on safety signs on the machine.
- Remember that YOU are the key to safety. Good safety practices protect you and the people around you.
- Before allowing anyone to operate the windrower, for however short a time or distance, make sure they have been instructed in its safe and proper use.
- Review the manual and all safety related items with all Operators annually.
- Be alert for other Operators not using recommended procedures or not following safety precautions. Correct these mistakes immediately, before an accident occurs.
- Do not modify the machine. Unauthorized modifications may impair the function and/or safety and affect machine life.
- The safety information given in this manual does not replace safety codes, insurance needs, or laws governing your area. Be sure your machine meets the standards set by these regulations.

### 6.2 SYMBOL DEFINITIONS

The following symbols are used to depict functions or reactions at the various instruments and controls.

Learn the meaning of these symbols before operating the windrower.



















#### 6.2.1 Engine Functions

	Electrical Power - Accessories		Engine Stop
	Engine Coolant Temperature		Engine Throttle
	Engine Glow Plugs		Engine Urgent Stop
	Engine Malfunction		Fast
	Engine Rpm		Slow
	Engine Run		Water In Fuel
	Engine Start		





























*(continued next page)*

# WINDROWER OPERATION

## 6.2.2 Windrower Operating Symbols

	Turn Signals		Windshield Wiper
	Hazard Warning Lights		Seat Height Up
<b>F</b>	Forward		Seat Height Down
<b>N</b>	Neutral		Seat Fore and Aft
<b>R</b>	Reverse		Seat Fore Aft Isolator
	Headlights Low Beam/Road Lights		Seat Back Fore and Aft
	Headlights High Beam/Road Lights		Seat Ride Damping
	Work Light		Cab Temperature Control
	Lighter		Blower
	Air Conditioning		Fresh Air
	Recirculate		

## 6.2.3 Header Functions

	Program		Header Tilt Up
	Header Index		Header Down
	Return To Cut		Header Up
	Conveyor/Auger Speed		Header Tilt Down
	Float Left		Increase
	Float Right		Decrease
	Reel Speed		Deck Shift
	Disc Speed		Float
	Reel Down		Header Engage
	Reel Forward		Header Disengage
	Reel Up		Push Down Header Disengage
	Reel Rearward		Pull Up Header Engage
	Display Select		Header Reverse
	DWA Down		DWA Up
	DWA Draper Speed		

## WINDROWER OPERATION

### 6.3 WINDROWER OPERATION

#### 6.3.1 Operational Safety

Follow these safety precautions:



#### CAUTION

- Wear close fitting clothing and protective shoes with slip resistant soles.
- Remove foreign objects from the machine and surrounding area.
- As well, carry with you any protective clothing and personal safety devices that **COULD** be necessary through the day. Don't take chances.
- You may need:

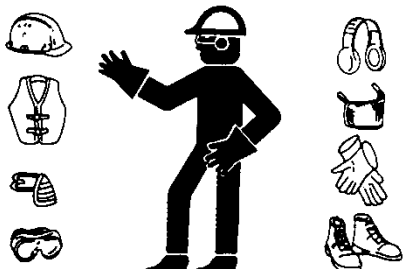

- a hard hat.
  - protective glasses or goggles.
  - heavy gloves.
  - respirator or filter mask.
  - wet weather gear.
- Protect against noise. Wear a suitable hearing protective device such as ear muffs or ear plugs to protect against objectionable or uncomfortable loud noises.
  - Follow all safety and operational instructions given in your Operator's Manuals. If you do not have a header manual, get one from your Dealer, and read it thoroughly.
  - Never attempt to start the engine or operate the machine except from the Operator's seat.
  - Check the operation of all controls in a safe clear area before starting work.



- Check for excessive vibration and unusual noises. If there is any indication of trouble, shut down and inspect the machine. Follow proper shutdown procedure. Refer to Section 6.3.4.3 Shutdown.
- Operate only in daylight or good artificial light.

#### 6.3.2 Break-In Period

The windrower is ready for normal operation. However there are several items to check and watch out for during the first 150 hours. In addition to the following, perform the items specified in Section 7.4.2 *Break-In Inspections*.



#### DANGER

Before investigating an unusual sound or attempting to correct a problem, place **GSL** in **N-DETENT**, shut off engine, and remove key.

#### IMPORTANT

Until you become familiar with the sound and feel of your new windrower, be extra alert and attentive.

- Operate engine at moderate load, and avoid extremely heavy or light loading for longer than 5 minutes.
- Avoid unnecessary idling. If engine will be idling for longer than 5 minutes after reaching operating temperature, turn the key OFF to stop engine.
- Check engine oil level frequently. Watch for any signs of leakage. If oil must be added, refer to Section 7.8.3 *Oil Level*.

#### NOTE

*During the break-in period, a higher than usual oil consumption should be considered normal.*

#### NOTE

*If windrower must be driven in cold weather (i.e. below freezing), let engine idle for 3 minutes, and then operate at moderate speed until oil has warmed up.*

- Watch CDM display for temperature rising beyond normal operating range. Check that coolant level at reserve tank (mounted next to radiator) stays between HOT and COLD marks on tank. Refer to Section 7.8.7 *Engine Cooling System*. If over-heating problems occur, check for coolant leaks.

## WINDROWER OPERATION

### 6.3.3 Daily Check

- a. Check the machine for leaks or any parts that are missing, broken, or not working correctly.

**NOTE:**

*Use proper procedure when searching for pressurized fluid leaks. Refer to Section 7.11.6 Hoses and Lines.*

- b. Clean the windows and mirrors to be sure of good visibility in all directions. Stand on the platform to access the rear window. Hold onto the hand-holds on the cab front corners, and stand on the header anti-slip strips to wash the front window.
- c. Clean all lights and reflective surfaces to maintain visibility to others.
- d. Perform Daily maintenance. Refer to Section 7.4 MAINTENANCE REQUIREMENTS.

## WINDROWER OPERATION

### 6.3.4 Engine Operation

#### 6.3.4.1 Starting



### DANGER

- Avoid possible injury or death from a runaway machine.
- This machine has safety devices which allow the engine to start only when the ground speed lever is in N-DETENT, the steering wheel is locked in the NEUTRAL position, and the header drive switch is OFF. Under no circumstances are these devices to be deliberately rewired or misadjusted so that the engine can be started with controls out of NEUTRAL.
- Do not start engine by shorting across starter or starter relay terminals. Machine will start with drive engaged and move if normal starting circuitry is bypassed.
- Start engine only from Operator's seat with controls in NEUTRAL. NEVER start engine while standing on ground. Never try to start engine with someone under or near machine.
- Before starting engine, be sure there is plenty of ventilation to avoid asphyxiation.

#### IMPORTANT

Do not tow machine to start engine. Damage to hydrostatic drives will result.



### WARNING

- Before starting engine, securely fasten your seat belt, and ensure Trainer's seat belt is fastened (if occupied).
- The seat belt can help ensure your safety if it is used and maintained.

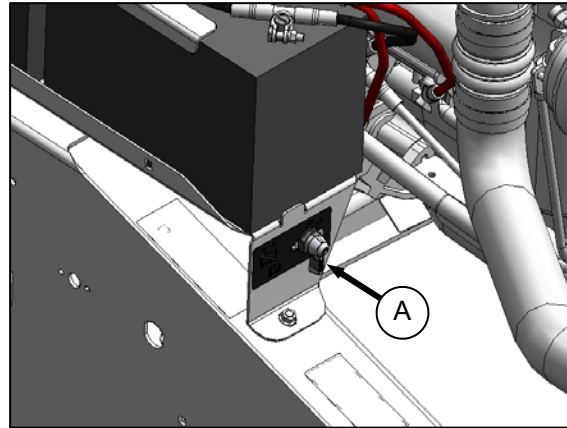

- a. A battery main disconnect switch (A) is located on the battery support in the engine compartment. Ensure switch is switched to POWER ON.

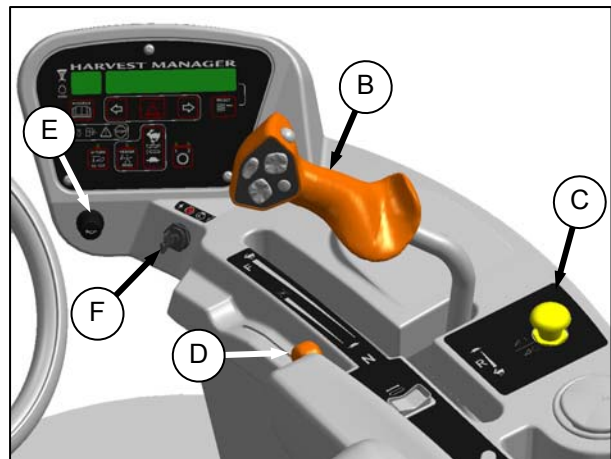

- b. Move GSL (B) into N-DETENT.
- c. Turn steering wheel until it locks.
- d. Fasten seat belt.
- e. Push HEADER DRIVE switch (C) to OFF.
- f. **Normal Start: Engine temperature above 60°F (16°C).**
  1. Set throttle (D) to START position - fully back.

#### IMPORTANT

The machine gauges and instruments provide important information about machine operation and condition. Familiarize yourself with the gauges and monitor them carefully during start-up operation. Refer to Section 5.15 ENGINE CONTROLS.

2. Sound horn (E) three times.
3. Turn ignition key (F) to RUN.

*(continued next page)*

## WINDROWER OPERATION



### CAUTION

Be sure the area is clear of other persons, pets etc. before proceeding.

4. Single loud tone sounds, engine warning lights illuminate, and CDM displays "HEADER DISENGAGED" and "IN PARK".
5. Turn ignition key to START until engine starts, and then release key.

### IMPORTANT

Do not operate starter for longer than 15 seconds at a time. If engine does not start, wait at least two minutes before trying again. After the third 15 second crank attempt, allow solenoid to cool for 10 minutes before further cranking attempts. If engine still does not start, refer to Section 8 TROUBLESHOOTING.



### WARNING

If starter engages with steering wheel unlocked, ground speed lever out of NEUTRAL, or header clutch/drive engaged, **DO NOT START ENGINE**. See your Dealer.

- g. Cold Start: Engine temperature below 40°F (5°C).

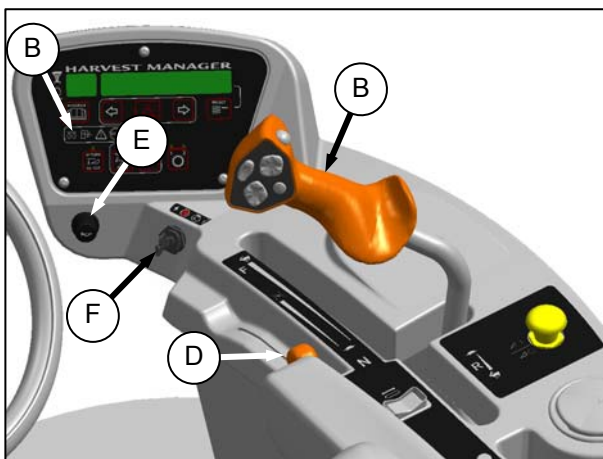

1. Set throttle (D) to START position - fully back (low idle).
2. Turn key (F) to RUN.
3. Grid heater light (G) on CDM will cycle ON / OFF / ON after 2 seconds for a pre-set length of time. The operating period for the glow plug light will change depending engine temperature.

4. Sound horn (E) three times.
5. When grid heater light goes out, turn key to START, and crank engine until it starts. Leave throttle at IDLE.
6. If engine fails to start, repeat steps 2 to 5.
7. Engine will cycle through a period where it appears to labor.

### NOTE

Throttle is non-responsive during this time as engine is in WARM UP mode. This mode will last from 30 seconds to 3 minutes depending on temperature. After engine has stabilized and idling normally, throttle becomes active.



### IMPORTANT

Do not operate engine above 1500 rpm until engine temperature is above 100°F (38°C).

### IMPORTANT

Do not operate starter for longer than 15 seconds at a time. If engine does not start, wait at least two minutes before trying again. After the third 15 second crank attempt, allow solenoid to cool for 10 minutes before further cranking attempts. If engine still does not start, refer to Section 8 TROUBLESHOOTING.



### WARNING

If starter engages with steering wheel unlocked, ground speed lever out of NEUTRAL, or header drive/clutch engaged, **DO NOT START ENGINE**. See your Dealer.

## WINDROWER OPERATION

### 6.3.4.2 Engine Intermediate Speed Control (ISC)

This is useful when operating loads are reduced such as in light crop conditions that do not require the maximum engine rpm.

Reduced engine speed lowers fuel consumption, noise levels, and exhaust emissions, in addition to reducing engine wear.

With the ISC activated, the engine speed automatically reverts to 2200 rpm when the header is engaged.

Refer to Section 5.18.5 *Cab Display Monitor (CDM) Programming* for instructions on activating / de-activating engine ISC.

### 6.3.4.3 Shutdown



#### CAUTION

Be sure windrower is safely parked on a flat, level surface; header is on the ground, and the NEUTRAL lock/brakes are engaged.

#### IMPORTANT

Before stopping engine, run at low idle for approximately five minutes to cool hot engine parts.

Turn key counter clockwise to OFF.

### 6.3.4.4 Fueling



#### WARNING



- To avoid personal injury or death from explosion or fire, do **not** smoke or allow flame or sparks near fuel tank when refueling.
- Never refuel the windrower when the engine is hot or running.

- a. Stop windrower, and remove key.
- b. Stand on platform to access fuel tank filler pipe.

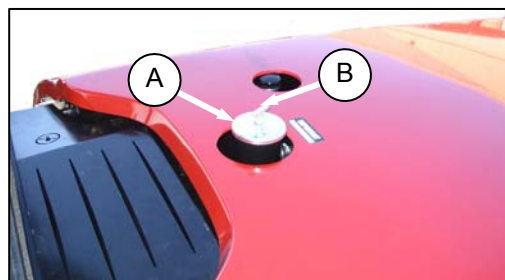

- c. Clean the area around the filler cap (A).
- d. Turn cap handle (B) counter clockwise until loose, and remove cap.
- e. Fill tank with approved fuel as per Section 7.3.2.1 Fuel.
- f. Replace fuel tank cap (A), and turn cap handle (B) clockwise until snug.

#### NOTE

Fill fuel tank *daily*, preferably at the end of the day's operation to help prevent condensation in the tank. Tank Capacity is 97 U.S. Gallons (367 L).

#### IMPORTANT

Do **not** fill tank completely; space is required for expansion. A filled tank could overflow if exposed to a rise in temperature, such as direct sunlight.

#### IMPORTANT

Do **not** allow tank to empty. Running out of fuel can cause air locks and/or contamination of the fuel system. Refer to Section 7.8.6 *Fuel System* for priming procedures.



# WINDROWER OPERATION

## 6.3.4.5 Engine Temperature

The normal engine operating temperature range is 180° - 225°F (82° - 107°C).

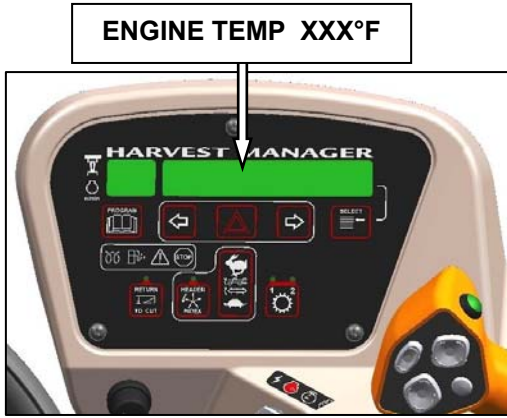

If the temperature exceeds 230°F (110°C), an ongoing intermittent tone will be heard, and the CDM will flash “ENGINE TEMP”.

Stop the engine **immediately**, and determine cause. The tone will stop, and the CDM will return to normal when the temperature drops below 225°F (107°C).

## 6.3.4.6 Engine Oil Pressure

The nominal engine oil pressure is 10 psi (69 kPa) at low idle, and 55.1 psi (380 kPa) at maximum rated speed.

The nominal engine oil pressure is 10 psi (69 kPa) at low idle, and 55.1 psi (380 kPa) at maximum rated speed.

If oil pressure drops below preset level of 7.5 psi (52 kPa), CDM displays an error code and error message flashes.

If STOP ENGINE light appears, stop the engine immediately and investigate.

If yellow CAUTION light illuminates, stopping immediately is optional. Operator may continue operations and investigate later, but it is strongly advised to monitor the situation carefully.

## 6.3.4.7 Electrical

IGNITION	ENGINE	READING	INDICATED CONDITION
ON	Running	13.8 - 15.0	Normal.
		> 16.0 See Note.	Regulator Out of Adjustment.
	< 12.5 See Note.	Alternator Not Working or Regulator Out of Adjustment.	
	Shutdown	12.0	Battery Normal.

### NOTE

Display flashes voltage reading with single loud tone. Repeats every 30 minutes until condition fixed.

The electrical system voltage is displayed on the CDM when selected with the SELECT button on the GSL handle, or the SELECT switch on the CDM. The display indicates the condition of the battery and alternator. Refer to table above.

## 6.3.4.8 Engine Warning Lights

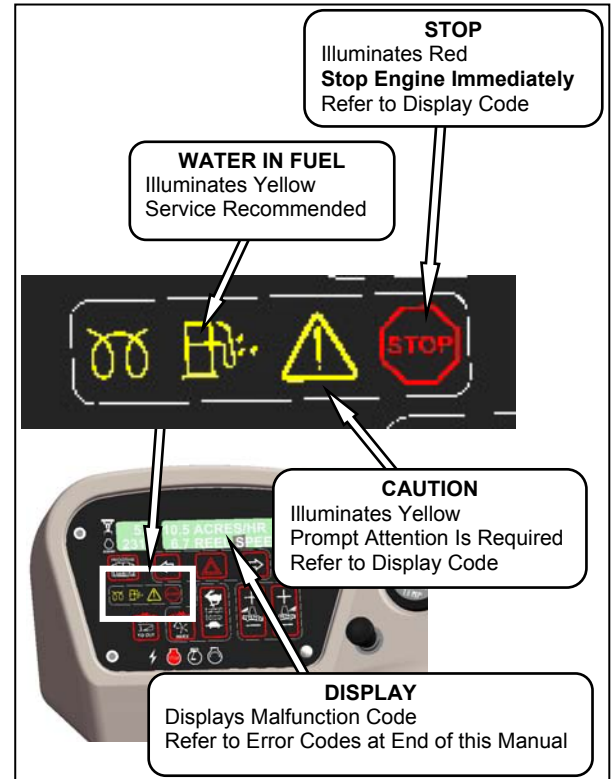

There are four engine warning lights that illuminate if abnormal conditions occur while the engine is running. The engine warning lights should **not** be illuminated under normal operating conditions.

## WINDROWER OPERATION

### 6.3.5 Driving The Windrower



#### WARNING

Before starting engine, securely fasten your seat belt, and ensure Trainer's seat belt is fastened (if occupied). The seat belt can help ensure your safety if it is used and maintained.



#### WARNING

- Avoid driving the machine with header removed. Removing header decreases the weight on drive wheels, reducing steering control.



- If necessary to drive machine with header removed, use transmission field speed range, do not exceed 1500 rpm engine speed, and avoid loose gravel and slopes.
- Never use windrower as a towing vehicle when header is removed, except as instructed in Section 6.3.7.2 Towing Header With Windrower. There is insufficient weight on the drive wheels to provide steering control.
- Because of windrower shape characteristics, a roll-over protected (ROPS) cab is not required. If operating with header removed, be aware that cab structure will not withstand a roll-over.



#### CAUTION

##### HYDROSTATIC STEERING

The machine is steered hydrostatically, that is, turning the steering wheel varies the hydraulic flow to one drive wheel relative to the other drive wheel.

The reaction of this type of steering is different than conventional steering mechanisms.



#### CAUTION

- With the engine running, moving the ground speed lever out of N-DETENT unlocks steering. Any movement of steering wheel will then cause the machine to move, even if the ground speed lever has not been moved forward or rearward from the NEUTRAL position.
- Hydrostatic steering is more sensitive than mechanical steering.
- Steering is opposite to normal when driving in reverse.
- The brakes are only on when the GSL is in N-DETENT, and the steering wheel is centered and locked.



#### DANGER

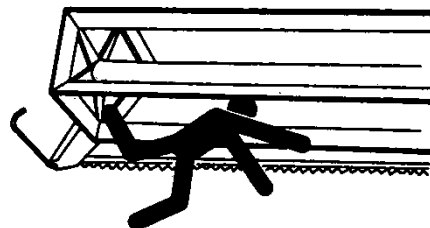

- Never move ground speed lever or steering wheel until you are sure all bystanders have cleared the area.
- Be sure area is clear before making turns as ends of header travel in a large arc.
- Check the operation of all controls in a safe, clear area before starting work. Be sure you know the capacity and operating characteristics of this machine.

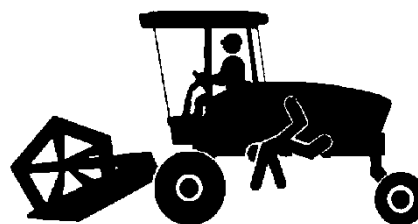

- Do not allow riders in or on the machine.
- Operate only while seated in the Operator's location.
- Never attempt to get on or off a moving windrower.
- Avoid sudden starts and stops.

*(continued next page)*

## WINDROWER OPERATION

- Avoid inclines, ditches and fences.
- Do **not** rapidly accelerate or decelerate when turning
- Reduce speed before turning, crossing slopes, or travelling over rough ground.
- Do **not** allow anyone to stand behind the machine while operating. Foreign objects may be forcibly ejected.

### 6.3.5.1 Ingress/Egress



#### CAUTION

- To provide more secure hand and foot mobility, preventing slipping and possible injury, always face the windrower, and use the hand rail when dismounting (or mounting).
- Never attempt to get on or off a moving windrower.
- Before leaving the Operator's seat for any reason:
  - Park on level ground if possible.
  - Be sure the ground speed lever is in **N-DETENT**, and the steering wheel is locked in the straight-ahead position.
  - Fully lower header and reel.
  - Disengage header drives.
  - Stop engine, and remove key from ignition. A child or even a pet could engage an idling machine.
  - Turn off windshield wiper.
  - Turn off lights (unless required for inspection purposes).
  - Release seat belt.
  - Raise armrest and steering wheel for easier exit and re-entry.
  - Lock the cab door when leaving the windrower unattended. (When the door is locked, it can still be opened from inside the cab.)

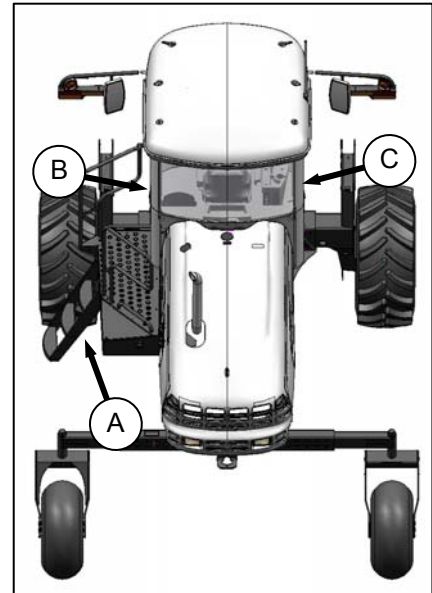

A swing away platform and steps (A) are provided to accommodate access to the Operator's station, as well as maintenance tasks.

Opposite to the entry/exit door (B) is a door-size window (C) that latches in the partially open position if desired, and can be fully opened for emergency exit.

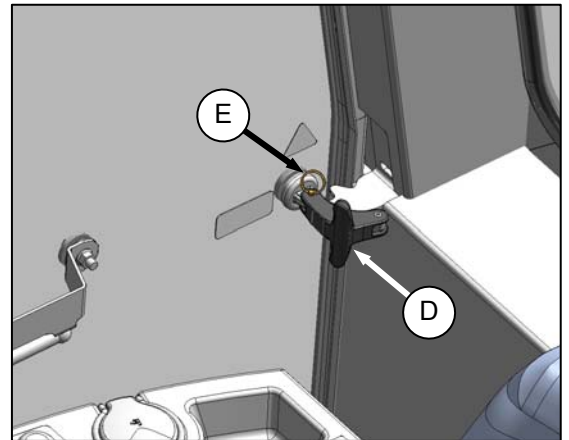

To open right side window, pull over-center latch (D) forward, and slightly push on window until latch goes over-center, and lock window in OPEN position.

To close, pull latch (D) inward to until window closes, and then push rearward to lock.

To fully open window, pull pin (E) out of latch, and push window open

# WINDROWER OPERATION

## 6.3.5.2 Operation

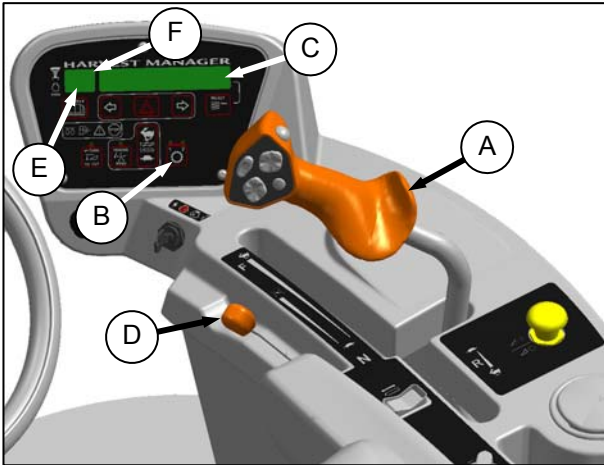

- Place GSL (A) in N-DETENT.
- Fasten seat belt.
- Start engine. Refer to Section 6.3.4.1 Starting.
- Set GROUND SPEED RANGE switch (B) to either:
  - 2 for road speed: 0 - 16 mph (25.7 km/h) or
  - 1 for field speed: 0 - 11 mph (17.7 km/h).CDM will display an engine status at (C).
- Slowly push throttle (D) to full forward (operating speed). CDM should display 2270 - 2330 RPM at (E).



### CAUTION

Check again to be sure all bystanders have cleared the area.

- Move the GSL (A) out of N-DETENT, and slowly move it forward to desired speed which will be displayed at (F).



### CAUTION

Operate both steering wheel and ground speed lever slowly for familiarization. Avoid the common tendency of new Operators to over-steer.

### NOTE

The windrower can be equipped with an automatic steering system for use in the field. The Auto-Steer is available as an option, and can be installed by an Auto-Steer Dealer. The GSL has been pre-wired at the factory with a switch. Also see Section 9.14 AUTO-STEER.

## 6.3.5.2.1 Reverse



### WARNING

Back up slowly. Steering is opposite to normal when reversing. Hold steering wheel at the bottom, and turn wheel in direction you want the rear of the machine to travel.

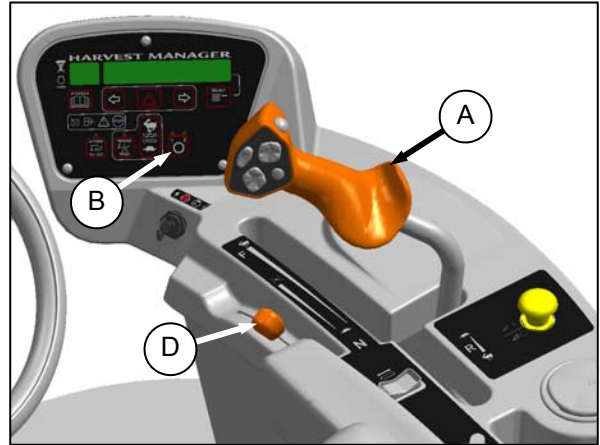

- Set ground speed-range switch (B) to 1 (field speed).
- Move throttle lever (D) to a mid-range position.

### NOTE

Reversing in low speed-range and at reduced engine speed is recommended since steering will be less sensitive than at higher speed settings.



### CAUTION

Check again to be sure all bystanders have cleared the area.

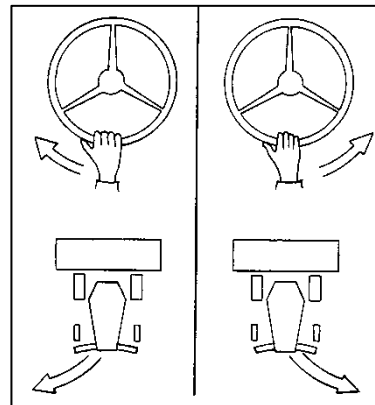

- Move the GSL (A) rearward to desired speed. Steer as shown.

## WINDROWER OPERATION

### 6.3.5.3 Spin Turn

Hydrostatic steering gives the Operator significantly more manoeuvrability than mechanical steering.



#### CAUTION

Be sure area is clear before making turns. Although windrower pivots on the spot, the ends of header travel faster, and in a large arc.

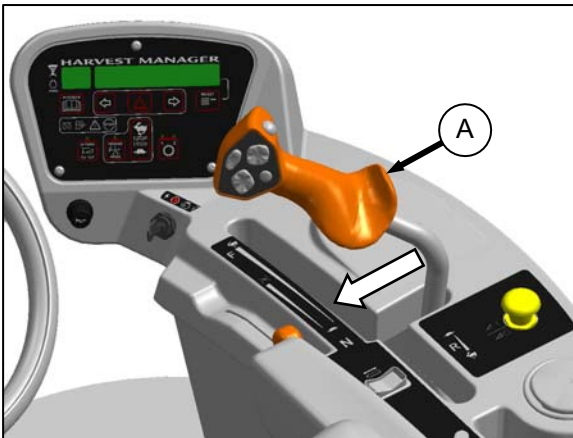

- Move the GSL (A) out of N-DETENT towards the seat, and hold.
- Slowly turn the steering wheel in the desired direction of turn. The windrower will pivot between the drive wheels.
- To stop the turn, slowly turn the steering wheel back to its centered position.
- To increase the turn radius, slowly move the GSL away from NEUTRAL. Remember that this will increase ground speed as well.
- To stop the turn, return the steering wheel to center.

### 6.3.5.4 Stopping



#### WARNING

Do not move ground speed lever rapidly back to NEUTRAL. Operator may be thrown forward by sudden stop. Always wear seat belt when operating windrower.

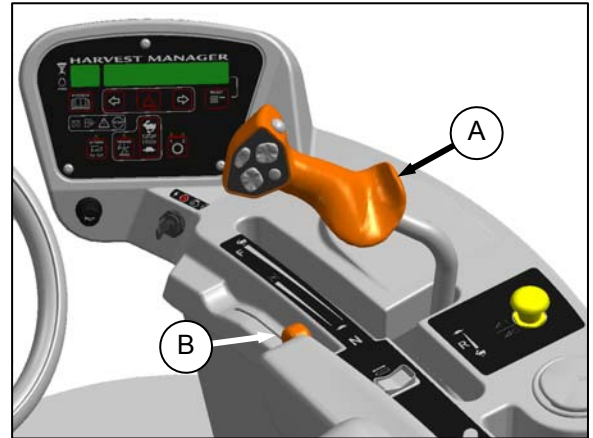

- SLOWLY return the GSL (A) to NEUTRAL, and into N-DETENT.
- Turn steering wheel until it locks.
- Move throttle lever (B) to low idle.

#### NOTE

*Avoid unnecessary idling. Stop engine if it will be idling for longer than 5 minutes.*

- Brakes are automatically engaged when steering wheel is locked in NEUTRAL.



#### CAUTION

**Park on a flat, level surface, header on the ground and the ground speed lever in N-DETENT and steering wheel locked.**

#### IMPORTANT

Before stopping engine, run at low idle for approximately five minutes to cool hot engine parts.

- Turn ignition key counter clockwise to OFF.

## WINDROWER OPERATION

### 6.3.6 Adjustable Caster Tread Width

The rear casters can be adjusted to a narrow tread width to allow loading and shipping without having to remove them.

A narrow tread width also suits smaller headers by allowing more space to the uncut crop, and provides more maneuverability around poles, irrigation inlets, or other obstacles.

A wider tread width is useful in heavy crops that produce large windrows so that runover is reduced.

Adjust the caster tread width as follows:



#### CAUTION

Park on a flat, level surface, header on the ground, the ground speed lever in N-DETENT, and steering wheel locked.



#### DANGER

Stop engine, and remove key from ignition before leaving Operator's seat for any reason. A child or even a pet could engage an idling machine.

- a. Raise rear of windrower slightly so that most of the weight is off the casters, using a jack or other lifting device under the frame where shown.

#### NOTE

Lifting device should have a lifting capacity of at least 5000 lb (2270 kg).

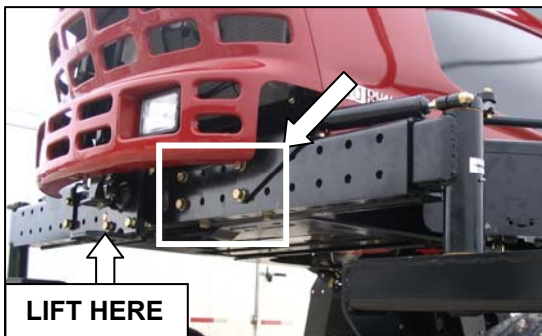

- b. Remove six bolts (four on backside, two on underside), and washers from left and right side of walking beam.

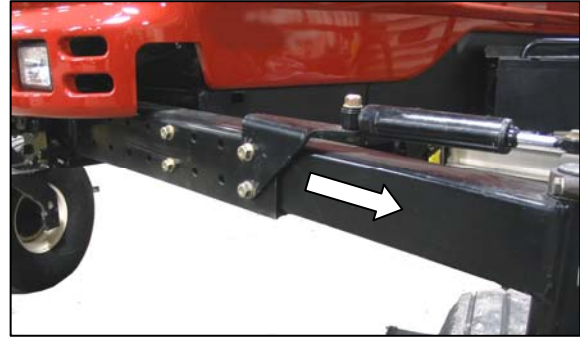

- c. Slide extensions inboard or outboard equal amounts, and align holes at desired location.

#### NOTE

Use the caster wheels to assist in moving the axle by rotating the caster so that wheel is parallel to the axle.

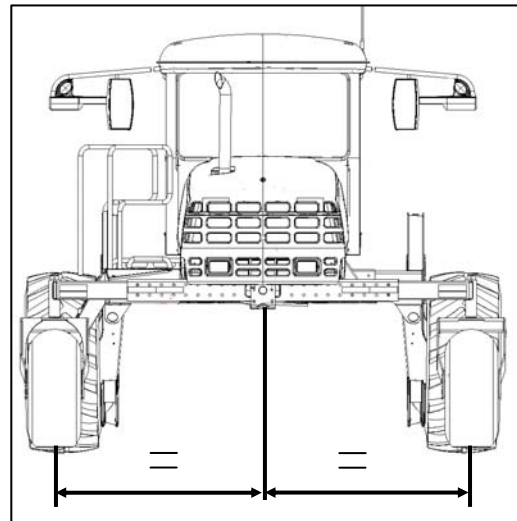

WIDEST TREAD WIDTH SHOWN

#### IMPORTANT

Caster wheels must be equi-distant from center of windrower.

(continued next page)

## WINDROWER OPERATION

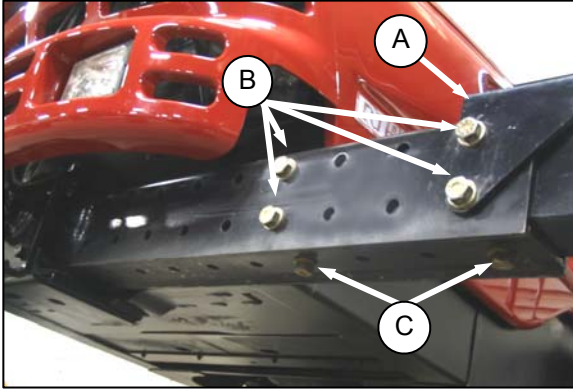

- d. Position bracket (A), and install bolts (B). The two shorter bolts are installed at the back inboard locations.
- e. Install bottom bolts (C).
- f. Tighten bolts as follows:
  1. Snug bottom bolts (C).
  2. Tighten and torque back bolts (B) to 330 ft·lbf (447 N·m).
  3. Tighten and torque bottom bolts (C) to 330 ft·lbf (447 N·m).
- g. Lower windrower to ground.

### **IMPORTANT**

Re-torque bolts after first 5, and 10 hours of operation.

## WINDROWER OPERATION

### 6.3.7 Transporting

#### 6.3.7.1 Driving On Road



### WARNING

Collision between windrower and other vehicles may result in injury or death.



### WARNING

When driving windrower on public roadways:

- Obey all highway traffic regulations in your area. Use pilot vehicles at front and rear of windrower if required by law.
- Use Slow Moving Vehicle (SMV) emblem and flashing warning lights unless prohibited by law.
- If width of attached header impedes other vehicle traffic, remove header, and install a MacDon approved weight box.



### CAUTION

Check local laws for width regulations and lighting and marking requirements before transporting on roads.



### WARNING

Do not drive windrower on a road or highway at night, or in conditions which reduce visibility, such as fog or rain. The width of the windrower may not be apparent under these conditions.



### CAUTION

Operate both steering wheel and ground speed lever slowly for familiarization.

Remember that steering is more sensitive when speed-range control is in mode 1 - ROAD.

Avoid the common tendency of new Operators to over-steer.



- a. Ensure HEADER DRIVE switch is pushed to OFF.
- b. Before driving windrower on a roadway:
  1. Clean flashing amber lamps, red tail lamp, and head lamps, and check that they work properly.
  2. Clean all reflective surfaces and slow moving vehicle (SMV) emblems.
  3. Adjust interior rear view mirror, and clean windows.



- c. Push LIGHT switch to ROAD to activate lamps.
- d. Use HIGH / LOW LIGHTS as required when other vehicles are approaching.



### WARNING

Always use these lamps on roads to provide warning to other vehicles. Do not use field lamps on roads, other drivers may be confused by them.

- e. Push BEACON switch to ON to activate beacons (North America optional).

*(continued next page)*



## WINDROWER OPERATION

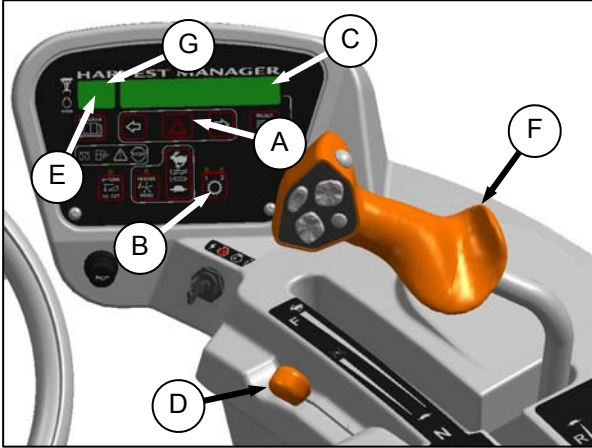

- With header removed, steering control is reduced if weight is not added to drive wheels.

If you must drive the windrower without header or MacDon weight system:

- Operate in low speed range.
- Do not exceed 1500 rpm engine speed.
- Avoid loose gravel and slopes.
- Do not tow a header.
- If control of machine is lost, immediately pull ground speed lever to NEUTRAL.

- f. Press switch (A) on CDM to activate hazard lights (Export optional).
- g. Set ground speed range switch (B) for road speed. CDM will display ROAD GEAR at (C).

### NOTE

*Windrower can be moving, but speed must be less than 5 mph (8 km/h) for road gear to engage.*

- h. Slowly push throttle (D) to full forward (operating speed). CDM should display 2270 - 2330 RPM at (E).
- i. Slowly move the GSL (F) forward to desired speed which will be displayed at (G).
- j. If towing a header, refer to Section 6.3.7.2 Towing Header with Windrower.



### WARNING

To avoid serious injury or death from loss of control:

- Do not make abrupt changes in steering direction.
- Anticipate turns and steep slopes by slowing down well in advance.
- Do not rapidly accelerate or decelerate while turning.
- When travelling on steep slopes:
  - i) Move ground speed lever closer to NEUTRAL to reduce speed.
  - ii) Lower header.
  - iii) Move GROUND SPEED RANGE switch to low range.

## WINDROWER OPERATION

### 6.3.7.2 Towing Header with Windrower



The windrower can be used to tow a MacDon Harvest Header with the Slow Speed Transport option installed, provided the Weight Box option is installed on the windrower, or an approved header transporter with weight transfer to the lift arms.



### WARNING

#### Harvest Header with Transport Option

The windrower without the header must not be used to tow headers due to reduced traction and possible loss of control unless the Weight Box option is installed on the windrower.



### CAUTION

- To tow a header for transporting with a M105 Self Propelled Windrower, the header must be equipped with the appropriate equipment to comply with all local regulations.
- Before each towing trip, a pre-trip inspection must be conducted to verify that all signal lighting and safety equipment is installed and functioning properly.
- Do not connect any towed implement except for:
  - 30 - 35 FT D-Series headers equipped with slow-speed transport package or,
  - Header transport trailers for 20 - 25 FT D-Series headers.
- Tongue weight must not exceed 500 lbs.
- Do not exceed the specified Combined Gross Vehicle Weight (CGVW).

- To prevent machine damage and/or loss of control, it is essential that the machine be equipped such that weights are within the following limits:

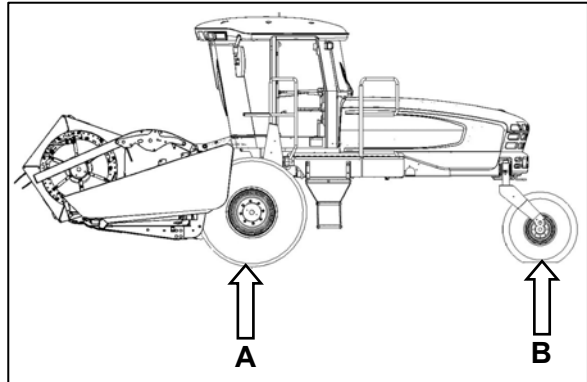

		LB	KG
<b>MAX GVW</b> (includes mounted implements).		17,750	8,050
<b>MAX CGVW</b> (includes towed and mounted implements).		20,200	9,160
<b>WEIGHT "A" ON BOTH DRIVE WHEELS.</b>	<b>MAXIMUM</b>	16,300	7,390
	<b>MINIMUM</b>	9,150	4,150
<b>MAX WEIGHT "B" ON BOTH CASTER TIRES.</b>		3,550	1,610

## WINDROWER OPERATION

### 6.3.7.2.1 From Field to Transport Mode

- a. Set header on the ground.



### DANGER

**Stop engine, and remove key from ignition before leaving Operator's seat for any reason. A child or even a pet could engage an idling machine.**

- b. Disconnect hydraulic and electrical connections:
- Left Side** - Store hydraulic hoses and electrical cable on holder on windrower. See Header Operator's Manual.
  - Right Side** - Release the multi-link, and place into holder on windrower. See Header Operator's Manual.

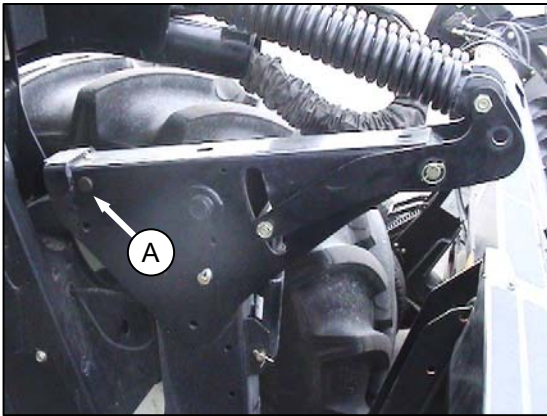

- c. Retrieve temporary lift pin from storage location on weight box, and install into rear hole (A) at the top of the lift arms for additional lift height for transport wheel deployment.



### DANGER

**To avoid bodily injury from fall of raised header, always engage header lift cylinder stops when working on or around raised header.**

- d. Raise header to full height, stop engine, and engage safety locks on lift cylinders.



- e. Deploy header slow speed transport system. See Header Operator's Manual.

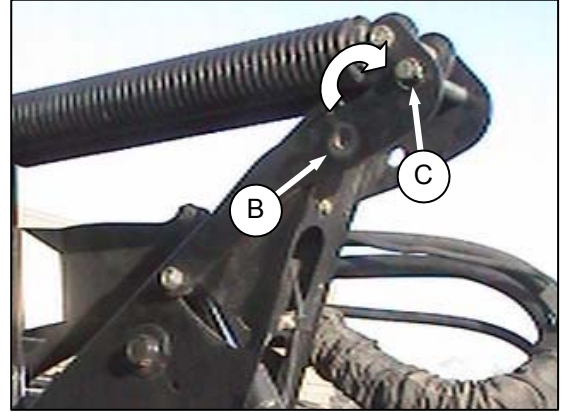

- f. Remove float pin from engaged location (B), and insert in storage location (C). Secure with lynch pin.

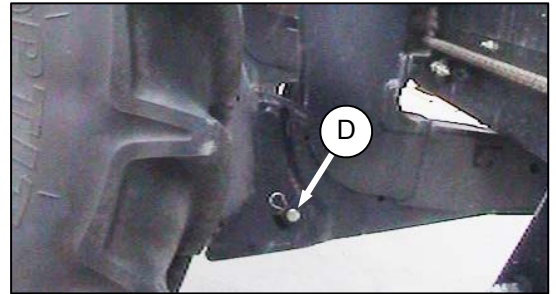

- g. Remove pins (D) from lower end of lift linkages.

#### NOTE

*Pins (D) are also used to secure weight box to windrower linkage.*

- h. Disconnect the center-link as follows:

### HYDRAULIC LINK - OPTIONAL

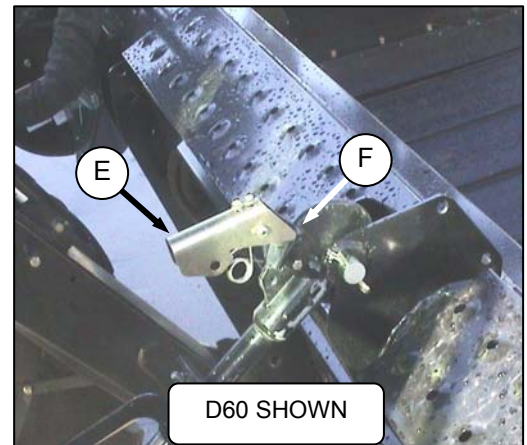

1. Pull up on latch (E), and locate latch into notch (F) on top of hook.

*(continued next page)*

## WINDROWER OPERATION

2. Release safety lock on the header lift cylinders.
3. Lower header down onto the transport wheels.
4. Disengage top link from the header. If necessary, use the HEADER TILT switch to release load on the cylinder.

1. Drive windrower so that windrower lift arms are located in the weight box pockets.
2. Raise lift arms slightly.
3. Stop engine, and remove key.

### MECHANICAL LINK

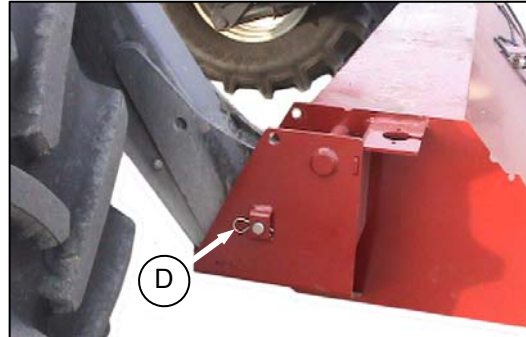
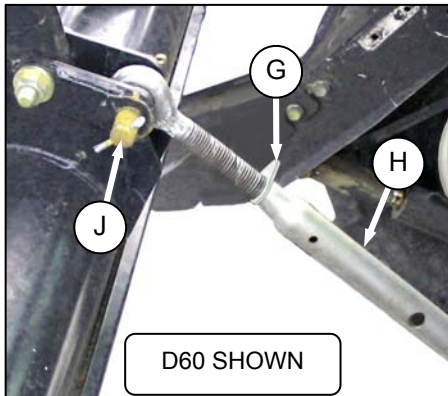

4. Install locking pins (D) into pockets and through windrower header lift linkages. Secure with hairpin.

#### **NOTE**

*Pins (D) were previously removed from the header lift linkage lower end.*

1. Loosen nut (G), and rotate barrel (H) to relieve load on link.
  2. Remove cotter pin on pin (J), and remove pin to disconnect from windrower. Re-install pin in header.
- i. Back windrower away from header.
  - j. Remove tow-bar sections from storage locations on header, assemble, and attach to header. See Header Operator's Manual.
  - k. Attach weight box to windrower as follows:

- l. At rear of windrower, lower the drawbar bracket as follows:

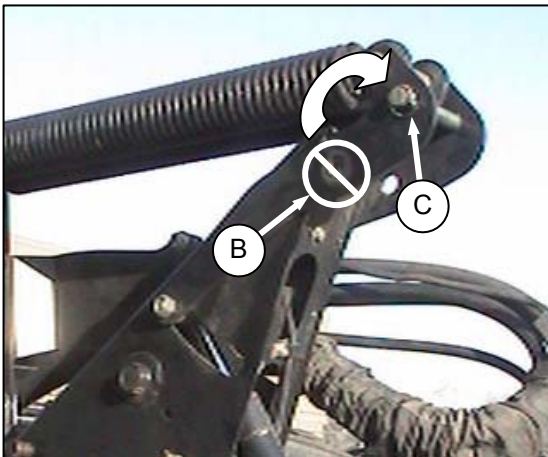

#### **IMPORTANT**

To prevent damage to the lift system when lowering header lift linkages without a header or weight box attached to windrower, ensure that float engagement pin is installed in storage location (C), and not installed at hole location (B).

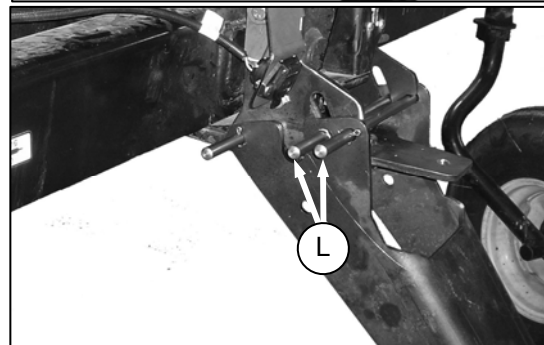
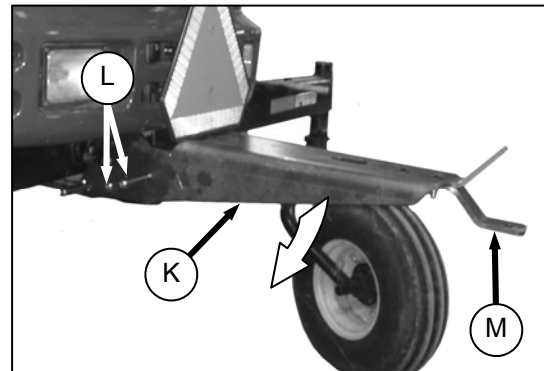

1. Hold drawbar support (K), and remove the two pins (L) at the forward end.
2. Lower support to position shown, and re-install the two pins (L) in uppermost pair of holes in support.
3. Alternate drawbar (M) can be removed if desired.

*(continued next page)*

## WINDROWER OPERATION

m. Attach tow-bar to windrower.

The M105 transport drawbar provides approximately 12 in. (300 mm) of fore-aft movement to ease the attachment of a towed implement.

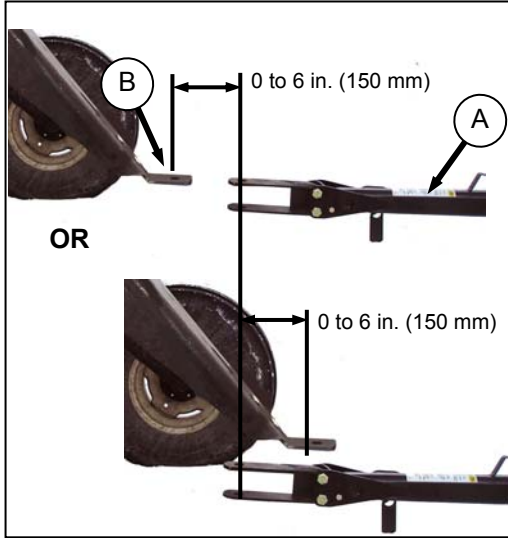

1. Back the windrower up to the tow-bar (A) so that drawbar hole (B) is within 6 in. (150 mm) of the tow-bar clevis pin.
2. Stop engine, and remove key.

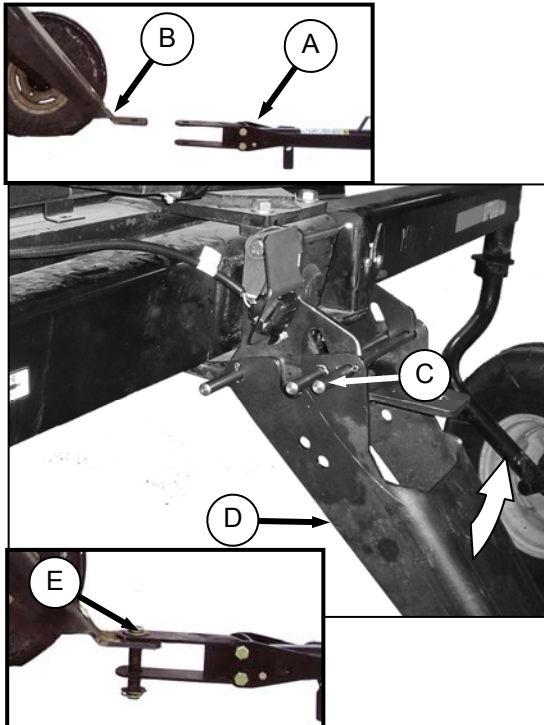

3. If the tow-bar (A) is **too far** from the drawbar (B):
  - i. Remove pin (C), lift the drawbar support (D) until the tow-bar clevis aligns, and then install the drawbar pin (E).
  - ii. Start engine, and gently reverse the windrower until the drawbar support pivots down to transport position.
  - iii. Stop engine, and remove key.
  - iv. Re-install pin (C) to secure drawbar support, and proceed to step n. (on next page).

### IMPORTANT

Ensure lynch pins are secure in all three pins, and that the drawbar pin is also secured by a locking pin.

4. If the tow-bar (A) is **too close** to the windrower:
  - i. Remove pin (F), lower the drawbar support (D) until the tow-bar clevis aligns, and then install the drawbar pin (E).
  - ii. Start engine, and gently drive the windrower forward until the drawbar support pivots up to transport position.
  - iii. Stop engine, and remove key.
  - iv. Re-install pin (F).

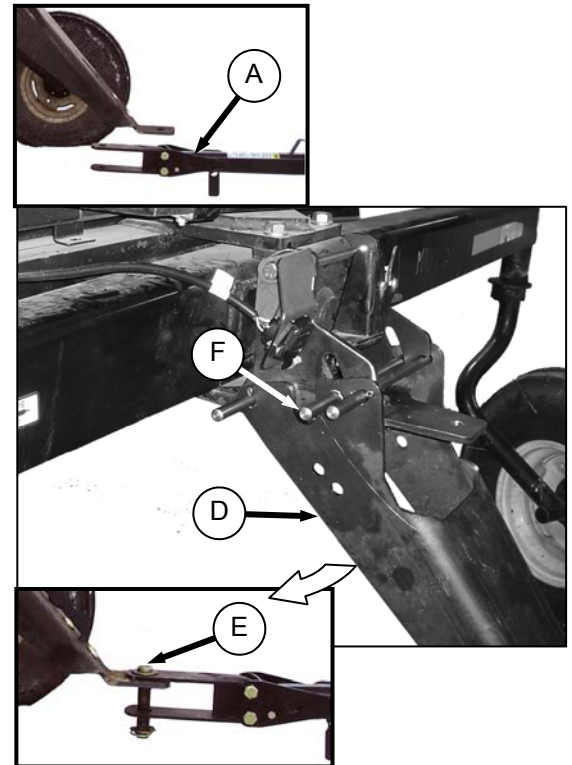

- i. Remove pin (F), lower the drawbar support (D) until the tow-bar clevis aligns, and then install the drawbar pin (E).
- ii. Start engine, and gently drive the windrower forward until the drawbar support pivots up to transport position.
- iii. Stop engine, and remove key.
- iv. Re-install pin (F).

*(continued next page)*

## WINDROWER OPERATION

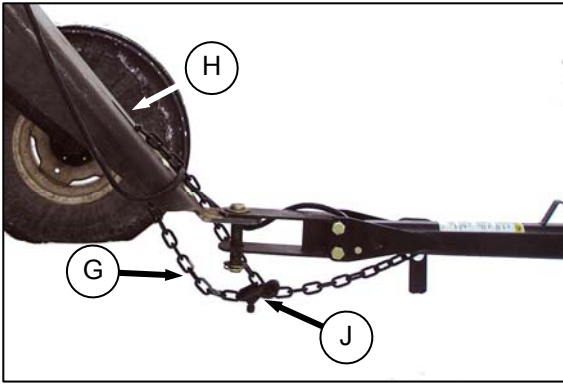

- r. Before moving the machine: double check that all pins are secure, the drawbar and hitching components are not showing signs of damage, and that all safety equipment is installed and fully functional.

- n. Connect safety chain (G) through the slot (H) in drawbar support, and securely attach the hook (J) to the chain. Leave enough slack to allow the hitch to pivot.

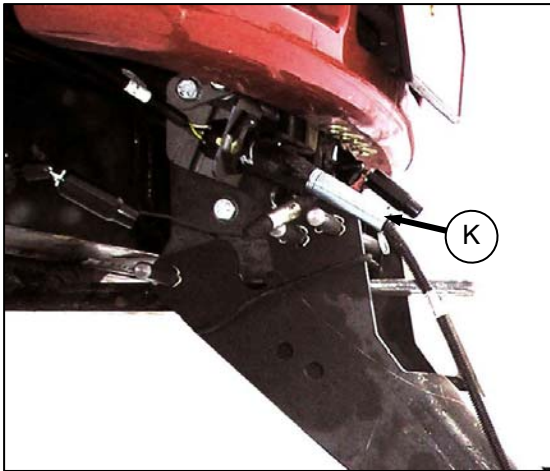

- o. At the drawbar, connect the tow-bar harness plug (K) to the receptacle on the windrower.

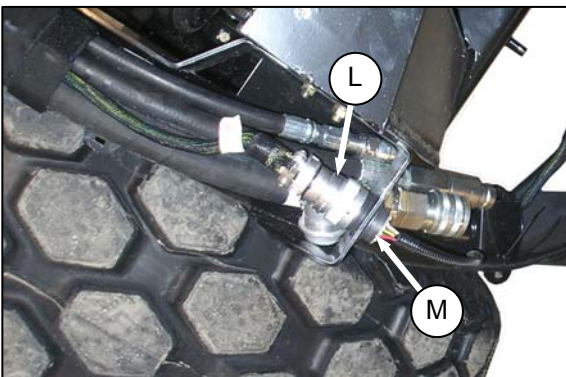

- p. At the LH float spring tower, attach connector (L) on windrower harness to towing harness receptacle (M).
- q. Confirm that the flashing amber and signal lights on header function properly.

## WINDROWER OPERATION

### 6.3.7.2.2 From Transport Mode To Field Operation



### DANGER

Stop engine, and remove key from ignition before leaving Operator's seat for any reason. A child or even a pet could engage an idling machine.

- a. Shut down windrower, and remove key.

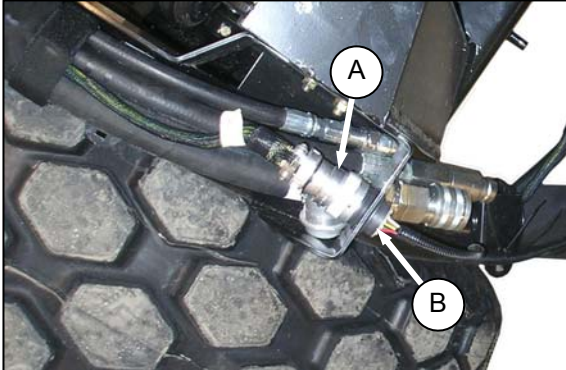

- b. Disconnect windrower harness (A) from towing harness receptacle (B) in LH float spring tower.

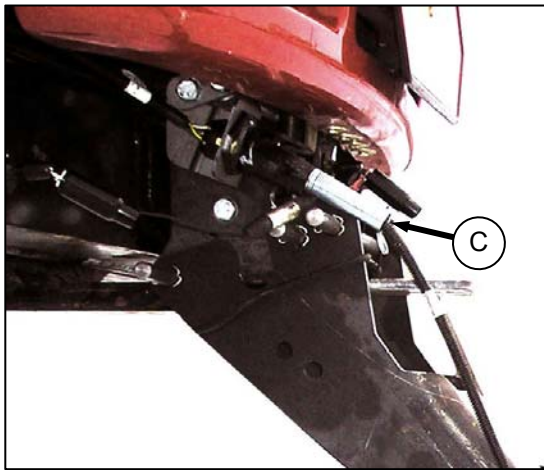

- c. Disconnect electrical harness (C) from windrower, and store harness on tow-bar.

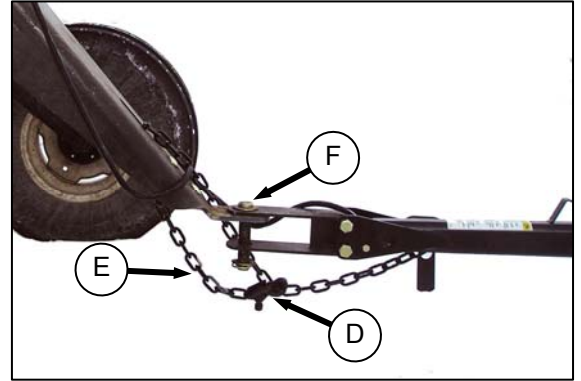

- d. Undo lock (D), remove safety chain (E) from drawbar, and remove clevis pin (F).
- e. Move tow-bar off drawbar.

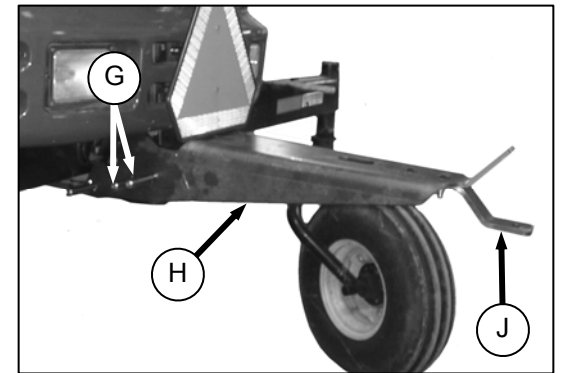
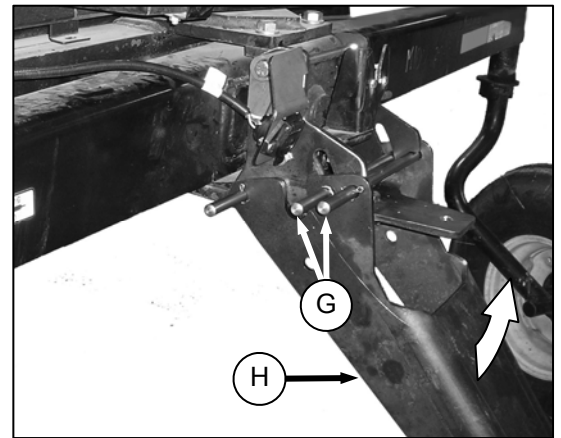

- f. At rear of windrower, remove pins (G), lift drawbar support (H) to horizontal position, and re-install pins (G) as shown.
- g. Alternate drawbar (J) is used for attaching a tow- behind swath roller.

### IMPORTANT

Do not use alternate drawbar for any other purpose.

- h. Disassemble tow-bar, and store on header. See Header Operator's Manual.

*(continued next page)*

## WINDROWER OPERATION

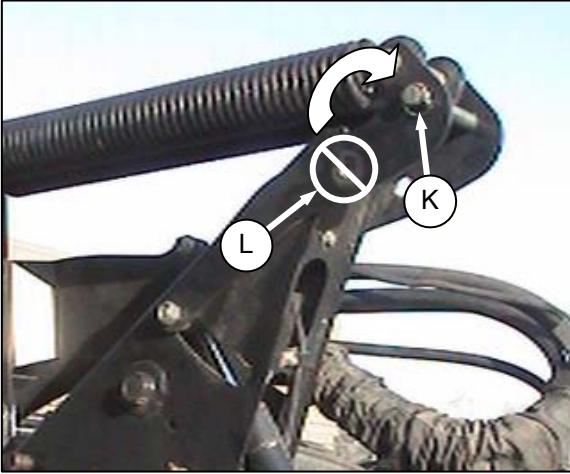

### IMPORTANT

To prevent damage to the lift system when lowering header lift linkages without a header or weight box attached to windrower, ensure that float engagement pin is installed in storage location (K), and not installed at hole location (L).

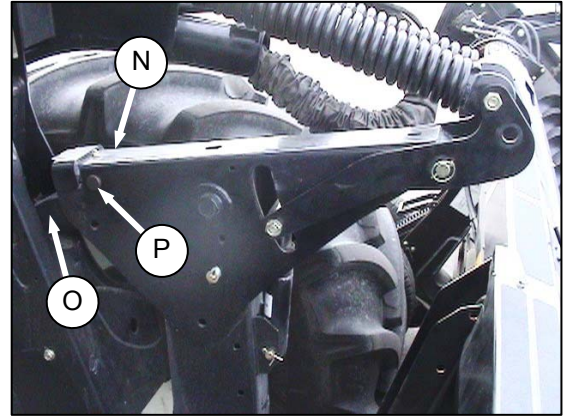
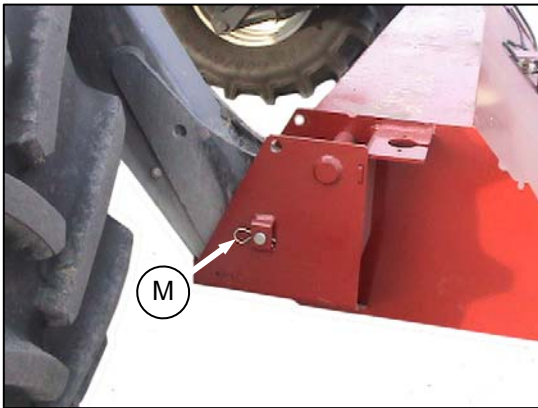

- m. Start engine, and lower header to ground. Continue to retract lift cylinders so that member (N) lifts off link (O).
- n. Remove temporary lift pins (P) from lift arms, and install pins into storage holes in weight box.
- o. Before operating the machine, double check that all pins are secure, and that all safety equipment is installed and fully functional.
- p. Proceed with operation of header.

- i. Remove pins (M) securing lift linkages to weight box, and retain pins for attaching header to windrower.
- j. Start engine, lower weight box onto blocks, and back away.
- k. Attach header to windrower. Refer to Section 6.5.3 *Header Attachment*.
- l. Convert header to field position. See Header Operator's Manual for procedure.



## WINDROWER OPERATION

### 6.3.8 Towing the Windrower

In emergency situations (for example, towing out of a field or into a shop), windrower may be towed without a trailer, providing the following precautions are followed:



#### WARNING

A proper towing apparatus is critical to safe towing. Use the following guidelines:

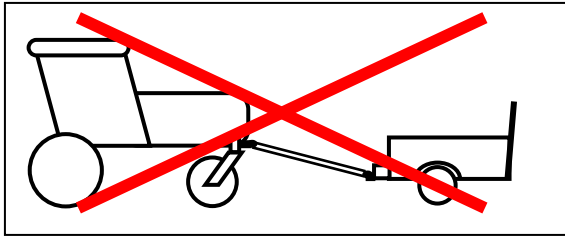

- Do not attach directly from hitch to walking beam. Slope of tow bar will not provide proper transfer of braking force to windrower, causing loss of control.

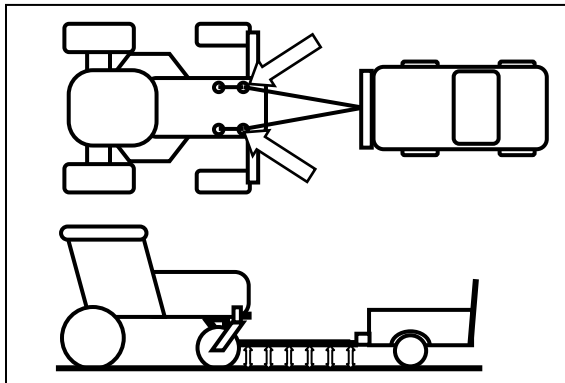

- For proper steering, towing apparatus should be attached to both left and right hand frame members, and should attach to tow bar at same height as towing vehicle hitch.
- Towing apparatus should be removed for field operation, to avoid interference with windrow.



#### WARNING

With final drives disengaged, the windrower may roll on a sloped surface. Before disengaging final drives, attach windrower to towing vehicle. After towing, engage drives, and ensure GSL is in N-DETENT before detaching from towing vehicle.

#### IMPORTANT

Failure to disengage final drives before towing will result in serious transmission damage.

#### IMPORTANT

Do not exceed 16 mph (26 km/h) when towing windrower.

#### IMPORTANT

Do not use this towing method for normal transporting of windrower.

#### IMPORTANT

Even with final drives disengaged, rolling speeds of more than 16 mph (26 km/h) will cause final drive gears to run at excessive speeds, possibly severely damaging or causing the unit to fail.

### 6.3.8.1 Final Drives

Disengage and engage final drives as follows:

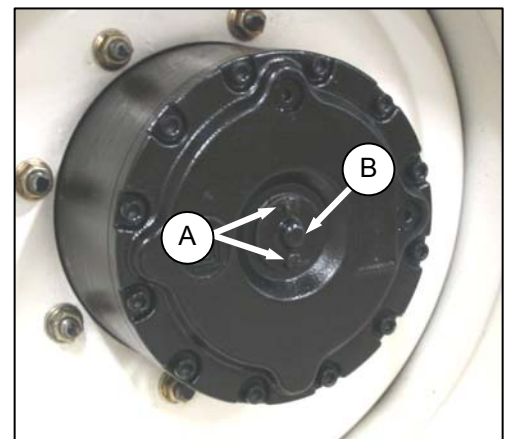

- Remove the two hex bolts (A) at center of drive wheel.
- Remove cap (B), and flip over so that dished side faces in. The cap depresses a pin that disengages the gearbox.
- After towing, reverse cover (A) to re-engage final drives. Be sure plunger at center of wheel pops out to engage drive.

## WINDROWER OPERATION

### 6.3.9 Storage

At the end of each operating season:

- a. Clean the windrower thoroughly.



#### WARNING

**Never use gasoline, naphtha or any volatile material for cleaning purposes. These materials are toxic and/can be flammable.**

- b. Store windrower in a dry protected place.



#### CAUTION

**Never operate engine in a closed building. Proper ventilation is required to avoid exhaust gas hazards.**

- c. Remove the battery. Refer to Section 7.10.1.5 Replacing Battery.
- d. Bring to full charge, and store in a cool, dry place not subject to freezing.



#### CAUTION

**Remember when working around storage batteries that all of the exposed metal parts are live. Never lay a metal object across the terminals because a spark and short circuit will result.**

- e. If stored outside, always cover windrower with a waterproof tarpaulin or other protective material. This will protect the switches, instruments, tires, etc. from inclement weather.
- f. If no cover is available; seal air cleaner intake and exhaust pipe with plastic bags and/or waterproof tape.
- g. If possible, block up windrower to take weight off tires. If it is not possible to block up the machine, increase tire pressure by 25% for storage. Adjust to recommended operating pressure before next use.
- h. Re-paint all worn or chipped painted surfaces to prevent rust.
- i. Lubricate the windrower thoroughly, leaving excess grease on fittings to keep moisture out of bearings. Apply grease to exposed threads and sliding surfaces of components.
- j. Check for worn components and repair. Tighten loose hardware, and replace any missing hardware. See Section 7.3.1 *Recommended Torques* for torque charts.

- k. Check for broken components, and order replacements from your MacDon Dealer. Attention to these items right away will save time and effort at beginning of next season.
- l. Add approved rust inhibitor to the engine oil in accordance with the manufacturer's instructions. Run engine to operating temperature to mix inhibitor with oil, unless otherwise specified.
- m. To prevent condensation, fill hydraulic oil reservoir to filler neck with approved hydraulic system oil. Refer to Section 7.11.1 *Oil Level*.
- n. Test engine coolant anti-freeze concentration to ensure it is sufficient to protect engine against lowest expected temperature.

## HEADER OPERATION - GENERAL

### 6.4 HEADER OPERATION

The M105 Windrower is designed to use the MacDon A-Series Auger Header, and D50 and D60 Series Rigid Draper Headers (up to 35 FT) with or without a Hay Conditioner.

This section describes the attachment and detachment procedures and operating instructions for these header types.

#### 6.4.1 Header Lift Cylinder Stops

Cylinder stops are located on both header lift cylinders on the windrower.

To avoid bodily injury or death from fall of raised header, always engage cylinder stops before going under header for any reason.

Engage cylinder stops as follows:

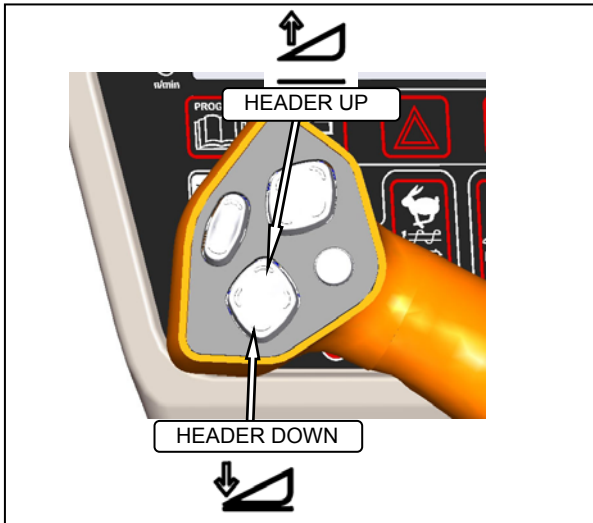

- Press HEADER UP switch to raise header to maximum height.

#### NOTE

*If one end of the header does not raise fully, the lift cylinders require re-phasing. Proceed as follows:*

- Press and hold HEADER UP switch until both cylinders stop moving.
- Continue to hold switch for 3 - 4 seconds.
- Cylinders are phased.

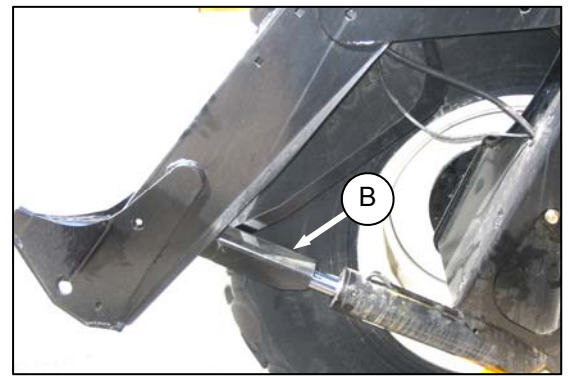
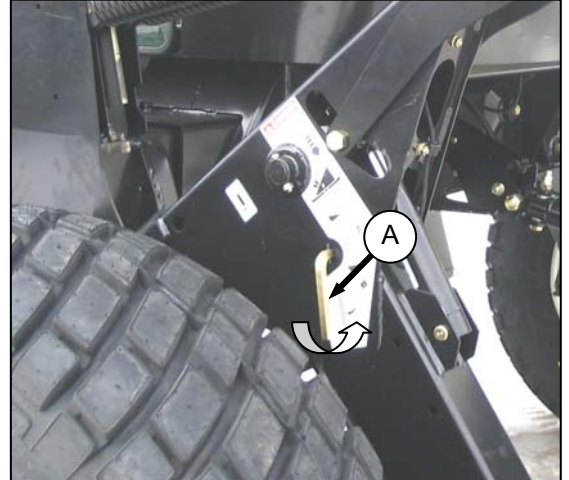

- Pull lever (A), and rotate toward header to release, and lower cylinder stop (B) onto cylinder. Repeat for both lift cylinders.
- To store, turn lever (A) away from header to raise cylinder stop until lever locks into vertical position.

## HEADER OPERATION - GENERAL

### 6.4.2 Header Flotation

Float is intended for cutting crops that require the cutterbar to be in contact with the ground.

Optimum float is for the cutterbar to maintain contact with the ground with minimum bouncing and scooping or pushing soil.

The machine will perform best with minimum extra weight on the header.

#### IMPORTANT

To avoid frequent breakage of sickle components, scooping soil, or soil build-up at cutterbar in wet conditions, header float should be set as light as possible without causing excessive bouncing.

When float setting is light, it may be necessary to use a slower ground speed to avoid excessive bouncing and leaving a ragged cut.

#### IMPORTANT

The stabilizer wheels are designed to minimize bouncing at the header ends, and not float the header. Refer to the D50 and D60 Harvest Headers for Self-Propelled Windrowers Operator's Manual (Form 169441) for adjustment details.

### 6.4.2.1 Float Operating Guidelines

When working with the cutterbar on the ground;

- Set center-link to mid-range. Refer to Section 6.4.5 *Header Angle*.
- In rocky fields, adjust skid shoes down to raise guards when operating at flattest header angle to minimize scooping rocks.
- Adjust header height or adjust header angle to minimize pushing soil.

### 6.4.2.2 Float Adjustment

The float adjustment uses drawbolts to change the tension on the springs in the lift linkages.

- a. Check header float as follows:



#### CAUTION

**Check to be sure all bystanders have cleared the area.**

1. Start engine.

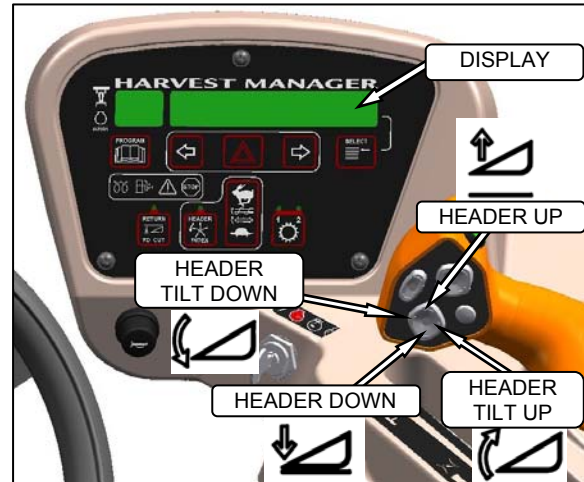

2. If hydraulic center-link is installed, use HEADER TILT switches to set center-link to mid-range (**05.0** on CDM display).
3. Using HEADER DOWN switch, lower header fully with lift cylinders fully retracted.



#### DANGER

**Stop engine, and remove key from ignition before leaving Operator's seat for any reason. A child or even a pet could engage an idling machine.**

4. Shut down engine, and remove key.
5. Grasp the divider rod, and lift. The force to lift should be as noted in the following table (on next page), and should be approximately the same at both ends.

*(continued next page)*

## HEADER OPERATION - GENERAL

HEADER	FORCE TO LIFT CUTTERBAR AT ENDS WITH LIFT CYLINDER FULLY RETRACTED
Auger	75 - 85 lbf (335 - 380 N)
Draper	75 - 85 lbf (335 - 380 N) with Stabilizer/Transport Wheels raised (if equipped).

- b. If necessary, adjust the float with the drawbolts as follows:



### CAUTION

**Check to be sure all bystanders have cleared the area.**

1. Start engine.

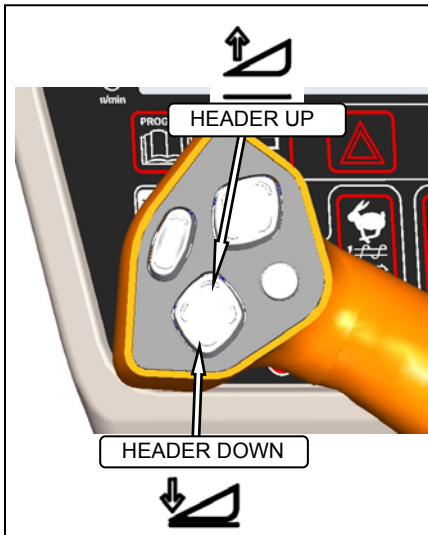

2. Using HEADER UP switch on GSL, Raise the header fully, shut down the engine, and remove the key.

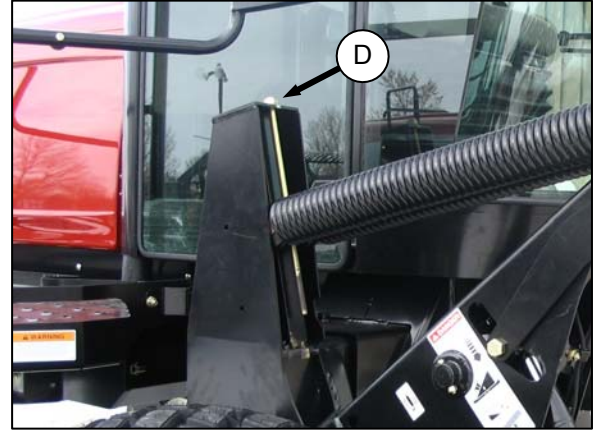

3. Turn drawbolt (D) clockwise to increase float (makes header lighter) or counter clockwise to decrease float (makes header heavier).
4. Re-check the float as described on previous page.

## HEADER OPERATION - GENERAL

### 6.4.3 Levelling

The windrower linkages are factory-set to provide the proper level for the header, and should not normally require adjustment.

If the header is not level, perform the following checks prior to adjusting the leveling linkages. The float springs are not used to level the header.

- Raise header to full height, and keep HEADER UP switch depressed to ensure lift cylinders are phased.
- Check drive wheel tire pressures.
- Check and set float adjustment. Refer to previous sections.
- If header is not level after the above checks, adjust as follows:

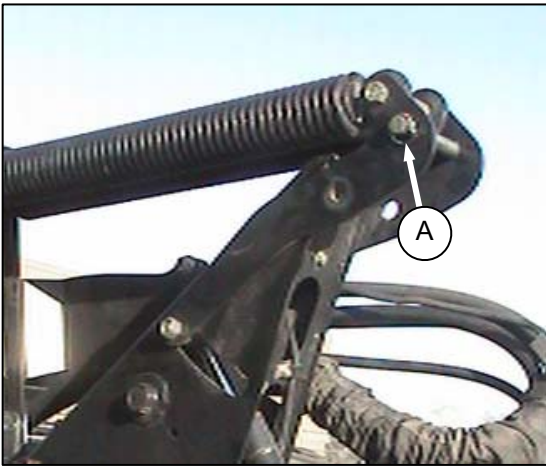

- Place float pins in storage location (A).
- Park windrower on level ground.

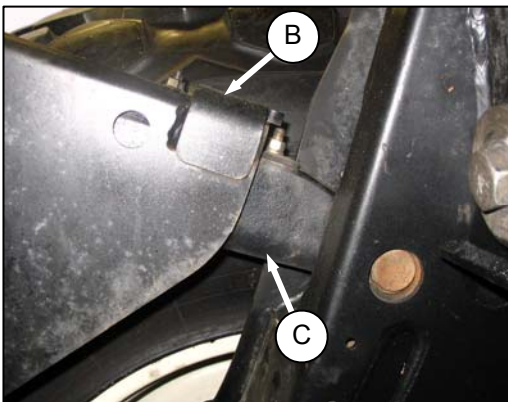

- Set header approximately 6 inches (150 mm) off ground, and check that member (B) is on link (C) as shown. Note high and low end of header.

- Place wooden blocks under header cutterbar and legs.

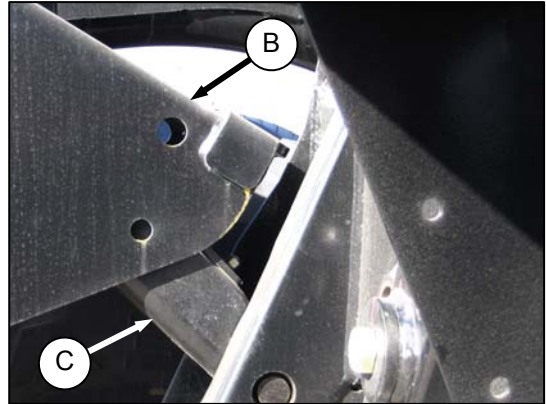

- Lower header onto blocks so that members (B) lift off links (C). Stop engine.



### DANGER

Stop engine, and remove key from ignition before leaving Operator's seat for any reason. A child or even a pet could engage an idling machine.

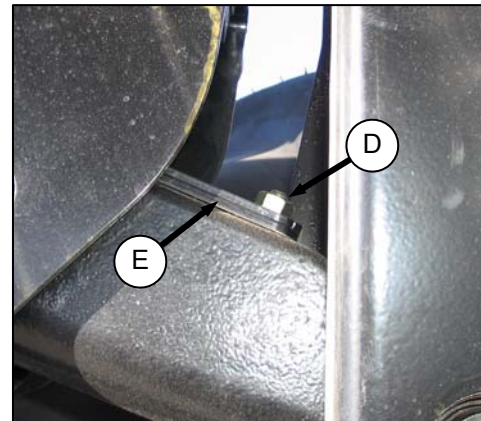

- On high side, remove nut, washer and bolt (D) that attaches shims (E) to link.
- Remove one or both shims (E), and re-install the hardware (D).



### CAUTION

Check to be sure all bystanders have cleared the area.

- Start engine, and raise header slightly. Check level of header.

*(continued next page)*

## HEADER OPERATION - GENERAL

- f. If additional levelling is required, install the removed shim on the opposite linkage.

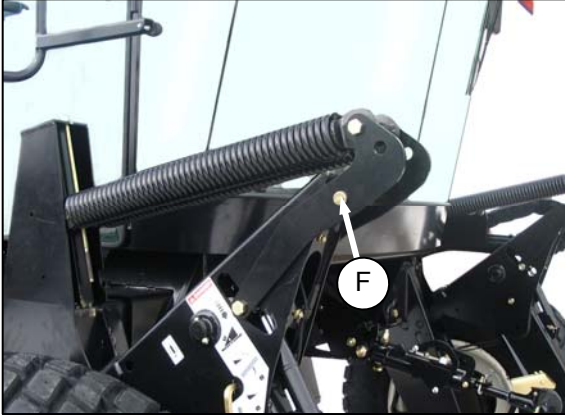

- g. Once header is level, return float pins to their engaged location (F).

### NOTE

*If required, additional shims are available from your MacDon Dealer*

### NOTE

*Float does not require adjustment after levelling header.*

### 6.4.4 Header Drive

The headers are hydraulically driven and controlled from the windrower with no mechanical drive shafts.

One hydraulic piston pump on the windrower provides fluid power to the knife, and three gear pumps power the drapers or auger, reel, lift and positioning systems and optional attachments.



### CAUTION

**Check to be sure all bystanders have cleared the area.**

### IMPORTANT

Always move throttle lever back to idle before engaging header drive. Do not engage header with engine at full RPM.

### To Engage Header:

- a. Move throttle to adjust engine speed to idle.



- b. Push down on the yellow knob, and pull up on the black ring at the base of the switch.  
c. A slight delay between switch ON and operating speed is normal.

### To Disengage Header:

- a. Push yellow knob.

### 6.4.5 Header Angle

Header angle is defined as the angle between the ground and the drapers/cutterbar, and is adjustable to accommodate crop conditions and/or soil type.

Refer to the appropriate Header Operator's Manual for range of adjustment and recommended settings for your particular header.

The header angle can be hydraulically adjusted from the cab without shutting down the windrower. A read-out on the CDM allows the Operator to establish settings for each crop condition. This feature requires that an optional module has been installed, either at the factory or at your MacDon Dealer.

### IMPORTANT

Changing header angle will affect flotation slightly because it has the effect of making the header lighter or heavier.

### IMPORTANT

To prevent excessive guard breakage when conditions are not suited to heavier float (e.g. rocky or wet), do not use the tilt control on the go. Instead, use the HEADER HEIGHT switch.

*(continued next page)*

## HEADER OPERATION - GENERAL

Change header angle as follows:

### HYDRAULIC CENTER-LINK (OPTIONAL)

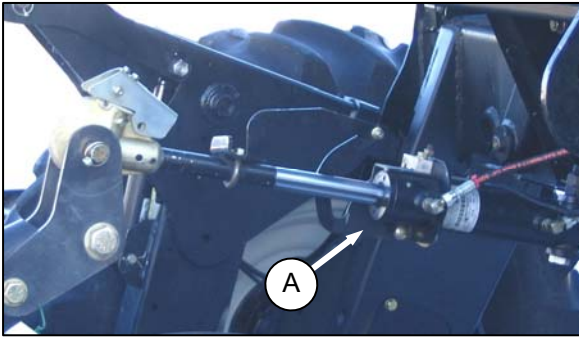
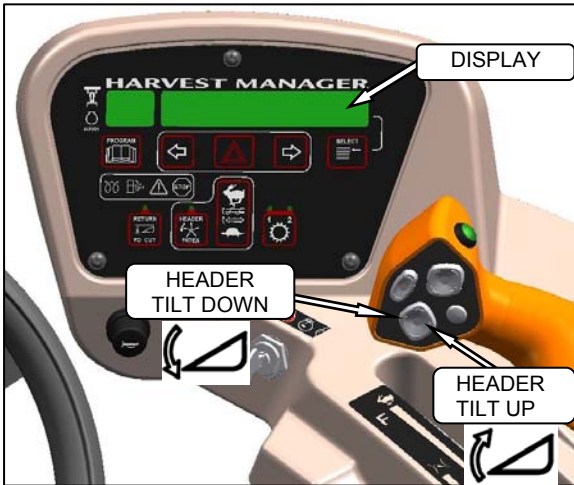

- To decrease (flatten) header angle, operate HEADER TILT UP switch on GSL handle so that cylinder (A) retracts. The CDM display will show a reading on the lower line of decreasing value between **00.0 and 10.0**.
- To increase (steepen) header angle, operate HEADER TILT DOWN switch on GSL handle so that cylinder (A) extends. The CDM display will show a reading on the lower line of increasing value between **00.0 and 10.0**.
- The HEADER TILT switch can be deactivated to prevent inadvertent header angle changes when pressing the header height control switches. Refer to paragraph 5.18.5 *Cab Display Module (CDM) Programming*.
  - Switch to PROGRAM mode on CDM.
  - Press SELECT until SET CONTROL LOCKS? is displayed.
  - Press to display HEADER TILT.
  - Press to LOCK (deactivate) the control.
  - Press PROGRAM to exit.

- Periodically check the operation of the hook locking mechanism, and ensure that it is working properly as follows:

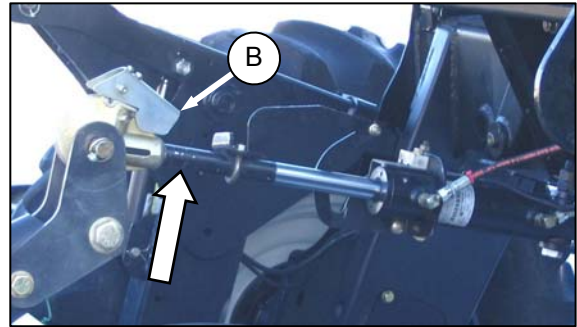

- If header is attached to windrower, disconnect center-link hook from header by pulling up on handle (B) to release the locking device, and then lifting the hook off the header pin.
- Lower the handle into the **lock** position.

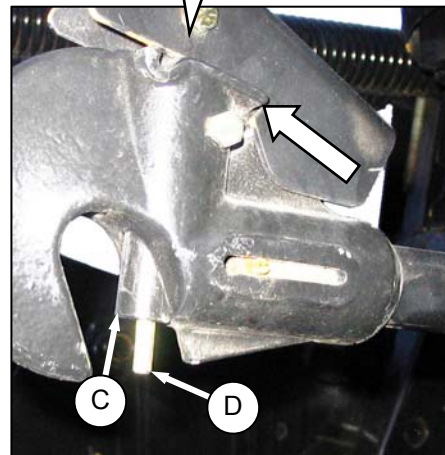
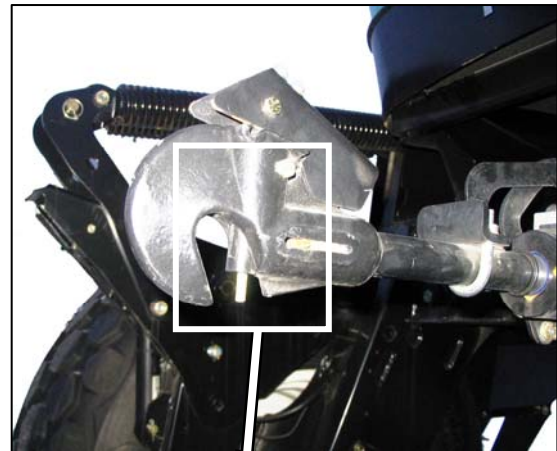

- Push up on pin (C) only. Handle should catch on casting, and pin should not lift.

(continued next page)



## HEADER OPERATION - GENERAL

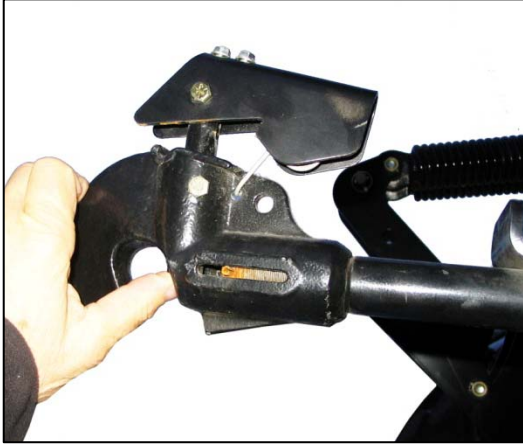

4. Push up on actuator rod (C), and pin should lift with the handle.

### 6.4.6 Cutting Height

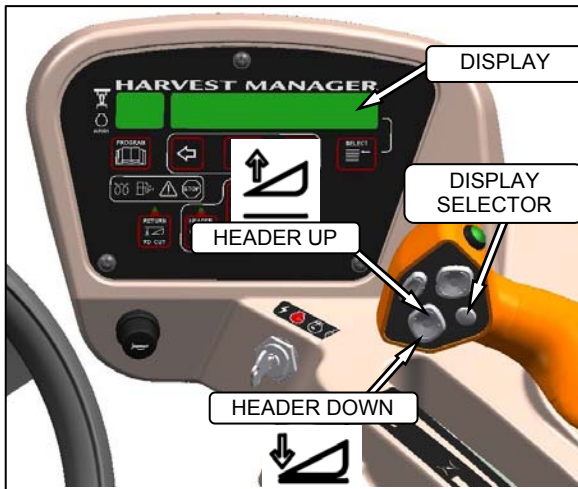

The header is raised or lowered with the HEADER UP or HEADER DOWN switches on the GSL. See illustration. The CDM indicates the header height by a reading on the DISPLAY lower line between **00.0** and **10.0**, with 00.0 being on the ground. Use DISPLAY SELECTOR switch to display the current setting.

### 6.4.6.1 Return To Cut (Optional)

The monitoring system assists the Operator in maintaining the desired cutting height with the optional RETURN TO CUT feature that can be turned OFF or ON with a switch on the CDM.

The RETURN TO CUT feature enables the Operator to have the header return to a pre-selected cutting height and angle.

If desired, the CDM can be programmed so that only the cutting height feature is active. The unit is pre-programmed to activate both cutting height and header angle.

- a. Program the RETURN TO CUT feature as follows:

#### IMPORTANT

The windrower must be running with the header engaged.

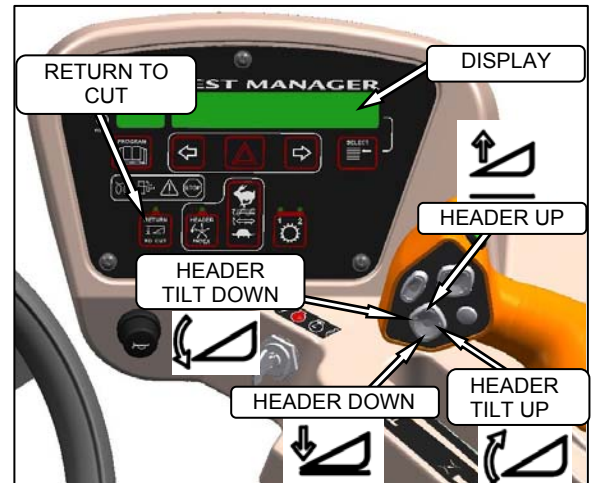

1. RETURN TO CUT switch must be OFF (indicator light is OFF).
2. Adjust the header to the desired height with the HEADER UP or HEADER DOWN switches on the GSL. CDM displays between **00.0** and **10.0**.
3. Adjust the header angle with the HEADER TILT UP or HEADER TILT DOWN switches on the GSL. CDM displays between **0.0** and **10.0**. This step is not required if height only has been pre-selected.
4. Press the RETURN TO CUT switch on the CDM. The indicator light will illuminate, and the settings are now programmed into the WCM.

*(continued next page)*

## HEADER OPERATION - GENERAL

- b. Use the RETURN TO CUT feature as follows:

### IMPORTANT

Ensure the header is engaged, and the RETURN TO CUT switch is illuminated.

### NOTE

The header can be raised or lowered at any time by **depressing and holding** the **HEADER UP** or **HEADER DOWN** switches on the GSL.

1. If header is above the pre-set height, **momentarily press** HEADER DOWN switch, and header will return to pre-set height.
2. If the header is below the pre-set height, **press and hold** the HEADER UP switch to raise the header. Release switch to stop header. Alarm will sound when header rises past the pre-set height.
3. If the header angle is changed, double click (two clicks within 0.5 seconds) the HEADER TILT UP or HEADER TILT DOWN switch, and the header will return to the pre-set angle.

### NOTE

If the header cannot return to the pre-set height or angle within 30 seconds, the RETURN TO CUT feature will deactivate to prevent the hydraulic oil from overheating. Push the RETURN TO CUT switch to reactivate.

### 6.4.6.2 Auto-Raise Height

- a. Program the AUTO RAISE HEIGHT feature as follows:

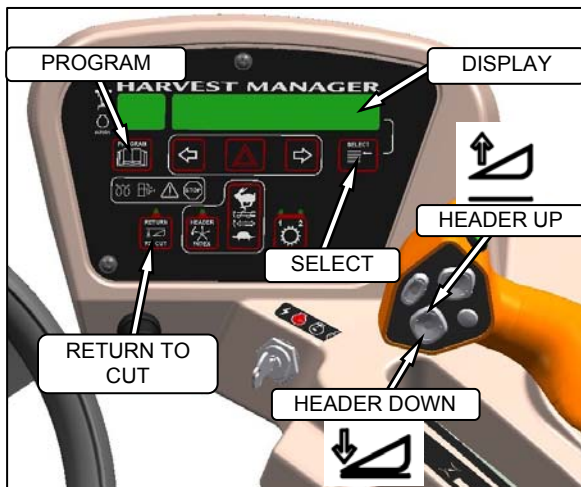

1. RETURN TO CUT switch can be OFF or ON.
2. PROGRAM and SELECT on CDM to enter Programming Mode.

3. Press SELECT. TRACTOR SETUP? is displayed on upper line.
4. Press  $\Rightarrow$ , then SELECT. SET KNIFE SPEED? is displayed.
5. Press SELECT until AUTO RAISE HEIGHT is displayed.
6. Press  $\leftarrow$  or  $\rightarrow$  to change value on lower line. Working range is 4.0 to 9.5, where 10.0 is fully raised and OFF.
7. Press PROGRAM to exit Programming Mode when finished entering desired values.

- b. Use the AUTO RAISE HEIGHT feature as follows:

### IMPORTANT

The windrower must be running with the header engaged at the cutting height, and the RETURN TO CUT switch activated.

1. Double click HEADER UP switch on the GSL to raise the header to the AUTO RAISE HEIGHT set point.

### NOTE

If HEADER UP is pressed while header is being raised, AUTO RAISE HEIGHT is temporarily disabled, and header will maintain current height.

2. Momentarily press the HEADER DOWN switch on the GSL to return the header to the pre-set cutting height.

### 6.4.7 Swath Roller Operation

Refer to the operating instructions that are provided with the Swath Roller kit.

## HEADER OPERATION - D SERIES

### 6.5 D SERIES HEADER OPERATION

#### 6.5.1 Configure Hydraulics

The M105 windrower must be fitted with a draper drive basic kit to operate the D-Series draper headers.

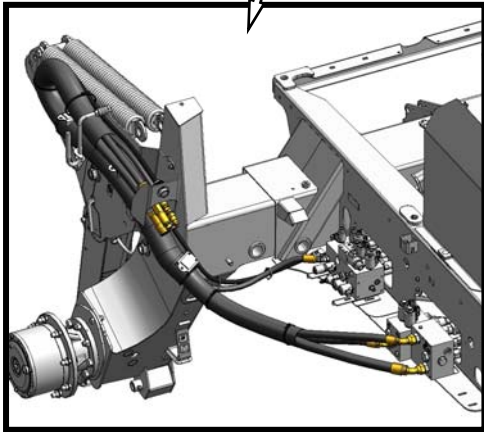

DRAPER HEADER DRIVE HYDRAULICS

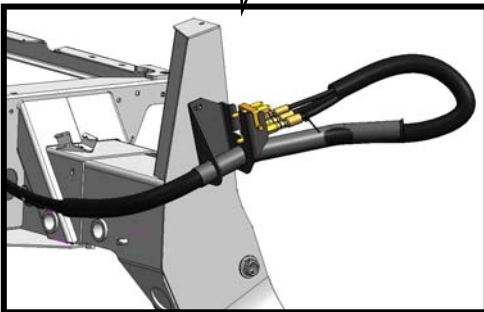

DRAPER HEADER REEL HYDRAULICS

Windrowers equipped with D-Series hydraulics have four header drive hoses on the LH side, and up to five reel drive hoses on the RH side.

If necessary, obtain Kit B5577 from your MacDon Dealer, and install it in accordance with the instructions supplied with the kit

#### 6.5.2 Attach Header Boots

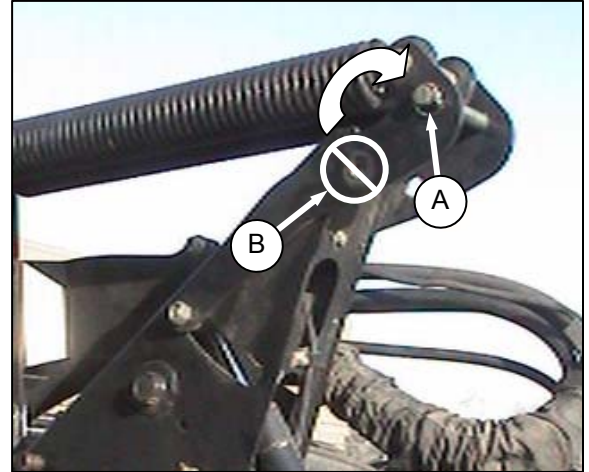

#### IMPORTANT

To prevent damage to the lift system when lowering header lift linkages without a header or weight box attached to windrower, ensure that float engagement pin is installed in storage location (A), and not installed at hole location (B).

If not installed, attach draper header boots (supplied with header) to windrower lift linkage as follows:

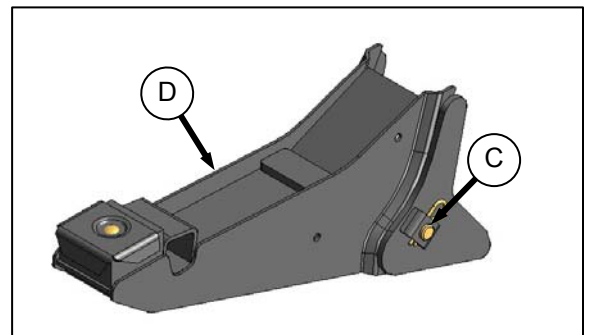

- a. Remove pin (C) from boot (D).

*(continued next page)*

## HEADER OPERATION - D SERIES

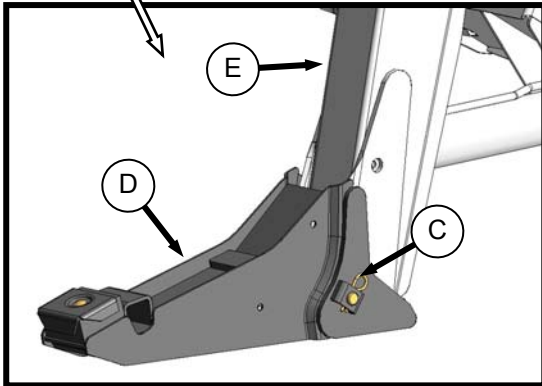

- b. Locate boot (D) on lift linkage (E), and re-install pin (C). Pin may be installed from either side of boot.
- c. Secure pin (C) with hairpin.
- d. Repeat for opposite side.

### 6.5.3 Header Attachment

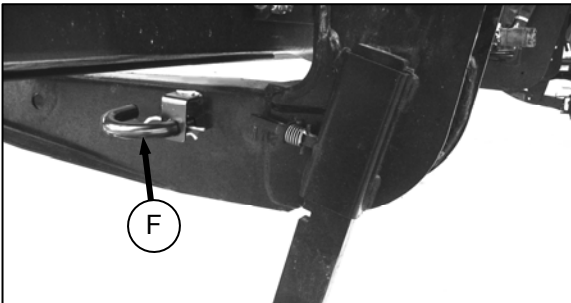

- a. Remove hairpin on pins (F), and remove pins from header legs.

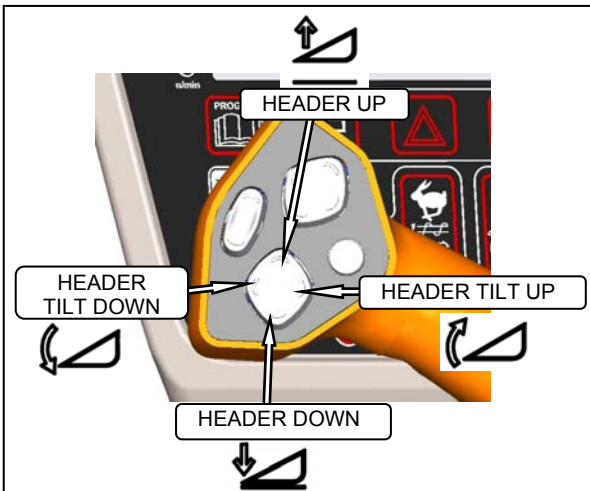

### IMPORTANT

For machines equipped with the hydraulic center-link, it may contact the header as the windrower approaches the header for hook-up.

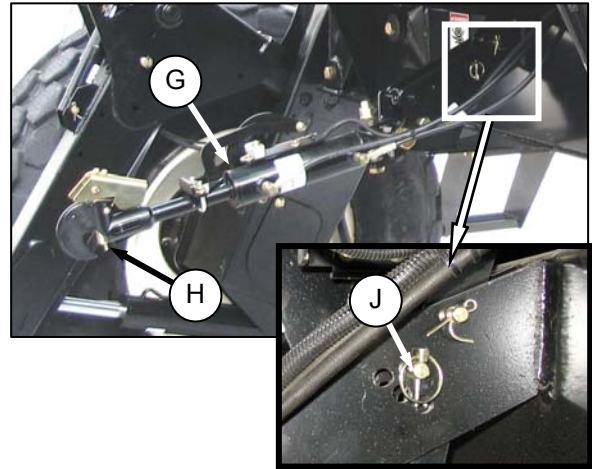

- b. If necessary, re-locate the pin (J) at the frame linkage as required to raise the center-link (G) so that the hook (H) is above the attachment pin on the header.



### CAUTION

**Check to be sure all bystanders have cleared the area.**

- c. Start engine, and activate HEADER DOWN button on the GSL to fully retract header lift cylinders.

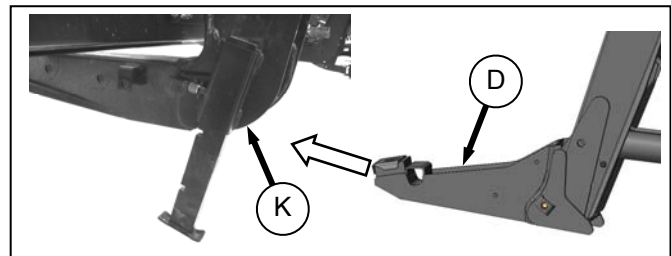

- d. Slowly drive windrower forward so that boots (D) enter header legs (K). Continue to drive slowly forward until lift linkages contact support plates in the header legs, and header nudges forward.
- e. Ensure that lift linkages are properly engaged in header legs, contacting support plates.

*(continued next page)*

## HEADER OPERATION - D SERIES

f. Connect center-link:

### HYDRAULIC LINK

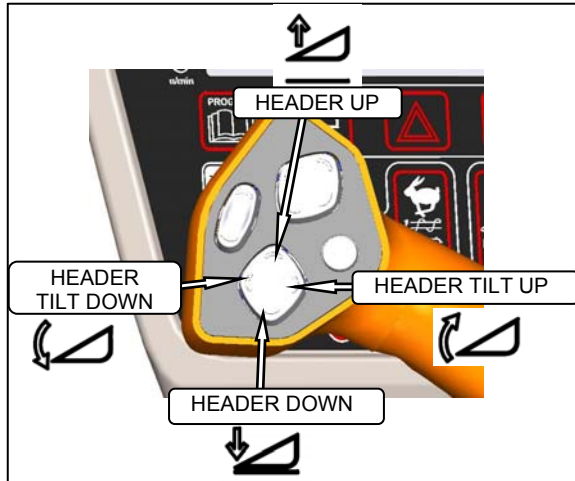

1. Activate HEADER TILT cylinder switches on GSL to extend or retract center-link cylinder (G) so that the hook lines-up with the header attachment pin.



### WARNING

Stop windrower engine, and remove key before making adjustments to machine. A child or even a pet could engage the drive.

2. Stop engine, and remove key from ignition.

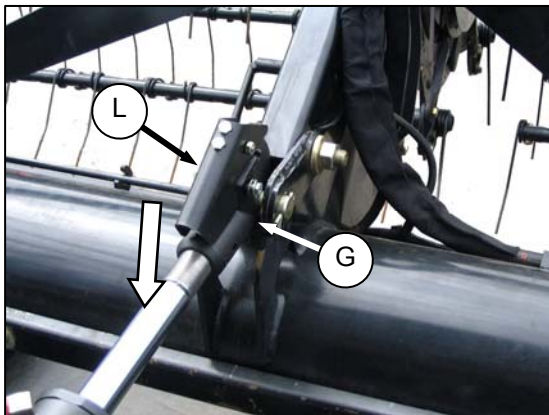

3. Push down on rod end of link cylinder until hook (G) engages pin on header, and is locked.

### IMPORTANT

Hook release (L) must be down to enable self-locking mechanism. If the release is open (up), manually push it down after hook engages header pin.

4. Check that center-link is locked onto header by pulling upward on rod end of cylinder.
5. Proceed to step g. in next column.

### MECHANICAL LINK



### WARNING

Stop windrower engine, and remove key before making adjustments to machine. A child or even a pet could engage the drive.

1. Stop engine, and remove key from ignition.

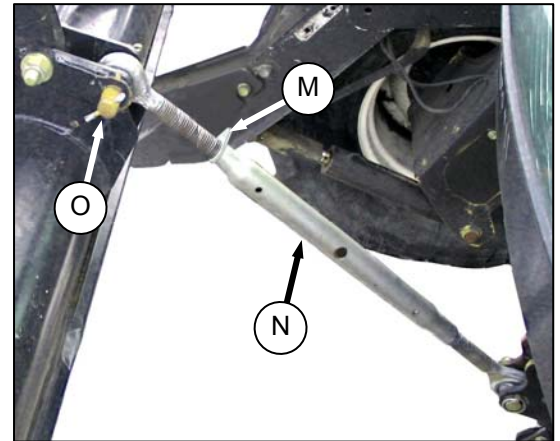

2. Loosen nut (M), and rotate barrel (N) to adjust length so that the link lines-up with header bracket.
3. Install pin (O), and secure with cotter pin.
4. Adjust link to required length for proper header angle by rotating barrel (N). Tighten nut (M) against barrel. A slight tap with a hammer is sufficient.



### CAUTION

Check to be sure all bystanders have cleared the area.

- g. Start engine, and press HEADER UP switch to raise header to maximum height.

*(continued next page)*

## HEADER OPERATION - D SERIES



### DANGER

To avoid bodily injury from fall of raised header, always engage header lift cylinder stops when working on or around raised header, and before going under header for any reason.

- h. Engage lift cylinder stops on both lift cylinders. Refer to Section 6.4.1 *Header Lift Cylinder Stops*.

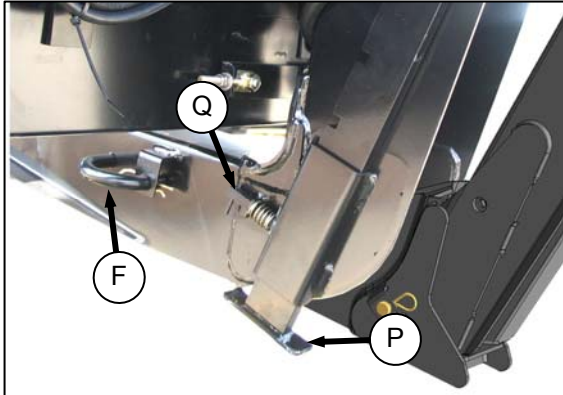

- i. Install pin (F) through header leg, (engaging U-bracket in lift linkage) on both sides, and secure with hairpin.
- j. Raise header stand (P) by pulling pin (Q), and lifting stand into uppermost position. Release pin (Q).

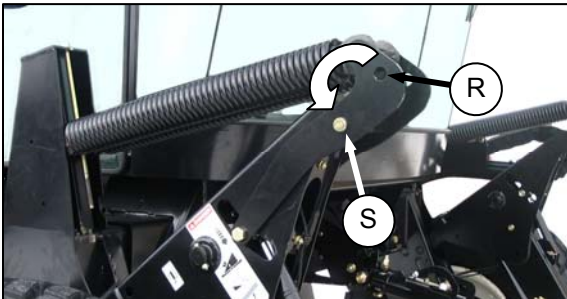

- k. Remove pin from storage location (R) in linkage, and insert in hole (S) to engage float springs. Secure with hairpin.

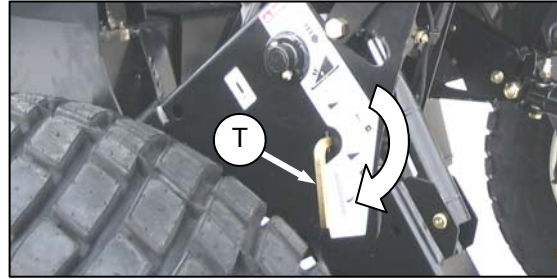

- l. Disengage lift cylinder stop by turning lever (T) downward to release and lower stop until lever locks into vertical position.
- m. Repeat for opposite lift cylinder stop.



### CAUTION

Check to be sure all bystanders have cleared the area.

- n. Start engine, and activate HEADER DOWN switch on GSL to lower header fully. Stop engine, and remove key.



### WARNING

Stop windrower engine, and remove key before making adjustments to machine. A child or even a pet could engage the drive.



- o. Connect header drive hoses (V) and electrical harness (W) to header. Refer to the Draper Header Operator's Manual.

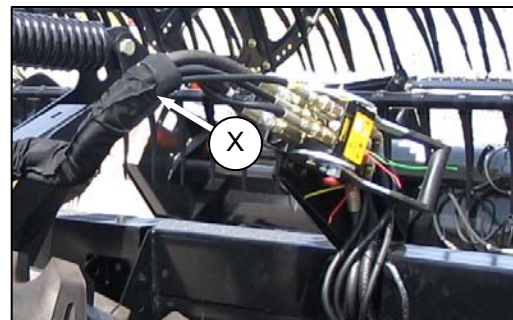

- p. Connect reel hydraulics (X) at RH side of windrower. Refer to the Draper Header Operator's Manual.

## HEADER OPERATION - D SERIES

### 6.5.4 Header Position

Refer to Section 6.4 HEADER OPERATION for procedures for controlling header height, header tilt, and float.

### 6.5.5 Reel Fore-Aft Position

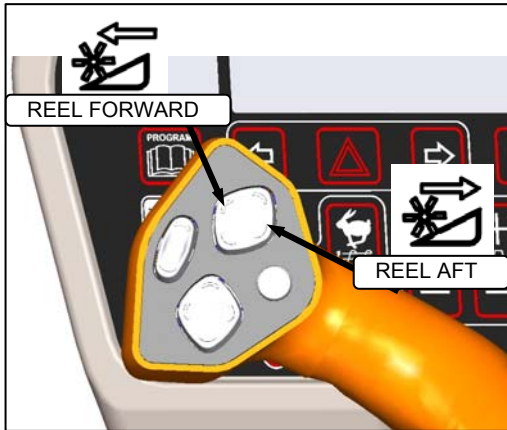

- Press and hold the switch for the desired fore or aft movement of the reel.

### 6.5.6 Reel Height

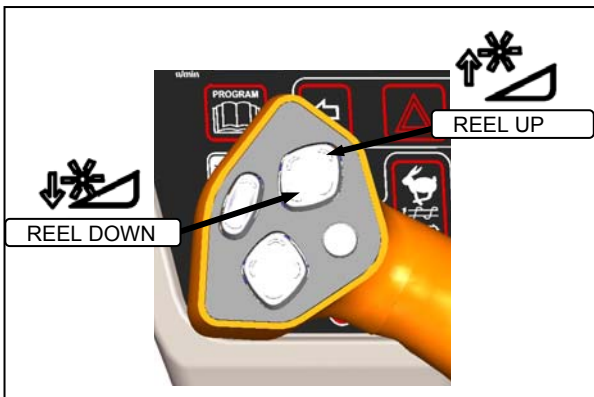

- Press and hold the switch for the desired up or down movement of the reel.

#### **IMPORTANT**

Under certain conditions, with reel raised to full height, the reel tines may contact the cab roof. Exercise care to avoid damage to the machine.

# HEADER OPERATION - D SERIES

## 6.5.7 Reel Speed

The speed of the reel is controlled with switches on the GSL in the cab. On D Series draper headers, it can be set relative to the ground speed of the windrower using the HEADER INDEX feature, or can run independently.

Refer to the Operator's Manual for your specific header for windrowing guidelines and recommended speeds.

### 6.5.7.1 Reel to Ground Speed

Setting the speed of the reel relative to ground speed using the HEADER INDEX function allows the Operator to maintain a preset reel to ground speed, while operating at varying ground speeds.

This feature requires that an optional module has been installed, either at the factory or at your MacDon Dealer.

To use this feature, set the Minimum Reel Speed, and set the Reel Index as follows:

#### a. Set Reel Minimum Speed

##### IMPORTANT

Windrower can be moving, but must be less than minimum reel speed.



##### CAUTION

Check to be sure all bystanders have cleared the area.

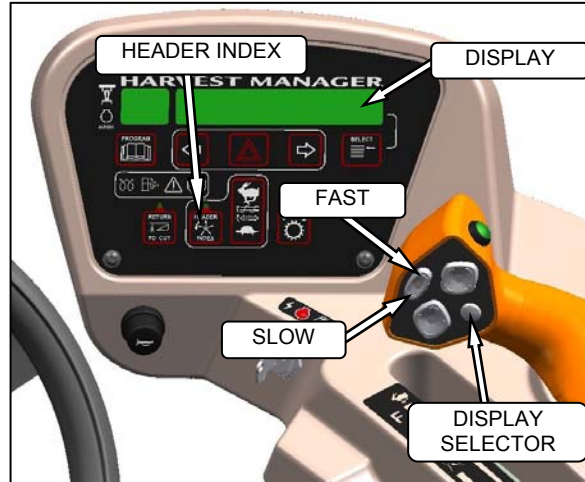
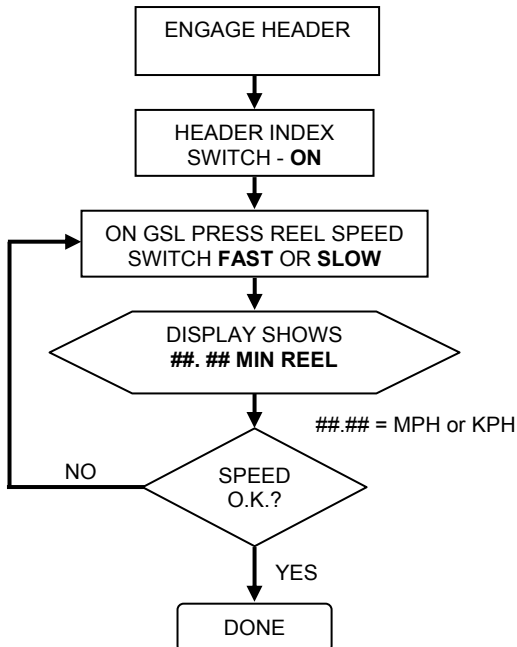

##### NOTE

DISPLAY will flash ###.## MIN REEL (MPH or KPH) to prompt the Operator to change the minimum set point or increase ground speed if Ground Speed Plus Index is less than the Minimum Reel Speed Set Point.

#### b. Set Reel Index while driving windrower at normal operating speed and greater than minimum reel speed.

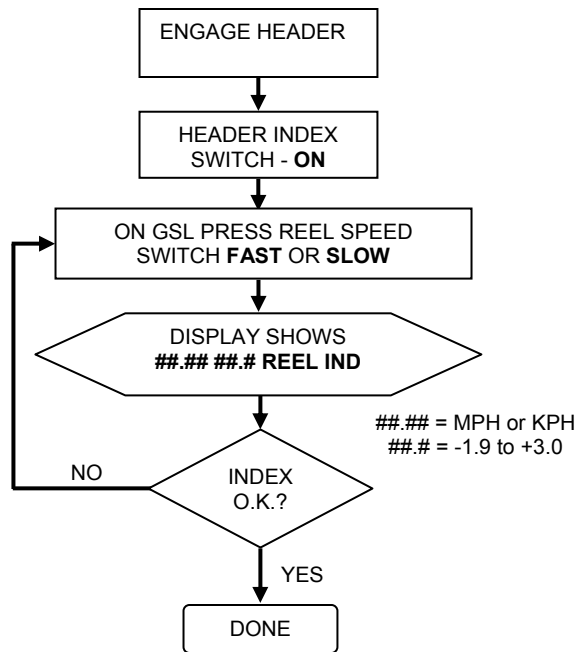

##### NOTE

See example on following page.

(continued next page)



## HEADER OPERATION - D SERIES

### **Example:**

- Windrower is operating at 8 mph with HEADER INDEX ON, and set at -1.0.

Display shows:

**7.0 -1.0 REEL IND**

where **7.0** (8.0 - 1.0) is the reel speed in mph, and **-1.0** is the HEADER INDEX setting.

- Windrower speed drops to 7.5 mph at same HEADER INDEX setting.

Display shows:

**6.5 -1.0 REEL IND**

where **6.5** (7.5 - 1.0) is the reel speed in mph, and **-1.0** is the HEADER INDEX setting.

- Windrower is operating at 8 mph with HEADER INDEX ON, and set at 2.0.

Display shows:

**10.0 2.0 REEL IND**

where **10.0** (8 + 2.0) is the reel speed in mph, and **2.0** is the HEADER INDEX setting.

# HEADER OPERATION - D SERIES

## 6.5.8 Draper Speed

Draper speed affects the orientation of stalks in the windrow. Faster draper speeds tend to form herringbone or dovetail configurations. Refer to your Header Operator's Manual for guidelines on what speed to use.

The draper speed can be set with switches on the CDM relative to the ground speed of the windrower with the HEADER INDEX function, or can run independently.



### CAUTION

Check to be sure all bystanders have cleared the area.

#### 6.5.8.1 Draper To Ground Speed - Index (Optional)

To use this feature, set the Draper Minimum Speed, and set the Draper Index.

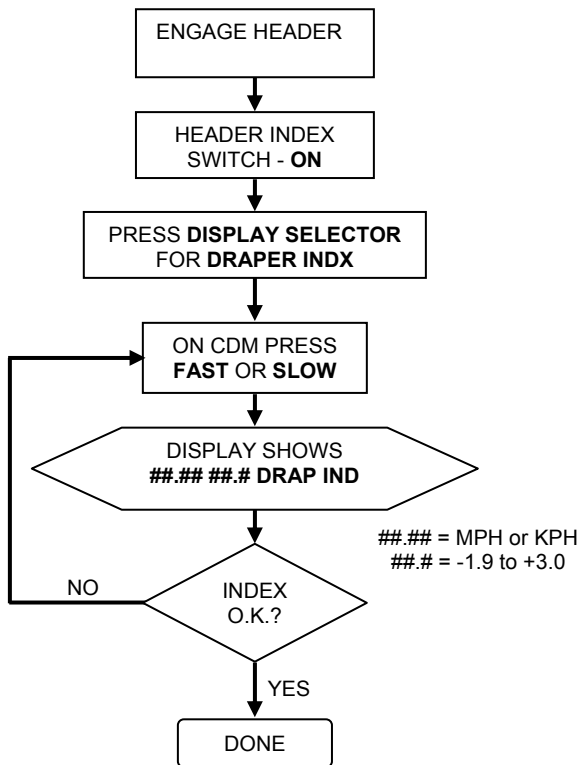

### NOTE

Reducing engine speed saves fuel and reduces noise in the cab. Ground/cutting speed can be maintained using this feature.

#### a. Set Draper Minimum Speed:

### IMPORTANT

Windrower can be moving but must be less than minimum reel speed.

### NOTE

DISPLAY will flash ###.## MIN CONV (MPH or KPH) to prompt the Operator to change the minimum set point or increase ground speed if Ground Speed Plus Index is less than the Minimum Draper Speed Set Point.

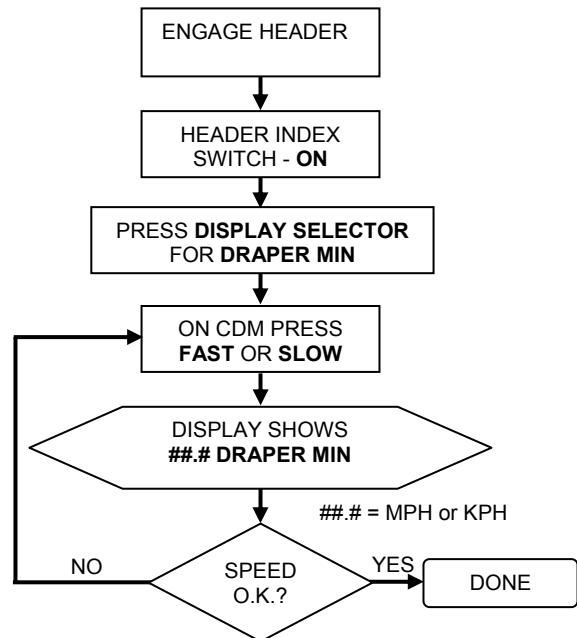
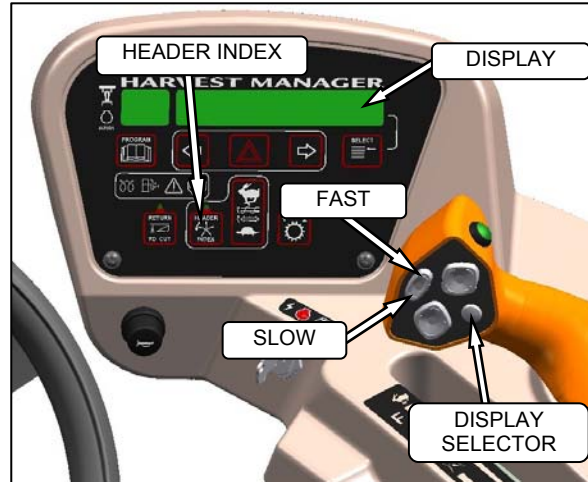

#### b. Set Draper Index while driving windrower at normal operating speed and greater than minimum draper speed.

### NOTE

See example on following page.

(continued next page)

## HEADER OPERATION - D SERIES

### Example:

- Windrower is operating at 8 mph with HEADER INDEX ON, and set at 1.5.

Display shows:

**9.5 1.5 DRAP INDX**

where **9.5** ( $8 + 1.5$ ) is the draper speed in mph, and **1.5** is the HEADER INDEX setting.

- Windrower speed drops to 7.5 mph at same HEADER INDEX setting.

Display shows:

**9.0 1.5 DRAP INDX**

where **9.0** ( $7.5 + 1.5$ ) is the draper speed in mph, and **1.5** is the HEADER INDEX setting.

- Windrower is operating at 8 mph with HEADER INDEX ON, and set at 0.9.

Display shows:

**8.9 0.9 DRAP INDX**

where **8.9** ( $8 + 0.9$ ) is the draper speed in mph, and **0.9** is the HEADER INDEX setting.

### 6.5.8.2 Draper Speed Independent of Ground Speed

Set the speed of the draper independently of ground speed as follows:

#### NOTE

*This procedure can also be used to change the draper speed on the go.*



#### CAUTION

Check to be sure all bystanders have cleared the area.

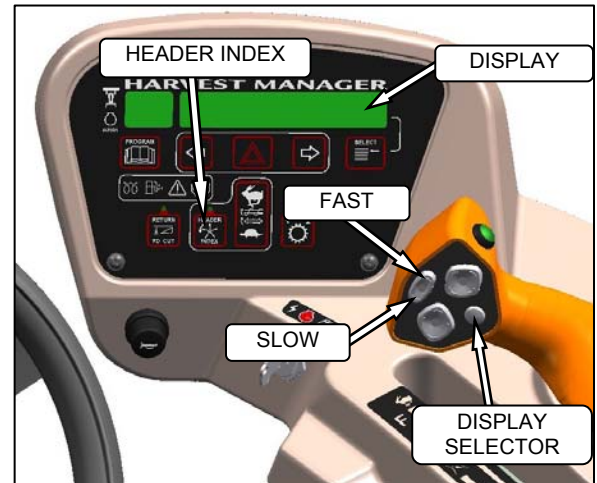

## HEADER OPERATION - D SERIES

### 6.5.9 Knife Speed

The ideal cutting speed of the knife should be such that a clean cut is achieved. Crop types and conditions usually influence the knife and forward speeds. Refer to the Header Operator's Manual for more information on knife speeds.

The knife speed is manually set by making adjustments to the knife drive pump, and has been pre-set at the factory. For optimum performance, adjust the knife speed according to the header being used. Refer to the following table.

If the machine is equipped with the appropriate sensor and optional module, the CDM will notify the Operator when the knife speed reaches an overload pre-set (usually 75% of knife speed).

The pre-set can be changed on the CDM. Refer to Section 5.18.5 *Cab Display Module (CDM) Programming*.

#### NOTE

*The knife speed should stay within the range specified for each header.*

HEADER DESCRIPTION		KNIFE SPEED			
TYPE	SIZE (FT)	MINIMUM		MAXIMUM	
		RPM	SPM	RPM	SPM
Draper DK	15	750	1500	950	1900
	20 and 25	700	1400	850	1700
	30	600	1200	800	1600
	35			700	1400
Draper SK	20 and 25	600	1200	750	1500
	30			700	1400
	35	550	1100		

RPM = speed of wobble box pulley.

SPM = strokes per minute of knife (RPM x 2).

- Start engine. See 6.3.4.1 *Starting*.
- Move throttle to adjust engine speed to idle.
- Set the Intermediate Speed Control (ISC) to OFF. See 5.18.5. *CDM Programming*.
- Engage header.

- Run engine at maximum rpm.

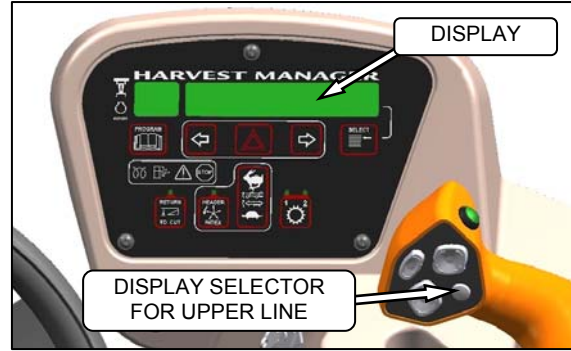

- Press SELECTOR button on the GSL until the CDM displays the knife speed in SPM (strokes per minute). This indicates that Optional Sensors Expansion Module B4666 is installed.

If knife speed is not displayed, the Module is not installed, proceed to step i:

- Compare reading to the table opposite.
- If required, adjust knife speed as follows:



### DANGER

**Stop engine, and remove key from ignition before leaving Operator's seat for any reason. A child or even a pet could engage an idling machine.**

- Shut down engine, and open engine hood.

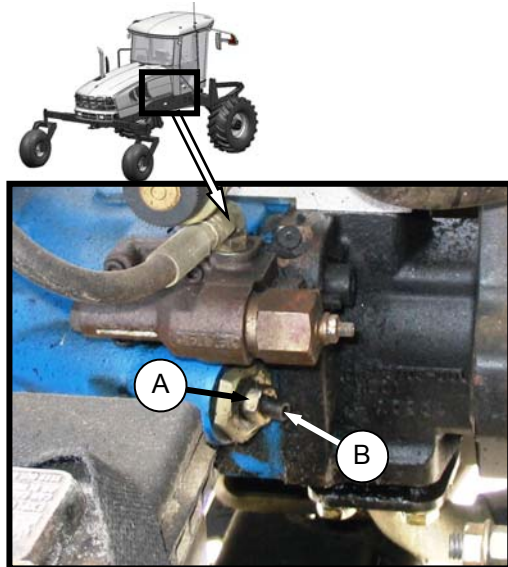

- Loosen jam-nut (A).
- Turn adjuster screw (B) clockwise (screw in) to decrease knife speed, and counter clockwise (screw out) to increase the knife speed.

*(continued next page)*

## HEADER OPERATION - D SERIES

### NOTE

One turn of the adjuster screw (B) will change the knife speed by approximately 116 strokes per minute, or the wobble box pulley speed by 58 revolutions per minute.

4. Once adjustment has been made, re-torque jam nut (A) as shown on previous page.
5. Close hood, start engine, and re-check knife speed.
- i. For windrowers not equipped with the Optional Sensors Expansion Module B4666:



1. Check wobble box pulley speed with a hand-held tachometer.
2. Multiply the rpm reading by two for the knife speed in strokes per minute.
3. Compare reading to the table on the previous page.
4. If required, adjust knife speed. See step i. on previous page.

### 6.5.10 Deck Shift (Optional)

The hydraulic deck shift option allows the Operator to control deck position and draper rotation from the Operator's station.

It enables crop delivery from left side, center, or right side of the header.

Shift decks as follows:



### CAUTION

Check to be sure all bystanders have cleared the area.

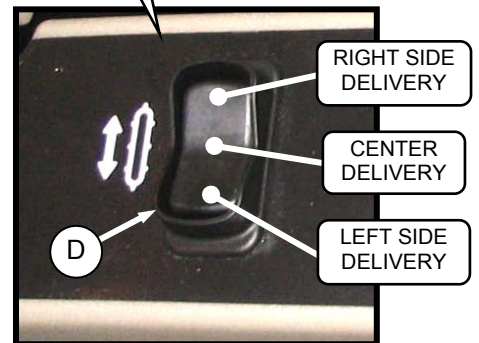
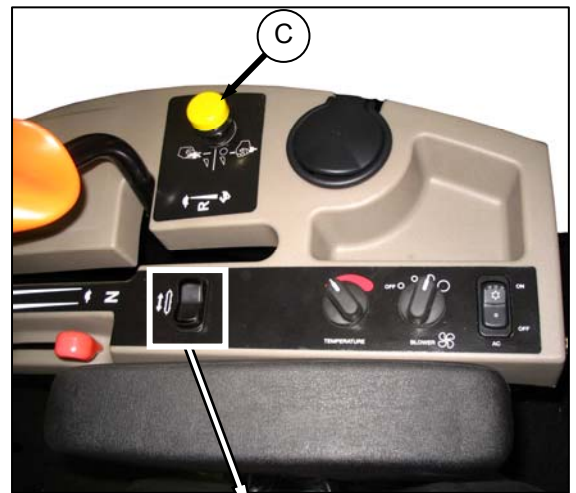

- a. Engage header by pushing down on the yellow knob, and pulling up on the black ring at the base of the switch (C).
- b. Push rocker switch (D) to desired delivery position. Deck(s) will move, and direction of drapers will change accordingly.
- c. Operate windrower.

## HEADER OPERATION - D SERIES

### 6.5.11 Header Detachment

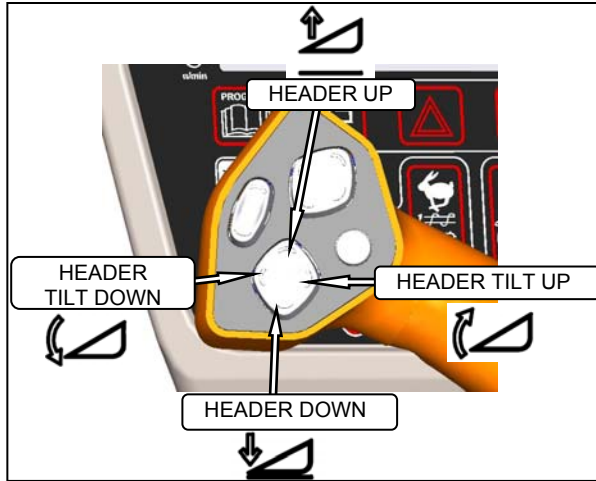

- a. Raise header fully with the HEADER UP switch on the GSL. Stop engine, and remove key.



### DANGER

To avoid bodily injury from fall of raised header, always engage header lift cylinder stops when working on or around raised header.

- b. Engage lift cylinder stops on both lift cylinders. Refer to Section 6.4.1 Header Lift Cylinder Stops.

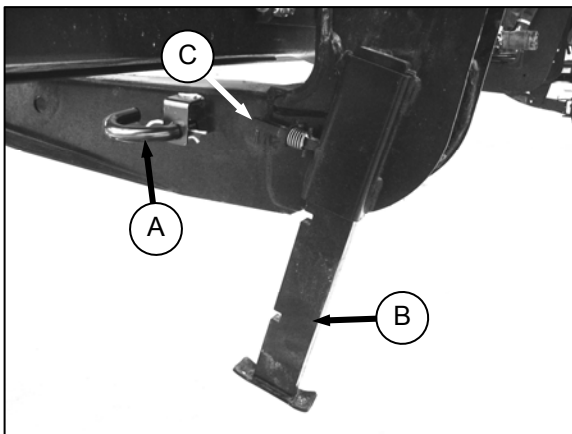

- c. Remove pin (A) from header leg on both sides.
- d. Lower header stand (B) by pulling spring loaded pin (C). Release pin to lock stand.

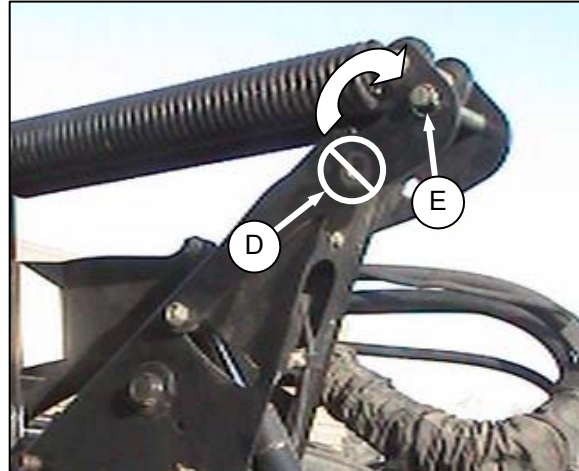

- e. Remove pin from location (D) to disengage float springs, and insert in storage hole (E). Secure with lynch pin.

### IMPORTANT

To prevent damage to the lift system when lowering header lift linkages without a header or weight box attached to windrower, ensure that float engagement pin is installed in storage location (E), and not installed at hole location (D).

- f. Disengage lift cylinder stops.



### CAUTION

Check to be sure all bystanders have cleared the area.

- g. Start engine, choose a level area, and lower header to the ground.
- h. If applicable, activate HEADER TILT switches on GSL to release load on center-link cylinder.
- i. Stop engine, and remove key.

*(continued next page)*

## HEADER OPERATION - D SERIES



- j. Disconnect header drive hydraulics (F) and electrical harness (G) from header. Refer to the Draper Header Operator's Manual.

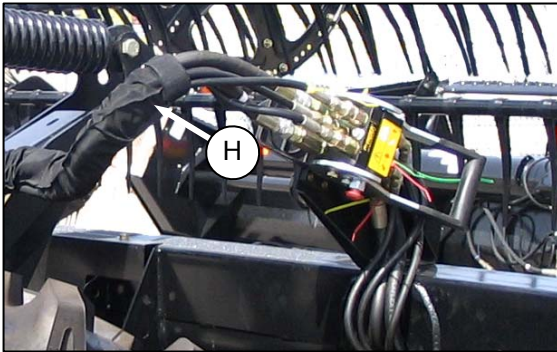

- k. Disconnect reel hydraulics (H), and store on bracket at windrower LH side.  
l. Disconnect center-link as follows:

### HYDRAULIC LINK

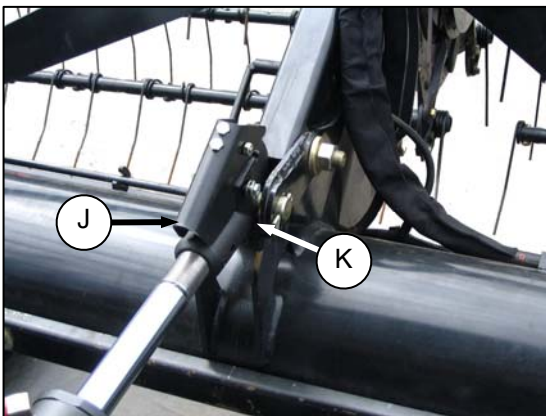

1. Disconnect center-link by lifting release (J), and lifting hook (K) off header.

### MECHANICAL LINK

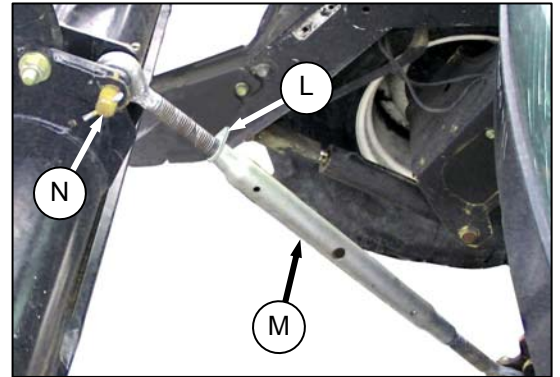

1. Loosen nut (L), and rotate barrel (M), to relieve load on link.
2. Remove cotter pin on pin (N), and remove pin to disconnect from windrower. Re-install pin in header.
3. Tighten nut (L) against barrel. A slight tap with a hammer is sufficient.



### CAUTION

**Check to be sure all bystanders have cleared the area.**

- m. Start engine, and slowly back windrower away from header.

### NOTE

*If hay conditioner is installed, watch clearances on both sides.*

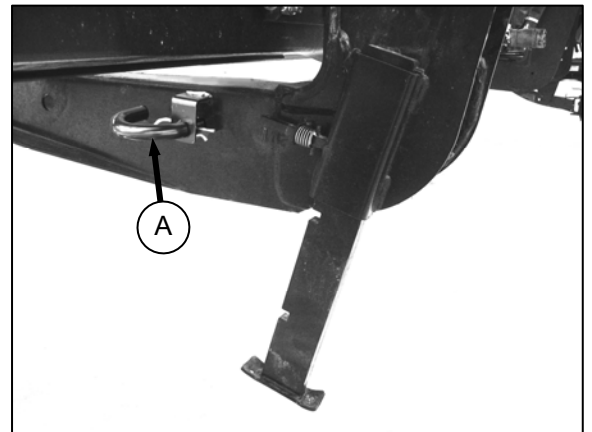

- n. Re-install pin (A) into header leg, and secure with hairpin.

## HEADER OPERATION - A SERIES

### 6.6 A SERIES HEADER OPERATION



#### 6.6.1 Header Attachment

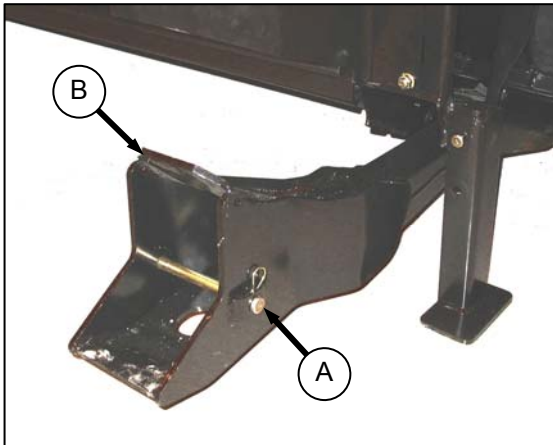

- a. Remove hairpin from pin (A), and remove pin from left and right header boots (B) on header.

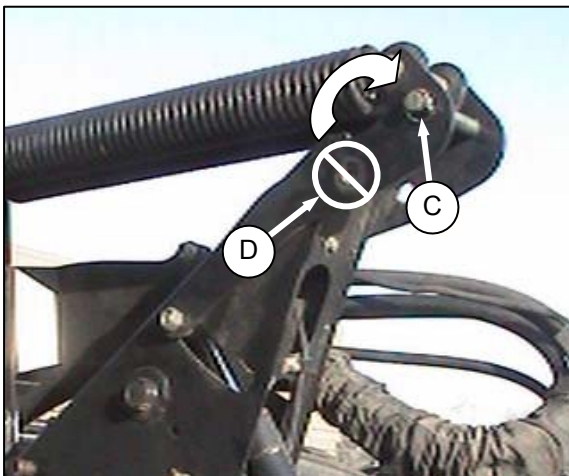

#### IMPORTANT

To prevent damage to the lift system when lowering header lift linkages without a header or weight box attached to windrower, ensure that float engagement pin is installed in storage location (C), and not installed at hole location (D).

#### IMPORTANT

For machines equipped with the hydraulic center-link, it may contact the header as the windrower approaches the header for hook-up.

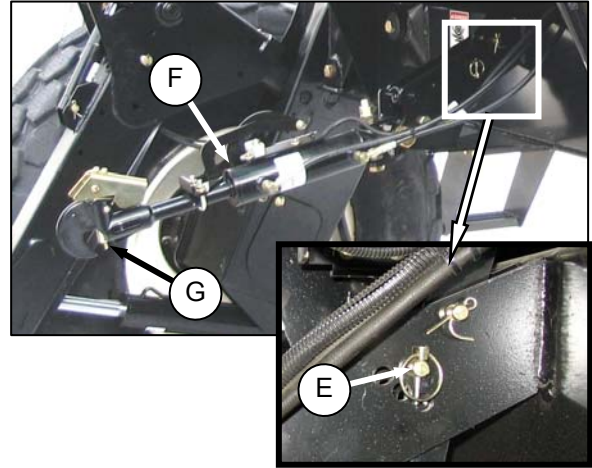

- b. If necessary, re-locate the pin (E) at the frame linkage as required to raise the center-link (F) so that the hook (G) is above the attachment pin on the header.



#### CAUTION

Check to be sure all bystanders have cleared the area.

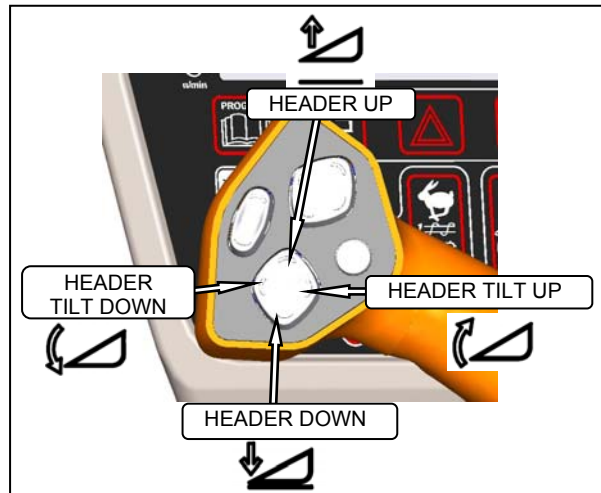

- c. Start the engine, and activate HEADER DOWN button on the GSL to fully retract header lift cylinders.

*(continued next page)*



## HEADER OPERATION - A SERIES

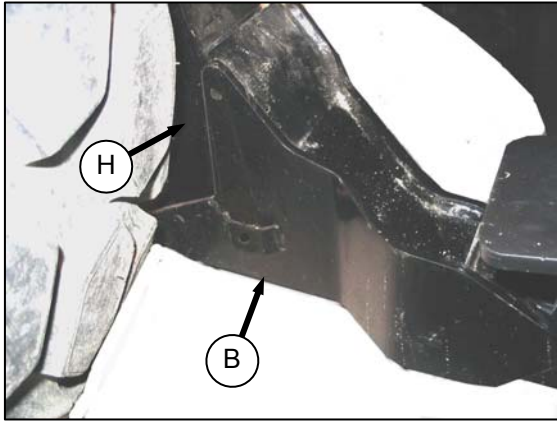

- d. Slowly drive windrower forward so that feet (H) on windrower enter boots (B) on the header. Continue to drive slowly forward until feet engage the boots, and header nudges forward.
- e. Connect center-link as follows:

### HYDRAULIC LINK

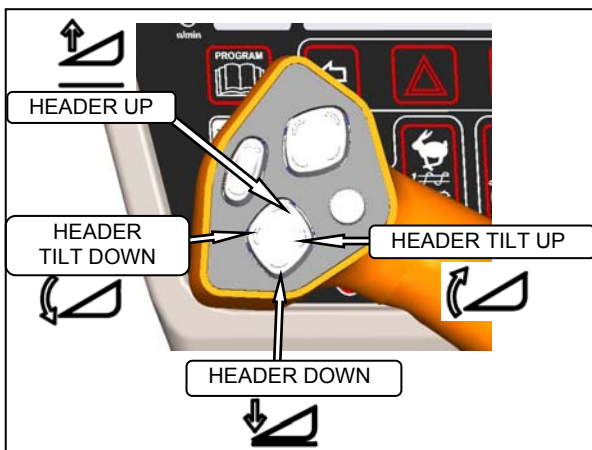

1. Activate HEADER TILT cylinder switches on GSL to extend or retract center-link cylinder so that the hook lines-up with the header attachment pin.
2. Stop engine and remove key from ignition.

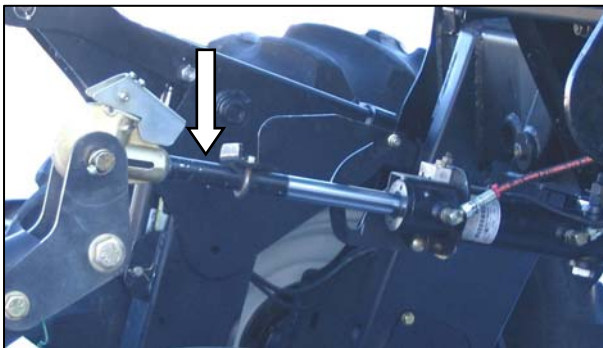

3. Push down on rod end of link cylinder until hook engages pin on header, and is locked.

### IMPORTANT

Hook release must be down to enable self-locking mechanism. If the release is up, manually push it down after hook engages header pin.

4. Check that center-link is locked onto header by pulling upward on rod end of cylinder.
5. Proceed to step f. below.

### MECHANICAL LINK



### WARNING

**Stop windrower engine, and remove key before making adjustments to machine. A child or even a pet could engage the drive.**

1. Stop engine and remove key from ignition.

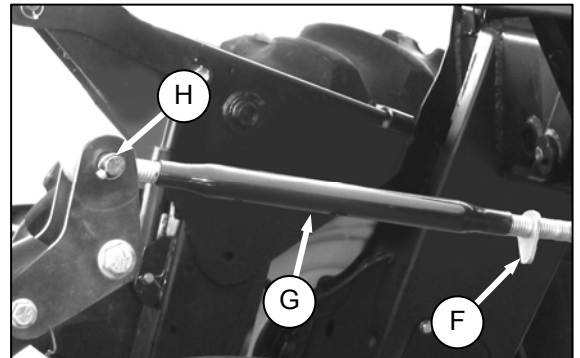

2. Loosen nut (F), and rotate barrel (G), to adjust length so that other end lines-up with header bracket.
3. Install pin (H), and secure with cotter pins.
4. Adjust link to required length for proper header angle by rotating barrel (G). Tighten nut (F) against barrel. A slight tap with a hammer is sufficient.



### CAUTION

**Check to be sure all bystanders have cleared the area.**

- f. Start engine, and raise the header fully with the HEADER UP switch on the GSL.
- g. Stop engine, and remove key.

*(continued next page)*

## HEADER OPERATION - A SERIES



### DANGER

To avoid bodily injury from fall of raised header, always engage header lift cylinder stops when working on or around raised header, and before going under the header for any reason.

- h. Engage lift cylinder stops on both lift cylinders. Refer to Section 6.4.1 *Header Lift Cylinder Stops*.

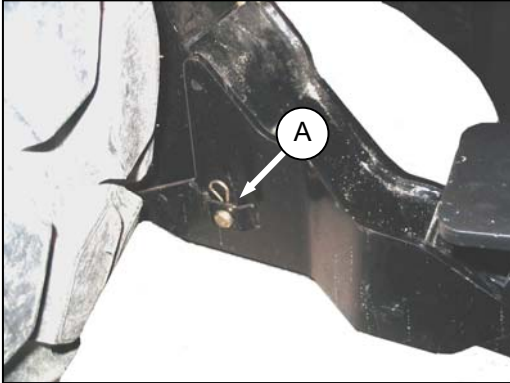

- i. Install pin (A) through each boot and foot, and secure with hairpin.

#### IMPORTANT

Ensure pin (A) is fully inserted, and hairpin is installed behind bracket.

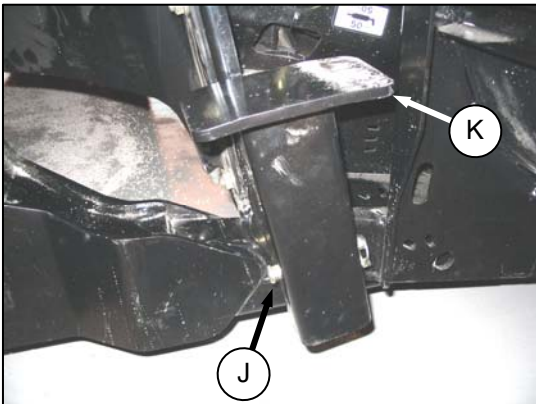

- j. Remove lynch pin from pin (J) in stand (K).
- k. Hold stand, and remove pin (J).
- l. Move stand to storage position by inverting stand, and re-locating on bracket as shown. Re-insert pin (J), and secure with lynch pin.

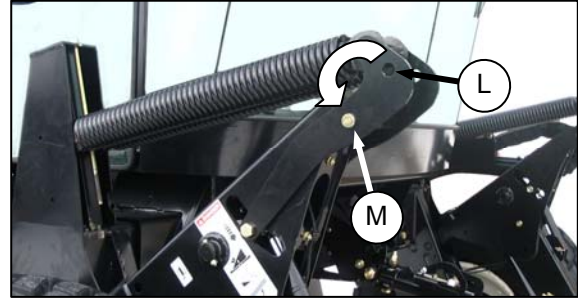

- m. Remove pin (L) from storage location in linkage, and insert in hole (M) to engage float springs. Secure with lynch pin.
- n. Disengage lift cylinder stops. Refer to Section 6.4.1 *Header Lift Cylinder Stops*.
- o. Start engine, and activate HEADER LIFT cylinder switch on GSL to lower header fully. Stop engine, and remove key.

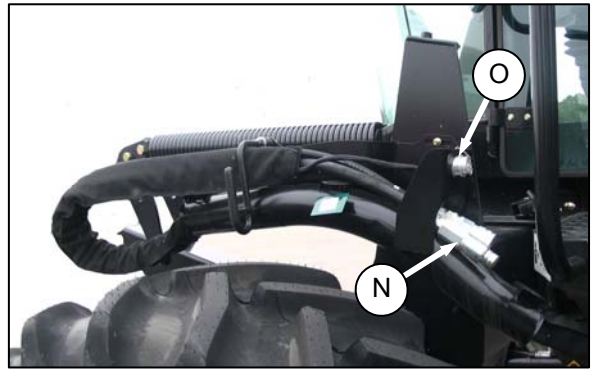

- p. Connect header drive hydraulics (N) and electrical harness (O) to header. Refer to Auger Header Operator's Manual.

# HEADER OPERATION - A SERIES

## 6.6.2 Auger Speed



### CAUTION

Check to be sure all bystanders have cleared the area.

### 6.6.2.1 A40-D Headers

On A40-D double knife headers, the auger speed is interdependent on reel speed, and is controlled by a switch on the GSL.

Change auger speed as follows:

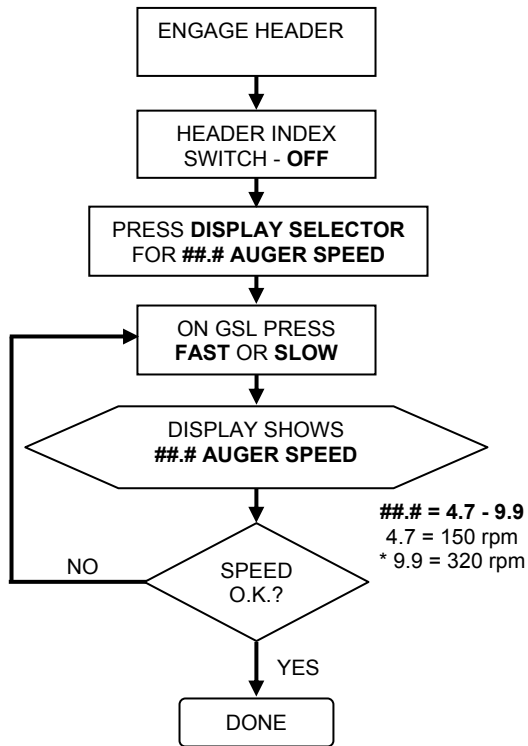

\* Auger Speed Not To Exceed 320 rpm.

### 6.6.2.2 A30-S and A30-D Headers

On A30 Series auger headers, the auger speed is fixed to the knife speed.

#### NOTE

The auger speed can be independently changed from the knife speed by changing the drive sprocket. Refer to A30-S, A30-D and A40-D Self Propelled Windrower Headers Operator's Manual.

Display the auger speed as follows:

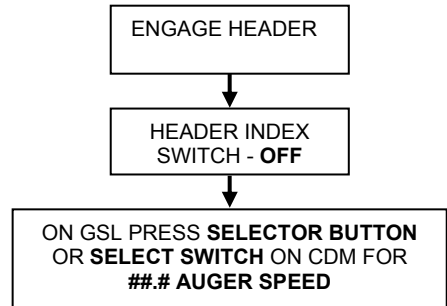
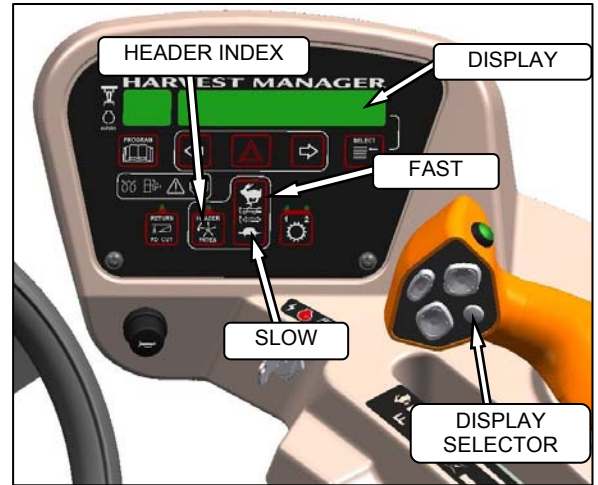

### = 00.0 - 99.0

00.0 = 150 rpm

\* 99.0 = 320 rpm

\* Auger Speed Not To Exceed 320 rpm.

# HEADER OPERATION - A SERIES

## 6.6.3 Reel Speed

### 6.6.3.1 A30-S and A30-D Headers

The reel speed is fixed to the auger speed and to the knife speed. Both can be changed by installing alternate drive sprockets. Refer to your Auger Header Operator's Manual.

### 6.6.3.2 A40-D Header

The A40-D auger header features a hydraulic direct drive reel with operating speed range of 15 - 50 rpm that is controlled with switches on the CDM, and on the GSL at the Operator's station.

The hydraulic flows for the reel and auger are interconnected so that the auger and reel speeds are controlled using the GSL switches.

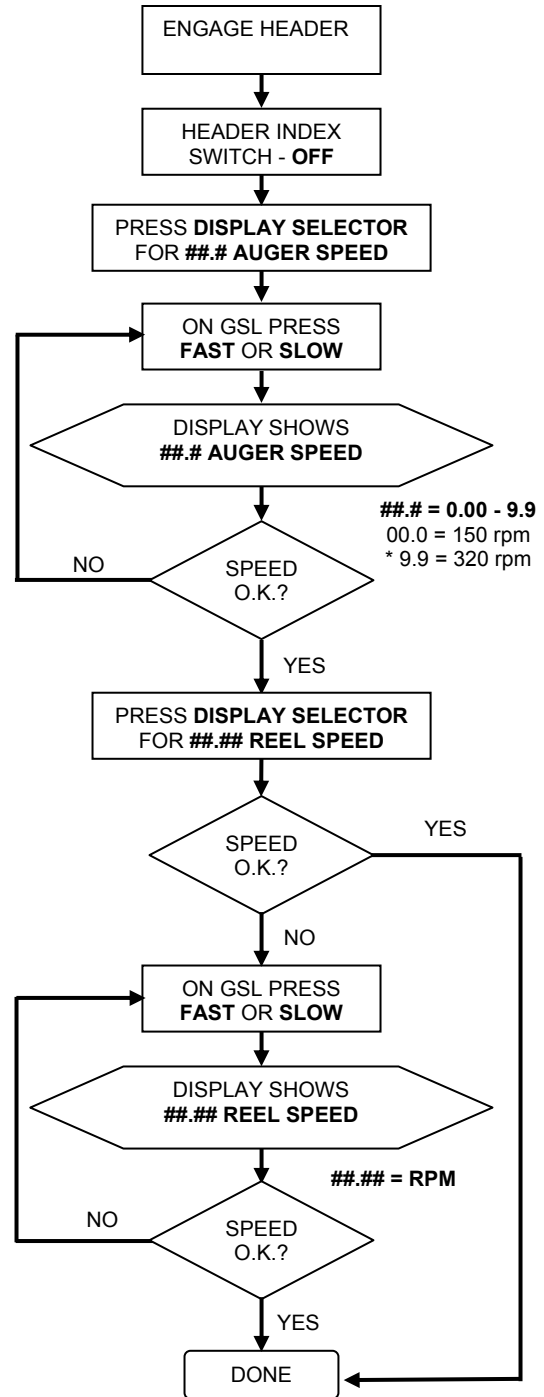
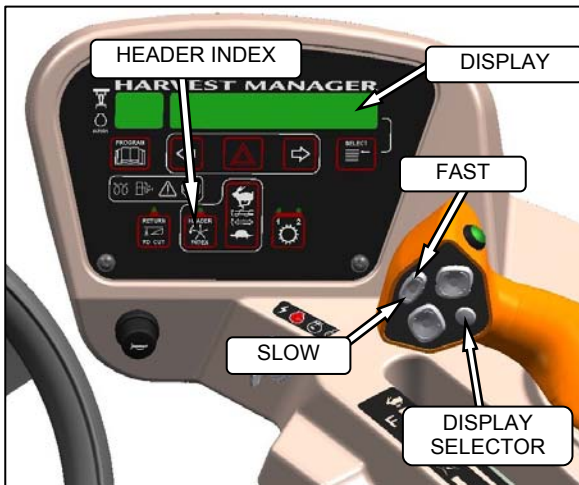

\* Auger Speed Not To Exceed 320 rpm.

## HEADER OPERATION - A SERIES

### 6.6.4 Knife Speed

The ideal cutting speed of the knife should be such that a clean cut is achieved. Crop types and conditions usually influence the knife and forward speeds.

The knife speed is manually set by making adjustments to the knife drive pump, and has been pre-set at the factory.

For optimum performance, adjust the knife speed according to the header being used. See the following table.

If the machine is equipped with the appropriate sensor and optional module, the CDM will notify the Operator when the knife speed reaches an overload pre-set (usually 75% of knife speed).

The pre-set can be changed on the CDM. Refer to Section 5.18.5 *Cab Display Module (CDM) Programming*

#### NOTE

*The knife speed should stay within the range specified for each header.*

HEADER DESCRIPTION		KNIFE SPEED			
TYPE	SIZE	MINIMUM		MAXIMUM	
		RPM	SPM	RPM	SPM
Auger A40-D	All	700	1400	975	1950
Auger A30-D		775	1550	925	1850
Auger A30-S		625	1250	775	1550

RPM = speed of wobble box pulley.  
SPM = strokes per minute of knife (RPM x 2).

- Start engine. See 6.3.4.1 *Starting*.
- Move throttle to adjust engine speed to idle.
- Set the Intermediate Speed Control (ISC) to OFF. See 5.18.5. *CDM Programming*.
- Engage header.

- Run engine at maximum rpm.

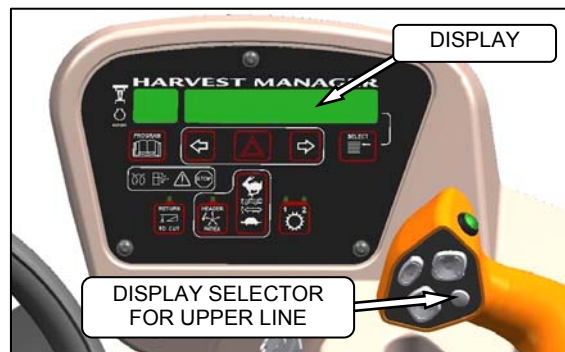

- Press SELECTOR button on the GSL until the CDM displays the knife speed in SPM (strokes per minute). This indicates that Optional Sensors Expansion Module B4666 is installed.

If knife speed is not displayed, the Module is not installed, proceed to step j:

- Compare reading to the table opposite.
- If required, adjust knife speed as follows:



### DANGER

**Stop engine, and remove key from ignition before leaving Operator's seat for any reason. A child or even a pet could engage an idling machine.**

- Shut down engine, and open engine hood.

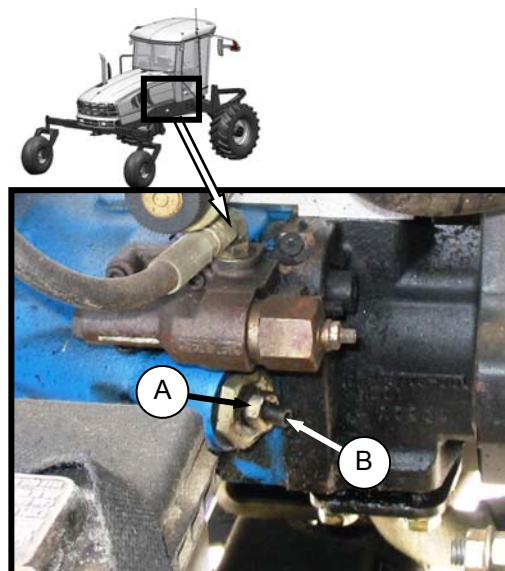

- Loosen jam-nut (A).
- Turn adjuster screw (B) clockwise (screw in) to decrease knife speed, and counter clockwise (screw out) to increase the knife speed.

*(continued next page)*

## HEADER OPERATION - A SERIES

### NOTE

*One turn of the adjuster screw (B) will change the knife speed by approximately 116 strokes per minute, or the wobble box pulley speed by 58 revolutions per minute.*

4. Once adjustment has been made, re-torque jam nut (A) as shown on previous page.
  5. Close hood, start engine, and re-check knife speed.
- i. For windrowers not equipped with the Optional Sensors Expansion Module B4666:



1. Check wobble box pulley speed with a hand-held tachometer.
2. Multiply the rpm reading by two for the knife speed in strokes per minute.
3. Compare reading to the table on the previous page.
4. If required, adjust knife speed. See step i. on previous page.

## HEADER OPERATION - A SERIES

### 6.6.5 Header Detachment

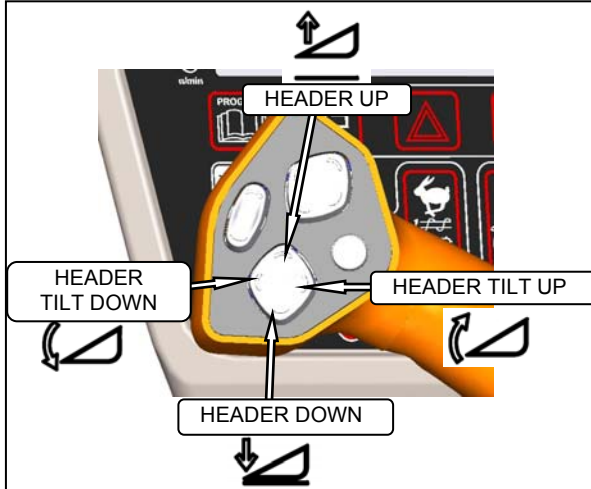

- a. Raise the header fully with the HEADER UP switch on the GSL. Stop engine, and remove key.



### DANGER

To avoid bodily injury from fall of raised header, always engage header lift cylinder stops when working on or around raised header, and before going under header for any reason.

- b. Engage lift cylinder stops on both lift cylinders. Refer to Section 6.4.1 *Header Lift Cylinder Stops*.

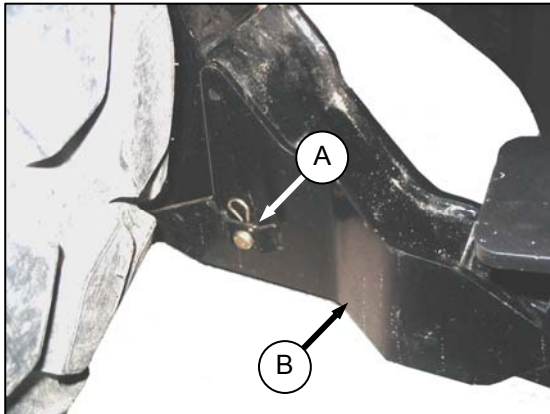

- c. Remove hairpin from pin (A), and remove pin from left and right header boots (B) on header.

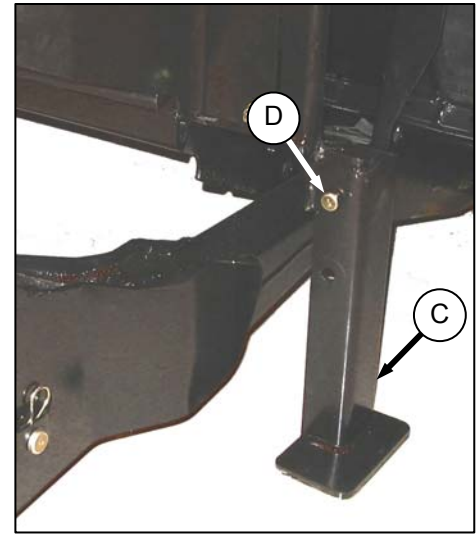

- d. Lower stand (C) by pulling pin (D), inverting stand, and re-locating on bracket. Re-insert pin (D), and secure with hairpin.

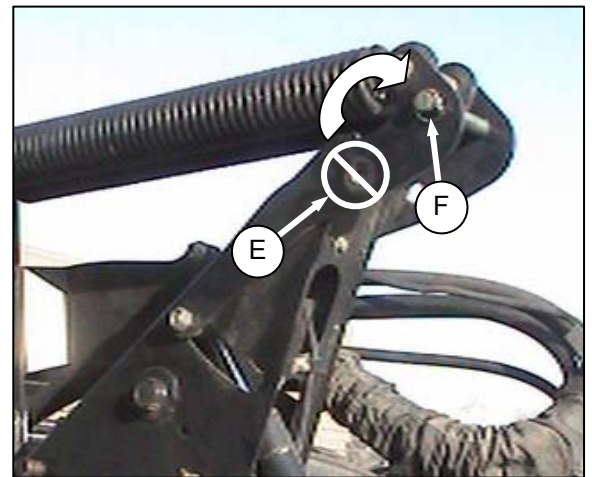

- e. Remove pin from linkage (E) to disengage float springs, and insert in storage hole (F). Secure with lynch pin. Repeat for opposite linkage.

### IMPORTANT

To prevent damage to the lift system when lowering header lift linkages without a header or weight box attached to windrower, ensure that float engagement pin is installed in storage location (F), and not installed at hole location (E).

- f. Disengage lift cylinder stops. Refer to Section 6.4.1 *Header Lift Cylinder Stops*.
- g. Start engine, choose a level area, and lower header to the ground.

(continued next page)

## HEADER OPERATION - A SERIES

h. Disconnect center-link:

### HYDRAULIC LINK (OPTIONAL)

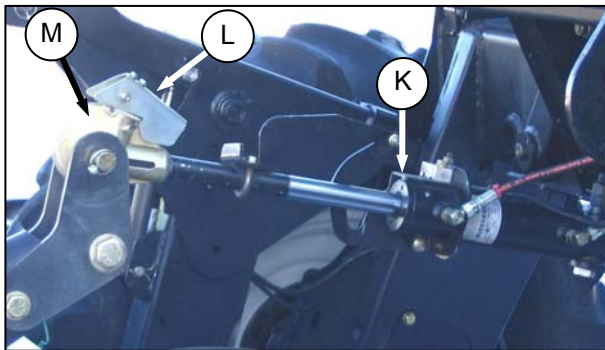
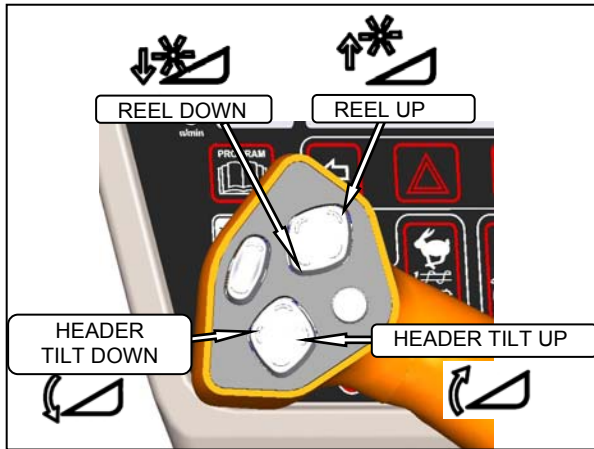

1. Activate HEADER TILT cylinder switches on GSL to release load on center-link cylinder (K).



### WARNING

Stop windrower engine, and remove key before making adjustments to machine. A child or even a pet could engage the drive.

2. Stop engine, and remove key from ignition.
3. Lift hook release (L), and lift hook (M) off header pin.
4. Proceed to step i. in next column.

### MECHANICAL LINK

1. Stop engine and remove key from ignition.

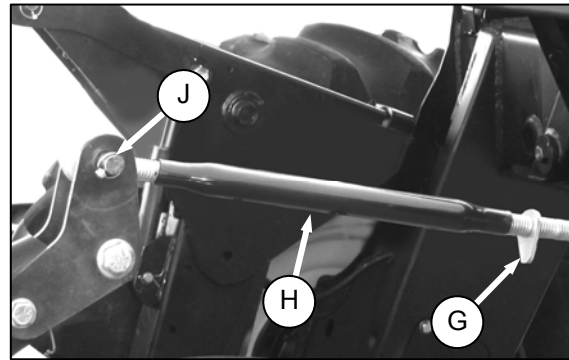

2. Loosen nut (G), and rotate barrel (H) to relieve load on link.
3. Remove cotter pin on pin (J), and remove pin to disconnect from header. Re-install pin in header.

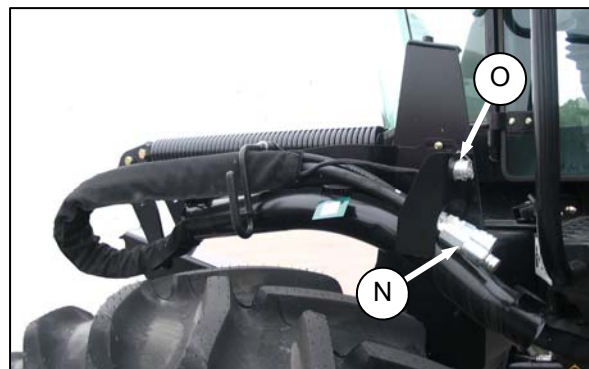

- i. Disconnect header drive hydraulics (N) and electrical harness (O). Refer to the Auger Header Operator's Manual.
- j. Slowly back windrower away from header.

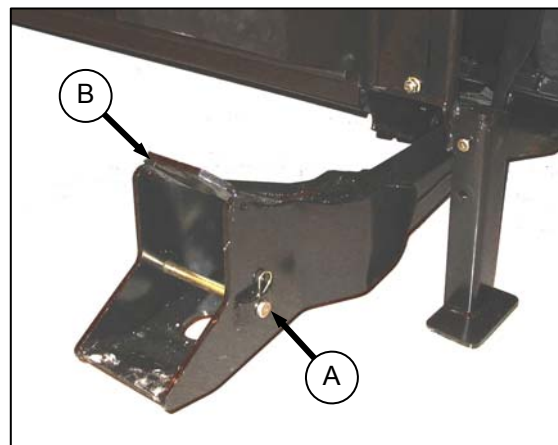

- k. Re-install pins (A) in header boots (B).



## MAINTENANCE AND SERVICING

### 7 MAINTENANCE AND SERVICING

The following instructions are provided to assist the Operator in the use of the M105 Windrower. Detailed maintenance, service, and parts information are contained in the Service Instruction Manual and Parts Catalog that are available from your MacDon Dealer.

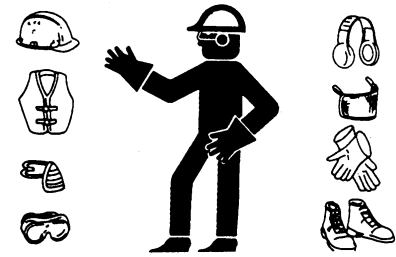

- Wear protective shoes with slip-resistant soles, a hard hat, protective glasses or goggles and heavy gloves.

#### 7.1 PREPARATION FOR SERVICING



#### WARNING

To avoid personal injury, before servicing adapter/header or opening drive covers:

- Fully lower the header. If necessary to service in the raised position, always engage lift cylinder stops.
- Disengage drives.
- Stop engine, and remove key.
- Wait for all moving parts to stop.



- If more than one person is servicing the machine at the same time, be aware that rotating a driveline or other mechanically driven component by hand (for example, accessing a lube fitting) will cause drive components in other areas (belts, pulleys, and sickle) to move. Stay clear of driven components at all times.

##### 7.1.1 Welding Precautions

#### IMPORTANT

High currents and voltage spikes associated with welding can cause damage to electronic components. Before welding on any part of the windrower or an attached header, disconnect all electronic module harness connections as well as the battery cables.

These electronic modules include:

- Engine Control Module (ECM).
- Windrower Control Module (WCM).
- Cab Display Module (CDM).



- Be prepared if an accident should occur. Know where the first aid kit and fire extinguishers are located, and how to use them.

#### 7.2 RECOMMENDED SAFETY PROCEDURES

- Wear close-fitting clothing and cover long hair. Never wear dangling items such as scarves or bracelets.
- Use adequate light for the job at hand.
- Replace all shields removed or opened for service.
- Park on a level surface when possible. Block wheels securely.



- Keep the service area clean and dry. Wet or oily floors are slippery. Wet spots can be dangerous when working with electrical equipment. Be sure all electrical outlets and tools are properly grounded.
- Use only service and repair parts made or approved by the equipment manufacturer. Substituted parts may not meet strength, design or safety requirements.
- Keep the machine clean. Never use gasoline, naphtha or any volatile material for cleaning purposes. These materials may be toxic and/or flammable.



# MAINTENANCE AND SERVICING

## 7.3 MAINTENANCE SPECIFICATIONS

### 7.3.1 Recommended Torques

The tables shown below give correct torque values for various bolts and capscrews.

- Tighten all bolts to the torques specified in chart (unless otherwise noted throughout this manual).
- Check tightness of bolts periodically, using bolt torque chart as a guide.
- Replace hardware with the same strength bolt.
- Torque figures are valid for non-greased or non-oiled threads and heads unless otherwise specified. Do not grease or oil bolts or capscrews (unless specified in this manual).
- When using locking elements, increase torque values by 5%.

#### 7.3.1.1 SAE Bolts

BOLT DIA. "A"	NC BOLT TORQUE*			
	SAE-5		SAE-8	
	lbf-ft	N·m	lbf-ft	N·m
1/4	9	12	11	15
5/16	18	24	25	34
3/8	32	43	41	56
7/16	50	68	70	95
1/2	75	102	105	142
9/16	110	149	149	202
5/8	150	203	200	271
3/4	265	359	365	495
7/8	420	569	600	813
1	640	867	890	1205

\* Torque categories for bolts and capscrews are identified by their head markings.

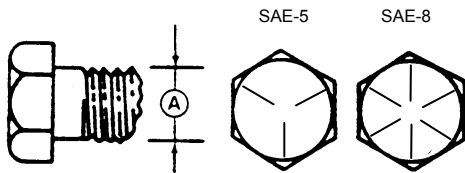

#### 7.3.1.2 Metric Bolts

BOLT DIA. "A"	STD COARSE BOLT TORQUE*			
	8.8		10.9	
	lbf-ft	N·m	lbf-ft	N·m
M3	0.4	0.5	1.3	1.8
M4	2.2	3	3.3	4.5
M5	4	6	7	9
M6	7	10	11	15
M8	18	25	26	35
M10	37	50	52	70
M12	66	90	92	125
M14	103	140	148	200
M16	166	225	229	310
M20	321	435	450	610
M24	553	750	774	1050
M30	1103	1495	1550	2100
M36	1917	2600	2710	3675

\* Torque categories for bolts and capscrews are identified by their head markings.

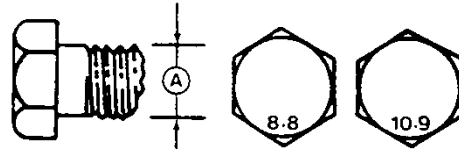

## MAINTENANCE AND SERVICING

### 7.3.1.3 Flare Type Hydraulic Fittings

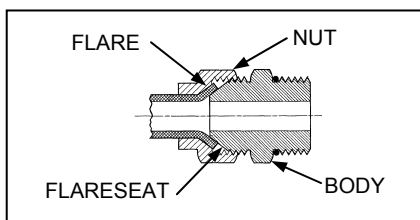

- Check flare and flare seat for defects that might cause leakage.
- Align tube with fitting before tightening.
- Lubricate connection, and hand-tighten swivel nut until snug.
- To prevent twisting the tube(s), use two wrenches. Place one wrench on the connector body, and with the second, tighten the swivel nut to the torque shown.

SAE NO.	TUBE SIZE O.D. (in.)	THD SIZE (in.)	NUT SIZE ACROSS FLATS (in.)	TORQUE VALUE*		RECOMMENDED TURNS TO TIGHTEN (AFTER FINGER TIGHTENING)	
				ft-lbf	N·m	Flats	Turns
3	3/16	3/8	7/16	6	8	1	1/6
4	1/4	7/16	9/16	9	12	1	1/6
5	5/16	1/2	5/8	12	16	1	1/6
6	3/8	9/16	11/16	18	24	1	1/6
8	1/2	3/4	7/8	34	46	1	1/6
10	5/8	7/8	1	46	62	1	1/6
12	3/4	1-1/16	1-1/4	75	102	3/4	1/8
14	7/8	1-3/8	1-3/8	90	122	3/4	1/8
16	1	1-5/16	1-1/2	105	142	3/4	1/8

\* Torque values shown are based on lubricated connections as in re-assembly.

### 7.3.1.4 O-Ring Boss (ORB) Hydraulic Fittings

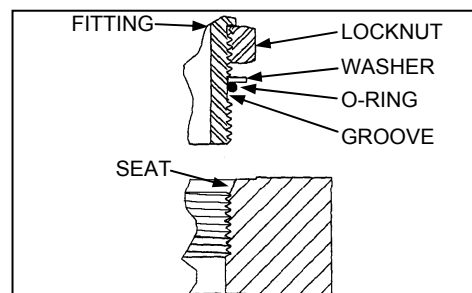

- Inspect O-ring and seat for dirt or obvious defects.

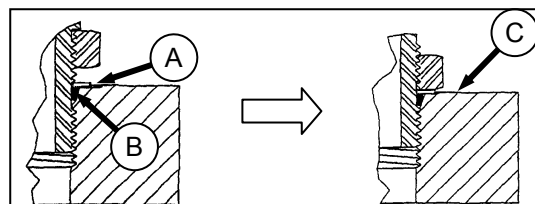

- On angle fittings, back off the lock nut until washer (A) bottoms out at top of groove (B) in fitting.
- Hand-tighten fitting until back up washer (A) or washer face (if straight fitting) bottoms on part face (C), and O-ring is seated.
- Position angle fittings by unscrewing no more than one turn.
- Tighten straight fittings to torque shown.
- Tighten angle fittings to torque shown in the following table, while holding body of fitting with a wrench.

SAE NO.	THD SIZE (in.)	NUT SIZE ACROSS FLATS (in.)	TORQUE VALUE*		RECOMMENDED TURNS TO TIGHTEN (AFTER FINGER TIGHTENING)	
			ft-lbf	N·m	Flats	Turns
3	3/8	1/2	6	8	2	1/3
4	7/16	9/16	9	12	2	1/3
5	1/2	5/8	12	16	2	1/3
6	9/16	11/16	18	24	2	1/3
8	3/4	7/8	34	46	2	1/3
10	7/8	1	46	62	1-1/2	1/4
12	1-1/16	1-1/4	75	102	1	1/6
14	1-3/16	1-3/8	90	122	1	1/6
16	1-5/16	1-1/2	105	142	3/4	1/8
20	1-5/8	1-7/8	140	190	3/4	1/8
24	1-7/8	2-1/8	160	217	1/2	1/12

\* Torque values shown are based on lubricated connections as in re-assembly.

## MAINTENANCE AND SERVICING

### 7.3.1.5 O-Ring Face Seal (ORFS) Hydraulic Fittings

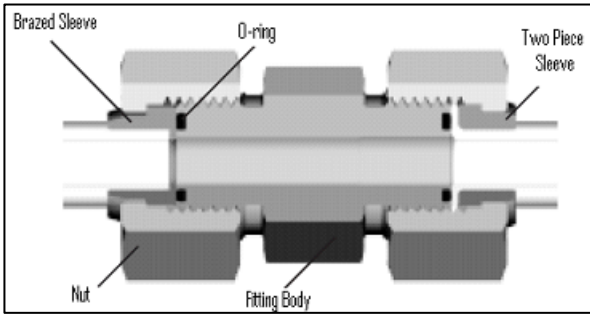
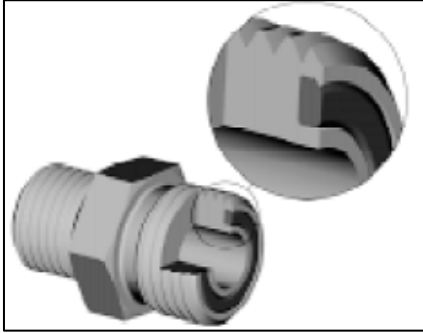

- a. Check components to ensure that the sealing surfaces and fitting threads are free of burrs, nicks, and scratches, or any foreign material.
- b. Apply lubricant (typically Petroleum Jelly) to O-ring and threads. If O-ring is not already installed, install O-ring. Align the tube or hose assembly.
- c. Ensure that flat face of the mating flange comes in full contact with O-ring.
- d. Thread tube or hose nut until hand-tight. The nut should turn freely until it is bottomed out. Torque fitting further to the specified number of F.F.F.T (“Flats From Finger Tight”), or to a given torque value in the table shown in the opposite column.

**NOTE**

*If available, always hold the hex on the fitting body to prevent unwanted rotation of fitting body and hose when tightening the fitting nut.*

- e. When assembling unions or two hoses together, three wrenches will be required.

SAE NO.	THD SIZE (in.)	TUBE O.D. (in.)	TORQUE VALUE*		RECOMMENDED TURNS TO TIGHTEN (AFTER FINGER TIGHTENING)**	
			ft·lbf	N·m	Tube Nuts	Swivel & Hose
3	***	3/16	---	---	---	---
4	9/16	1/4	11 - 12	14 - 16	1/4 - 1/2	1/2 - 3/4
5	***	5/16	---	---	---	---
6	11/16	3/8	18 - 20	24 - 27	1/4 - 1/2	1/2 - 3/4
8	13/16	1/2	32 - 35	43 - 47		
10	1	5/8	45 - 51	60 - 68		
12	1-3/16	3/4	67 - 71	90 - 95		1/3 - 1/2
14	1-3/16	7/8	67 - 71	90 - 95		
16	1-7/16	1	93 - 100	125 - 135		
20	1-11/16	1-1/4	126 - 141	170 - 190		
24	2	1-1/2	148 - 167	200 - 225		
32	2-1/2	2	---	---	---	---

\* Torque values and angles shown are based on lubricated connection, as in re-assembly.

\*\* Always default to the torque value for evaluation of adequate torque.

\*\*\* O-ring face seal type end not defined for this tube size.

## MAINTENANCE AND SERVICING

### 7.3.2 Recommended Fuel, Fluids And Lubricants

#### 7.3.2.1 Fuel

Use good quality diesel fuel in your vehicle from a reputable supplier. For most year-round service, No. 2 diesel fuel meeting ASTM specification D-975 Grade S15 will provide good performance.

If the vehicle is exposed to extreme cold (below 20°F or -7°C), or is required to operate at colder-than-normal conditions for prolonged periods, use climatized No. 2 diesel fuel, or dilute the No. 2 diesel fuel with 50% No. 1 diesel fuel. This will provide better protection from fuel gelling or wax-plugging of the fuel filters.

In extreme situations, when available fuels are of poor quality or problems exist which are peculiar to certain operations, additives can be used. However, the engine manufacturer recommends consultation with the fuel supplier or engine manufacturer prior to use of fuel additives. Among the situations where additives can prove useful are the following:

- A cetane improver additive can be used with low cetane fuels.
- A wax crystal modifier can help with fuels with high cold filter plugging points (CFPP).
- An anti-icer can help prevent ice formation in wet fuel during cold weather.
- An anti-oxidant or storage stability additive can help with fuel system deposits and poor storage stability.
- A lubricity enhancer can be used to increase the lubricity of fuels so that they meet the requirements given in the table on the previous page.

Diesel fuel conditioner is available from your Dealer. Refer to your engine manual for further information on fuel recommendations.

#### 7.3.2.2 Fluids

FLUID	SPEC	DESCRIPTION	USE
<b>Anti-Freeze</b>	ASTM D-4985	Ethylene Glycol With SCA	Equal Parts With Water* Engine Coolant.
<b>Air Conditioning Refrigerant</b>	R134A	Refrigerant	Cab Air Conditioning System.
<b>Air Conditioning Compressor Oil</b>	SP-15 PAG	Compressor Oil	Cab Air Conditioning Compressor Lubricant.

\* High quality, soft, de-ionized or distilled water as recommended by supplier.

#### 7.3.2.3 Lubricants

LUBRICANT	SPEC / DESCRIPTION	USE
<b>Grease</b>	SAE Multi-Purpose. High Temperature Extreme Pressure (EP2) Performance With 1% Max Molybdenum Disulphide (NLGI Grade 2) Lithium Base.	As Required Unless Otherwise Specified.
<b>Engine Oil</b>	SAE 15W-40 Compliant With SAE Specs For API Class SJ and CH-4 Engine Oil.	Engine Crankcase
<b>Hydraulic Oil</b>	SAE 15W-40 Compliant With SAE Specs For API Class SJ and CH-4 Engine Oil.	Windrower Drive. Header Drive.
<b>Gear Lubricant</b>	SAE 85W-140 API Service Class GL-5. Extreme Pressure Gear Lubricant.	Drive Wheel Gears <u>Before</u> Initial Change.
	SAE 75W-90 API Service Class GL-5. Fully Synthetic Gear Lubricant (SAE J2360 Preferred).	Gearbox. Drive Wheel Gears <u>After</u> Initial Change.

#### 7.3.2.4 Capacities

ITEM	CAPACITY
<b>Fuel Tank</b>	97 U.S. Gallons (367 liters)
<b>Hydraulic Reservoir</b>	11.5 U.S. Gallons (44 liters)
<b>Gear Box</b>	2.2 U.S. Quarts (2.1 liters)
<b>Drive Wheel</b>	1.5 U.S. Quarts (1.4 liters)
<b>Engine Cooling System</b>	6.3 U.S. Gallons (24 liters)
<b>Engine Crankcase</b>	13.7 U.S. Quarts (13 liters)
<b>Air Cond. Refrigerant</b>	3.6 lb (1.63 kg)
<b>Air Cond. Compressor Oil</b>	8.1 fl. oz. (240 cc)

#### 7.3.2.5 Storage

Your machine can operate at top efficiency only if clean fuel and lubricants are used.

- Use clean containers to handle all fuels and lubricants.
- Store in an area protected from dust, moisture, and other contaminants.
- Buy good quality, clean fuel from a reputable Dealer.
- Avoid storing fuel over long periods of time. If you have a slow turnover of fuel in windrower tank or supply tank, add fuel conditioner to avoid condensation problems.
- Store fuel in a convenient place away from buildings.

## MAINTENANCE AND SERVICING

### 7.3.3 Conversion Chart

QUANTITY	INCH-POUND UNITS		FACTOR	SI UNITS (METRIC)	
	UNIT NAME	ABBR.		UNIT NAME	ABBR.
<b>Area</b>	acres	acres	x 0.4047 =	hectares	ha
<b>Flow</b>	gallons per minute (US) gallons per minute (Imp)	gpm (US) gpm	x 3.7854 = x 4.5460 =	liters per minute	L/min
<b>Force</b>	pounds force	lbf	x 4.4482 =	Newtons	N
<b>Length</b>	inch	in.	x 25.4 =	millimeters	mm
	foot	ft	x 0.305 =	meters	m
<b>Power</b>	horsepower	hp	x 0.7457 =	kilowatts	kW
<b>Pressure</b>	pounds per square inch	psi	x 6.8948 =	kilopascals	kPa
			x .00689 =	megapascals	MPa
<b>Torque</b>	pound feet or foot pounds	lbf-ft or ft-lbf	x 1.3558 =	newton meters	N·m
	pound inches or inch pounds	lbf-in. or in-lbf	x 0.1129 =		
<b>Temperature</b>	degrees Fahrenheit	°F	(°F - 32) x 0.56 =	Celsius	°C
<b>Velocity</b>	feet per minute	ft/min	x 0.3048 =	meters per minute	m/min
	feet per second	ft/s	x 0.3048 =	meters per second	m/s
	miles per hour	mph	x 1.6063 =	kilometers per hour	km/h
<b>Volume</b>	ounces	oz.	x 29.5735 =	milliliters	ml
	cubic inches	in. <sup>3</sup>	x 16.3871 =	cubic centimeters	cm <sup>3</sup> or cc
	quarts (US) quarts (Imperial)	US qt. qt.	x 0.96464 x 1.1365	liters	L
	gallons (US) gallons (Imperial)	US gal. gal.	x 3.7854 = x 4.5460 =		
<b>Weight</b>	pounds	lb	x 0.4536 =	kilograms	kg

## MAINTENANCE AND SERVICING

### 7.4 MAINTENANCE REQUIREMENTS

Periodic maintenance requirements are organized by service intervals.

Regular maintenance is the best insurance against early wear and untimely breakdowns. Following this schedule will increase machine life.

For detailed instructions, refer to the specific headings in this section. Use the fluids and lubricants specified in Section 7.3.2 *Recommended Fuel, Fluids and Lubricants*.

Log hours of operation, and use the Maintenance Record on the next page to keep a record of scheduled maintenance. You will want to make copies of the Maintenance Schedule / Record page (Section 7.4.1) for this purpose.

Where a service interval is given in more than one time frame, e.g. "100 hours or Annually", service the machine at whichever interval is reached first.

#### **IMPORTANT**

Recommended intervals are for average conditions. Service the machine more often if operated under adverse conditions (severe dust, extra heavy loads, etc.).



#### **CAUTION**

**Carefully follow safety messages given in Section 7.1 PREPARATION FOR SERVICING and Section 7.2 RECOMMENDED SAFETY PROCEDURES.**

# MAINTENANCE AND SERVICING

## 7.4.1 Maintenance Schedule / Record

**M105 Windrower Serial Number:** \_\_\_\_\_

Combine this page with the record in the Header Operator's Manual.  
Copy this page to continue the record.

ACTION:		✓ - Check	◆ - Lubricate	▲ - Change	✱ - Clean	+ - Add																																			
<b>MAINTENANCE RECORD</b>	<b>Hour Meter Reading</b>																																								
	<b>Date</b>																																								
	<b>Serviced By</b>																																								
<b>FIRST USE</b>		Refer to Section 7.4.2 <i>Break-In Inspections.</i>																																							
<b>ANNUALLY *</b>		Also See Section 7.4.3 <i>Pre-Season/Annual Service.</i>																																							
✓	A/C Blower	5.10.1																																							
✓	Anti-Freeze Concentration	7.8.7																																							
✓	Battery Charge	7.10.1																																							
✓	Battery Fluid Level	7.10.1																																							
▲	Fuel Tank Vent Line Filter	7.8.6																																							
✓	Steering Linkages	7.7.4																																							
<b>END OF SEASON</b>		Refer to Section 7.4.4 <i>End of Season Service.</i>																																							
<b>10 HOURS OR DAILY</b>		<b>NOTE: A RECORD OF DAILY MAINTENANCE IS NOT NORMALLY REQUIRED BUT IS AT THE OWNER/OPERATOR'S DISCRETION.</b>																																							
✱	A/C Condenser																					7.9.3																			
✱	Charge Air Cooler																					7.9.3																			
✓	Engine Oil Level																					7.8.3																			
✓	Engine Coolant Level																					7.8.7																			
✓	Fuel Tank																					7.8.6.3																			
✓	Fuel Filter Water Trap																					7.8.6.4																			
✓	Hydraulic Hoses and Lines																					7.11.6																			
✱	Hydraulic Oil Cooler																					7.9.3																			
✓	Hydraulic Oil Level																					7.11.1																			
✱	Radiator	7.9.3																																							
✓	Tire Inflation	7.12.1																																							
<b>50 HOURS</b>																																									
✱	Cab Fresh Air Intake Filter	7.7.6																																							
◆	Caster Pivots	7.4.5																																							
◆	Forked Caster Spindle Bearings	7.4.5																																							
✓	Gear Box Oil Level	7.8.8																																							
◆	Top Lift Link Pivots	7.4.5																																							
◆	Walking Beam Center Pivot	7.4.5																																							
<b>100 HOURS OR ANNUALLY *</b>																																									
✱	Cab Air Return Filter	7.7.6																																							

*(continued next page)*



## MAINTENANCE AND SERVICING

ACTION:		✓ - Check	⬇ - Lubricate	▲ - Change	* - Clean	+ - Add																
<b>MAINTENANCE RECORD</b>	<b>Hour Meter Reading</b>																					
	<b>Date</b>																					
	<b>Serviced By</b>																					
<b>250 HOURS OR ANNUALLY *</b>																						
▲	Engine Air Filter Primary Element ** 7.8.5																					
▲	Engine Oil and Filter 7.8.4																					
⬇	Formed Caster Wheel Hub Bearings 7.4.5																					
✓	Drive Wheel Lubricant 7.12.1.3																					
✓	Wheel Nut Torque 7.12.1.2 / 7.12.2.3																					
<b>500 HOURS</b>																						
▲	Engine Oil and Filter (or Annually) 7.8.4																					
▲	Fuel Filters 7.8.6.2																					
▲	Gearbox Lubricant 7.8.8.2																					
▲	Hydraulic Oil Filters 7.11.3																					
✓	Safety Systems (or Annually) 7.7.2																					
<b>1000 HOURS</b>																						
▲	Drive Wheel Lubricant 7.12.1.3																					
<b>1500 HOURS OR BI-ANNUALLY *</b>																						
▲	Hydraulic Oil 7.11.2																					
<b>2000 HOURS OR BI-ANNUALLY *</b>																						
▲	Engine Coolant 7.8.7.3																					
✓	General Inspection 7.8.1																					
<b>5000 HOURS OR BI-ANNUALLY *</b>																						
✓	Engine Valve Tappet Clearance 7.8.1																					

\* **WHICHEVER OCCURS FIRST. IT IS RECOMMENDED THAT ANNUAL MAINTENANCE BE DONE PRIOR TO START OF OPERATING SEASON.**

\*\* CDM displays **ENGINE AIR FILTER**.

## MAINTENANCE AND SERVICING

### 7.4.2 Break-In Inspections

	ITEM	REFER TO SECTION
<b>Every 1/4 Hour Road or 1 Hour Field</b>	Check Drive Wheel Nut Torque - 220 ft·lbf (300 N·m). Repeat Checks Until Torque Stabilizes.	7.12.1.2
<b>At 5 Hours</b>	Check A/C Belt Tension.	7.8.10.1
	Check Caster Wheel Nut Torque - 120 ft·lbf (163 N·m).	7.12.2.3
	Check Caster Wheel Anti-Shimmy Dampener Bolt Torque. Inboard Bolts - 100 ft·lbf (135 N·m). Outboard Bolts - 85 ft·lbf (115 N·m).	7.12.2.6
	Check Walking Beam Width Adjustment Bolts Torque - 330 ft·lbf (448 N·m).	6.3.6
<b>At 10 Hours</b>	Check Walking Beam Width Adjustment Bolts Torque - 330 ft·lbf (448 N·m).	6.3.6
	Check Drive Wheel Nut Torque - 220 ft·lbf (300 N·m). Repeat Checks Until Torque Stabilizes, <u>and</u> At 20 Hours and 30 Hours.	7.12.1.2
	Check NEUTRAL Adjustment.	See Dealer.
<b>At 50 Hours</b>	Check Hose Clamps - Air Intake / Radiator / Heater / Hydraulic. Hand-tighten unless otherwise noted.	Various
	Check Walking Beam Width Adjustment Bolts Torque - 330 ft·lbf (448 N·m).	6.3.6
	Check Caster Wheel Anti-Shimmy Dampener Bolt Torque. Inboard Bolts - 100 ft·lbf (135 N·m). Outboard Bolts - 85 ft·lbf (115 N·m).	7.12.2.6
	Check Drive Wheel Nut Torque - 220 ft·lbf (300 N·m). Repeat Checks Until Torque Stabilizes.	7.12.1.2
	Change Drive Wheel Lubricant.	7.12.1.3
	Change Main Gearbox Oil.	7.8.8.2
	Change Hydraulic Oil Filters.	7.11.3

## MAINTENANCE AND SERVICING

### 7.4.3 Pre-Season/Annual Service

- a. Perform the following at the beginning of each operating season:



### CAUTION

- Review the Operator's Manual to refresh your memory on safety and operating recommendations.
  - Review all safety signs and other decals on the header and note hazard areas.
  - Be sure all shields and guards are properly installed and secured. Never alter or remove safety equipment.
  - Be sure you understand and have practiced safe use of all controls. Know the capacity and operating characteristics of the machine.
  - Check the first aid kit and fire extinguisher. Know where they are and how to use them.
- b. Perform the following checks:
1. Drain off excess hydraulic oil added for storage. Refer to Section 7.11.2 *Changing Hydraulic Oil*.
  2. Remove plastic bags and/or tape from all sealed openings (air cleaner intake, exhaust pipe, fuel tank).
  3. Charge battery and install. Be sure terminals are clean, and cables are connected securely.
  4. Adjust tension on A/C compressor belt. See Section 7.8.10.1 Tension.
  5. Check the entire air conditioning system for leakage at the beginning of each season.

6. Cycle A/C switch to distribute A/C refrigerant oil as follows:

### IMPORTANT

Perform the following steps whenever the machine is first started after storage for more than one week:

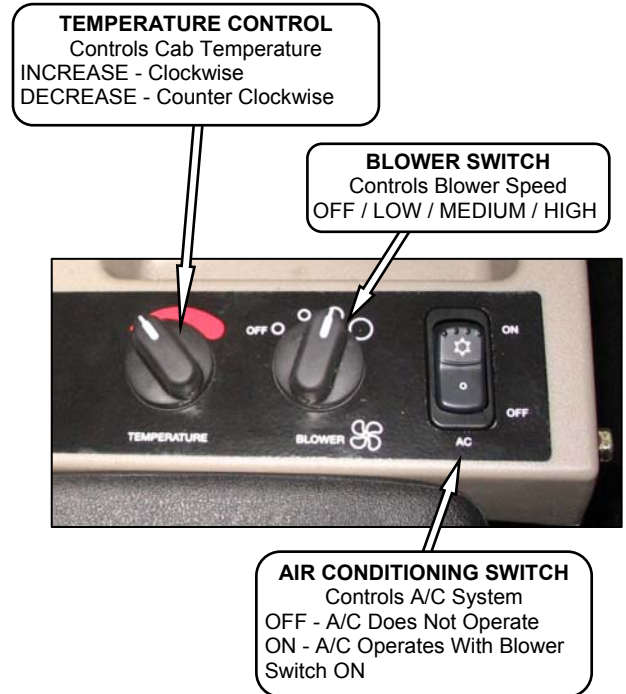

- i. Turn blower switch to first position, turn temperature control switch to MAXIMUM heating, and A/C control to OFF.
  - ii. Start engine, and operate at low idle until engine is warm.
  - iii. Click A/C switch from OFF to ON for one second, then back to OFF for 5 to 10 seconds. Repeat this step ten times.
- c. Perform annual maintenance. See Section 7.4 MAINTENANCE REQUIREMENTS.

## MAINTENANCE AND SERVICING

### 7.4.4 End of Season Service

Perform the following at the end of each operating season:

- a. Clean the machine thoroughly.



### CAUTION

**Never use gasoline, naphtha or any volatile material for cleaning purposes. These materials may be toxic and/or flammable.**

- b. Store in a dry, protected place if possible. If stored outside, always cover with a waterproof canvas or other protective material.
- c. Raise header, and engage header lift cylinder lock-outs.
- d. If possible, block up the header.
- e. Re-paint all worn or chipped painted surfaces to prevent rust.
- f. Loosen drive belts.
- g. Lubricate the header thoroughly, leaving excess grease on fittings to keep moisture out of bearings. Apply grease to exposed threads, cylinder rods, and sliding surfaces of components. Oil cutterbar components to prevent rust.
- h. Check for worn components, and repair as necessary.
- i. Check for broken components and order replacements from your MacDon Dealer. Attention to these items right away will save time and effort at beginning of next season.
- j. Replace or tighten any missing or loose hardware. Refer to Section 7.3.1 *Recommended Torques*.
- k. Remove tall crop dividers (if equipped) to reduce space required for inside storage.

### 7.4.5 Lubrication



### WARNING

**To avoid personal injury, before servicing windrower or opening drive covers, follow procedures in Section 7.1 PREPARATION FOR SERVICING.**

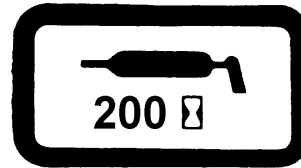

The greasing points are marked on the machine by decals showing a grease gun and grease interval in hours of operation.

#### 7.4.5.1 Greasing Procedure



### DANGER

**Stop engine, and remove key from ignition before leaving Operator's seat for any reason. A child or even a pet could engage an idling machine.**

- a. Use the recommended lubricants specified in this manual. See Section 7.3.2 *Recommended Fuel, Fluids and Lubricants*.
- b. Wipe grease fitting with a clean cloth before greasing, to avoid injecting dirt and grit.
- c. Inject grease through fitting with grease gun until grease overflows fitting, except where noted.
- d. Leave excess grease on fitting to keep out dirt.
- e. Replace any loose or broken fittings immediately.
- f. If fitting will not take grease, remove and clean thoroughly. Also clean lubricant passageway. Replace fitting if necessary.
- g. Refer to the illustrations on the following pages to identify the various locations that require lubrication, organized by the frequency of service that is required.

# MAINTENANCE AND SERVICING

## EVERY 50 HOURS

High Temperature Extreme Pressure (EP2) Performance With 1% Max Molybdenum Disulphide (NLGI Grade 2). Lithium Base.

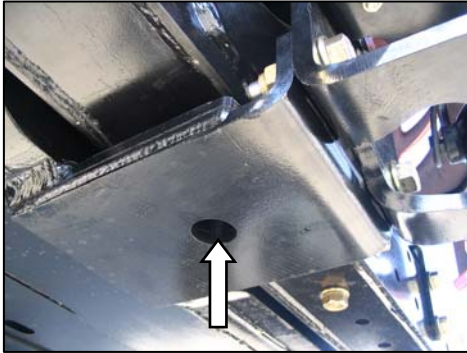

WALKING BEAM PIVOT

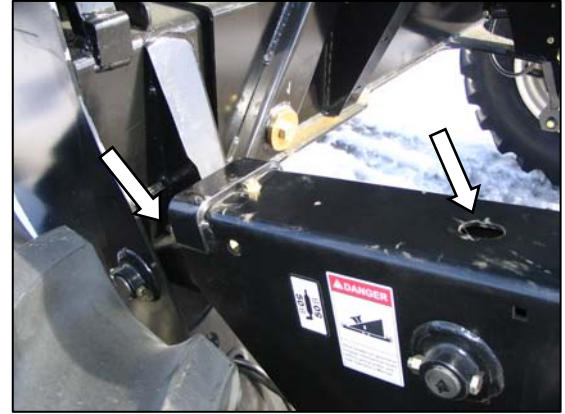

TOP LINK - TWO FITTINGS (BOTH SIDES)

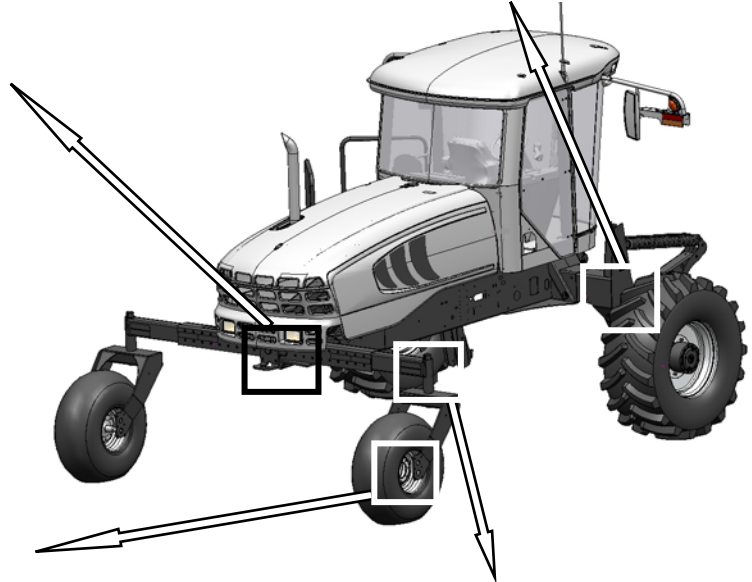

FORKED CASTER SPINDLE BEARINGS  
TWO PLACES (BOTH WHEELS)



CASTER PIVOT  
(BOTH SIDES)

## MAINTENANCE AND SERVICING

### EVERY 250 HOURS

High Temperature Extreme Pressure  
(EP2) Performance With 1% Max  
Molybdenum Disulphide  
(NLGI Grade 2). Lithium Base.



FORMED CASTER WHEEL BEARING  
1 PLACE (BOTH WHEELS)

## MAINTENANCE AND SERVICING

### 7.5 ENGINE COMPARTMENT HOOD

The engine hood has two open positions:

- The **lowest** is for general maintenance such as checking and adding fluid, servicing the cooling box, etc.
- The **highest** accommodates full access to the engine bay

- a. Open the hood at the **lowest position** as follows:

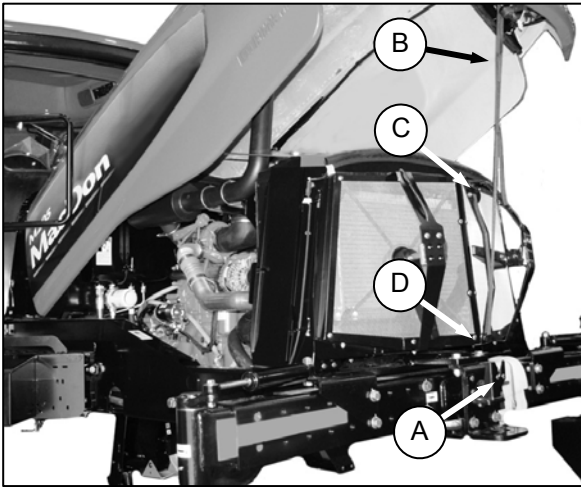

1. Locate latch (A) behind grill, and lift to release hood.
2. Raise hood until strap (B), which should be looped under hooks (C) and (D), stops it at approximately a 40° angle.
3. Remove strap from hook (C), and allow hood to raise slightly further.

- b. To close hood:

1. Grasp the strap at (B), and loop under upper hook (C).

#### IMPORTANT

Failure to hook strap may result in it becoming entangled with the screen cleaners or the latch.

2. Pull down on strap (B), grasp the hood when within reach, and lower until hood engages latch (A).

- c. Open the hood at the **highest position** as follows:

1. Open hood to lowest position.

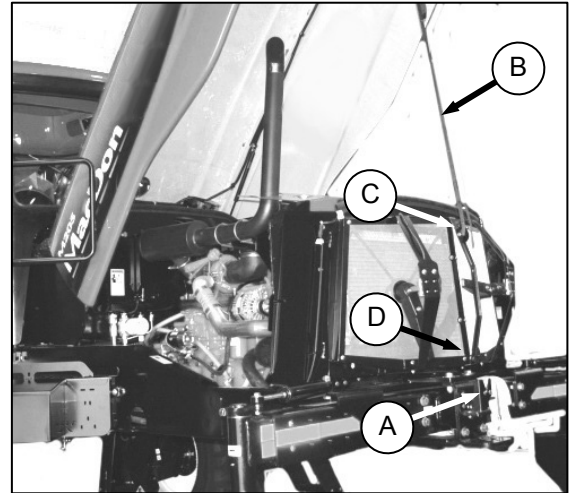

2. Remove strap from hooks (C) and (D), and allow hood to raise fully to approximately 65° angle.

- d. To close hood:

1. Grasp the strap at (B), and loop under upper hook (C).
2. Pull down on strap, and loop under lower hook (D).

#### IMPORTANT

Failure to hook strap may result in it becoming entangled with the screen cleaners or the latch.

3. Pull down on strap, grasp the hood when within reach, and lower until hood engages latch (A).

## MAINTENANCE AND SERVICING

### 7.6 MAINTENANCE PLATFORM

A swing away platform/stair is provided for access to the Operator's station and engine bay maintenance.

#### 7.6.1 Opening/Closing Platform

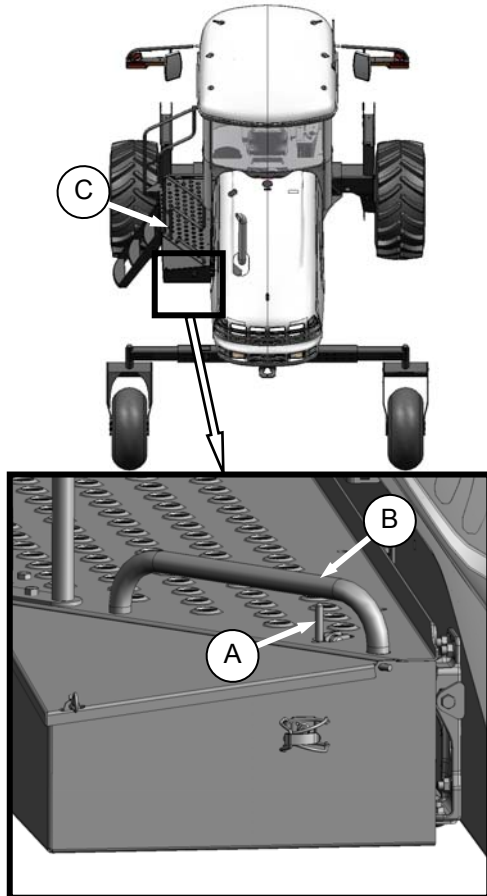

- Push latch (A) inward, grasp handle (B), and pull platform (C) toward walking beam until it stops, and latch re-engages.
- To move platform back to closed position, release latch (A), and move platform forward until it stops, and latch re-engages.

#### 7.6.2 Opening/Closing Platform for Major Servicing

To improve access to the hydraulics plumbing, the platform can be swung away from the windrower.

- Open engine compartment hood to lowest position.

#### IMPORTANT

Failure to open hood will result in damage to the hood when the platform is re-positioned.

- Unlock latch (A), and move platform (C) aft, but do not lock.

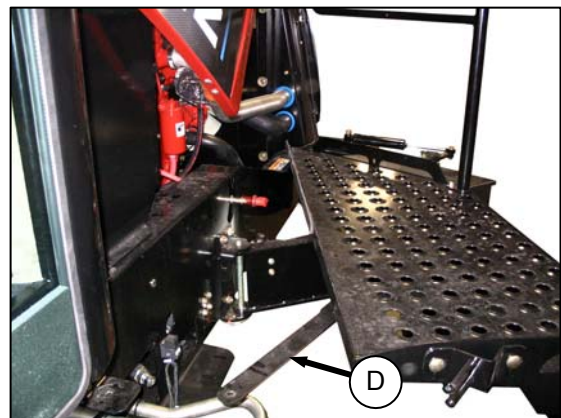

- Remove nut and bolt at frame, and swing link (D) clear of valve block.

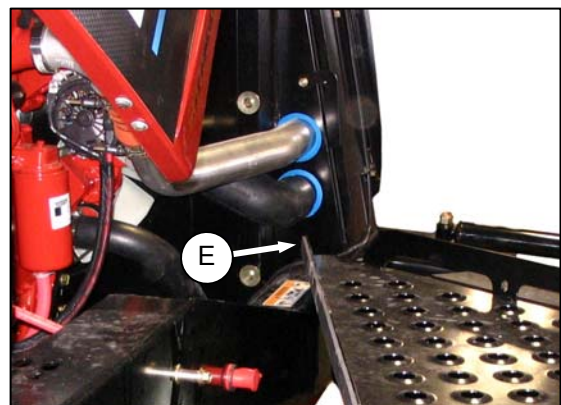

- At the same time, pull front end of platform away from frame, while moving it towards the walking beam. Aft corner (E) of platform should project slightly into engine bay when optimum opening is reached.

*(continued next page)*



## MAINTENANCE AND SERVICING



### CAUTION

Do **not** stand on the platform in the unlocked position. It is unstable and may result in a fall.

- e. Close platform as follows:

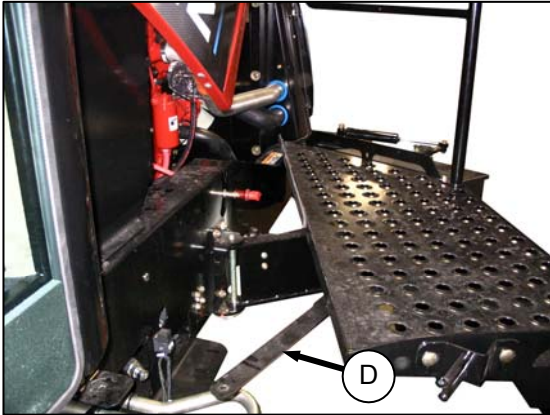

1. Swing link (D) all the way forward.
  2. Move platform front end inboard while moving it away from the walking beam.
  3. Position link (D) on bracket, and install bolt and nut. Tighten just enough so that link can still swivel on bracket.
  4. Close platform, ensuring it is locked.
- f. Close engine compartment hood.

## MAINTENANCE AND SERVICING

### 7.7 OPERATOR'S STATION

#### 7.7.1 Seat Belts

- a. Keep sharp edges and items that can cause damage away from the belts.
- b. From time to time, check belts, buckles, retractors, tethers, slack take-up system and mounting bolts for damage.
- c. Replace all parts that have damage or wear.
- d. Replace belts that have cuts that can weaken the belt.
- e. Check that bolts are tight on the seat bracket or mounting.
- f. Keep seat belts clean and dry. Clean only with a soap solution and warm water. DO **NOT** use bleach or dye on the belts, as this may weaken the material.

#### 7.7.2 Safety Systems

Perform the following checks on the Operator's presence and engine lock-out systems annually, or every 500 hours - whichever occurs first.

##### 7.7.2.1 Operator's Presence System

- a. With the windrower engine running, place the GSL in NEUTRAL, and turn the steering wheel until it locks.
- b. With everyone clear of the machine, engage HEADER DRIVE switch:
  1. After header drives are running, stand up out of the seat. In approximately 5 seconds the header should shut off.
  2. If not, the Operator Presence System requires adjustment. See your Dealer.

##### NOTE

*To restart the header, move the HEADER DRIVE switch to OFF, and then to ON.*

- c. With the windrower moving at less than 5 mph (8 km/h):
  1. Stand up out of the seat.
  2. The CDM will flash "NO OPERATOR" on the upper line, and "ENGINE SHUT DOWN 5...4...3...2...1...0" on the lower line accompanied by a steady tone. At "0", the engine shuts down.
  3. If the engine does not shut down, the Operator Presence System requires adjustment. See your Dealer.

- d. With the windrower moving at more than 5 mph (8 km/h):
  1. Stand up out of the seat.
  2. The CDM beeps once and displays "NO OPERATOR" on the lower line.
  3. If not, the Operator Presence System requires adjustment. See your Dealer.

##### 7.7.2.2 Engine Interlock

- a. With the engine shut down and the HEADER DRIVE switch engaged, try to start the engine. If the engine turns over, the system requires adjustment. See your Dealer.
- b. With the engine shut down, steering wheel not centered, and the GSL in NEUTRAL but not in N-DETENT, try to start the engine. The CDM will flash "NOT IN NEUTRAL" on the display upper line, and "CENTER STEERING WHEEL" on the lower line, accompanied by a short beep with each flash, and the engine should not turn over. If the engine turns over, the system requires adjustment. See your Dealer.

A properly functioning system should operate as follows. If not, see your Dealer.

- The starter should engage ONLY when the GSL is in N-DETENT, steering wheel is locked in the CENTER position, and the HEADER DRIVE switch is OFF.
- Under the above conditions, the brake should engage, and the machine should not move after engine start-up.
- The steering wheel should not lock with the engine running, and the GSL out of N-DETENT.
- The machine should not move with the engine running and with the steering wheel still centered, when the GSL is pulled straight out of N-DETENT (not in forward or reverse).

## MAINTENANCE AND SERVICING

### 7.7.3 GSL Adjustments

#### 7.7.3.1 GSL Lateral Movement



### DANGER

Stop engine, and remove key from ignition before leaving Operator's seat for any reason. A child or even a pet could engage an idling machine.

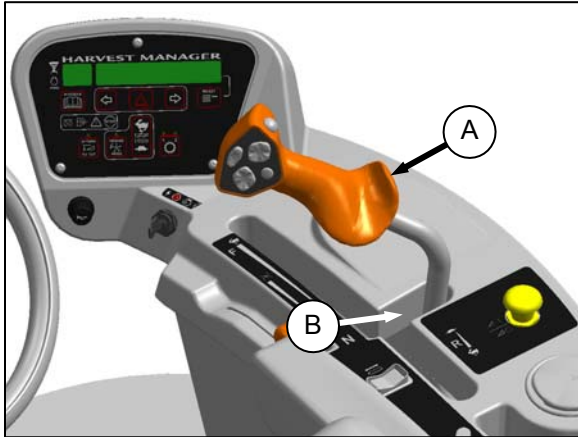

The GSL (A) should easily move into N-DETENT (B) by itself, and the tensioner cable (C) should be tight when the GSL is at the right hand side of the N-DETENT (B).

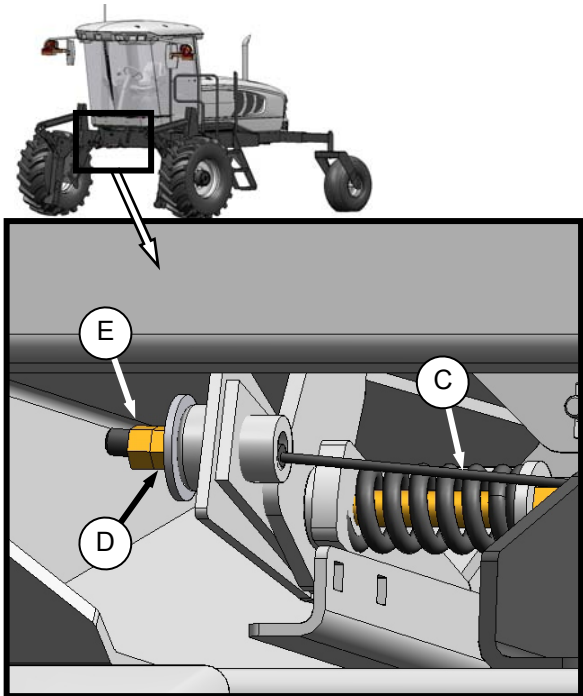

The Neutral Start Switch should also be fully compressed. If the cable is too tight, it will prevent the Neutral Start Switch from fully compressing, and prevent proper engagement of pintle arm.

Adjust the cable tension as follows:

- Hold nut (D) from turning, and loosen jam-nut (E).
- To increase the tension, turn the nut (D) clockwise.
- To decrease the cable tension, turn the nut (D) counter clockwise.
- Hold nut (D) from turning, and tighten jam-nut (E).

#### 7.7.3.2 GSL Fore-Aft Movement

The GSL should remain as positioned by the Operator, and yet can be moved without excessive force. The spring is factory-set to 2.50 in. (64 mm) as shown on the illustration below.

If necessary, adjust as follows:

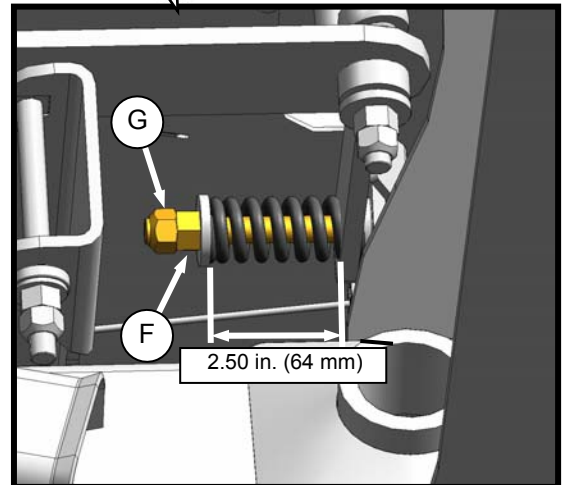

- Hold nut (F) from turning, and loosen jam-nut (G).
- To increase the pivot resistance, turn the nut (F) clockwise to compress the spring.
- To decrease the resistance, turn the nut (F) counter clockwise to release the spring tension.
- Hold nut (F) from turning, and tighten jam-nut (G).

## MAINTENANCE AND SERVICING

### 7.7.3.3 GSL Position



The GSL should be centered fore-aft (A) in the N-DETENT slot when the steering wheel is centered and locked.

If necessary, adjust as follows:

#### **IMPORTANT**

Neutral Interlock must be properly adjusted before adjusting GSL position.

- a. Lock pintle arms.

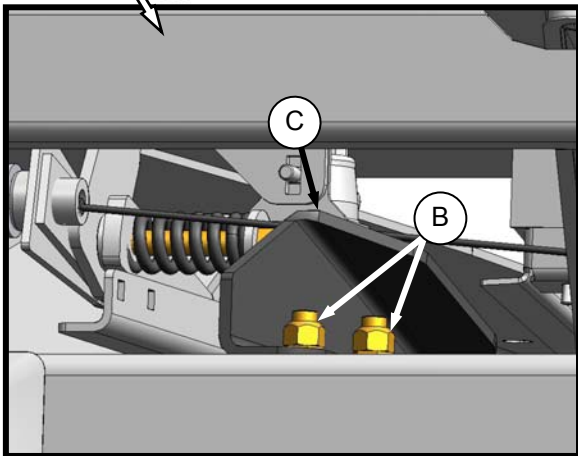
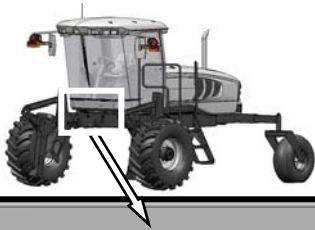

- b. Loosen nuts (B).
- c. Hold GSL in center of N-DETENT slot to locate support (C).
- d. Tighten nuts (B), and torque to 80 - 90 ft·lbf (108 - 122 Nm).

## MAINTENANCE AND SERVICING

### 7.7.4 Steering Adjustments

#### 7.7.4.1 Steering Link Pivots

Perform the following checks annually:



### DANGER

Stop engine, and remove key from ignition before leaving Operator's seat for any reason. A child or even a pet could engage an idling machine.

- Place GSL in N-DETENT. Shut down engine, and remove key.



- Check under the cab for evidence of interference of moving parts with hoses, tubes, other linkages.

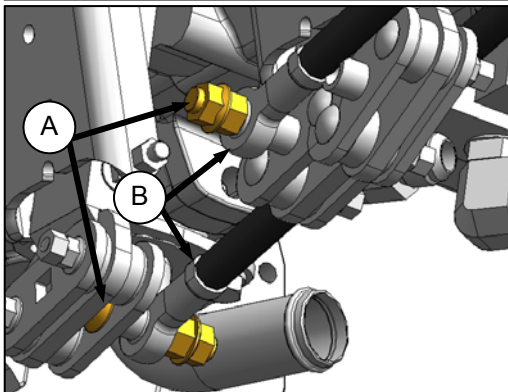
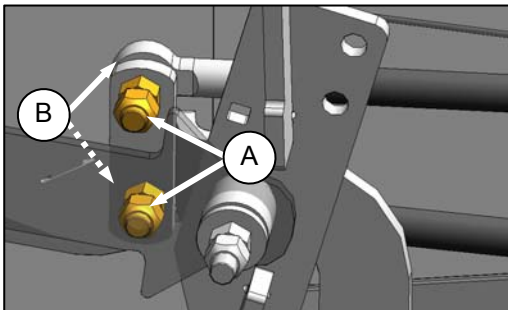

- Check steering rod bolts (A) for looseness, and ball joints (B) for any perceptible play or movement.

- If steering rod bolts (A) are loose:

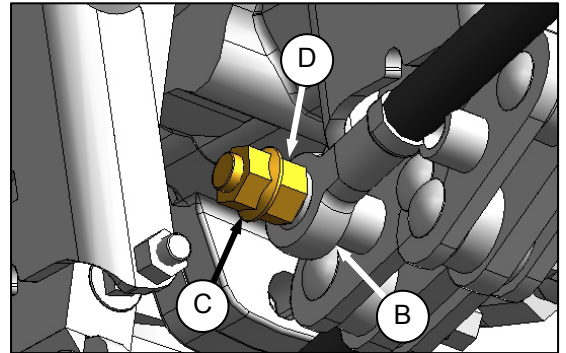

- Back off outer jam-nut (C).
  - Tighten inside nut (D) to 70 - 80 ft-lbf (95 - 108 N·m).
  - Hold inside nut (D), and tighten jam-nut (C) to 60 - 70 ft-lbf (81 - 95 N·m).
- If steering rod ball joints (B) are loose, they should be replaced. See your Dealer, or refer to the Technical Service Manual for replacement procedures.

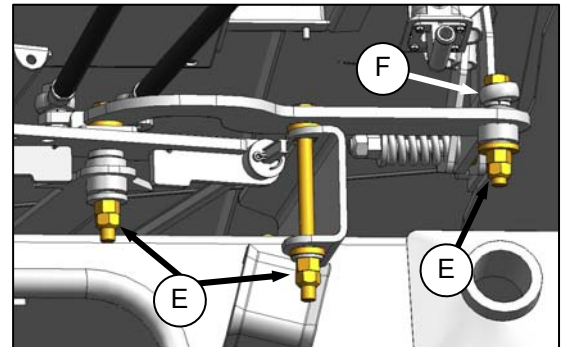

- Check steering link bolts (E) for looseness, and ball joint (F) for any perceptible play or movement.

*(continued next page)*

## MAINTENANCE AND SERVICING

- g. If steering link bolts (E) are loose:

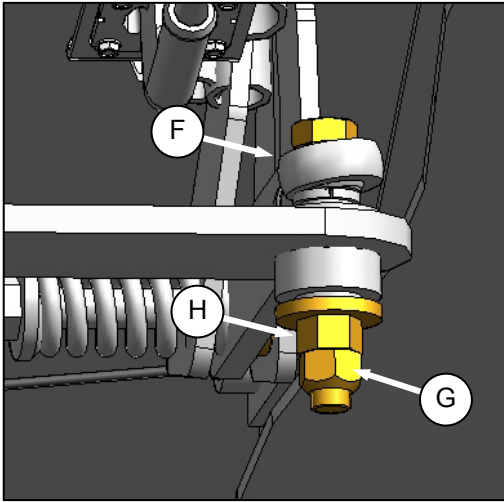

1. Back off outer jam-nut (G).
  2. Tighten inside nut (H) to 5 - 10 ft·lbf (7 - 13 N·m).
  3. Hold inside nut (H), and tighten jam-nut (G) to 60 - 70 ft·lbf (81 - 95 N·m).
- h. If steering link ball joint (F) are loose, they should be replaced. See your Dealer or refer to the Technical Service Manual for replacement procedures.
- i. After replacing parts or making adjustments, perform checks for neutral interlock and steering lock. Refer to Section 7.7.2. *Safety Systems*.

### 7.7.5 Neutral Start Switch

The Neutral Start Switch (A) must be closed before the engine can be started.

The switch is closed when the Neutral Interlock on the pump is activated by positioning the GSL into N-DETENT, and locking the steering wheel in CENTER position.

When the switch closes, and the machine starts and runs, the brakes continue to be applied to the drive wheels as park brake solenoid 3 is energized preventing brake release.

The Neutral Start Switch is located on the frame adjacent to the hydrostatic transmission.

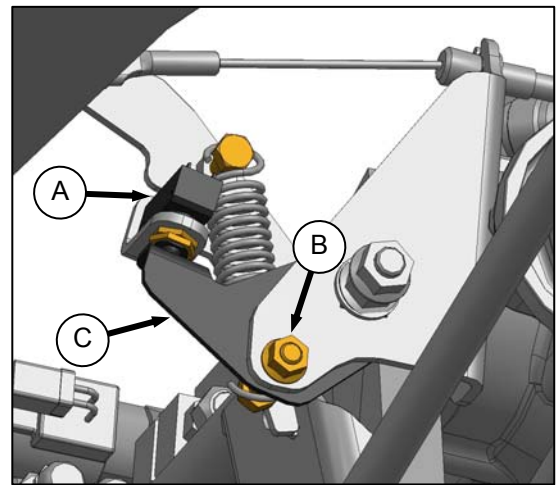

- a. Check that electrical connections are good at Neutral Start Switch (A).
- b. Check that the plunger of switch is fully compressed when the steering is locked, and the GSL is fully in N-DETENT. Adjust switch support if required as follows:
  1. Loosen nut (B), and adjust support (C) as required.
  2. Tighten nut (B).

#### **IMPORTANT**

Do not over-adjust switch support, as this will prevent pintle arms from locking.

## MAINTENANCE AND SERVICING

### 7.7.6 HVAC System

#### 7.7.6.1 Fresh Air Intake Filter

The fresh air filter is located under the cab roof behind the rear window, and should be serviced daily.

Service the filter as follows:



### DANGER

**Stop engine, and remove key from ignition before leaving Operator's seat for any reason. A child or even a pet could engage an idling machine.**

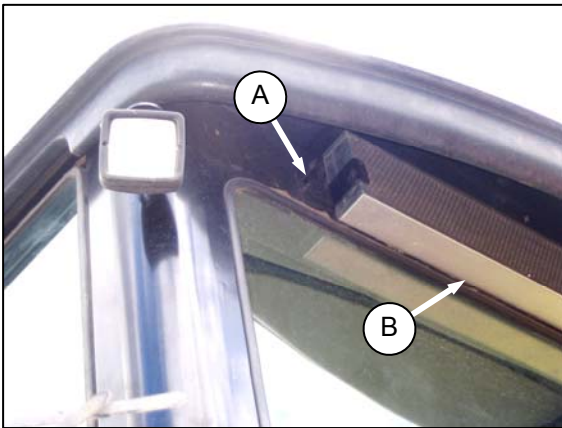

- a. Loosen knob (A), and slide retainer out to release filter (B) from rear of cab roof.



CLEANING AIR FILTER

- b. Tap filter gently on a flat surface, dirty side down. Do not tap on a tire, treads may damage filter pleats.

- c. Direct compressed air (100 psi (700 kPa) maximum) through filter in opposite direction of air flow arrows.
- d. Wash filter as required:
  1. Soak 15 minutes in warm water (not over 100°F (40°C)) with Filter Element Cleaner (Donaldson D 1400 or equivalent).
  2. Rinse thoroughly with clean water (maximum pressure 40 psi (275 kPa)).
  3. Shake excessive water from filter, and allow element to dry. Do not use compressed air to dry filter as it may rupture the wet element. Protect element from freezing until dry.
- e. Inspect filter before installing as follows:
  1. Hold a bright light on one side element, and check carefully for holes. Discard any element which shows the slightest hole.
  2. Be sure outer screen is not dented. Vibration would quickly wear a hole in the filter.
  3. Be sure filter gasket is in good condition. If gasket is damaged or missing, replace element
- f. Re-install filter, making sure air flow arrows point towards cab.

## MAINTENANCE AND SERVICING

### 7.7.6.2 Return Air Filter

The return air filter is located behind the Operator's seat on the cab wall, and should be serviced every 100 hours as follows:



### DANGER

**Stop engine, and remove key from ignition before leaving Operator's seat for any reason. A child or even a pet could engage an idling machine.**

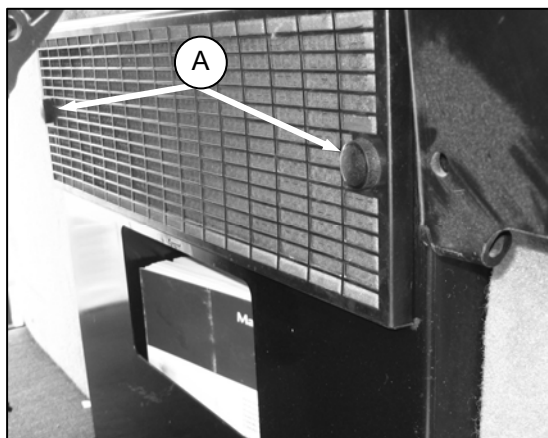

- a. Unscrew the two knobs (A) attaching cover and filter to cab wall, and pull off the cover and filter assembly.

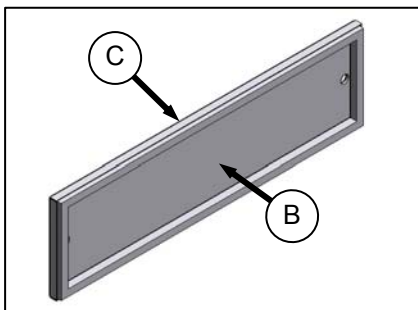

- b. Separate the filter (B) from the cover (C).
- c. Clean the filter as follows:
  1. Mix a solution of warm water and detergent in a suitable container so that the filter can soak for a few minutes.
  2. Agitate to flush out the dirt.
  3. Rinse with clean water, and dry with compressed air.
  4. Inspect filter for damage, separation, and holes. Replace if damaged.
- d. Assemble the filter (B) and cover (C), and position on cab wall over opening.
- e. Secure to cab wall with knobs (A).

### 7.7.6.3 A/C Condenser

The air conditioning condenser should be cleaned daily with compressed air, and more frequent cleaning may be necessary in severe conditions.

Cleaning the condenser can be done at the same time as the radiator, oil cooler, and charge air cooler. Refer to Section 7.9.3 *Cooling Box Maintenance*.

### 7.7.6.4 A/C Evaporator

The air conditioning evaporator should be checked annually for cleanliness. If the air conditioning system produces insufficient cooling, a possible cause is clogged evaporator fins. Fins will clog up from the side opposite the blowers.

The evaporator is located inside the heating air conditioning unit under the cab.

To clean the evaporator, proceed as follows:



### DANGER

**Stop engine, and remove key from ignition before leaving Operator's seat for any reason. A child or even a pet could engage an idling machine**

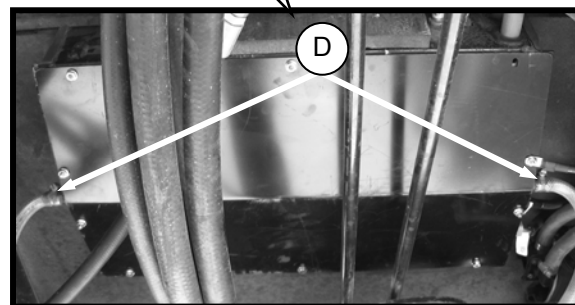

- a. Loosen the clamps (D) on the two drain hoses, and pull the hoses off the air conditioning drain tubes.

*(continued next page)*



## MAINTENANCE AND SERVICING

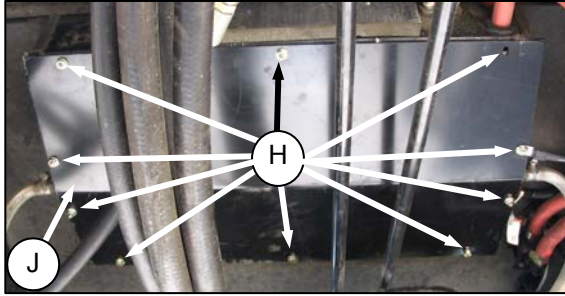

- b. Remove the ten fasteners (H) that attach the cover (J), and remove the cover.



### WARNING

To avoid cuts from evaporator fins, do **not** use bare hands to brush away clogs.

- c. Use a vacuum or compressed air to remove dirt from inside the unit.

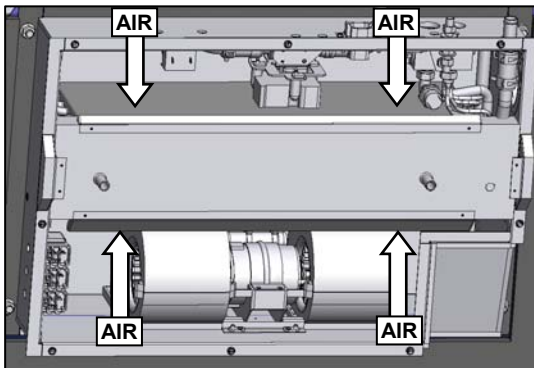

- d. Blow compressed air through the evaporator fins from the blower side first (as shown). Direct the air straight into the evaporator to prevent fin damage. A nozzle extension would make this procedure easier.
- e. Repeat the previous step from the side opposite the blowers.
- f. If dirt is still present, soak evaporator in water to loosen dirt, and then blow out with compressed air.
- g. Straighten any bent fins.
- h. Re-position cover (J), and attach with ten fasteners (H).
- i. Re-attach drain hoses to drain tubes, and secure with hose clamps (D).

### 7.7.6.5 A/C Compressor Protection

The compressor is protected from excessively low and high pressures by two switches that shut down the compressor to prevent damage to the system.

These switches do **not** require any regular servicing or maintenance, so if problems occur and the switches are suspect, contact your Dealer.

### 7.7.6.6 Compressor Servicing

- a. Refer to Section 7.8.10.2 A/C Compressor Belt Replacement for belt replacement procedures.
- b. See your MacDon Dealer or your Technical Service Manual for all other servicing procedures

## MAINTENANCE AND SERVICING

### 7.8 ENGINE



#### CAUTION

- Never operate engine in a closed building. Proper ventilation is required to avoid exhaust gas hazards.
- Keep the engine clean. Straw and chaff on a hot engine are a fire hazard.
- Never use gasoline, naphtha or any other volatile material for cleaning purposes. These materials are toxic and/or flammable.

#### 7.8.1 General Engine Inspection

Engine inspection should be performed by your MacDon Dealer.

Refer to your Engine Manual for further information. (Owner's Manual QSB4.5 and QSB6.7 Engine Cummins # 4021531 supplied with your machine).

#### 7.8.2 Manually Turning Engine

To manually turn the engine with the flywheel, an access hole is provided on the left front side for a barring tool that is available from Cummins.

Manually turn engine as follows:

#### IMPORTANT

Ensure nothing falls into gearbox oil reservoir.



#### DANGER

**Stop engine, and remove key from ignition before leaving Operator's seat for any reason. A child or even a pet could engage an idling machine.**

- Remove key from ignition.
- Open engine compartment hood to lowest position. See Section 7.5 ENGINE COMPARTMENT HOOD.

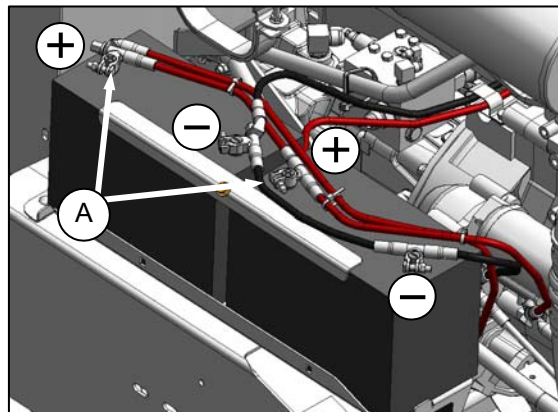

- Remove red plastic covers (A) from positive cable clamps. Loosen clamps, and remove cable from batteries.

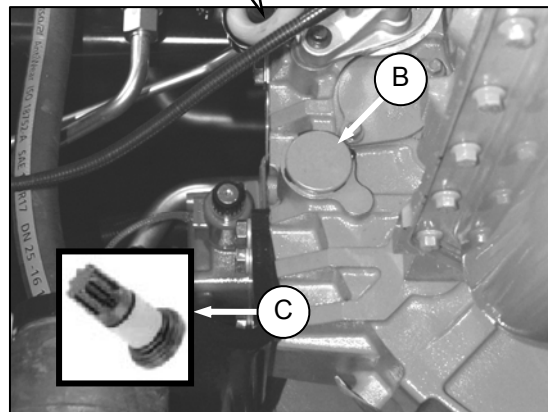

- Clean area around the plastic cap on access hole (B). Remove the cap.
- Insert the tool (C) into the flywheel housing until it engages the ring gear.
- Attach a 1/2 inch square drive ratchet or breaker bar, and turn.
- Remove barring tool (C), and clean oil from around access hole.
- Clean plastic cap, and re-install in hole with silicone sealant.
- Reconnect the battery.
- Close hood.

## MAINTENANCE AND SERVICING

### 7.8.3 Oil Level

Check engine oil level frequently, and watch for any signs of leakage.

#### NOTE

*During the break-in period, a higher than usual oil consumption should be considered normal.*

Check the oil level as follows:

- Stop engine, and remove key. Wait about 5 minutes.
- Open engine compartment hood to lowest position. See Section 7.5 ENGINE COMPARTMENT HOOD.

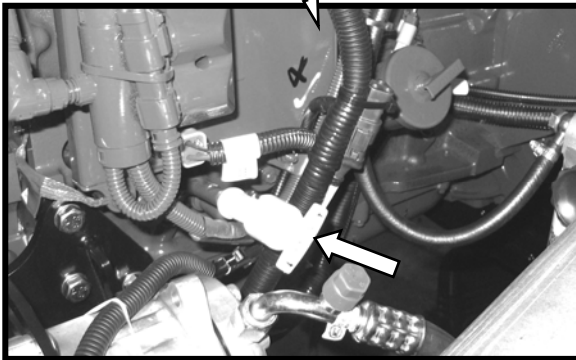

- Remove dipstick by turning it counter clockwise to unlock, and remove.
- Wipe clean, re-insert in engine, and remove.

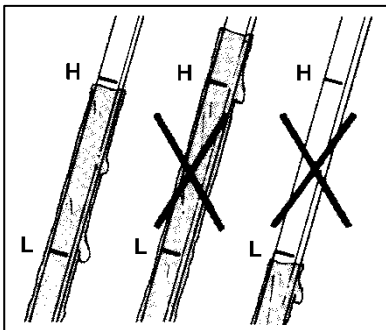

- Oil level should be between LOW and HIGH marks.
- Replace dipstick, and turn it clockwise to lock.

- Add oil as follows if level is below the LOW mark: One U.S. qt. (1 liter) will raise the level from LOW to HIGH.



#### CAUTION

Do not fill above the HIGH mark.



- Turn handle (B) counter clockwise to loosen bung, and remove cap (A).
  - Carefully pour the oil. Use SAE 15W-40 Compliant With SAE Specs for API Class SJ and CH-4 Engine Oil. A funnel is recommended to avoid spillage.
  - Replace oil filler cap, and turn handle (B) clockwise until snug.
- Close engine compartment hood.

## MAINTENANCE AND SERVICING

### 7.8.4 Changing Oil and Oil Filter

#### NOTE

The engine should be warm prior to changing the oil.

- Stop engine, and remove key.
- Place a drain pan of about 6 U.S. gallons (24 liters) under engine oil drain.

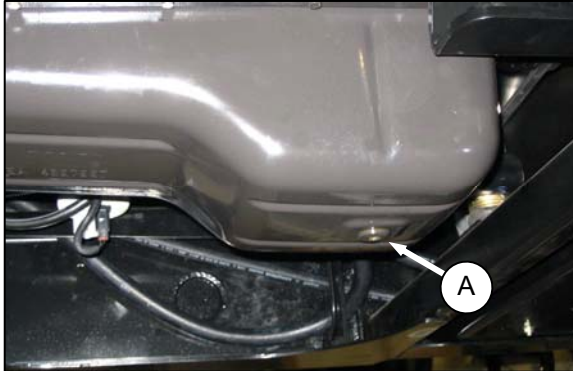

- Remove oil pan drain plug (A), and allow oil to completely finish draining.
- Check the condition of used oil. If either of the following is evident, have your Dealer correct the problem before starting the engine:
  - Thin black oil indicates fuel dilution.
  - Milky discoloration indicates coolant dilution.
- Open engine compartment hood to lowest position. See Section 7.5 ENGINE COMPARTMENT HOOD.

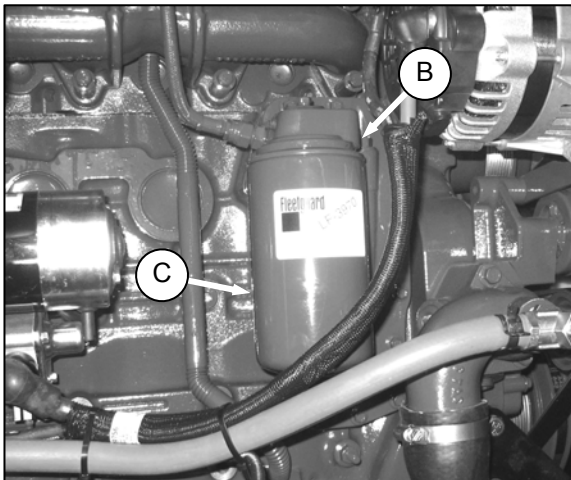

- Clean around the filter head (B).
- Remove filter (C).
- Clean gasket mating surface.
- Apply a thin film of clean oil to the gasket on the new filter.

- Screw the new filter onto the filter mount until the gasket contacts the filter head.
- Tighten the filter an additional 1/2 to 3/4 turn by hand.

#### IMPORTANT

Do not use a filter wrench to install the oil filter. Over-tightening can damage the gasket and filter.

- Install the oil pan drain plug (A).

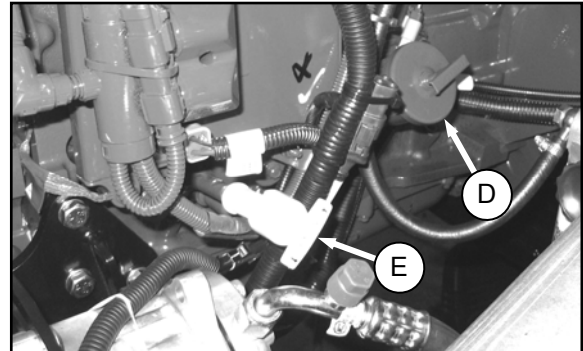

- Remove oil filler pipe cap (D), and add engine oil. The engine requires 13.7 U.S. quarts (13 liters) of SAE 15W40 Compliant with SAE Specs for API Class SJ and CH-4 Engine Oil.
- Replace filler cap (D).
- Operate the engine at low idle, and check for leaks at the filter and drain plug.
- Stop the engine, wait 5 minutes, and check the oil level with dipstick (E). Add or remove oil to bring oil to HIGH level mark on dipstick.
- Close engine compartment hood.
- Properly dispose of used oil and filter.

## MAINTENANCE AND SERVICING

### 7.8.5 Air Intake System

#### IMPORTANT

Do not run engine with air cleaner disconnected or disassembled.

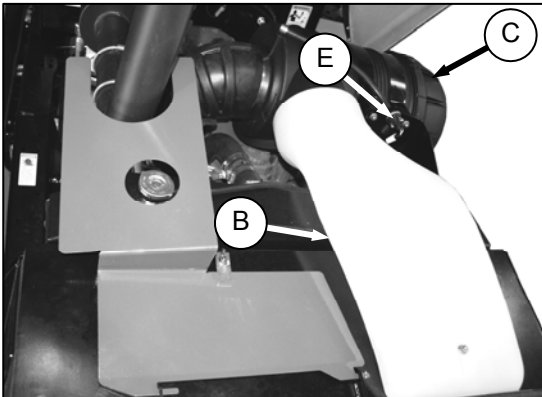
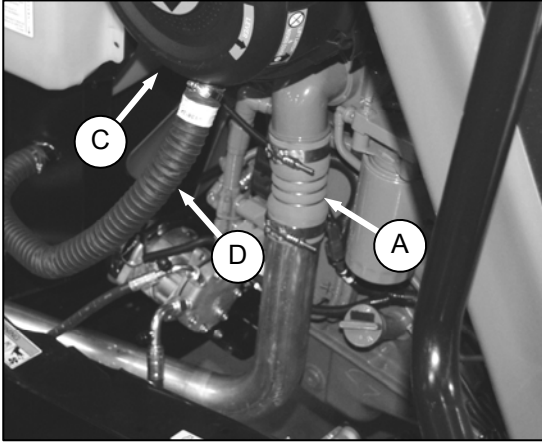

Engine intake air (A) is drawn through a duct (B) from the cooling box that pre-cleans the air, and then through a dual element filter (C).

The air cleaner canister is equipped with an aspirator (D) that removes dust continuously from the air cleaner housing.

The air cleaner is also equipped with a restriction switch (E) which activates a warning display and tone on the CDM when the filter system requires servicing.

#### IMPORTANT

Filter servicing should only be performed when the CDM indicates "ENGINE AIR FILTER" or at the specified interval. Refer to Section 7.4.1 *Maintenance Schedule / Report*.

#### IMPORTANT

Over-servicing the filter element increases the risk of dirt being ingested by the engine, and severely damaging the engine.

### 7.8.5.1 Air Filter Servicing



#### DANGER

Stop engine, and remove key from ignition before leaving Operator's seat for any reason. A child or even a pet could engage an idling machine.

- Open engine compartment hood to highest position. See Section 7.5 ENGINE COMPARTMENT HOOD.

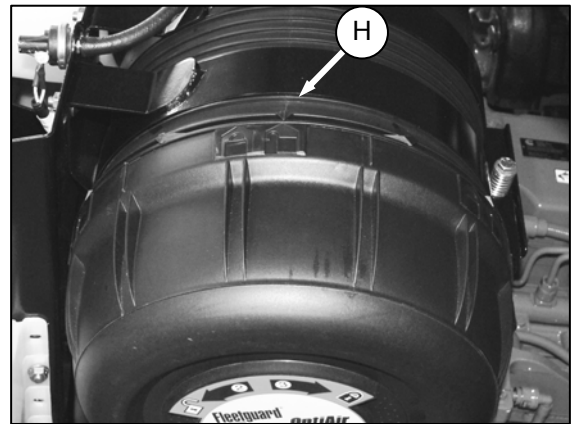
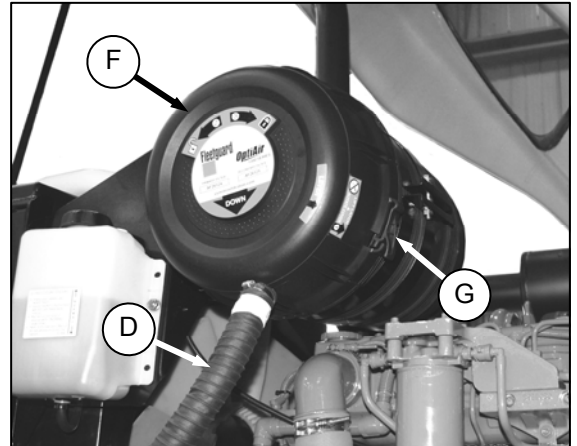

- Slightly lift catch (G) at side of end cap (F), and rotate end cap counter clockwise until it stops, and arrow (H) lines-up with UNLOCK symbol on end cap.
- Pull off the end cap.

*(continued next page)*

## MAINTENANCE AND SERVICING

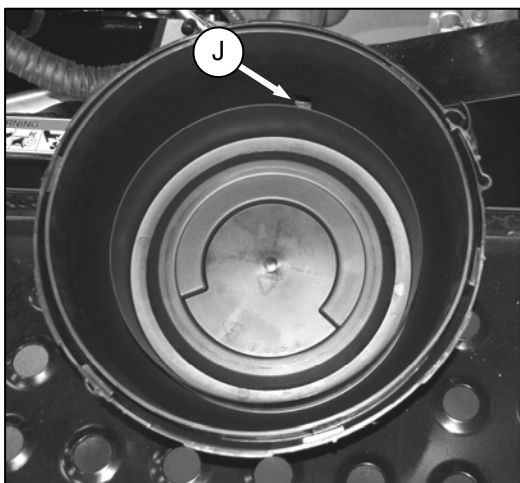

- d. Check aspirator duct opening (J) for obstructions or damage. Clean if necessary.

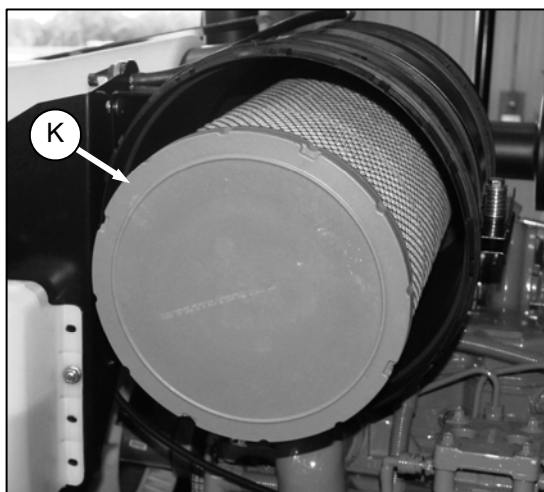

- e. Pull out primary filter element (K).

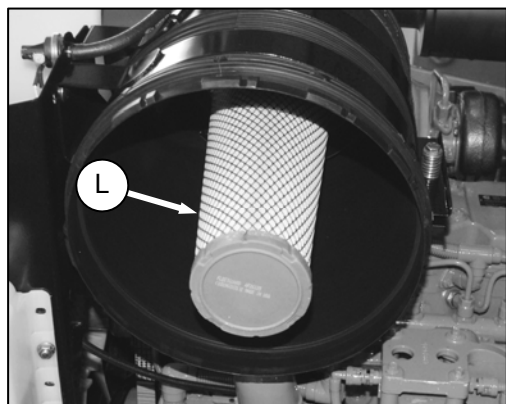

### IMPORTANT

Leave safety element (L) in place to prevent ingress of dirt into engine intake.

- f. Clean inside of canister, and cover with a damp cloth.

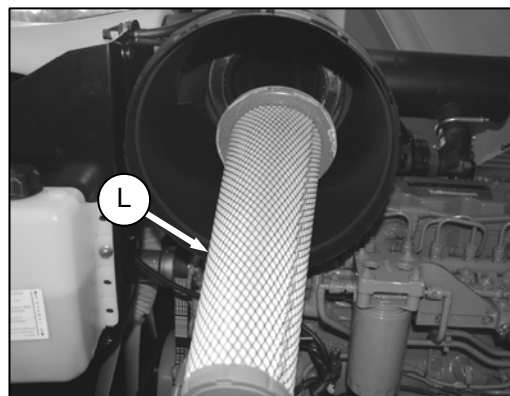

- g. To remove the safety element (L), pull it out of the canister.  
h. Insert new safety filter element (L) into canister, seal first, and push until seal is seated inside canister.

### IMPORTANT

When replacing safety filter, re-insert new filter as soon as possible to prevent dirt from entering engine intake.

- i. Insert new primary filter element (K) into canister over safety element, and push into place, ensuring that element is firmly seated in canister.

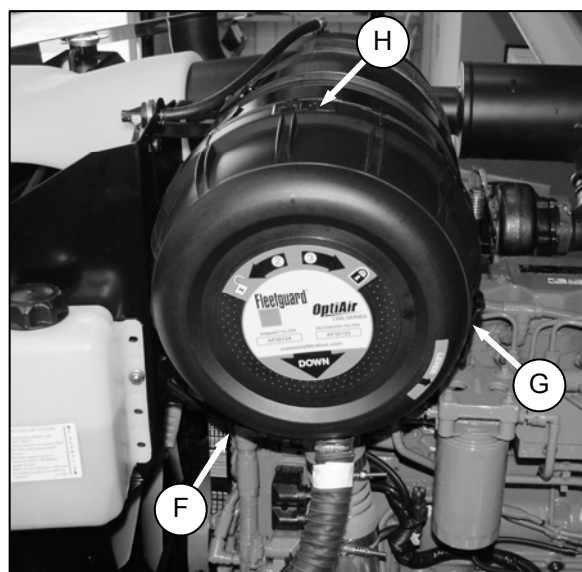

- j. Position end cap (F) onto filter housing with aspirator pointing approximately down.  
k. Align arrow (H) to UNLOCK position on end cap, and push end cap fully onto housing.  
l. Rotate end cap clockwise until catch (G) engages housing to prevent end cap from turning.

*(continued next page)*

## MAINTENANCE AND SERVICING

- m. Inspect the air intake piping for damage, cracked hoses, loose clamps, etc. Repair or replace damaged parts, and tighten loose clamps.

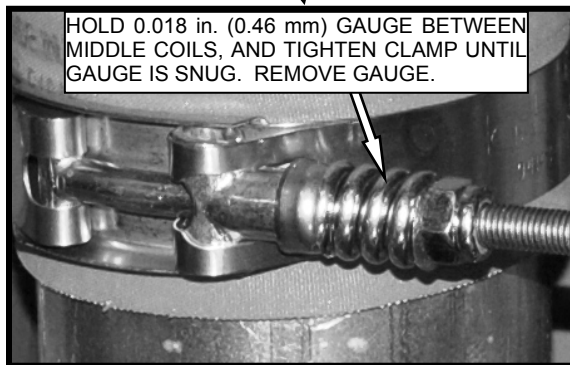
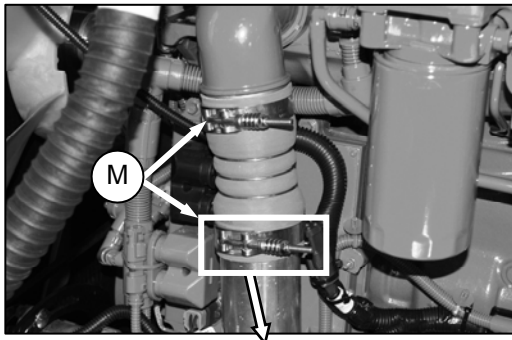
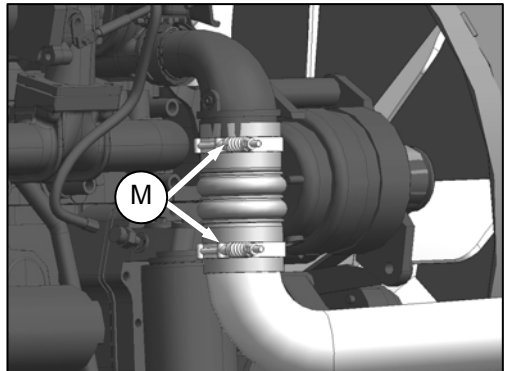
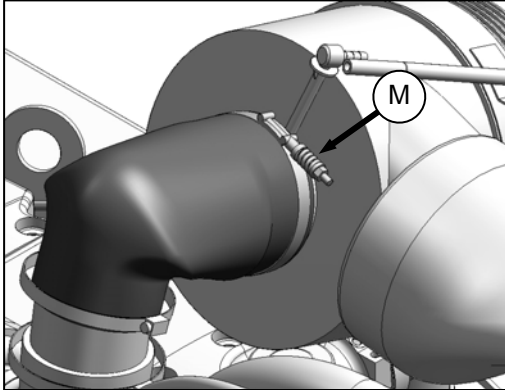

- n. If spring type clamps (M) require tightening, use a gauge as shown.
- o. Close engine compartment hood.

### 7.8.5.2 Filter Element Cleaning

#### IMPORTANT

Air filter element cleaning is not recommended due to the possible degradation of the element material.

If cleaning is performed, there are several risks involved, and the following procedures should be followed:

- a. Remove primary filter as described in previous section.
- b. Inspect as follows:
  1. Hold a bright light inside element, and check carefully for holes. Discard any element which shows the slightest hole.
  2. Be sure outer screen is not dented. Vibration would quickly wear a hole in the filter.
  3. Be sure filter gasket is in good condition. If gasket is damaged or missing, replace element.
  4. If element is coated with oil or soot, replace the element.
  5. Check the safety element for cleanliness. If there is visible dirt on the safety element, replace both primary and safety elements.

#### IMPORTANT

The air cleaner's primary (outer) filter element should be replaced after three cleanings or at the specified interval. Refer to Section 7.4.1 *Maintenance Schedule / Report*.

#### IMPORTANT

The safety (inner) element should be replaced every third time the primary element is changed.

- c. Clean element with compressed air, and a Dry Element Cleaner Gun.
- d. Hold nozzle next to inner surface, and move up and down on pleats.

#### IMPORTANT

Air pressure must not exceed 60 psi (400 kPa). Do not direct air against outside of element, as dirt might be forced through to inside.

- e. Repeat inspection before installing.

## MAINTENANCE AND SERVICING

### 7.8.6 Fuel System

#### 7.8.6.2 Fuel Filters

##### 7.8.6.1 Fuel Tank Venting

The fuel tank is vented by a hose that is connected to the filler tube. The hose is connected to a filter that should be changed annually.

Change the filter as follows:



### DANGER

Stop engine, and remove key from ignition before leaving Operator's seat for any reason. A child or even a pet could engage an idling machine.



### WARNING

To avoid personal injury or death from explosion or fire, do not smoke or allow flame or sparks near windrower when servicing.

- Open engine compartment hood to highest position. See Section 7.5 ENGINE COMPARTMENT HOOD.

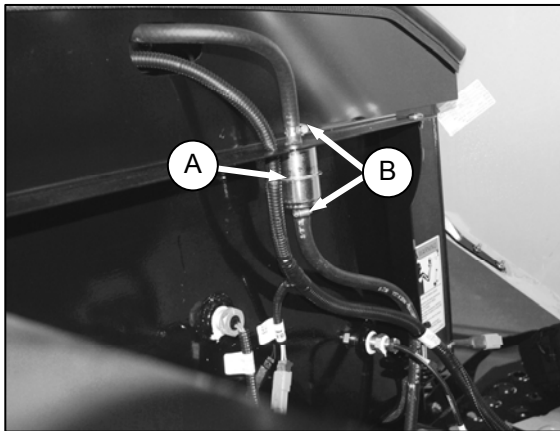

- Locate filter (A) on vent line against hydraulic oil reservoir.
- Release hose tension clamps (B), and slide away from filter. Pull hoses off filter.
- Locate new filter through hole in frame, and attach top hose onto filter. "IN" marking should face down.

### NOTE

*If filter has an arrow instead of an "IN" marking, arrow should point up.*

- Attach lower hose to filter, and secure both hoses with tension clamps (B).

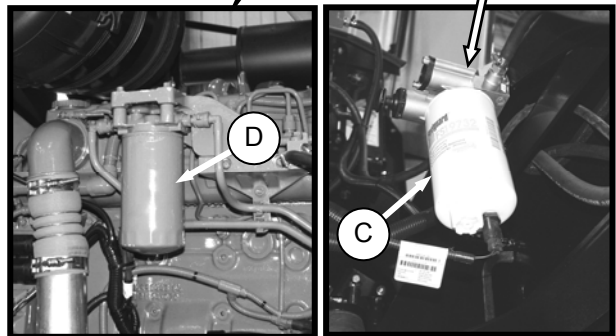
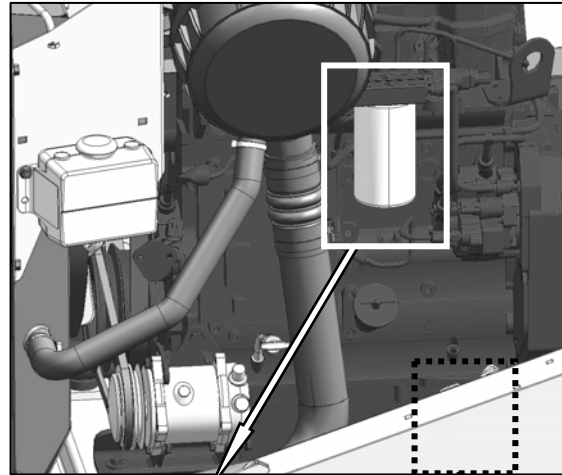

The M105 windrower fuel system is equipped with primary (C) and secondary (D) screw-on cartridge type filters.

The primary (C) filter is equipped with a separator that separates sediment and water from the fuel.

*(continued next page)*



## MAINTENANCE AND SERVICING

Change both filters as follows every 500 hours of operation:

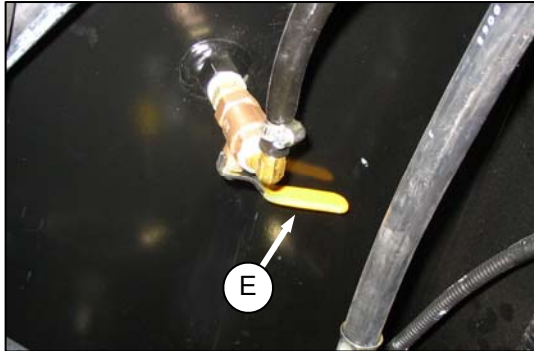

- a. Close fuel supply valve (E) under fuel tank.
- b. Change primary filter (C) as follows:

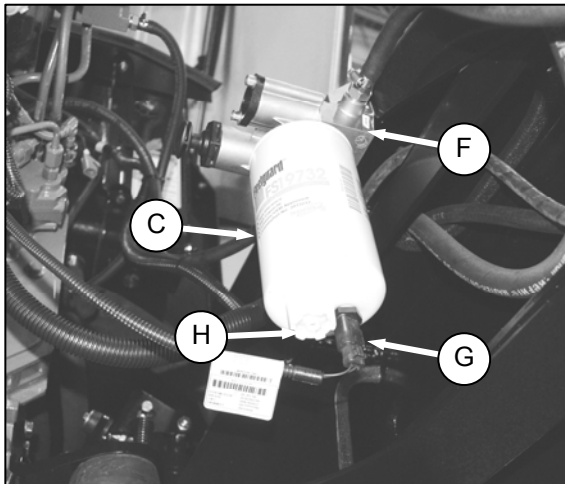

1. Clean around the filter head (F).
2. Disconnect Water In Fuel (WIF) sensor (G) from bottom of filter.
3. Turn drain valve (H) by hand counter clockwise until draining occurs, and drain filter into a container.
4. Remove filter (C) with a filter wrench.
5. Clean gasket mating surface.

### IMPORTANT

Do not pre-fill filter with fuel. Pre-filling can contaminate the fuel system.

6. Screw the new filter (C) onto the filter mount until the gasket contacts the filter head.
7. Reconnect WIF (Water In Fuel) sensor (G).
8. Hand-tighten the filter an additional 1/2 to 3/4 turn.

### IMPORTANT

Do not use a filter wrench to install the filter. Over-tightening can damage the gasket and filter.

- c. Change secondary filter (D) as follows:

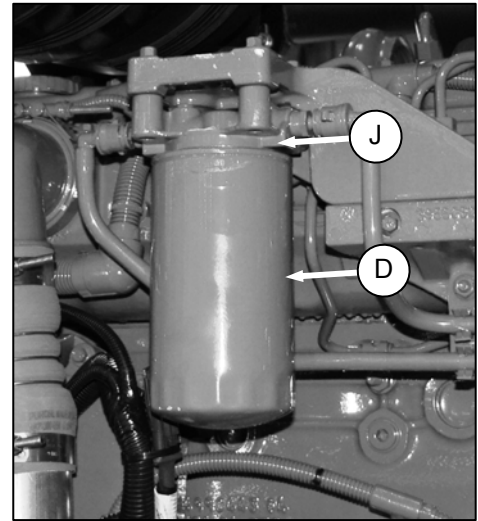

1. Clean around the filter head (J).
2. Place a container under the filter to catch spilled fluid.
3. Remove filter (D) with a filter wrench.
4. Clean gasket mating surface.

### IMPORTANT

Do not pre-fill filter with fuel. Pre-filling can contaminate the fuel system.

5. Screw the new filter onto the filter mount until the gasket contacts the filter head.
6. Hand-tighten the filter an additional 1/2 to 3/4 turn.

### IMPORTANT

Do not use a filter wrench to install the filter. Over-tightening can damage the gasket and filter.

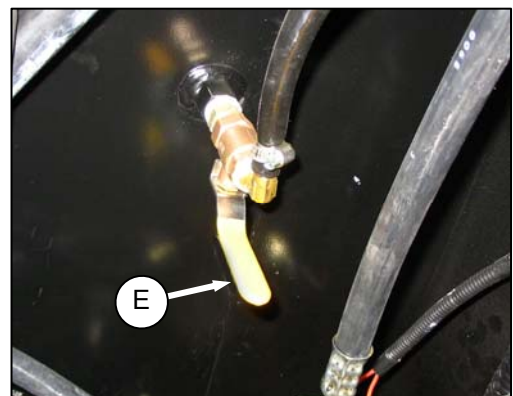

- d. Open fuel valve (E) under fuel tank.
- e. Prime the system. Refer to Section 7.8.6.5 System Priming.
- f. Close engine compartment hood.

## MAINTENANCE AND SERVICING

### 7.8.6.3 Draining Fuel Tank

Draining the fuel tank is necessary to remove old or contaminated fuel.



#### DANGER

Stop engine, and remove key from ignition before leaving Operator's seat for any reason. A child or even a pet could engage an idling machine.



#### WARNING

To avoid personal injury or death from explosion or fire, do not smoke or allow flame or sparks near windrower when servicing.

- Stop engine, and remove key.
- Open engine compartment hood to lowest position. See Section 7.5 ENGINE COMPARTMENT HOOD.

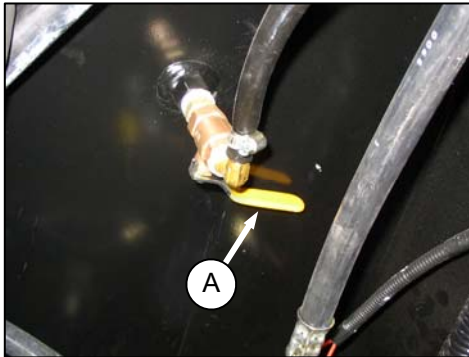

- Close fuel supply valve (A).

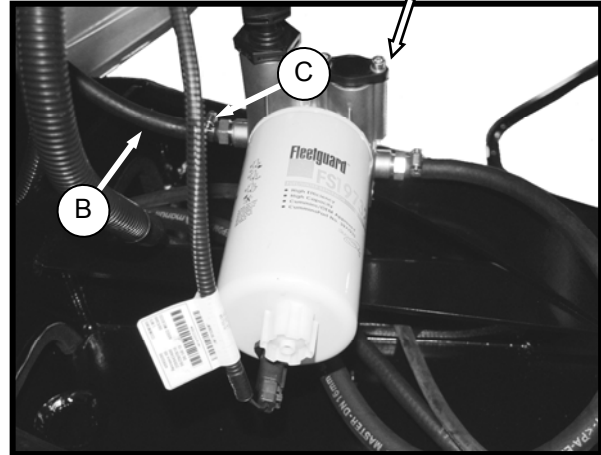
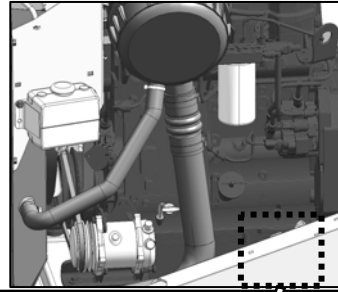

- Place a 5 U.S. gallon (20 liter) drain pan under the fuel supply hose (B) at primary filter.
- Loosen clamp (C), and pull hose (B) off fitting.
- Route hose to drain pan, and open valve (A) to drain tank.
- Add some clean fuel to tank to flush out any remaining contaminants.
- Re-attach hose (B) to fitting. Install clamp (C) and tighten.
- Refill tank.

## MAINTENANCE AND SERVICING

### 7.8.6.4 Separator

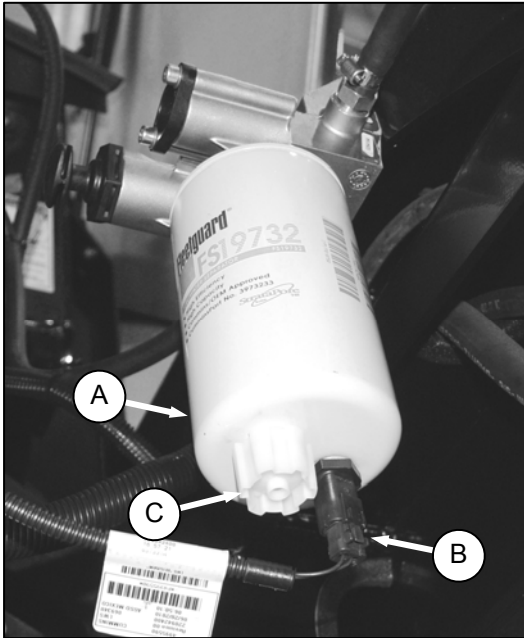

A fuel water separator is incorporated into the primary fuel filter (A).

The separator is equipped with a sensor (B) that detects water in the fuel (WIF) and alerts the Operator on the CDM, and a drain (C).

Drain the water and sediment as follows from the separator daily, or at any time the CDM Water in Fuel (WIF) light illuminates.

- Stop engine, and remove key.
- Place a container under the filter to catch spilled fluid.
- Turn drain valve (C) by hand 1-1/2 to 2 turns counter clockwise until draining occurs.
- Drain the filter sump of water and sediment until clear fuel is visible.
- Turn the valve clockwise to close the drain.
- Dispose of fluid safely.

### 7.8.6.5 System Priming

Controlled venting of air is provided at the injection pump through the fuel drain manifold.

Small amounts of air introduced by changing filters or injection pump supply line will be vented automatically, if the fuel filters are changed in accordance with instructions.



## WARNING

The fuel pump high-pressure fuel lines and fuel rail contain extremely high pressure fuel. Never loosen any fittings. Personal injury and property damage can result.

### IMPORTANT

Bleeding the fuel system is not recommended nor is it required.

Manual priming will be required if:

- The fuel filter is replaced.
- Injection pump is replaced.
- High-pressure fuel lines are replaced.
- Engine is run until fuel tank is empty.

Prime the fuel system as follows:

- Stop engine, and remove key.
- Open engine compartment hood to lowest position. See Section 7.5 ENGINE COMPARTMENT HOOD.

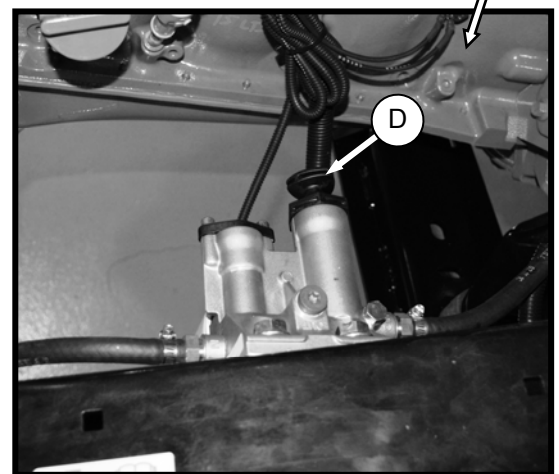
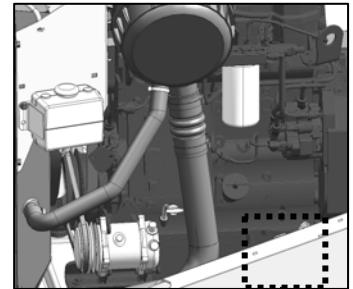

- Turn priming knob (D) counter clockwise to unlock the plunger on the primary filter head.
- Pump approximately 120 times to pressurize the fuel system.
- Lock plunger by turning knob (D) clockwise until snug.
- Try starting the engine. If engine does not start, repeat priming.

## MAINTENANCE AND SERVICING

### 7.8.7 Engine Cooling System

The engine cooling system is designed to maintain the engine operating temperature within the specified operating range.

#### NOTE

*Anti-freeze is essential in any climate. It broadens the operating temperature range by lowering the coolant freezing point, and by raising its boiling point. Anti-freeze also contains rust inhibitors and other additives to prolong engine life.*

#### IMPORTANT

If anti-freeze strength is not adequate, do not drain cooling system to protect against freezing. System may not drain completely, and damage from freezing could still result.

To service the cooling system, perform the following:



### DANGER

**Stop engine, and remove key from ignition before leaving Operator's seat for any reason. A child or even a pet could engage an idling machine.**

- Stop engine, and remove key.
- Raise engine compartment hood to lowest position. See Section 7.5 ENGINE COMPARTMENT HOOD.

### 7.8.7.1 Coolant Level and Concentration

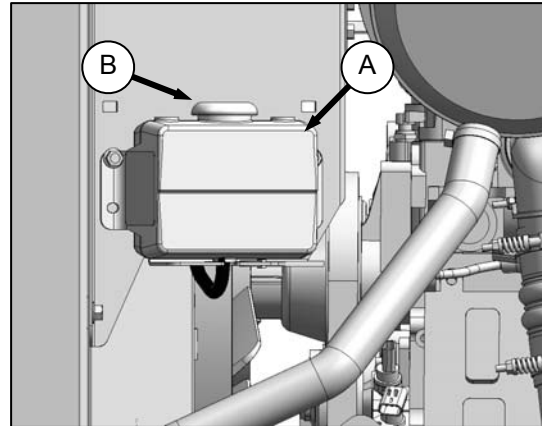

- Check daily the coolant level in the coolant recovery tank (A). Tank should be at least one-half full.
- If less, then remove cap (B), and add coolant. Use Ethylene Glycol with SCA equal parts with high quality, soft, de-ionized or distilled water as recommended by the supplier to protect the engine to temperatures of -30°F (-34°C).

#### NOTE

*Do not add coolant to radiator except when changing coolant.*

- Replace cap (B).

## MAINTENANCE AND SERVICING

### 7.8.7.2 Radiator Cap



#### WARNING

- To avoid personal injury from hot coolant, do **not** turn radiator cap until engine has cooled.
  - Engine exhaust may be hot.
- a. Move maintenance platform to aft position.
  - b. Remove the radiator cap, and check as follows:
    1. The radiator cap must fit tightly.

#### NOTE

Cap gasket must be in good condition to maintain the 14 - 18 psi (97 - 124 kPa) pressure in the cooling system.

To check the cap, proceed as follows:

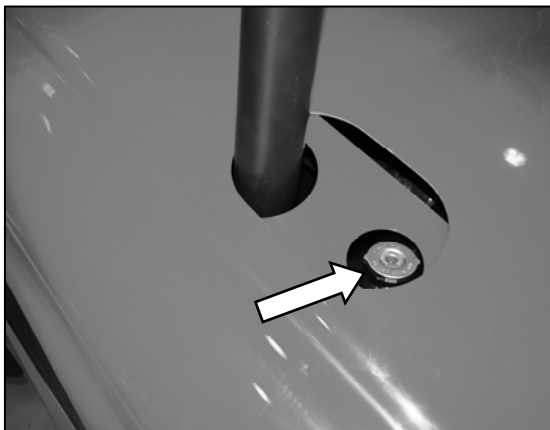

2. Turn the cap counter clockwise to the first notch to relieve pressure before removing cap completely.
  3. Turn the cap again, and remove.
  4. Check the gasket for cracks or deterioration, and replace the cap if necessary.
  5. Check that the spring in the cap moves freely.
  6. Check the anti-freeze in the radiator with a tester annually, preferably before off-season storage. Tester should indicate protection to temperatures of -30°F (-34°C).
- c. If spring is stuck, replace the cap.
  - d. Move maintenance platform to working position.
  - e. Close engine compartment hood.

### 7.8.7.3 Changing Coolant

Coolant should be drained, and the system flushed and filled with new coolant every 2000 hours, or 2 years.

Change coolant, and flush the system as follows:



#### CAUTION

To avoid personal injury from hot coolant, do **not** turn radiator cap until engine cools.



#### DANGER

Stop engine, and remove key from ignition before leaving Operator's seat for any reason. A child or even a pet could engage an idling machine.

- a. Stop engine, and let it cool.
- b. Raise engine compartment hood to lowest position. See Section 7.5 ENGINE COMPARTMENT HOOD.
- c. Move maintenance platform to aft position.

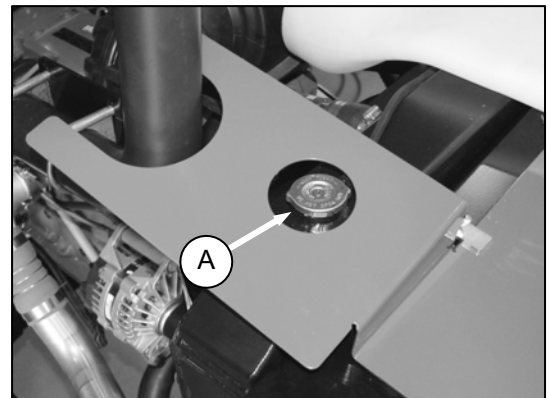

- d. Before removing cap completely, turn the radiator cap (A) to the first notch to relieve pressure.
- e. Place a drain pan (about 8 U.S. gallons (30 liters)) under the engine and radiator.

(continued next page)

## MAINTENANCE AND SERVICING

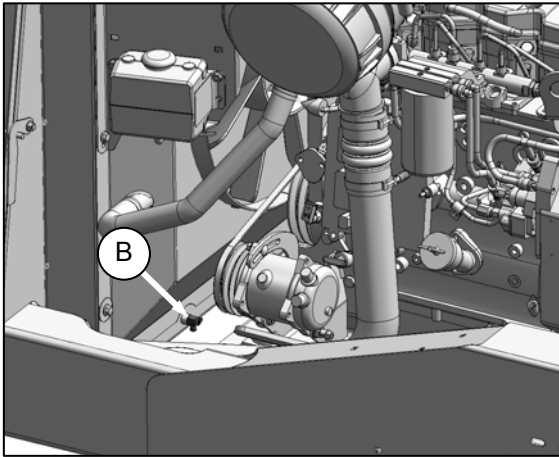

- f. Remove the radiator cap, and open radiator drain valve (B) on the engine side of the radiator lower tank. Use a deflector or a hose to prevent coolant running onto frame.

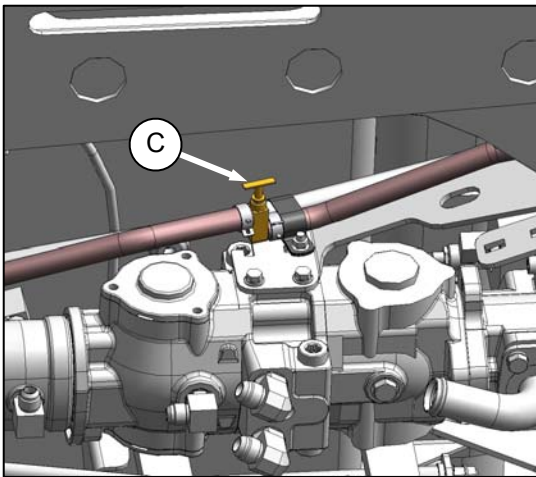

- g. Close the heater shut-off valve (C), and disconnect hose on heater side of valve.  
h. Open valve to drain the block.  
i. When system is drained, replace hose on valve (C), and close radiator drain valve (B).  
j. Fill system with clean water through the radiator, and replace radiator cap.  
k. Open heater shut-off valve (C).

- l. Start engine, and turn TEMPERATURE CONTROL knob to HIGH. Run engine until normal operating temperature is reached.  
m. Stop engine, and drain water out before rust or sediment settles. See steps d. to h.  
n. Close drain valves, and fill system with a solution of clean water and a heavy duty radiator cleaner. Follow instructions provided with cleaner.  
o. After using cleaner solution, again flush system with clean water. Inspect radiator, hoses and fittings for leaks.  
p. Close drain valves and fill system through radiator. Use Ethylene Glycol with SCA equal parts with high quality, soft, de-ionized or distilled water as recommended by the supplier. System capacity is 6.6 U.S. Gallons (25 liters).  
q. Close radiator cap tightly.

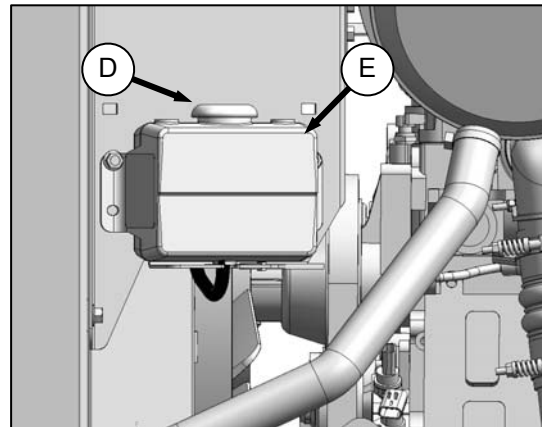

- r. Remove cap (D) from recovery tank (E), and add coolant until one-half full.  
s. Move maintenance platform to working position, and close engine compartment hood.

## MAINTENANCE AND SERVICING

### 7.8.8 Gearbox

#### 7.8.8.1 Lubricant Level



### CAUTION

Park on a flat, level surface, header on the ground and the ground speed lever in N-DETENT position.



### DANGER

Stop engine, and remove key from ignition before leaving Operator's seat for any reason. A child or even a pet could engage an idling machine.

- a. Check the lubricant level every 50 hours as follows:
  1. Park windrower on level ground, shut down engine, and remove key.

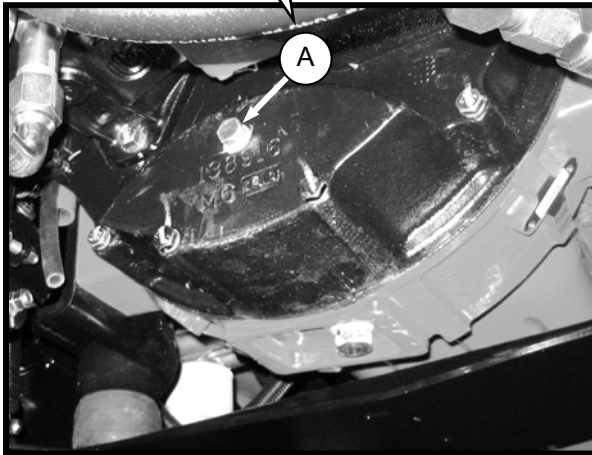
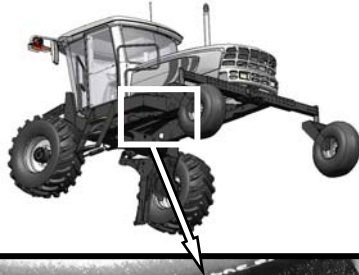

2. Remove plug (A). The lubricant should be visible through the hole, or slightly running out.

- b. Add lubricant as follows:

1. Raise engine compartment hood to highest position. See Section 7.5 ENGINE COMPARTMENT HOOD.

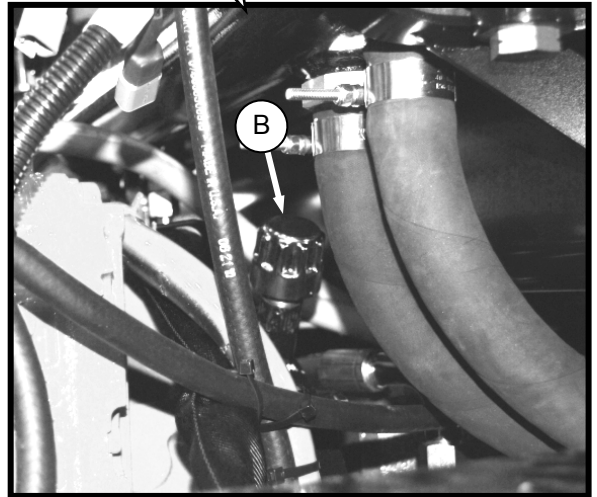
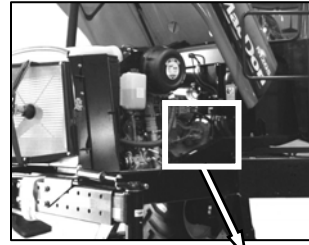

2. Remove breather cap (B), and add lubricant until it runs out at (A). Use SAE 75W-90 API Service Class GL-5, Fully Synthetic Transmission Lubricant. SAE J2360 is preferred.
3. Replace plug and breather cap, and tighten.

## MAINTENANCE AND SERVICING

### 7.8.8.2 Changing Lubricant

Change gearbox lubricant after the first 50 hours, and then at every 500 hours as follows:

#### NOTE

*The engine should be warm prior to changing the oil.*

- Stop engine, and remove key.
- Place a 1 U.S. gallon (4 liters) drain pan under the gearbox.

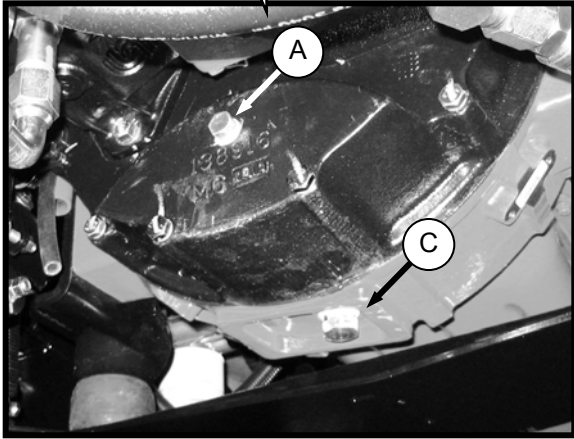
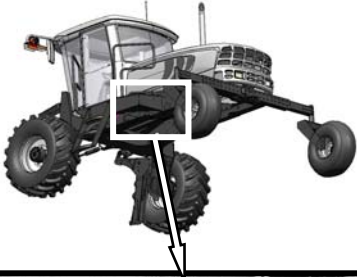

- Remove drain plug (C), and allow the oil to completely finish draining.
- Install the drain plug (C), and remove the check plug (A).

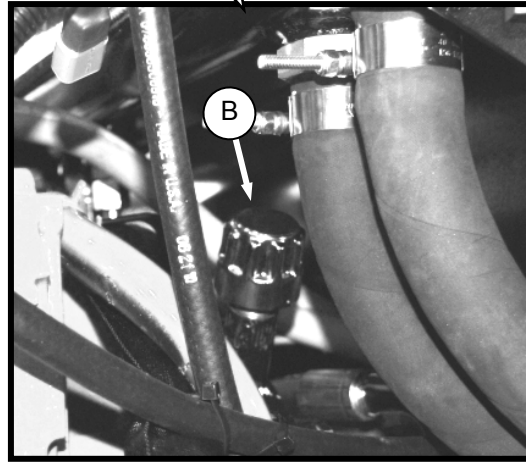
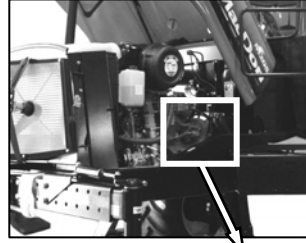

- Unscrew breather cap (B), and add lubricant.

The gearbox will require 2.2 U.S. quarts (2.1 liters). Add sufficient lubricant until it slightly runs out of hole (A). Use SAE 75W-90 API Service Class GL-5, Fully Synthetic Transmission Lubricant. SAE J2360 is preferred.

- Install plugs (A) and (C).
- Operate the engine at low idle, and check for leaks at the check plug, and at the drain plug.



## MAINTENANCE AND SERVICING

### 7.8.9 Exhaust System



#### CAUTION

To avoid burns, do not touch muffler when engine is running, or before allowing sufficient cooling time after shut-down

The exhaust system requires no regular maintenance, but it should be inspected periodically as follows:

- a. Open engine compartment hood to highest position. See Section 7.5 ENGINE COMPARTMENT HOOD.

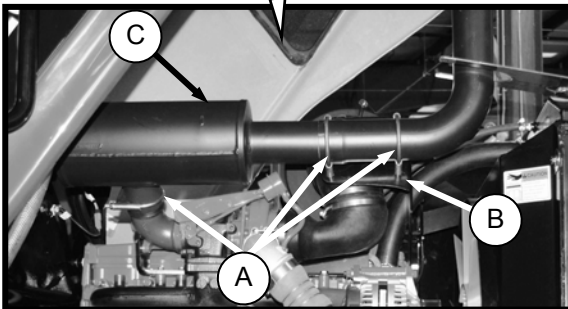
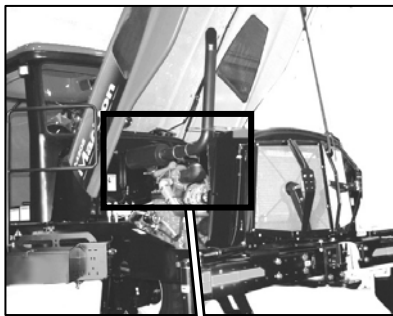

- b. Inspect the area around clamps (A) for breakage, cracks and rust-through. In addition to excess noise, a leaky exhaust system may allow exhaust gases to escape to the cab.
- c. Dents or crushed portions of any tubing create exhaust flow restriction, and increase back pressure significantly. Even relatively small dents will cause decreased fuel economy and increased turbo wear. If dents are relatively large, increased bearing and cylinder wear will occur due to increased exhaust temperature.
- d. The exhaust system should be secured to eliminate vibration. The brackets (B) should fit securely to the muffler (C), and to the engine.
- e. Do not change muffler type, piping sizes or exhaust configuration as these have all been selected for very specific, technical reasons by the Engineer. See your Dealer for proper replacement parts.

## MAINTENANCE AND SERVICING

### 7.8.10 Belts



#### DANGER

Stop engine, and remove key from ignition before leaving Operator's seat for any reason. A child or even a pet could engage an idling machine.

#### 7.8.10.1 Tension

- The alternator, water pump, and fan belt are automatically tightened, and manual adjustment is not required.
- Tension A/C compressor belt (A) as follows:

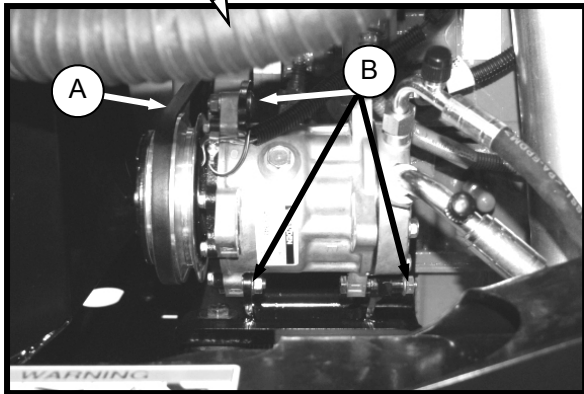

- Shut down engine, and open engine compartment access hood to lowest position. See Section 7.5 ENGINE COMPARTMENT HOOD.
- Loosen compressor mounting hardware (B).
- Pry compressor away from engine so that a force of 8 to 12 lbf (35 - 55 N) deflects the belt (A) 3/16 inch (5 mm) at mid-span.
- Tighten compressor mounting hardware.
- Re-check tension, and re-adjust as required.

#### 7.8.10.2 A/C Compressor Belt Replacement

- Shut down engine, and open engine compartment access hood to lowest position. Refer to illustration opposite.
- Loosen compressor mounting hardware (B), and push compressor towards engine to release tension.
- Remove belt (A).
- Install new belt (A) on pulleys.
- Pry compressor away from engine so that a force of 8 to 12 lbf (35 - 55 N) deflects belt (A) 3/16 inch (5 mm) at mid-span.
- Tighten compressor mounting hardware (B).
- Re-check tension, and re-adjust as required.

#### 7.8.10.3 Fan Belt Replacement



#### DANGER

Stop engine, and remove key from ignition before leaving Operator's seat for any reason. A child or even a pet could engage an idling machine.

- Shut down engine, and open engine compartment access hood to highest position.



- Move maintenance platform to the rear of windrower.

*(continued next page)*

## MAINTENANCE AND SERVICING

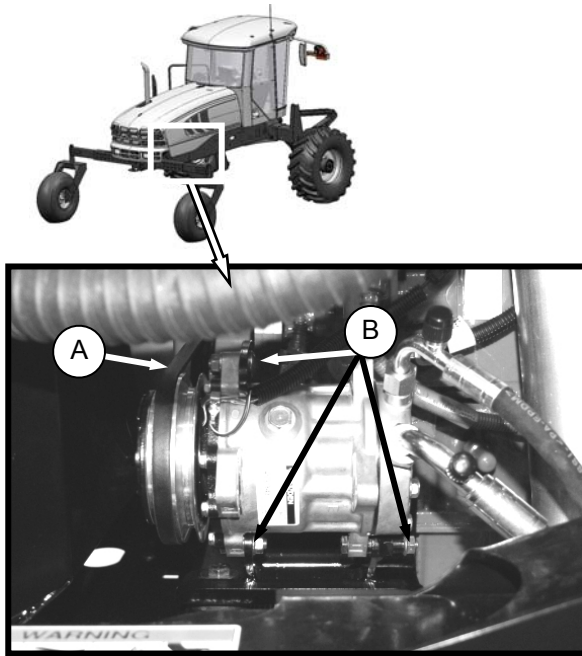

- c. Loosen compressor mounting hardware (B), and push compressor towards engine to release belt (A) tension.
- d. Remove belt (A).

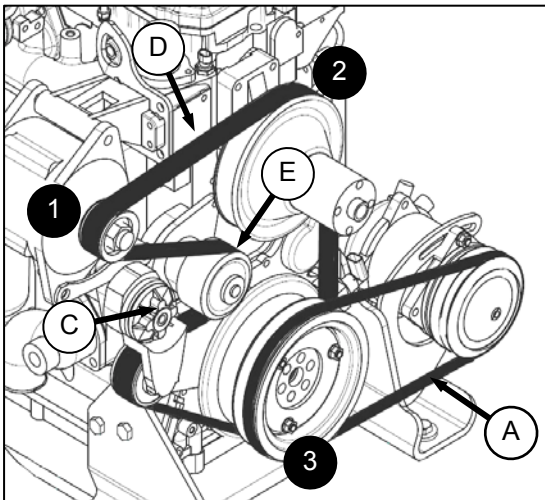

- e. Insert the drive end of a 1/2 inch drive ratchet wrench into the belt tensioner (C).
- f. Rotate tensioner counter clockwise until fan belt (D) can be slipped off pulley (E). Release tensioner, and remove wrench.

- g. Remove belt in order 1 - 2 - 3 as shown. Route fan belt around fan, and remove belt.
- h. Install new belt (D) around fan, and onto pulleys in order 3 - 2 - 1.
- i. Insert the drive end of a 1/2 inch drive ratchet wrench into the belt tensioner (C).
- j. Rotate tensioner counter clockwise until belt (D) can be slipped onto pulley (E). Release tensioner, and remove wrench.
- k. Check that belt is properly seated in all pulley grooves.
- l. Install A/C compressor belt (A) on pulleys.
- m. Pry compressor away from engine so that a force of 8 to 12 lbf (35 - 55 N) deflects the belt (A) 3/16 inch (5 mm) at mid-span.
- n. Tighten compressor mounting hardware (B).
- o. Re-check tension, and re-adjust as required.
- p. Move maintenance platform to working position, and close engine compartment hood.

### 7.8.11 Engine Speed

The maximum and idle engine speeds are factory-set to the specifications. See Section 4.2 SPECIFICATIONS. If specified speeds cannot be maintained, see your Dealer.

#### IMPORTANT

Do not remove any seals from injector pump; removal of seals will **void the engine warranty**.

See also Section 6.3.4.2 Engine Intermediate Speed Control (ISC).

#### 7.8.11.1 Throttle Adjustment

The engine speed is controlled with the throttle lever that is connected to an electronic sensor inside the console.

The throttle lever in the cab should move the throttle sensor the full range between the slow speed stop and the full RPM stop without contacting the console at either position.

If the throttle lever is contacting the console and interferes with specified engine speeds, the sensor position possibly requires adjustment. See your Windrower Dealer.

## MAINTENANCE AND SERVICING

### 7.9 COOLING BOX

#### 7.9.1 Cooling Box Screen

The cooling box screen is equipped with an automatic cleaning device that vacuums the screen by means of two rotors. They only operate when the engine is running. The rotors are electrically driven, and the suction is provided by the engine cooling fan.

If the screen is not being cleaned by the rotors, they may be plugged.

Service rotors and screen as follows:

- Stop engine, and remove key.
- Raise engine compartment hood fully. See Section 7.5 ENGINE COMPARTMENT HOOD.
- If rotors (A) are plugged, clean as follows:

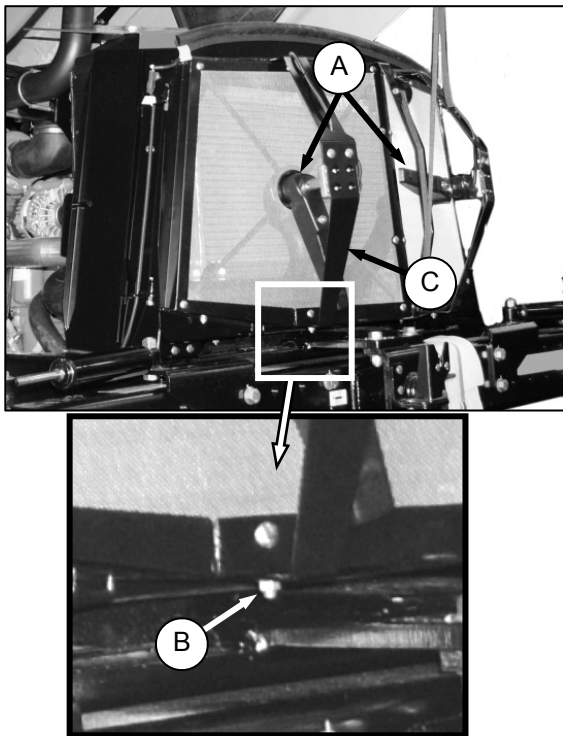

1. Remove nut (B).

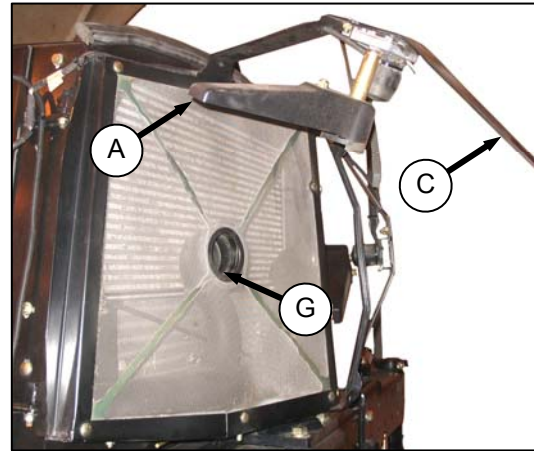

2. Pivot rotor assembly (C) away from screen.
3. Blow out debris from rotors (A) with compressed air.

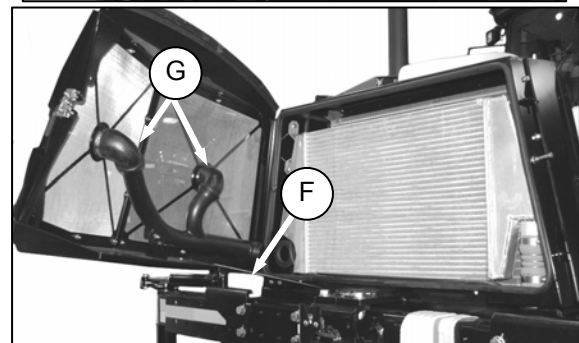
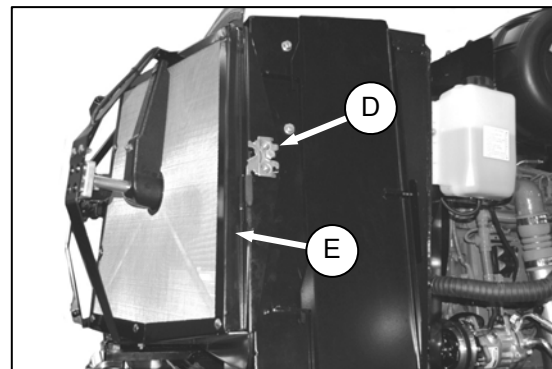

- d. Push latch (D), and open screen access door (E). Secure with rod (F) stored inside screen door.
- e. If ducts (G) are plugged, blow out debris with compressed air.
- f. Clean screen with compressed air.
- g. Re-position rotor assembly (C), and secure with bolt and nut (B).
- h. Close screen access door (E), and engage latch (D).

## MAINTENANCE AND SERVICING

### 7.9.2 Rotor To Screen Clearance

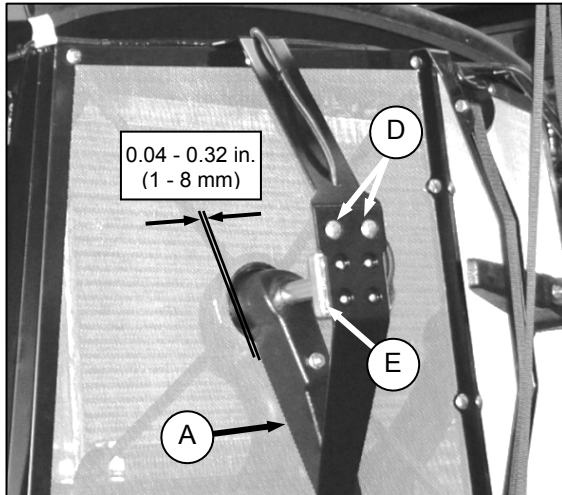

- a. Check clearance between trailing edge of rotor (A) and the screen. It should be .04 - .32 inches (1 - 8 mm) at all locations when rotating.

#### NOTE

*Rotor may touch screen as long as it continues to rotate.*

- b. If necessary, adjust clearance as follows:

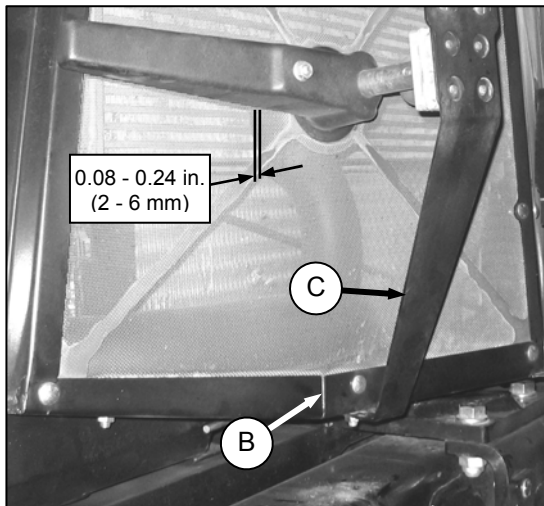

1. Loosen nut (B) on motor support (C).
2. Move support in or out until duct is 0.08 - 0.24 in. (2 - 6 mm) from screen near the center.
3. Re-tighten nut (B).
4. Loosen the two motor mount bolts (D).
5. Move motor / duct assembly (E) to obtain 0.04 - 0.32 in. (1 - 8 mm) gap to screen at full rotation of the duct.
6. Re-tighten nuts (D) on motor mount.

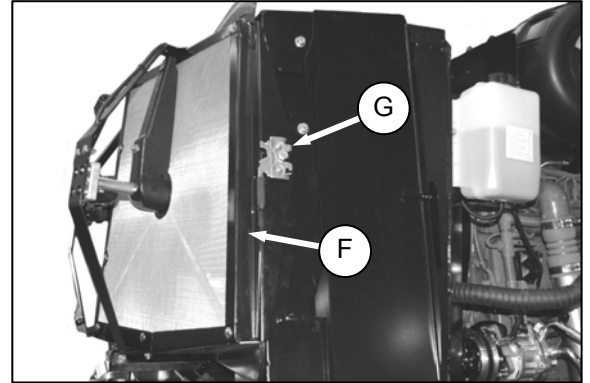

- c. Close screen access door (F), and engage latch (G).
- d. Lower engine compartment hood.

## MAINTENANCE AND SERVICING

### 7.9.3 Cooling Box Maintenance

The radiator and oil cooler should be cleaned daily with compressed air. More frequent cleaning may be necessary in severe conditions.

The charge air cooler and air conditioning condenser may also be cleaned at the same time.

To clean these components, proceed as follows:



### DANGER

**Stop engine, and remove key from ignition before leaving Operator's seat for any reason. A child or even a pet could engage an idling machine.**

- Stop engine, and remove key.
- Raise engine compartment hood fully. See Section 7.5 ENGINE COMPARTMENT HOOD.

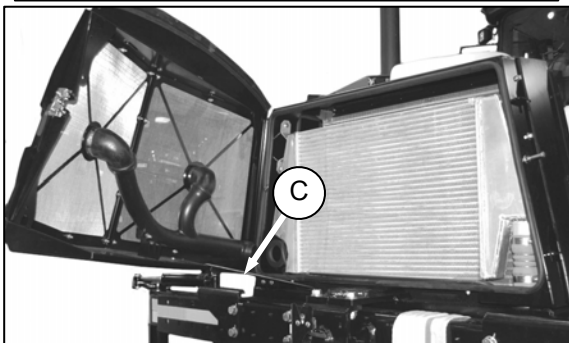
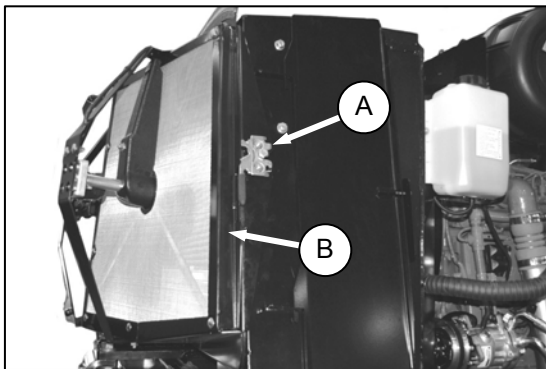

- Push latch (A), and open screen assembly access door (B). Secure with rod (C) stored inside the screen door.

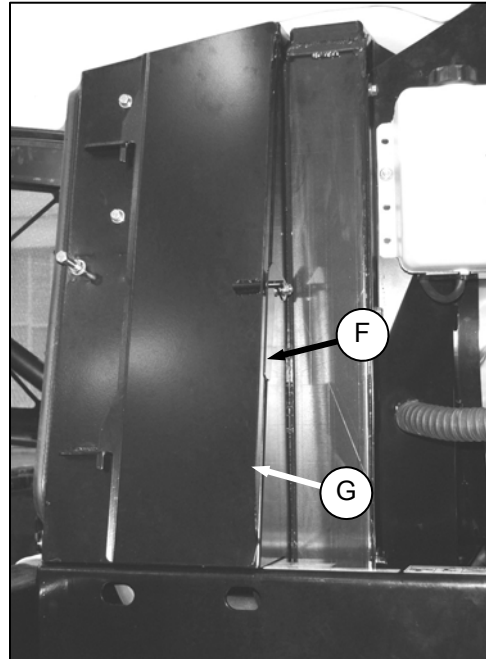

- Lift lever (F), and pull open access door (G).

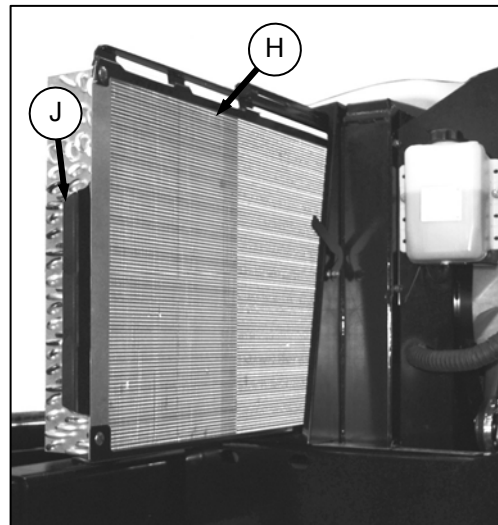

- Slide out the oil cooler/A/C condenser assembly (H) with handle (J).

*(continued next page)*

## MAINTENANCE AND SERVICING

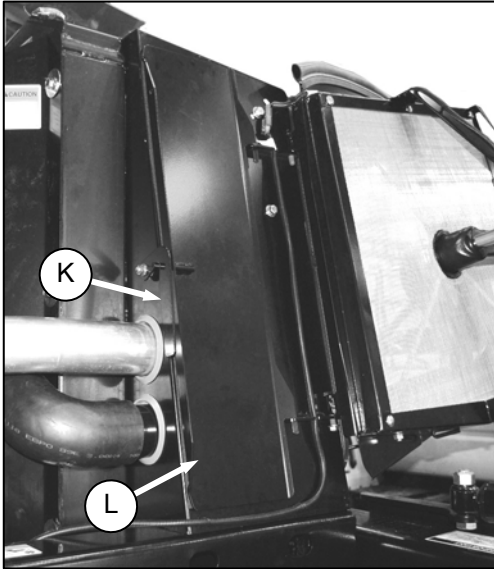

- f. Lift latch (K), and open access door (L) at left side of cooling box.

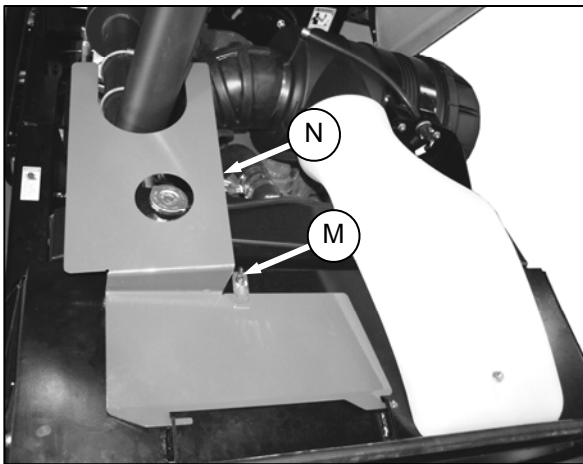

- g. Remove wing-nut (M), and open access door (N) at top of cooling box.

### IMPORTANT

Fins on coolers can be very easily bent which may interfere with its function. Exercise caution when cleaning.

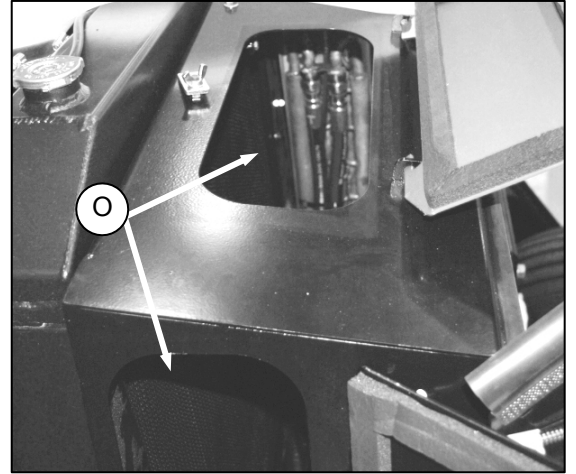

- h. Clean radiator (O) through access holes in cooling box with compressed air.



- i. Clean oil cooler/A/C condenser (P), charge air cooler (Q), and cooling box (S) with compressed air.
- j. Inspect all lines and coolers for evidence of leaks and damage.

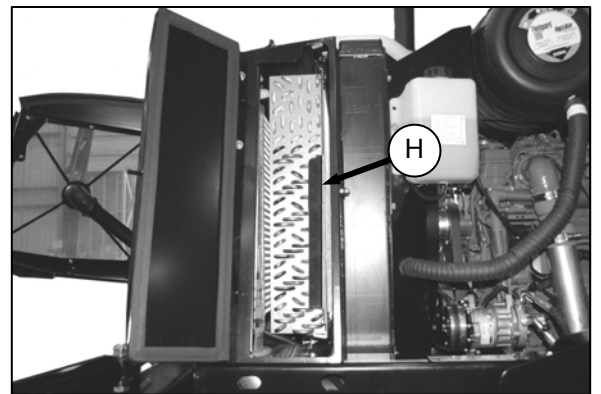

- k. Slide oil cooler/ AC condenser (H) back into cooling box.

*(continued next page)*

## MAINTENANCE AND SERVICING

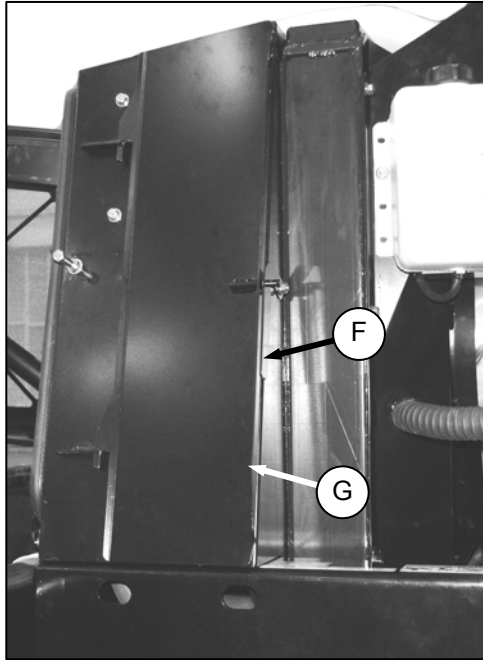

- l. Close side access door (G), and lock with lever (F).

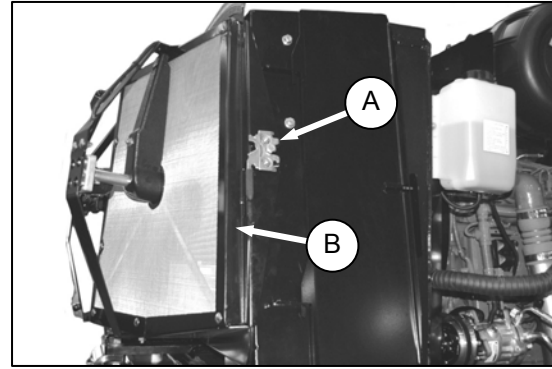

- o. Close screen door (B) until latch engages pin (A).
- p. Close engine compartment hood.

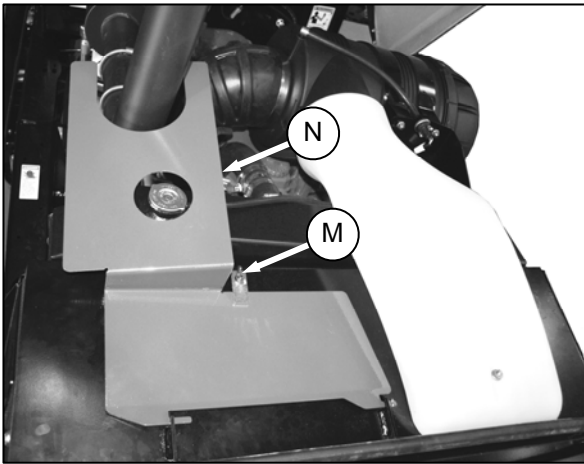

- m. Close top door (N), and secure with wing-nut (M).

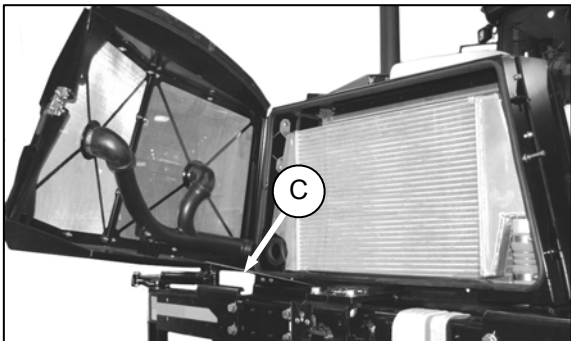

- n. Unhook support rod (C) in screen door, and store in screen door.



## MAINTENANCE AND SERVICING

### 7.10 ELECTRICAL SYSTEM

#### 7.10.1 Batteries

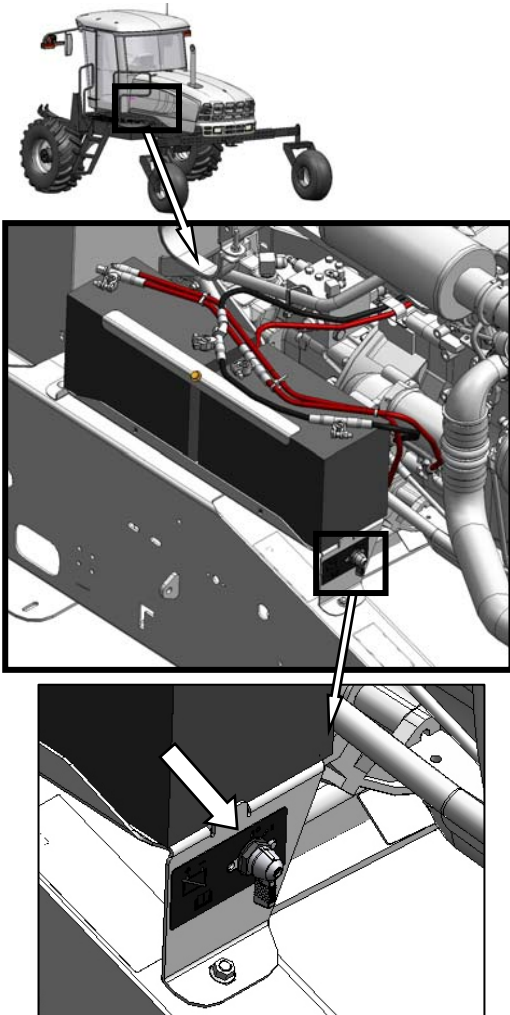

The M105 is equipped with two batteries that are located under the engine compartment hood at the left side of the engine compartment.

A battery main disconnect switch is located on the battery tray.

Ensure disconnect switch is switched to POWER OFF when performing major servicing to electrical components or for periods of non-use to prevent inadvertent loss of battery charge.



### WARNING

- Gas given off by battery electrolyte is explosive. Keep all smoking materials, sparks and flames away from batteries.
- Follow proper charging and boosting procedures given in this section.
- Ventilate when charging in enclosed space.



- Always wear protective eye-wear when working near batteries.
- Do **not** tip batteries more than 45° to avoid electrolyte loss.
- Battery electrolyte causes severe burns. Avoid contact with skin, eyes or clothing.
- Keep batteries out of reach of children.
- If electrolyte is spilled or splashed on clothing or the body, neutralize it immediately with a solution of baking soda and water, then rinse with clean water.
- Electrolyte splashed into the eyes is extremely dangerous. Should this occur, force the eye open, and flood with cool, clean water for five minutes. Call a Doctor immediately.
- To avoid shocks, burns or damage to electrical system, disconnect battery ground cable before working in an area where you might accidentally contact electrical components.
- Do **not** operate the engine with alternator or battery disconnected. With battery cables disconnected and engine running, a high voltage can be built up if terminals touch the frame. Anyone touching the frame under these conditions would be severely shocked.
- When working around storage batteries, remember that all of the exposed metal parts are live. Never lay a metal object across the terminals because a spark or short circuit will result.

## MAINTENANCE AND SERVICING

### 7.10.1.1 Maintenance



#### CAUTION

Do not attempt to service battery unless you have the proper equipment and experience to perform the job. Have it done by a qualified Dealer.

- a. Check battery charge once a year, and more often if operating in cold weather. Hydrometer readings should be 1.260 - 1.300. Readings below 1.250 indicate charging is required. See Section 7.10.1.2 Charging. Add electrolyte if necessary. See Section 7.10.1.4 Adding Electrolyte.
- b. Keep batteries clean by wiping with a damp cloth.
- c. Keep all connections clean and tight. Remove any corrosion, and wash terminals with a solution of baking soda and water. A light coating of grease on terminals (after cables are attached) will reduce corrosion.
- d. To prolong battery life, store batteries fully charged, and at +20° to +80°F (-7° to +26°C). Check voltage after storage, and recharge as needed, according to battery and charger manufacturer recommendations.
- e. Do not stack storage batteries on top of each other.

## MAINTENANCE AND SERVICING

### 7.10.1.2 Charging



#### CAUTION

- Ventilate the area where batteries are being charged.
- Do not charge a frozen battery. Warm to 60°F (16°C) before charging.
- Do not connect or disconnect live circuits. To prevent sparks, turn off charger, and connect positive cable first.
- If charging battery in windrower, disconnect positive battery cable before connecting charger cable, then connect ground cable last, away from battery.
- Stop or cut back charging rate if battery feels hot, or is venting electrolyte. Battery temperature must not exceed 125°F (52°C).

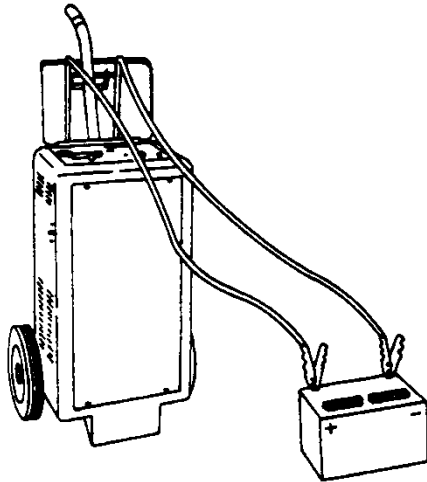

- Follow all instructions and precautions furnished by the battery charger manufacturer. Charge at recommended rates and times.

### 7.10.1.3 Boosting

A twelve volt battery can be connected in parallel (+ to +) with the windrower battery. Use heavy-duty battery cables.



#### CAUTION

- Gas given off by batteries is explosive. Keep sparks and flames away from batteries.
  - Make last connection and first disconnection at a point furthest away from the batteries.
  - Wear protective eye-wear when using a booster battery.
  - Be sure everyone is clear of machine when starting engine. Start engine from Operator's station only.
- a. Open engine compartment hood to lowest position.

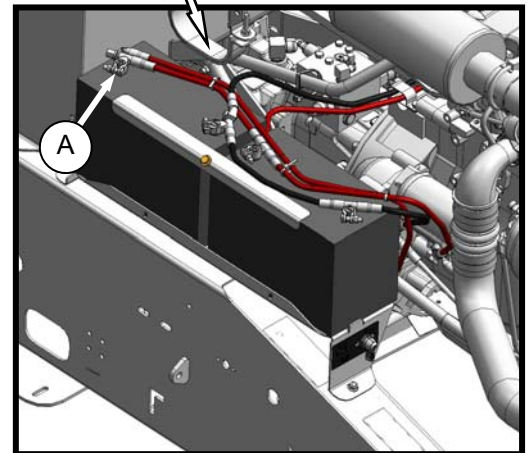

- b. Remove red rubber cover (A) from windrower battery positive terminal.

*(continued next page)*

## MAINTENANCE AND SERVICING

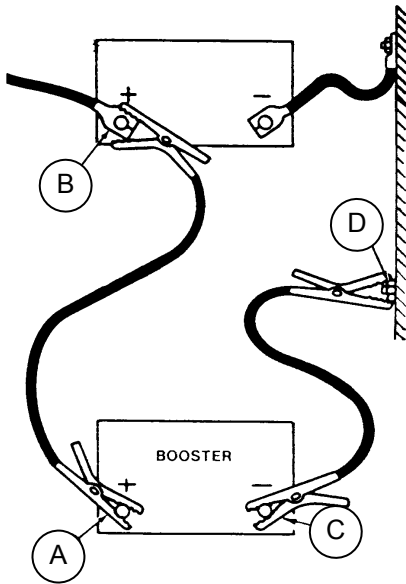

- c. Attach one end of battery cable to positive terminal (A) of booster battery, and other end to positive terminal (B) of windrower batteries.
- d. Attach second cable to negative terminal (C) of booster battery, and then to a good ground (D) on windrower frame.
- e. Turn IGNITION switch in cab as with normal startup.
- f. After engine starts, disconnect cable from windrower ground first, and then disconnect the other cables.
- g. Close engine compartment hood.

### 7.10.1.4 Adding Electrolyte



#### WARNING

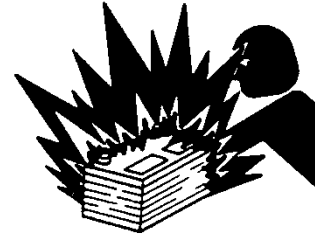

- Keep all smoking materials, sparks and flames away from electrolyte container and battery, as gas given off by electrolyte is explosive.



- Battery electrolyte causes severe burns. Avoid contact with skin, eyes or clothing. Wear protective eyewear and heavy gloves.



#### WARNING

- If electrolyte is spilled or splashed on clothing or on the body, neutralize it immediately with a solution of baking soda and water, then rinse with clean water.
  - Electrolyte splashed into the eyes is extremely dangerous. Should this occur, force the eye open, and flood with cool, clean water for five minutes. Call a Doctor immediately.
- a. If battery is installed in windrower, shut down engine, and remove key.
  - b. Add electrolyte in accordance with the battery manufacturer's instructions.

## MAINTENANCE AND SERVICING

### 7.10.1.5 Replacing Battery



#### CAUTION

Do not attempt to service battery unless you have the proper equipment and experience to perform the job. Have it done by a qualified Dealer.



#### DANGER

Stop engine, and remove key from ignition before leaving Operator's seat for any reason. A child or even a pet could engage an idling machine.

The batteries should conform to the following specification:

RATING	BCI GROUP	CCA	VOLT
Heavy Duty, Off-Road, Vibration Resistant	31A or 29H	650 (min)	12

- Stop engine, and remove key.
- Open engine compartment hood to highest position. See Section 7.5 ENGINE COMPARTMENT HOOD.

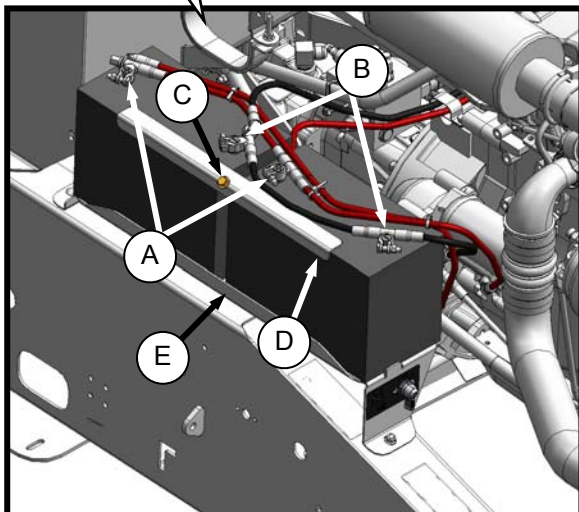

- Remove red plastic cover from positive cable clamps (A). Loosen clamps, and remove cable from batteries.
- Loosen clamps (B) on negative terminals, and remove cable from batteries.
- Remove bolts (C) securing strap (D) to frame, and remove strap.
- Lift batteries off holder (E).
- Place new batteries on holder (E).
- Install strap (D) with bolts (C).

#### IMPORTANT

BATTERY IS NEGATIVE GROUNDED. Always connect starter cable to the positive (+) terminal of battery, and battery ground cable to negative (-) terminal of battery. Reversed polarity in battery or alternator may result in permanent damage to electrical system.

- Attach negative (black) cable clamps (B) to negative post on batteries, and tighten clamps.
- Attach positive (red) cable clamps (A) to positive post on batteries, and tighten. Place plastic covers onto clamps.
- Close engine compartment hood.

## MAINTENANCE AND SERVICING

### 7.10.1.6 Preventing Electrical System Damage

- a. Carefully observe polarity when attaching booster battery.
- b. Do not short across battery or alternator terminals, or allow battery positive (+) cable or alternator wire to become grounded.
- c. Be sure alternator connections are correct before cables are connected to battery. Refer to illustration below.
- d. When welding on any part of the machine, disconnect battery cables and alternator wire. See also Section 7.1.1 *Welding Precautions*.
- e. Always disconnect battery ground cable when working with the alternator or regulator.
- f. Never attempt to polarize alternator or regulator.
- g. If wires are disconnected from the alternator, use the illustration below to ensure proper reconnection.

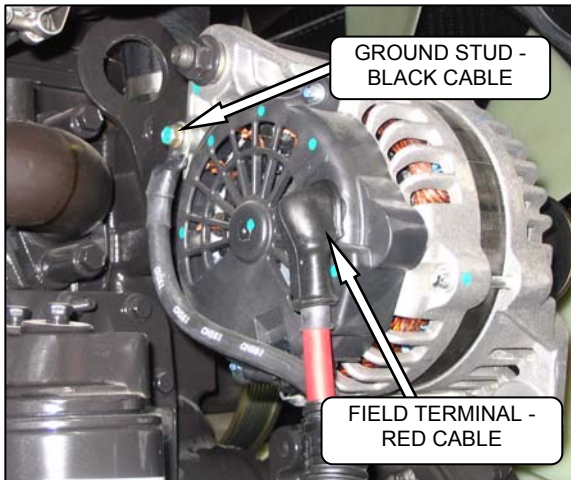

- h. Never ground the alternator field terminal or field circuit.
- i. Never connect or disconnect alternator or regulator wires with battery connected or alternator operating.
- j. Always disconnect cables from the battery when using a charger to charge battery in windrower.
- k. Ensure all cables are securely connected before operating engine.

## MAINTENANCE AND SERVICING

### 7.10.2 Headlights



#### DANGER

Stop engine, and remove key from ignition before leaving Operator's seat for any reason. A child or even a pet could engage an idling machine.

#### NOTE

Header should be attached and raised to maintain proper windrower stance.

#### 7.10.2.1 Adjustment

Adjust for maximum illumination while ensuring oncoming traffic cannot be blinded by the lights. The recommended setting is:

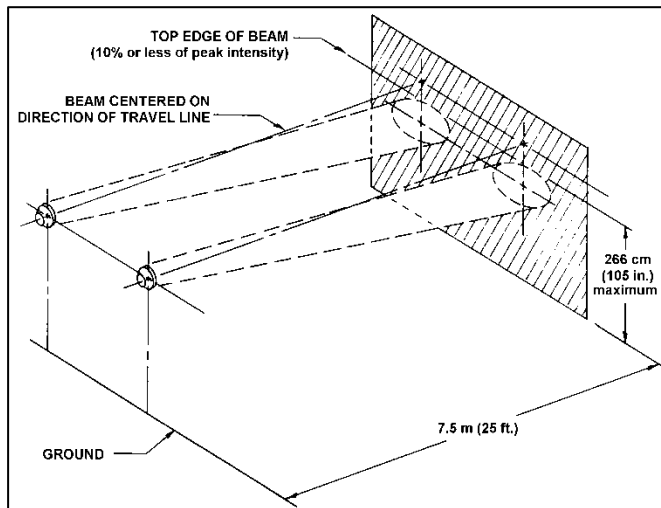

- Light beams laterally centered on the direction of travel line from the headlights (i.e. not skewed left or right).
- Upper limit of the beam not higher than 105 inches (266 cm) above ground at a distance of 25 FT (7.5 m) from the headlight.

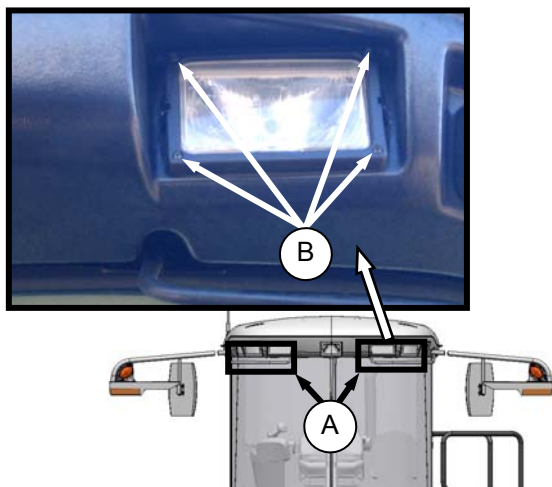

- Hold onto hand-holds (A) on the cab front corners, and stand on header anti-slip strips.
- Adjust lights with screws (B).

#### 7.10.2.2 Bulb Replacement

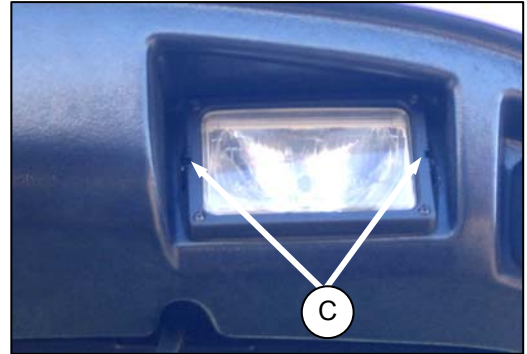

- Remove two screws (C), and remove light assembly.

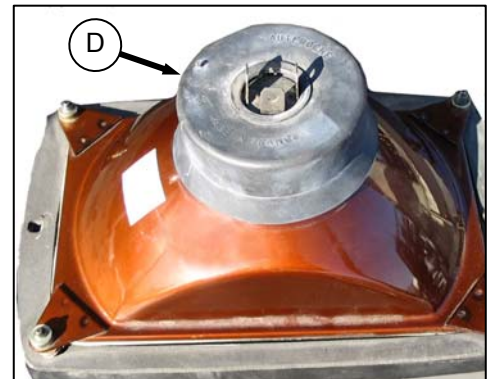

- Pull wiring harness connector off the headlight assembly, and remove rubber insulator boot (D).

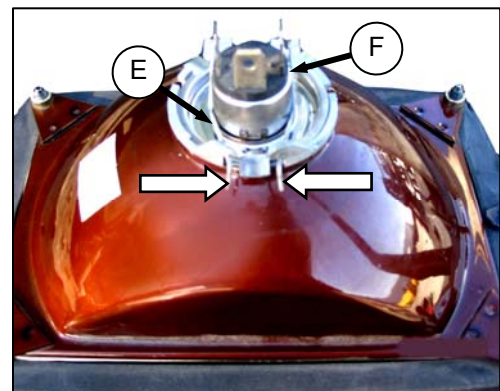

- Pinch wire retainer (E), and lift away from hooks.
- Remove bulb (F) from body.

#### IMPORTANT

Do not touch the glass of the halogen bulb as the oils or other chemicals from your skin will cause the bulb to fail prematurely.

(continued next page)

## MAINTENANCE AND SERVICING

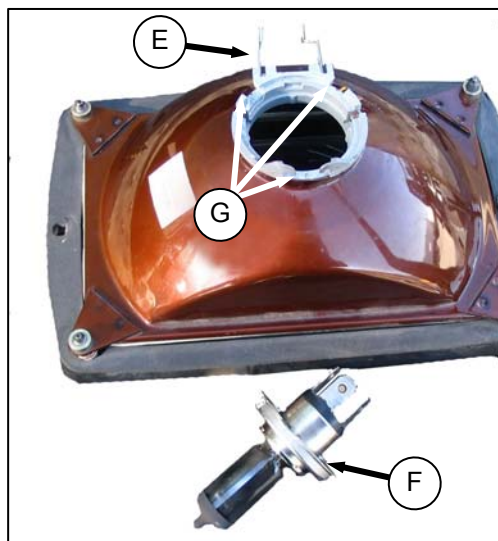

- e. Align lugs on new bulb (F) with slots (G) in body, and push into place.
- f. Secure bulb with wire retainer (E)

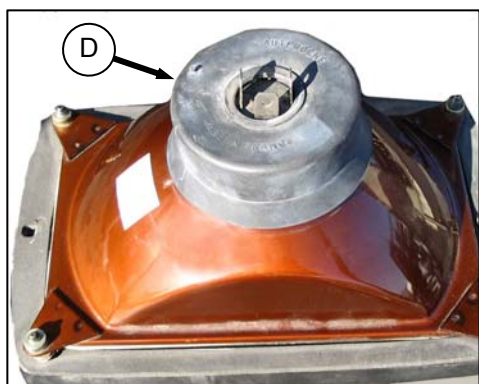

- g. Replace rubber insulator boot (D).
- h. Push connector onto bulb (F).

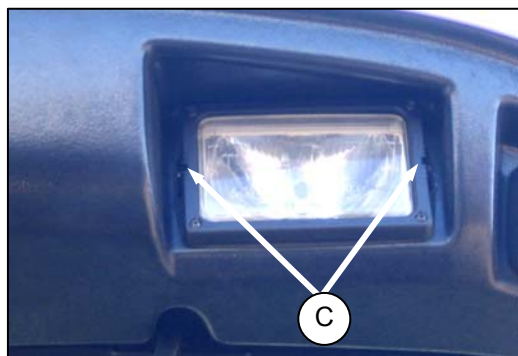

- i. Position headlight into light receptacle, ensuring top is up, and secure with screws (C).

### NOTE

*Aligning of light should not be necessary.*

### 7.10.3 Field Lights: Forward



## DANGER

Stop engine, and remove key from ignition before leaving Operator's seat for any reason. A child or even a pet could engage an idling machine.

#### 7.10.3.1 Adjustment

Field lights are best adjusted with the machine in the field (or equivalent) to suit Operator preference.

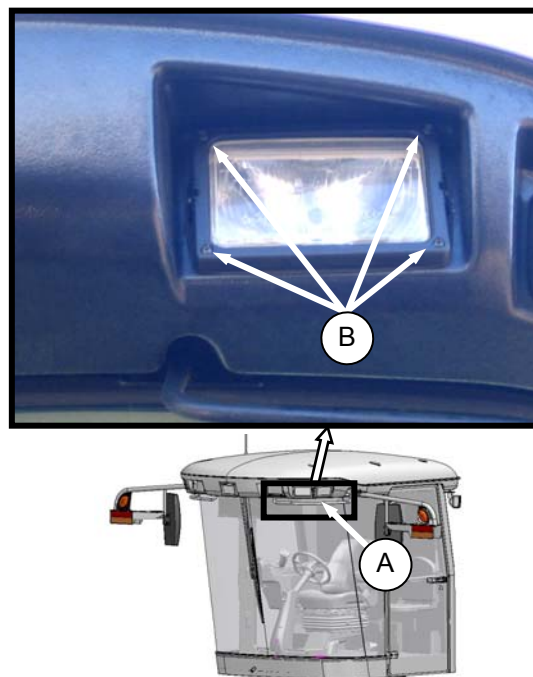

- a. Hold onto hand-holds (A) on cab front corners, and stand on header anti-slip strips.
- b. Adjust lights with screws (B).

#### 7.10.3.2 Bulb Replacement

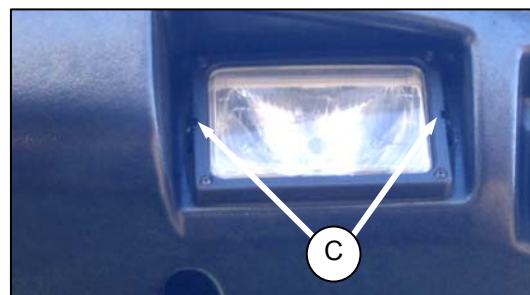

- a. Remove two screws (C), and remove light assembly.
- b. Replace bulb as described in Section 7.10.2.2 Bulb Replacement.



## MAINTENANCE AND SERVICING

### 7.10.4 Flood Lights: Forward

The forward floodlights are not adjustable.

Replace bulbs as follows:

- Shut down engine, and remove key. Turn lights OFF.

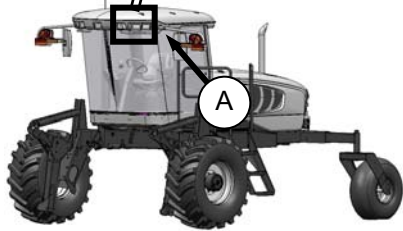
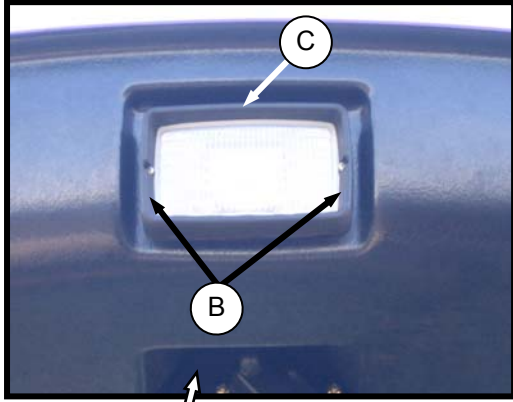

- Hold onto hand-holds (A) on cab front corners, and stand on header anti-slip strips when removing the forward field lights.
- Remove two screws (B), and remove light bezel (C).
- Remove light from receptacle.

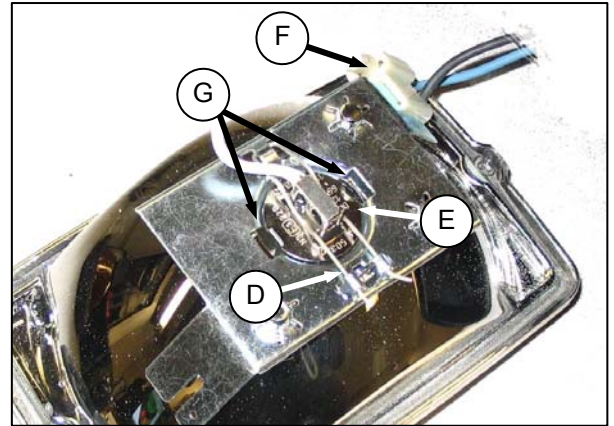

- Match slots on new bulb (E) with lugs (G) in optical unit, and insert bulb into unit.
- Secure bulb with wire retainer (D).
- Push wire into connector (F).

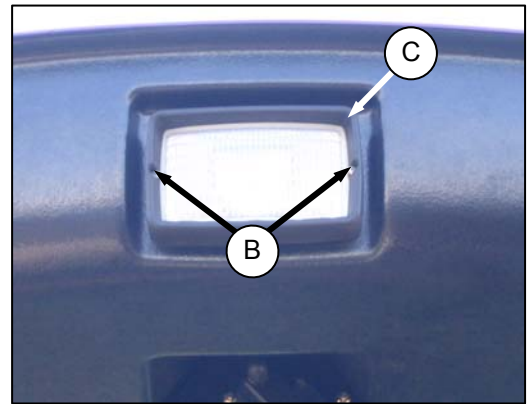

- Position light into light receptacle, ensuring top is up, and secure with bezel (C) and screws (B).

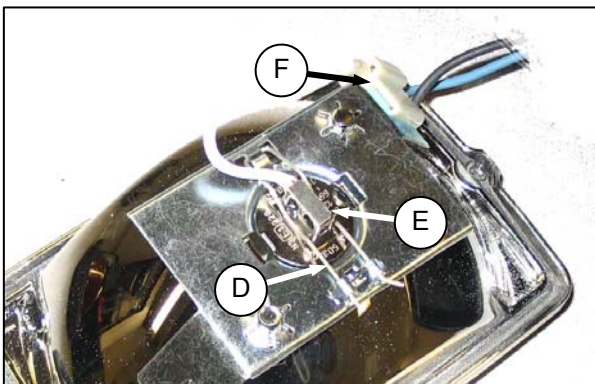

- Pinch wire retainer (D), and lift away from hooks.
- Remove bulb (E) from body, and pull wire from connector (F).

#### IMPORTANT

Do not touch the glass of the halogen bulb as the oils or other chemicals from your skin will cause the bulb to fail prematurely.

## MAINTENANCE AND SERVICING

### 7.10.5 Flood Lights: Rear



#### DANGER

Stop engine, and remove key from ignition before leaving Operator's seat for any reason. A child or even a pet could engage an idling machine.

#### 7.10.5.1 Adjustment

The rear floodlights are best adjusted with the machine in the field (or the equivalent) to suit Operator preference.

- Shut down engine, and remove key. Turn lights ON.

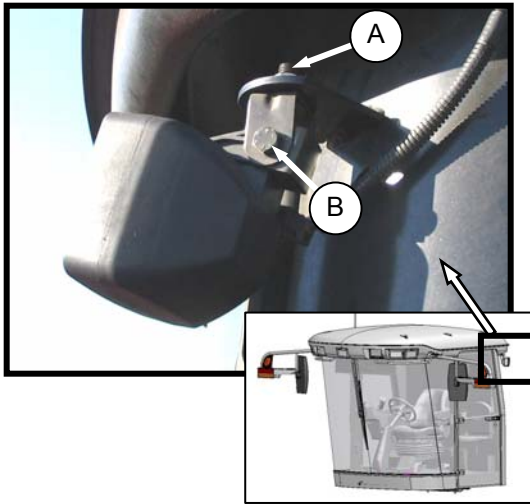

- Loosen bolts (A) and (B).
- Adjust light to desired position.
- Tighten bolts (A) and (B).

#### 7.10.5.2 Bulb Replacement

- Shut down engine, and remove key. Turn lights OFF.

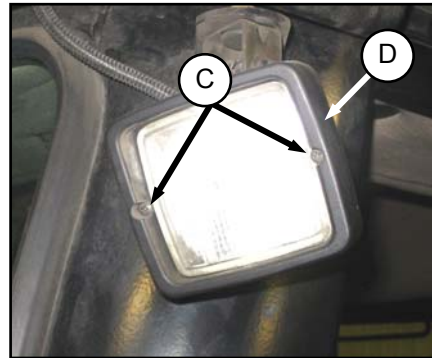

- Remove two screws (C), and remove light bezel (D).
- Remove light from receptacle.

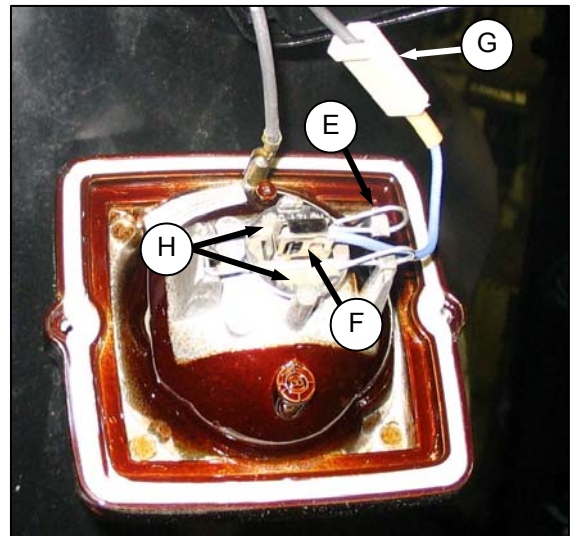

- Pinch the wire retainer (E), and lift away from hooks.
- Remove bulb (F) from body, and pull wire from connector (G).

#### IMPORTANT

Do not touch the glass of the halogen bulb as the oils or other chemicals from your skin will cause the bulb to fail prematurely.

- Match slots on new bulb (F) with lugs (H) in optical unit, and insert bulb into unit.
- Secure bulb with wire retainer (E).
- Push wire into connector (G).
- Position light into light receptacle, ensuring top is up, and secure with bezel (D) and screws (C).

## MAINTENANCE AND SERVICING

### 7.10.6 Swath Lights



#### DANGER

Stop engine, and remove key from ignition before leaving Operator's seat for any reason. A child or even a pet could engage an idling machine.

The swath lights are not adjustable.

Replace bulbs as follows:

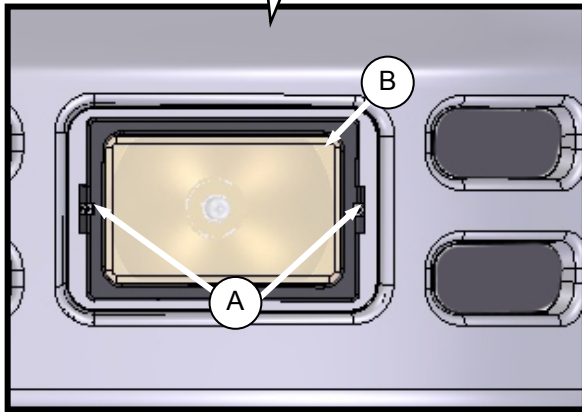
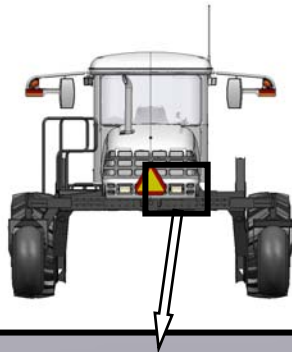

- Remove the two screws (A), and remove light bezel (B).
- Remove light from receptacle.

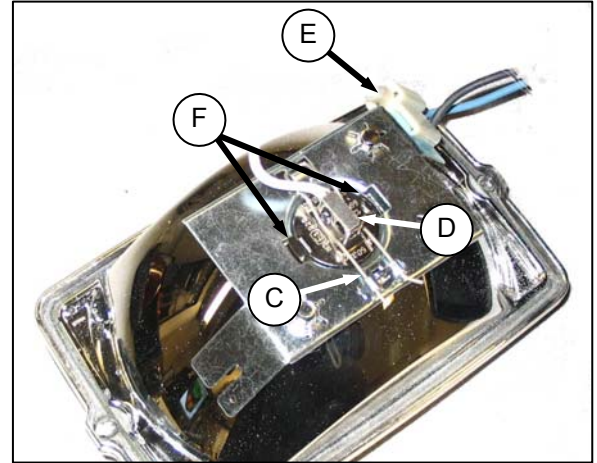

- Pinch the wire retainer (C), and lift away from hooks.
- Remove bulb (D) from body, and pull wire from connector (E).

#### IMPORTANT

Do not touch the glass of the halogen bulb as the oils or other chemicals from your skin will cause the bulb to fail prematurely.

- Match slots on new bulb (D) with lugs (F) in optical unit, and insert bulb into unit.
- Secure bulb with wire retainer (C).
- Push wire into connector (E).

#### IMPORTANT

For proper lighting pattern, be sure lights are installed right side up.

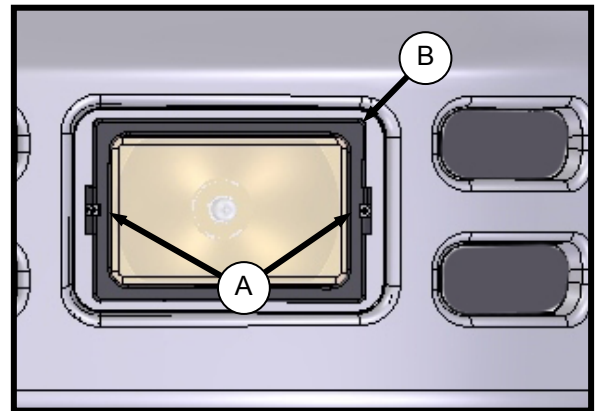

- Position light into light receptacle, ensuring top is up, and secure with bezel (B) and screws (A).

## MAINTENANCE AND SERVICING

### 7.10.7 Amber Lights

- a. Shut down engine, and remove key. Turn lights OFF.

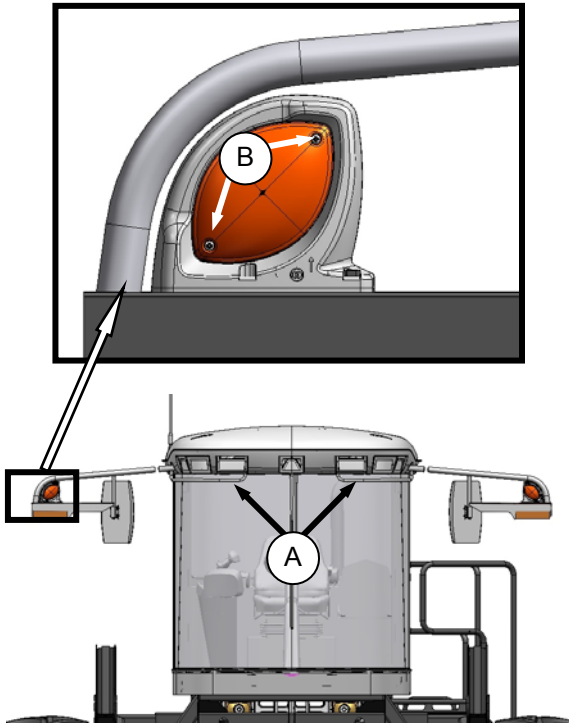

#### NOTE

Hold onto hand-holds (A) on cab front corners and stand on header anti-slip strips, or stand on maintenance platform when accessing the amber lights.

- b. Remove two screws (B) from lens, and remove lens.
- c. Push and twist light bulb to remove from socket.
- d. Install new bulb, ensuring that bulb base is properly engaged in socket. Use Bulb Trade #1156.
- e. Re-install lens with screws (B).

### 7.10.8 Beacons (If Installed)

- a. Shut down engine, and remove key. Turn beacons OFF.

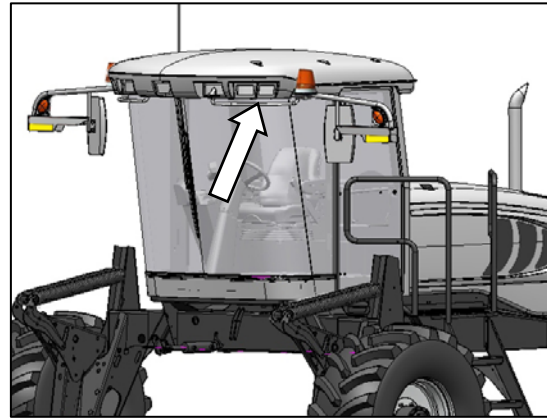

#### NOTE

Hold onto hand-holds on cab front corners, and stand on header anti-slip strips, or stand on maintenance platform when accessing the beacons.



- b. Turn lens counter clockwise to unlock lens from base, and remove lens.

*(continued next page)*

## MAINTENANCE AND SERVICING

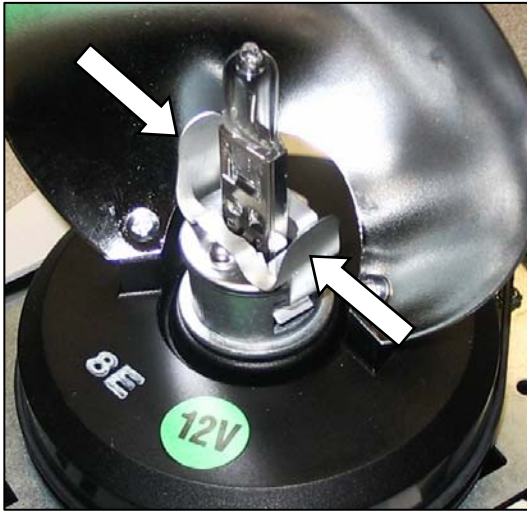

- c. Pinch retainer, and remove it from lamp socket.
- d. Pull lamp out of socket.

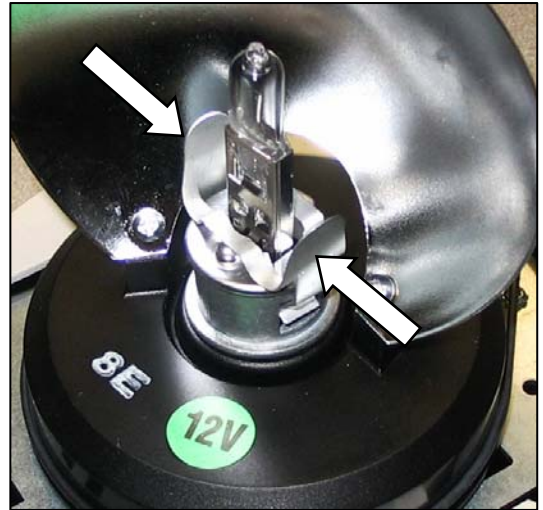

- g. Place retainer over lamp, and pinch tabs to secure retainer to socket.

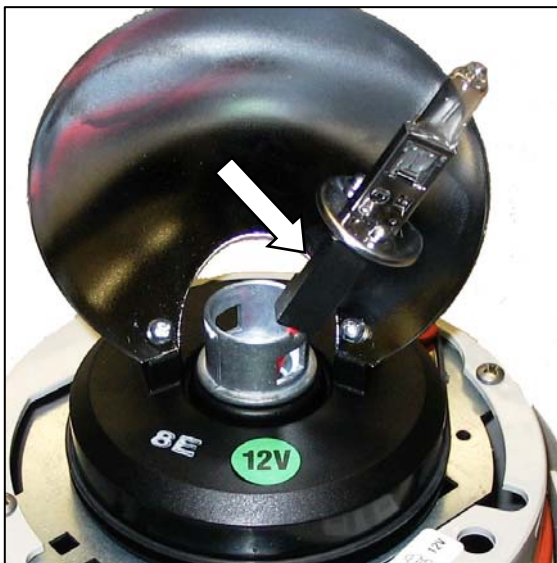

- e. Disconnect harness from lamp.

### IMPORTANT

Do not touch the glass of the halogen bulb as the oils or other chemicals from your skin will cause the bulb to fail prematurely.

- f. Connect harness to new lamp, place lamp in socket, and line-up flat side on lamp with recess in socket.

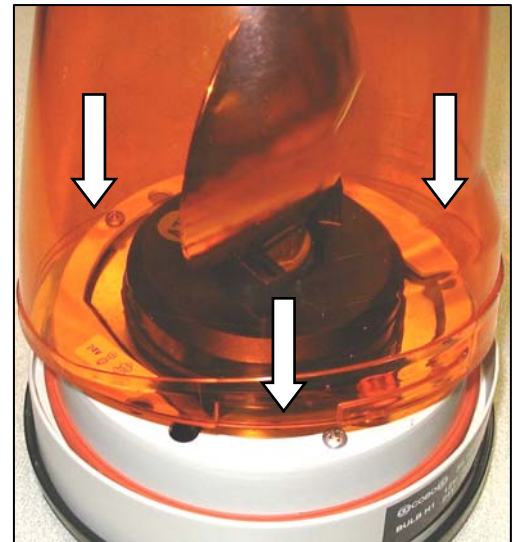

- h. Line-up the three lugs (one is longer) in the base with slots in lens, and seat the lens against the rubber seal.

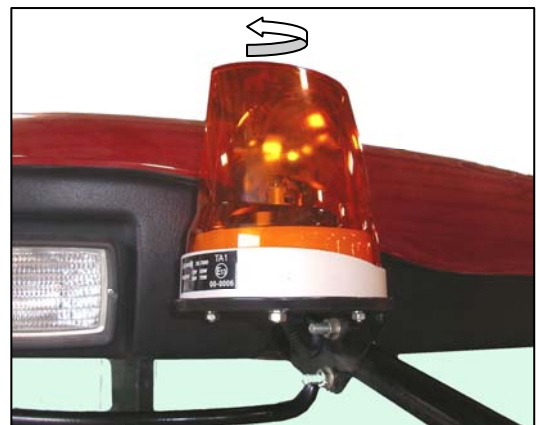

- i. Turn the lens clockwise to lock it in place.

## MAINTENANCE AND SERVICING

### 7.10.9 Dome Light

- a. Shut down engine.

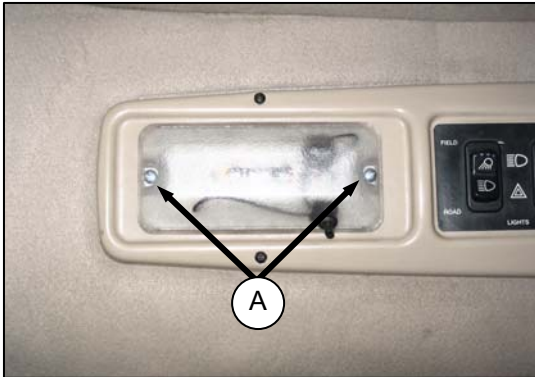

- b. Remove two screws (A) from plastic lens, and remove lens.
- c. Replace bulb.
- d. Re-install plastic lens with screws (A).

### 7.10.10 Ambient Light

- a. Shut down engine.

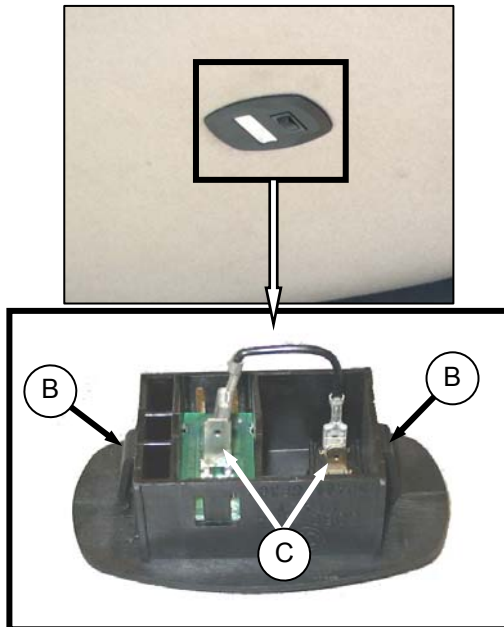

- b. Push against tabs (B) with a screwdriver, and pull ambient light fixture out of cab roof.
- c. Remove wires from connectors (C).
- d. Connect wires to new light fixture.
- e. Push into place in cab roof until tabs (B) hold fixture in place.

### 7.10.11 Turn Signal Indicators

If the turn signal indicators on the CDM do not function, contact your Windrower Dealer.

## MAINTENANCE AND SERVICING

### 7.10.12 Circuit Breakers and Fuses



#### DANGER

Stop engine, and remove key from ignition before leaving Operator's seat for any reason. A child or even a pet could engage an idling machine.

The circuit breakers and fuses are located inside the fuse box that is mounted on the frame on the right side of the windrower.

The circuit breakers automatically reset, and the fuses are the plastic blade type.

Access the breakers and fuses as follows:

- Stop engine, and remove key.

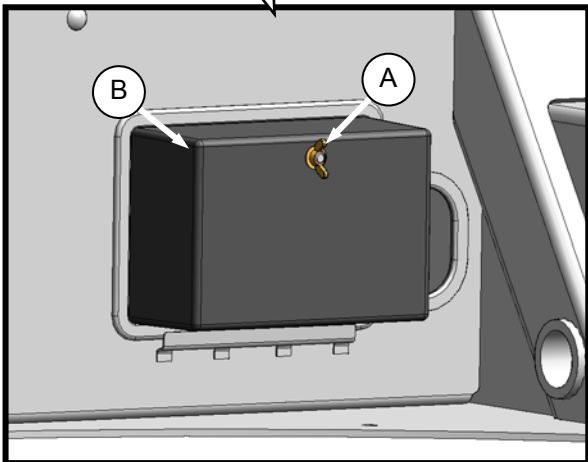
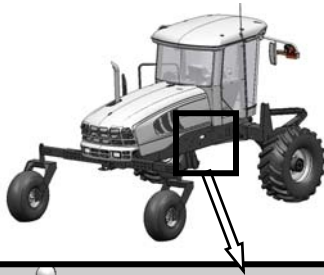

- Remove wing nut (A), and remove fuse box cover (B).
- Refer to decal on inside of cover for identification of fuses and circuit breakers. See illustration on next page.

### 7.10.12.1 Checking/Replacing Fuses

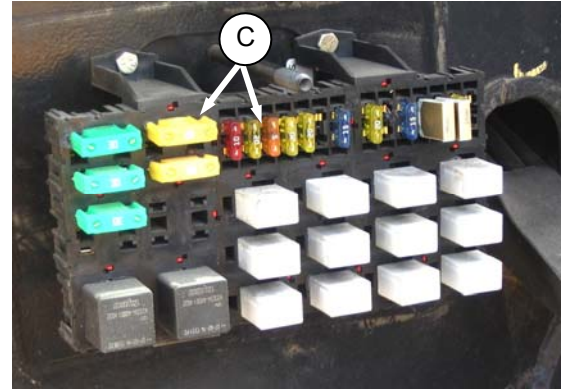

- To check fuse, pull fuse (C) out of receptacle, and visually examine.
- To replace fuse, insert new fuse into receptacle.

#### IMPORTANT

Replacement fuses should match rating on decal shown on following page.

### 7.10.12.2 Replacing Circuit Breakers

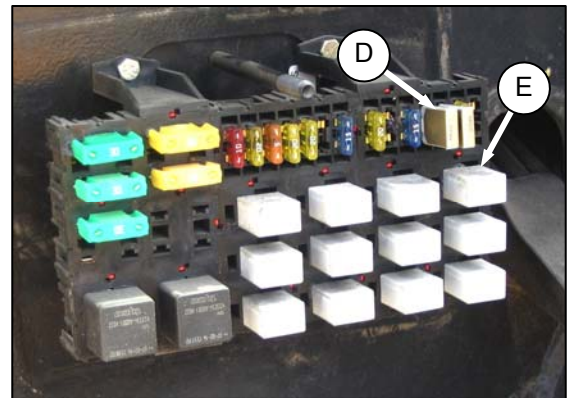

- To replace circuit breaker (D), pull breaker out of receptacle, and install new circuit breaker.
- To replace relay (E), pull relay out of receptacle, and install new relay.
- Re-install cover, and secure with wing nut.

# MAINTENANCE AND SERVICING

## 7.10.12.3 Fuse Box Decal

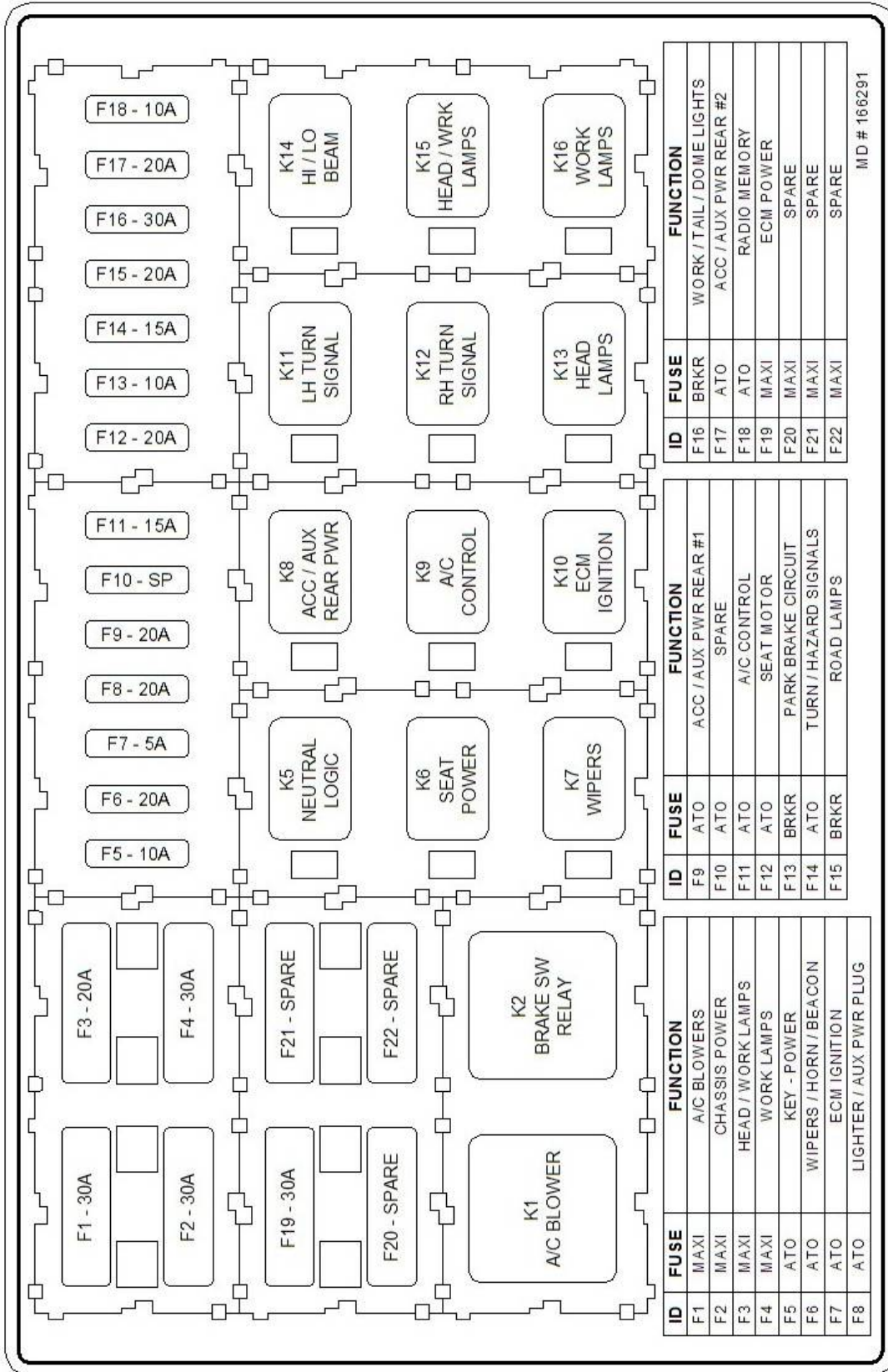

MD # 166291



## MAINTENANCE AND SERVICING

### 7.10.12.4 Main Fuses - 125 Amp

The 125 amp main fuse holders are located inside the frame beside the battery, and are accessed from underneath the windrower.

- a. Stop engine, and remove key.

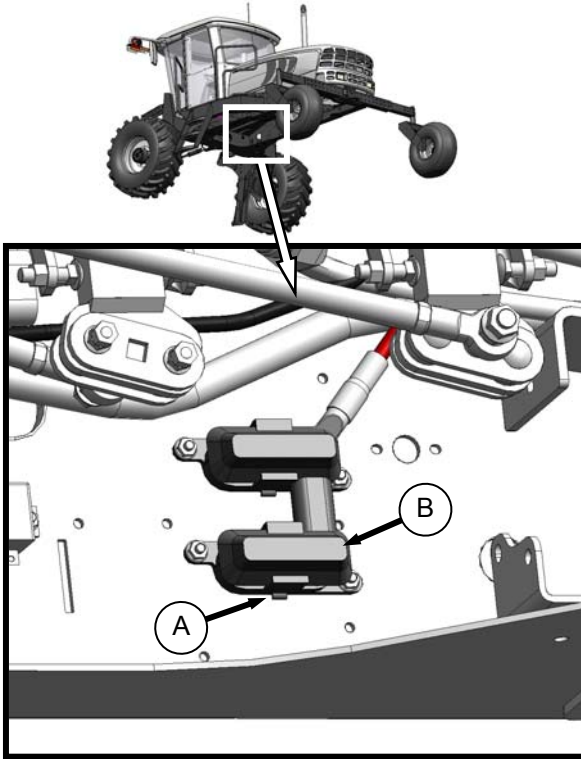

- b. To check condition of fuse, pull tab (A), and open cover (B).

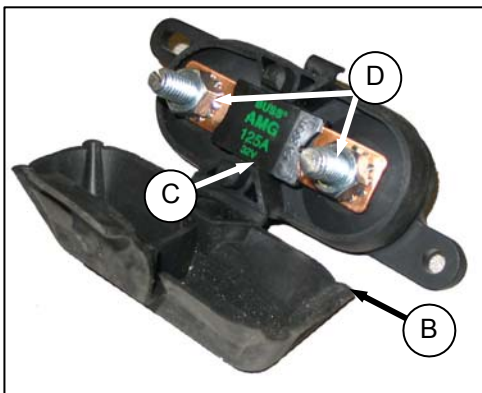

- c. Visually examine fuse (C) for indications of melting.

- d. To remove fuse (C), remove two nuts (D), and pull fuse free from holder. Existing wiring may need to be pulled off the stud first.
- e. Install new fuse on studs, and any existing wiring that was removed.
- f. Secure with nuts (D).
- g. Close cover (B), and secure with tab (A).

## MAINTENANCE AND SERVICING

### 7.11 HYDRAULIC SYSTEM

The M105 Windrower hydraulic system provides oil for the windrower drive system, the header lift, and the drive systems.



#### WARNING

- Avoid high pressure fluids. Escaping fluid can penetrate the skin causing serious injury. Relieve pressure before disconnecting hydraulic lines.
- Tighten all connections before applying pressure. Keep hands and body away from pin-holes and nozzles which eject fluids under high pressure.
- Use a piece of cardboard or paper to search for leaks.
- If ANY fluid is injected into the skin, it must be surgically removed within a few hours by a Doctor familiar with this type of injury, or gangrene may result.

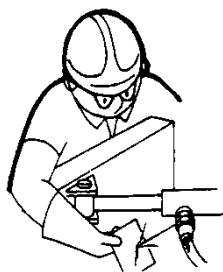

#### IMPORTANT

Dirt, dust, water and foreign material are the major causes of trouble developing in the hydraulic system. If the hydraulic system should be disconnected for service, protect the ends of hoses, tubing and ports of components from contamination with clean, lint-free towels or clean plastic bags.

Before installing any replacement hose, flush the inside of it with unused diesel fuel or unused commercial petroleum cleaning solvent for ten seconds minimum. Do not use water, water soluble cleaners or compressed air.

#### IMPORTANT

The components in this system are built to very close tolerances, and have been adjusted at the factory. Do not attempt to service these components except to maintain proper oil level, change oil and filters and to adjust relief pressures as described in this manual. See your Dealer for all other service.

#### 7.11.1 Oil Level

Check hydraulic oil level daily as follows:



#### DANGER

Stop engine, and remove key from ignition before leaving Operator's seat for any reason. A child or even a pet could engage an idling machine.

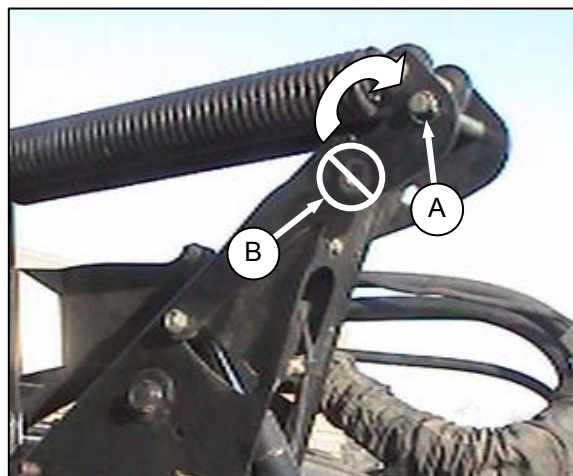

#### IMPORTANT

To prevent damage to the lift system when lowering header lift linkages without a header or weight box attached to windrower, ensure that float engagement pin is installed in storage location (A), and not installed at hole location (B).

- a. Park windrower on level ground, and lower header and reel so that lift cylinders are fully retracted.
- b. Stop engine, and remove key.
- c. Stand on left front side platform to access the filler pipe.



- d. Turn filler cap counter clockwise to loosen bung, and remove dipstick.

*(continued next page)*

## MAINTENANCE AND SERVICING

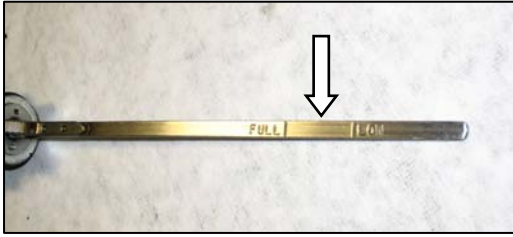

- e. Maintain level between LOW and FULL marks. If necessary, add SAE 15W40 Compliant with SAE Specs for API Class SJ and CH-4 Engine Oil.

### NOTE

*LOW to FULL capacity is approximately 1 U.S. gallon (4 liters).*

- f. Re-install filler cap, and turn clockwise to tighten bung.

### 7.11.2 Changing Hydraulic Oil

#### NOTE

*Change hydraulic oil every 1500 hours or bi-annually.*

- Stop engine, and remove key.
- Open engine compartment hood to highest position.
- Place a suitable container (at least 20 U.S. gallons (75 liters)) under drain to collect oil.



- Remove drain plug from bottom of hydraulic oil reservoir, and allow oil to drain.
- Clean off any metal debris that may have accumulated on magnetic drain plug. Replace and tighten drain plug.

- f. Add oil to the tank to the required level through the filler pipe. 7.11.1 Oil Level.

### 7.11.3 Changing Hydraulic Oil Filters

The supercharge system filter (A) and header drive system filter (B) are located just inside the frame on the left side and are accessible from under the windrower.

#### NOTE

*Change hydraulic oil filters after the first 50 hours of operation, and every 500 hours thereafter. Filter (A) part #112420 and filter (B) part #151975 can be obtained from your Dealer.*

Change as follows:



### DANGER

**Stop engine, and remove key from ignition before leaving Operator's seat for any reason. A child or even a pet could engage an idling machine.**

- Stop engine, and remove key.

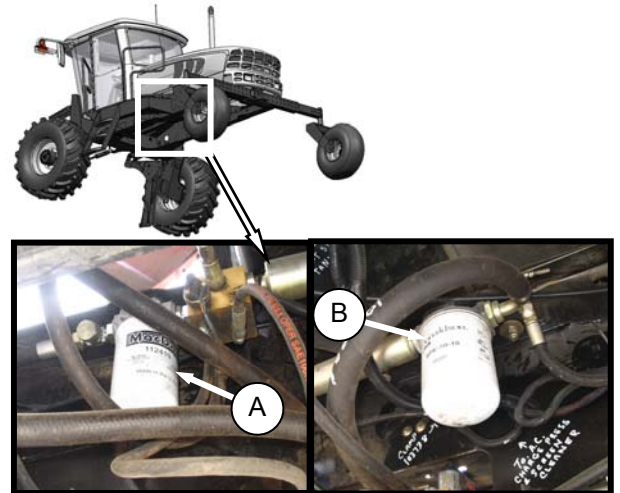

- Clean around heads of the filters (A) and (B).
- Unscrew the filters with a filter wrench.
- Clean the gasket surface of the filter heads.
- Fill new filters with clean oil, and apply a thin film of clean oil to the filter gaskets.
- Screw the new filters onto the mount until the gasket contacts the filter head.
- Tighten filters an additional 1/2 turn by hand.

#### IMPORTANT

Do not use a filter wrench to install oil filter. Over-tightening can damage gasket and filter.

## MAINTENANCE AND SERVICING

### 7.11.4 Header and Reel Hydraulics

#### 7.11.4.1 Pressure Compensator Valve

If lift and drive capacity problems develop, the pressure compensator valve may require adjusting. Contact your Dealer, or refer to the Technical Service Manual for your windrower.

#### 7.11.4.2 Reel/Conveyor Flow Control Block

Two hydraulic valve blocks control the reel and conveyor functions, and are controlled by the Windrower Control Module (WCM) according to the inputs from the Operator.

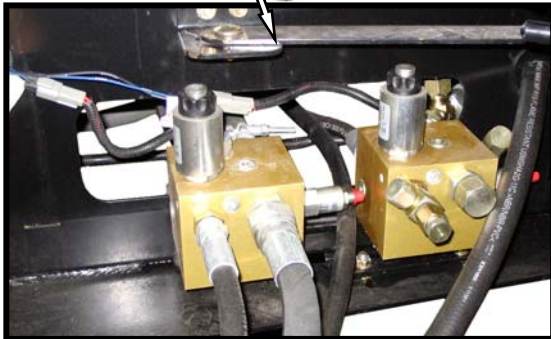

The valve blocks are located behind the maintenance platform.

The valve blocks do not require any scheduled maintenance other than to check for leaking fittings or loose electrical connections.

If service is required, contact your Windrower Dealer or refer to the Technical Service Manual for your Windrower.

#### 7.11.4.3 Knife Drive Valve Block



The ON/OFF valve on the valve block regulates the knife speed, and is mounted on top of the knife drive pump.

The flow to the knife drive is mechanically set on the pump itself.

## MAINTENANCE AND SERVICING

### 7.11.4.4 Header Drop Rate

The header should lower gradually when the lower header switch is pressed. From full height to ground should take approximately 3.5 seconds.

Adjust as follows:



### DANGER

**Stop engine, and remove key from ignition before leaving Operator's seat for any reason. A child or even a pet could engage an idling machine.**

- Lower header to ground, stop engine, and remove key.
- Move maintenance platform rearward.

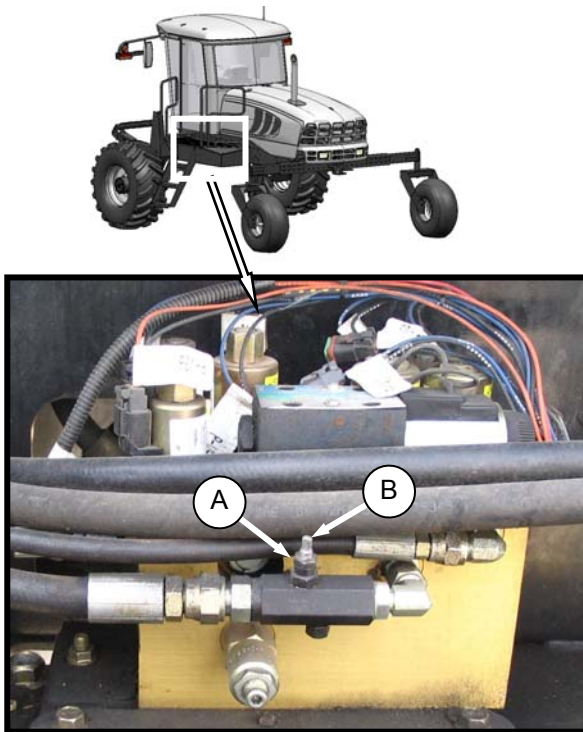

- Loosen jam-nut (A) on needle valve, and turn screw (B) clockwise to decrease the drop rate, or counter clockwise to increase the drop rate.
- Tighten jam-nut (A).
- Close platform and engine compartment hood.
- Check drop rate, and re-adjust as required.

## MAINTENANCE AND SERVICING

### 7.11.5 Traction Drive Hydraulics

#### 7.11.5.1 Transmission Oil Pressure

The windrower transmission consists of two variable displacement axial piston hydraulic pumps - one for each drive wheel. The pumps are driven through a gearbox from the engine.

Each pump requires charge flow to make up for internal leakage, maintain positive pressure in the main circuit, provide flow for cooling and replace any leakage losses from external valving or auxiliary systems.

The charge pressure is monitored, and if it drops below 250 psi (1725 kPa), the CDM sounds a tone, and displays a flashing warning. Refer to Section 5.18.4 *Cab Display Module (CDM) Warnings/Alarms*.

#### IMPORTANT

Rated charge pressure must be maintained under all conditions of operation to prevent damage to the transmission.

If the TRANS OIL PRESSURE warning is displayed, shut down the engine, and proceed as follows:

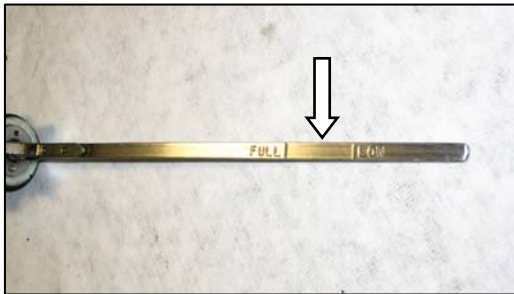

- Check the hydraulic fluid level in the tank. Refer to Section 7.11.1 *Oil Level*.
- Check the hoses and lines for leakage.
- Check the charge pressure relief valve. Refer to following section.
- If charge pressure still cannot be maintained, do not operate the windrower. Contact your Dealer.

#### 7.11.5.2 Charge Pump Pressure

Incorrect charge pressure settings may result in the inability to build required system pressure and/or inadequate loop flushing flows.

Correct charge pressure must be maintained under all conditions to maintain pump control performance, and to operate the brake release.

Check and adjust charge pump pressure as follows:



#### DANGER

**Stop engine, and remove key from ignition before leaving Operator's seat for any reason. A child or even a pet could engage an idling machine.**

- Open engine compartment hood fully.

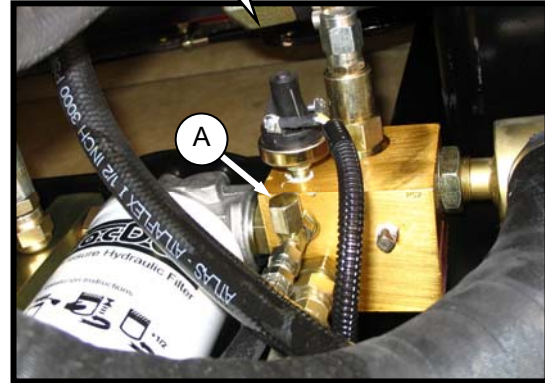

- Remove cap (A) at fitting.
- Attach a 0 - 600 psi (4000 kPa) pressure gauge to a hose that is long enough to allow the pressure gauge to be read from the Operator's seat. Attach hose to the fitting.
- Start engine, and leave at idle. Pressure should be 200 to 250 psi (1379 to 1724 kPa) with the hydraulic oil at 100°F (40°C) minimum.
- If pressure is not within this range, contact your windrower Dealer or refer to the Technical Service Manual.

## MAINTENANCE AND SERVICING

### 7.11.6 Hoses and Lines

Check hydraulic hoses and lines daily for signs of leaks.



#### WARNING

- Avoid high-pressure fluids. Escaping fluid can penetrate the skin causing serious injury. Relieve pressure before disconnecting hydraulic lines. Tighten all connections before applying pressure. Keep hands and body away from pinholes and nozzles which eject fluids under high pressure.



- If ANY fluid is injected into the skin, it must be surgically removed within a few hours by a Doctor familiar with this type of injury or gangrene may result.

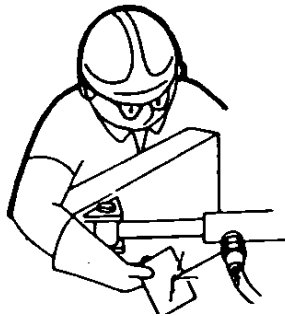

- Use a piece of cardboard or paper to search for leaks.

#### IMPORTANT

Keep hydraulic coupler tips and connectors clean. Dust, dirt, water and foreign material are the major causes of hydraulic system damage.

DO NOT attempt to service hydraulic system in the field. Precision fits require WHITE ROOM CARE during overhaul.

### 7.11.7 Hydraulic Oil Cooler

The hydraulic oil cooler is located inside the cooling box behind the radiator. It should be cleaned daily with compressed air. Refer to Section 7.9.3 *Cooling Box Maintenance*.

## MAINTENANCE AND SERVICING

### 7.12 WHEELS AND TIRES

#### 7.12.1 Drive Wheels

##### 7.12.1.1 Tire Inflation

- a. Visually check daily that tires have not lost pressure. Under-inflation of drive tires can cause side wall cracks.



### DANGER

To avoid severe personal injury or death caused by machine runaway, shut off engine, and remove key before performing any of the following checks and/or adjustments.

- b. Measure tire pressure annually with a gauge. Maintain the pressure as follows:
  1. Determine tire size and type that is installed on your machine.
  2. Refer to Section 4.2 SPECIFICATIONS to determine recommended tire pressure.
  3. Adjust tire pressure as required.



### DANGER

- Never install a tube in a cracked wheel rim.
- Never weld a wheel rim.
- Make sure all the air is removed from a tire before removing the tire from the rim.
- Never use force on an inflated or partially inflated tire. Make sure the tire is correctly seated before inflating to operating pressure.
- Do not remove, install or make repairs to a tire on a rim unless you have the proper equipment and experience to perform the job. Take the tire and rim to a qualified tire repair shop.
- If the tire is not correctly located on the rim, or if too full of air, the tire bead can loosen on one side, causing air to leak at high speed and with great force. An air leak of this nature can thrust the tire in any direction, endangering anyone in the area.
- Do not exceed maximum inflation pressure as per label on tire.

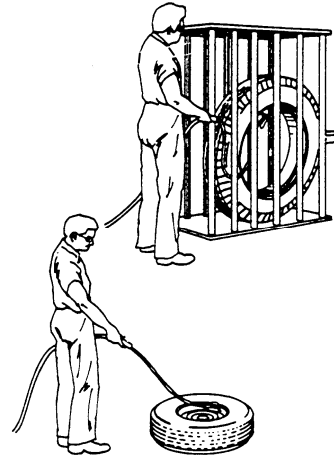

- Use a safety cage if available.
- Do not stand over tire. Use a clip-on chuck and extension hose.

##### 7.12.1.2 Wheel Nut Torque

At first use, or when a wheel is removed, check drive wheel nut torque every 15 minutes on the road, or 1 hour in the field until the specified torque is maintained.

Continue with a checking schedule of 10 and 50 hours (field or road operation), and then every 200 hour intervals thereafter.

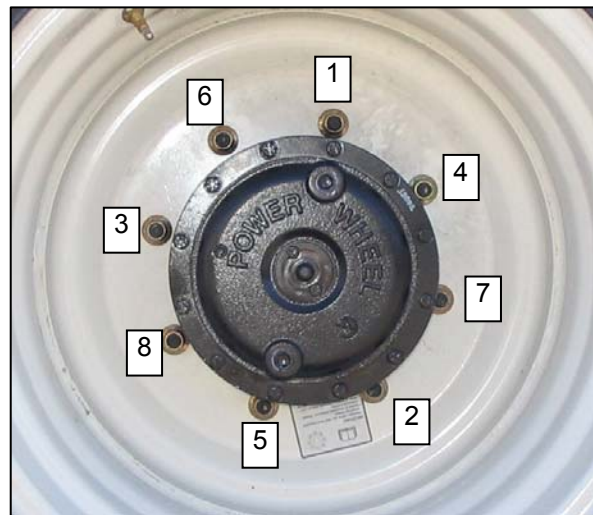

- a. Tighten nuts to 220 ft-lbf (300 N·m) using the tightening sequence as shown above.

#### NOTE

To avoid damage to wheel rims, do not over-tighten wheel nuts.

- b. Repeat sequence three times.



## MAINTENANCE AND SERVICING

### 7.12.1.3 Lubricant

The drive wheel gearbox lubricant should be changed after the first 50 hours.

Check the level every 200 hours or annually, and change every 1000 hours. The windrower should be on level ground when checking lubricant level.

- a. Check the lubricant as follows:

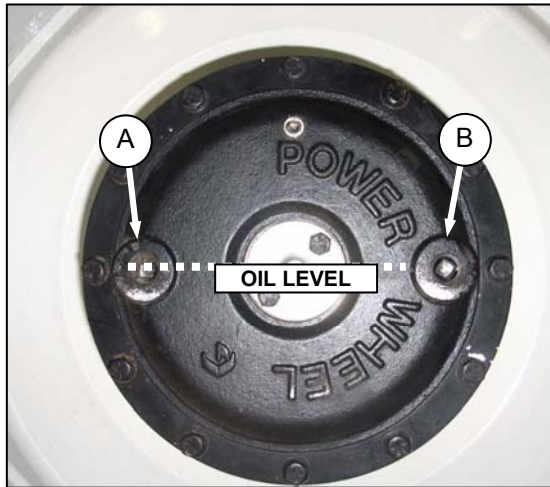

1. Rotate wheel so that one of the plugs (A) is horizontally aligned with the center of the hub.
2. Remove the plug. The oil should be visible through the hole or slightly running out.

#### NOTE

*Type of lubricant used after first lubricant change is different from factory supplied lubricant.*

3. If lubricant needs to be added, remove the second plug (B), and add lubricant until lubricant runs out at (A).

**Prior to first change**, use SAE 85W-140, API Service, Class GL-5, Extreme Pressure Gear Lubricant.

**After first change**, use SAE 75W-90, API Service, Class GL-5, Fully Synthetic Transmission Lubricant (SAE J2360 is preferred).

4. Replace plugs, and tighten.

- b. Change the lubricant as follows:

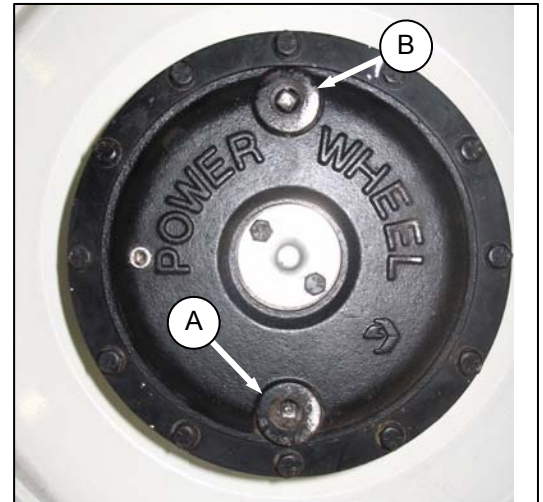

1. Rotate the wheel so that one of the plugs (A) is located at the bottom.
2. Place a large enough container (about 2 quarts U.S. (2 liters) under the drain plug (A).
3. Remove top plug (B), and drain lubricant. Ideally, the lubricant should be at operating temperature for good draining.
4. When lubricant has drained, rotate wheel so that one of the plugs (A) is horizontally aligned with the center of the hub. See illustration opposite.

#### NOTE

*Type of lubricant used after first lubricant change is different from factory supplied lubricant.*

5. Add lubricant through (A) until lubricant runs out of hole at (B). Use SAE 75W-90, API Service, Class GL-5, Fully Synthetic Transmission Lubricant (SAE J2360 preferred). Drive wheel gearbox capacity is 1.5 quarts U.S. (1.4 liters).
6. Replace both plugs, and tighten.

## MAINTENANCE AND SERVICING

### 7.12.1.4 Drive Wheel Removal/Installation



#### DANGER

To avoid severe personal injury or death caused by machine runaway, shut off engine, and remove key before performing any of the following checks and/or adjustments.

- Remove header.
- Park windrower on level ground, and block all wheels.
- Place GSL in N-DETENT, shut down engine, and remove key.

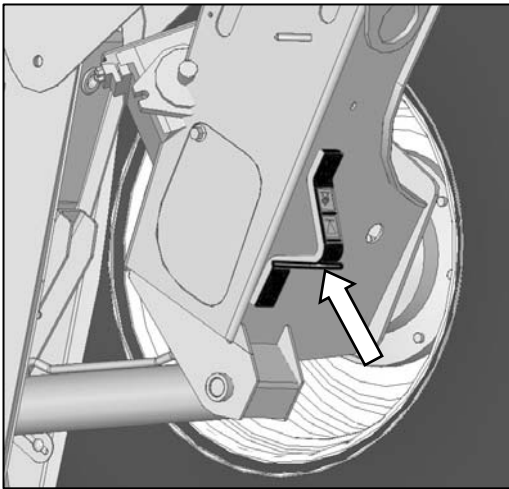

- Jack up windrower under leg jack point, and raise windrower wheel slightly off ground.

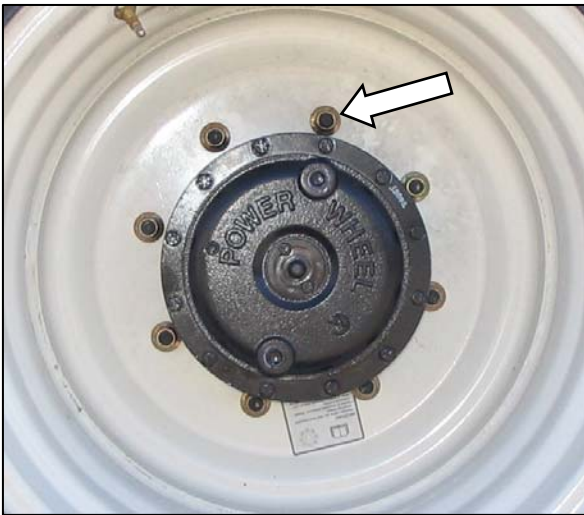

- Undo wheel nuts, and remove wheel.

- To install new tire, ensure that air valves are on the outside, and tire tread points forward.

For Turf tires (diamond tread), be sure arrow on sidewall points in forward rotation.

- Place wheel on hub, and install wheel nuts.

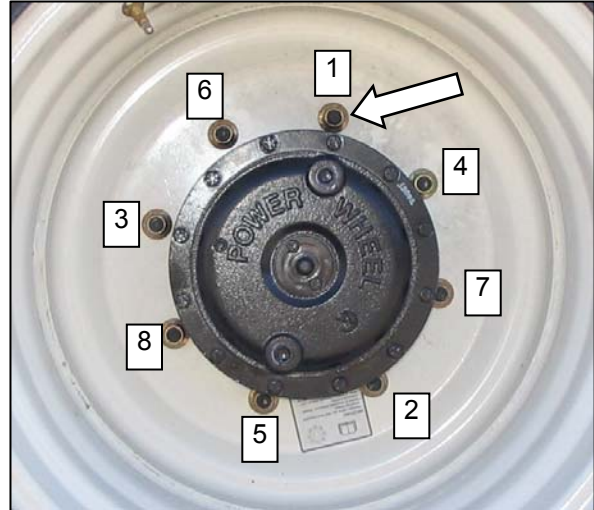

- Tighten nuts to 220 ft-lbf (300 N-m) using the tightening sequence as shown above.

#### NOTE

To avoid damage to wheel rims, do not over-tighten wheel nuts.

- Repeat sequence three times.
- Lower windrower, and remove jack.

## MAINTENANCE AND SERVICING

### 7.12.2 Caster Wheels

#### 7.12.2.1 Tire Inflation

- a. Visually check daily that tires have not lost pressure. Under-inflation of drive tires can cause side wall cracks.



### DANGER

To avoid severe personal injury or death caused by machine runaway, shut off engine, and remove key before performing any of the following checks and/or adjustments.

- b. Measure tire pressure annually with a gauge. Maintain the pressure as shown in Section 4.2 SPECIFICATIONS.

#### NOTE

*If caster wheels shimmy, a possible cause is over-inflation.*



### DANGER

- Never install a tube in a cracked wheel rim.
- Never weld a wheel rim.
- Make sure all the air is removed from a tire before removing the tire from the rim.
- Never use force on an inflated or partially inflated tire. Make sure the tire is correctly seated before inflating to operating pressure.
- Do not remove, install or make repairs to a tire on a rim unless you have the proper equipment and experience to perform the job. Take the tire and rim to a qualified tire repair shop.
- If the tire is not correctly located on the rim, or if too full of air, the tire bead can loosen on one side, causing air to leak at high speed and with great force. An air leak of this nature can thrust the tire in any direction, endangering anyone in the area.

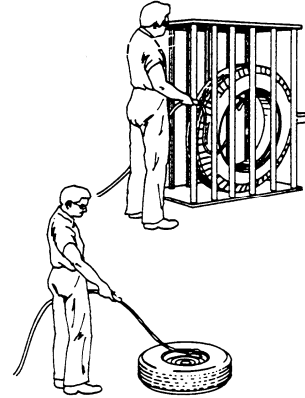

- Use a safety cage if available.
- Do not stand over tire. Use a clip-on chuck and extension hose.

## MAINTENANCE AND SERVICING

### 7.12.2.2 Ballast Requirements

Fluid ballasting of rear caster tires is recommended to provide adequate machine stability when using large headers on the windrower. Also, the stability of machine varies with different attachments, windrower options, terrain and Operator's driving technique.

Ballast capability per tire is at a maximum fill of 75%, or when fluid is level with valve stem when the stem is positioned at 12 o'clock. Fluid can be added to any level up to maximum fill. Always add an equal amount of fluid on both sides.

TIRE SIZE	FLUID PER TIRE AT 75% FILL U.S. Gal. (Liters)	TOTAL WEIGHT OF BOTH TIRES lb (kg) *
7.5X16	10 (38)	200 (91)
10X16	18 (69)	380 (170)
16.5X16.1	41 (158)	830 (377)

\* Weights are given for typical calcium chloride and water mixtures. Weight is reduced by 20% if only water is used (for areas that do not require anti-freeze protection).

HEADER DESCRIPTION		RECOMMENDED BALLAST				RECOMMENDED TIRE SIZE
		LEVEL GROUND		HILLS		
TYPE	SIZE (FT)	PER TIRE	BOTH TIRES	PER TIRE	BOTH TIRES	
		U.S. Gal. (Liters)	lb (kg) *	U.S. Gal. (Liters)	lb (kg) *	
A, D Series All Options	25 FT and Down	0	0	0	0	7.5X16 10X16 16.5X16.1
D Series	30 FT Single or Split Reel without Conditioner	0	0	10 (38)	200 (91)	
	35 FT Single Reel					
D Series	30 FT Split Reel. Steel Fingers and Conditioner.	18 (69)	380 (170)	30 (115)	630 (288)	Level Ground - 10X16 16.5X16.1
	35 FT Split Reel (5 or 6 Bat)					Hills - 16.5X16.1

\* If only water is used, increase volume of water by 20% (up to maximum allowable fill per tire) to compensate.

## MAINTENANCE AND SERVICING

### 7.12.2.3 Wheel Nut Torque

At first use, or when a wheel is removed, check caster wheel bolt torque as follows after 5 hours, and then at 200 hour intervals:

#### NOTE

To avoid damage to wheel rims, do not over-tighten wheel nuts.

#### Forked Casters

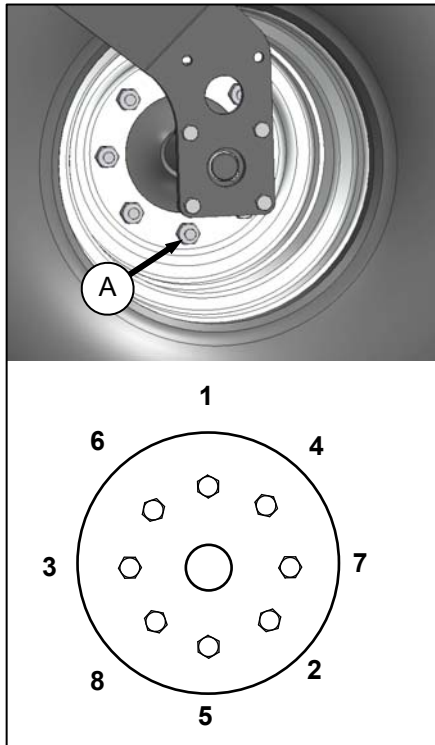

- Tighten nuts (A) to 120 ft-lbf (163 N-m) using the tightening sequence as shown above.
- Repeat sequence three times.

#### Formed Casters

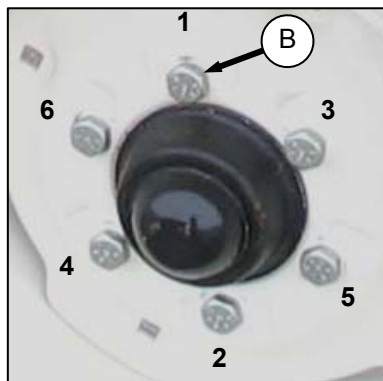

- Tighten bolts (B) to 120 ft-lbf (163 N-m) using the tightening sequence as shown.
- Repeat sequence three times.

### 7.12.2.4 Forked Caster Wheel Removal and Installation



#### DANGER

To avoid severe personal injury or death caused by machine runaway, shut off engine, and remove key before performing any of the following checks and/or adjustments.

- Remove the caster wheel as follows:
  - Park windrower on level ground, and block all wheels.
  - Place GSL in N-DETENT, shut down engine, and remove key.
  - Raise end of walking beam using a jack (4000 lb (1816 kg) capacity) (or other suitable lifting device) until the wheel is slightly off the ground.

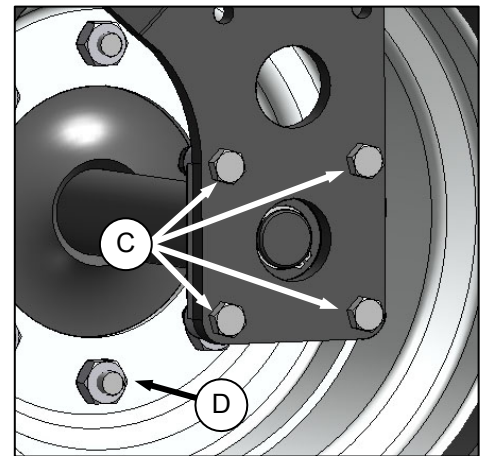

- Remove the eight bolts (C) attaching axle to forked caster, and remove wheel assembly from caster.
  - Undo the eight wheel nuts (D), and remove wheel from axle.
- Install the caster wheel as follows:
    - Place wheel on axle, and install wheel nuts (D).
    - Torque nuts (D) as specified in previous section. Refer to Section 7.12.2.3 Wheel Nut Torque.
    - Position wheel assembly in forked caster, and install with bolts (C). Torque bolts to 75 - 79 ft-lbf (97 - 107 N-m).
    - Lower windrower, and remove jack.

## MAINTENANCE AND SERVICING

### 7.12.2.5 Formed Caster Wheel Removal and Installation



#### DANGER

To avoid severe personal injury or death caused by machine runaway, shut off engine, and remove key before performing any of the following checks and/or adjustments.

- a. Remove the caster wheel as follows:
  1. Park windrower on level ground, and block all wheels.
  2. Place GSL in N-DETENT, shut down engine, and remove key.
  3. Raise end of walking beam using a jack (4000 lb (1816 kg) capacity) (or other suitable lifting device) until the wheel is slightly off the ground.



4. Undo the six wheel bolts (A), and remove wheel from hub.
- b. Install the caster wheel as follows:
  1. Place wheel on hub, and install wheel bolts (A).
  2. Torque bolts (A) to 120 ft·lbf (163 N·m) using the tightening sequence as shown on previous page.
  3. Lower windrower, and remove jack.

### 7.12.2.6 Caster Wheels Anti-Shimmy Dampeners

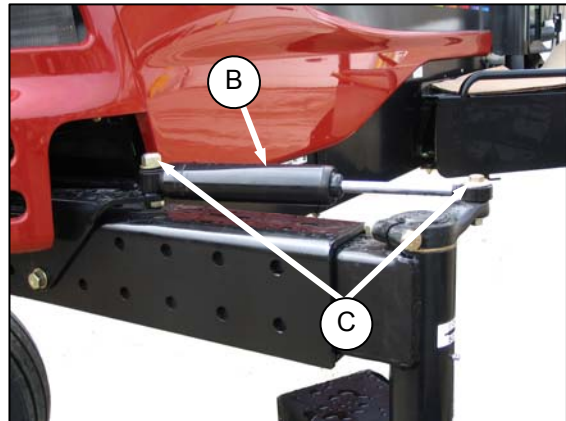

Each caster is equipped with a fluid filled anti-shimmy dampener (B).

The mounting bolts (C) need to be checked periodically for security. Refer to Section 7.4.1 *Maintenance Schedule / Report*.

- Inboard bolt should be tightened to 100 ft·lbf (135 N·m).
- Outboard bolt should be tightened to 85 ft·lbf (115 N·m).

# TROUBLESHOOTING

## 8 TROUBLESHOOTING

### 8.1 ENGINE

SYMPTOM	PROBLEM	SOLUTION	SECTION
<b>Engine Hard To Start or Will Not Start.</b>	Controls not in NEUTRAL.	Move GSL to NEUTRAL.	6.3.4.1
		Move steering wheel to locked position.	
		Disengage header drive/clutch.	5.17.1
	No fuel to engine.	Fill empty fuel tank, replace clogged fuel filter.	6.3.5.4 7.8.6.2
	Old fuel in tank.	Drain tank, refill with fresh fuel.	7.8.6
	Water, dirt or air in fuel system.	Drain, flush, fill and prime system.	
	Improper type of fuel.	Use proper fuel for operating conditions.	7.3.2.1
	Crankcase oil too heavy.	Use recommended oil.	7.3.2.3
	Low battery output.	Have battery tested. Check battery electrolyte level.	7.10.1
	Poor battery connection.	Clean and tighten loose connections.	
	Loose electrical connection at fuel pump.	Ensure connector at pump is fully pushed in.	---
	Wiring shorted, circuit breaker open.	Check continuity of wiring and breaker (manual reset).	7.10.12
	ECM fuse (1 of 2) blown.	Replace.	
	ECM Ignition relay faulty.		
	Neutral Logic relay faulty.		
	Neutral Interlock misadjusted.	Contact your Dealer.	*
Faulty starter.			
Faulty injectors.			
<b>Engine Knocks.</b>	Engine out of time.		
	Insufficient oil.	Add oil.	7.8.3
	Low or high coolant temperature.	Remove and check thermostat. See Engine Overheats in Technical Manual.	**
	Improper fuel.	Use proper fuel.	7.3.2.1
<b>Low Oil Pressure.</b>	Low oil level.	Add oil.	7.8.3
	Improper type of oil.	Drain, fill crankcase with proper oil.	7.8.4
	Worn components.	Contact your Dealer.	*
<b>High Oil Consumption.</b>	Internal parts worn.		
	Crankcase oil too light.	Use recommended oil.	7.3.2.3
	Oil leaks.	Check for leaks around gaskets, seals, and drain plugs.	7.8.4

*(continued next page)*

\* See Your MacDon Dealer

\*\* Refer to Windrower Technical Manual

## TROUBLESHOOTING

SYMPTOM	PROBLEM	SOLUTION	SECTION
<b>Engine Runs Irregularly or Stalls Frequently.</b>	Unsteady fuel supply.	Change filter on fuel tank vent line. Replace clogged fuel filter.	7.8.6.1 7.8.6.2
	Water or dirt in fuel system.	Drain, flush, and fill system.	7.8.6.3
	Low coolant temperature.	Remove and check thermostat.	**
	Air in fuel system.	Contact your Dealer.	*
	Dirty or faulty injectors.		
<b>Lack Of Power.</b>	Incorrect timing.	Contact your Dealer.	*
	Improper valve clearance.		
	Faulty injectors.		
	Engine oil viscosity too high.	Use recommended oil.	7.3.2.3
	Intake air restriction.	Service air filter/cleaner.	7.8.5.1
	Clogged fuel filter.	Replace primary fuel filter and if necessary, replace secondary fuel filter.	7.8.6.2
	High back pressure.	Clean out muffler.	7.8.9
	Improper type of fuel.	Use proper fuel.	7.3.2.1
	High or low engine temperature.	Remove and check thermostat. See Engine Overheats in Technical Manual.	**
<b>Engine Temperature Below Normal.</b>	Defective thermostat.	Remove and check thermostat.	*
<b>Warning Alarm Sounds.</b>	Engine overheated.	Check coolant level.	7.8.7
		Check thermostat.	**
	Low engine oil pressure.	Check oil level.	7.8.3
	Low transmission oil pressure.		7.11.1
<b>Engine Overheats.</b>	Low coolant level.	Fill reserve tank to proper level. Check system for leaks.	7.8.7
	Water only for coolant.	Replace with antifreeze.	
	Engine overloaded.	Reduce ground speed.	6.3.5.2
	Defective radiator cap.	Replace cap.	7.8.7.2
	Defective fan belt.	Replace belt.	7.8.10.3
	Dirty radiator screen: • Rotors turning	Check for obstructions in ducting from screen to fan shroud.	7.9.1
		• Rotors not turning	
	Dirty radiator core.	Clean radiator.	7.9.3
	Cooling system dirty.	Flush cooling system.	
	Defective thermostat.	Remove and check thermostat.	**
	Defective temperature gauge or sender.	Check coolant temperature with thermometer. Replace gauge if necessary.	*
Defective water pump.	Contact your Dealer.		

*(continued next page)*

\* See Your MacDon Dealer

\*\* Refer to Windrower Technical Manual



## TROUBLESHOOTING

SYMPTOM	PROBLEM	SOLUTION	SECTION
<b>High Fuel Consumption.</b>	Improper type of fuel.	Use proper fuel.	7.3.2.1
	Clogged or dirty air cleaner.	Service air filter/cleaner.	7.8.5.1
	Engine overloaded.	Reduce ground speed.	6.3.5.2
	Low engine temperature.	Check thermostat.	**
	Improper valve clearance.	Reset valves.	*
	Engine out of time.	Contact your Dealer.	
	Injection nozzles dirty.		
<b>Engine Emits Black or Grey Exhaust.</b>	Improper type of fuel.	Consult your fuel supplier, and use proper type fuel for conditions.	7.3.2.1
	Engine overloaded.	Reduce ground speed.	6.3.5.2
	Clogged or dirty air cleaner.	Service air filter/cleaner.	7.8.5.1
	Defective muffler.	Check muffler for possible damage that might create back pressure.	7.8.9
	Dirty or faulty injectors.	Contact your Dealer.	*
	Engine out of time.		
	Air in fuel system.		
<b>Engine Emits White Exhaust.</b>	Engine out of time.		
	Improper type of fuel.	Consult your fuel supplier, and use proper type fuel for conditions.	7.3.2.1
	Cool engine.	Warm engine up to normal operating temperature.	6.3.4.1
	Defective thermostat.	Remove and check thermostat.	**
<b>Starter Cranks Slowly or Will Not Operate.</b>	Low battery output.	Check battery charge.	7.10.1.1
	Controls not in NEUTRAL.	Move GSL to NEUTRAL.	6.3.5.2
		Move steering wheel to CENTER position.	6.3.4.1
		Disengage header.	5.17.1
	Loose or corroded battery connections.	Clean and tighten loose connections.	7.10.1.1
	Crankcase oil too high viscosity.	Use recommended oil.	7.3.2.3
	Relay not functioning.	Check relay and wire connections.	7.10.12
	Main fuse defective/blown.	Replace main fuse.	
	Key power fuse blown.	Replace.	
	Key switch worn or terminals loose.	Contact your Dealer.	*
Switch at interlock not closed or defective.	Adjust switch or replace.		
<b>Air Filters Require Frequent Cleaning.</b>	Aspirator plugged.	Clean out aspirator	7.8.5.1
	Pre-cleaner rotor not turning freely.	Repair / replace.	7.9.1

\* See Your MacDon Dealer

\*\* Refer to Windrower Technical Manual

## TROUBLESHOOTING

### 8.2 ELECTRICAL

SYMPTOM	PROBLEM	SOLUTION	SECTION
<b>Low Voltage and/or Battery Will Not Charge.</b>	Defective battery.	Have battery tested.	7.10.1.1
	Loose or corroded connections.	Clean and tighten battery connections.	
	Defective alternator belt.	Replace worn belt.	7.8.10.3
	Alternator or voltage regulator not connected properly.	Connect properly.	7.10.1.6
	Dirty or defective alternator, defective voltage regulator, or high resistance in circuit.	Contact your Dealer.	*
<b>Lights Dim.</b>	Defective light switch.		
	High resistance in circuit or poor ground on lights.	Check the wiring circuit for a break in a wire or a poor ground.	---
<b>Lights Do Not Light.</b>	Burned out light bulb.	Replace light bulb.	7.10.2 to 7.10.11
	Broken wiring.	Check wiring for broken wire or shorts.	---
	Poor ground on lights.	Clean and tighten ground wires.	
	Open or defective circuit breaker.	Check circuit breaker	7.10.12
	Defective relay.	Replace relay.	
	Defective light switch.		
<b>Turn Signals or Indicators Showing Wrong Direction.</b>	Reversed wires.	Contact your Dealer.	*
<b>No Current To Cab.</b>	Broken or disconnected wire.		
	Circuit breaker tripped.	Breaker automatically resets.	---
	Battery disconnect switch is OFF.	Turn switch ON.	7.10.1

### 8.3 HYDRAULICS

SYMPTOM	PROBLEM	SOLUTION	SECTION
<b>Header or Reel Not Lifting.</b>	Contaminant in relief valve.	Clean relief valve at cylinder control valve.	**
	Appropriate solenoids not being energized by activating switch.	Contact your Dealer.	*
<b>Header or Reel Lifts But Lacks Power.</b>	Relief pressure too low or contaminant in relief valve.	Check/adjust/clean relief valve at cylinder control valve.	**
<b>Header or Reel Lifts Unevenly.</b>	Air in system.	Fully raise header or reel and hold switch.	6.4.1
<b>Reel and/or Conveyor Not Turning.</b>	HEADER DRIVE switch not engaged.	Engage switch.	5.17.1
	Flow controls adjusted too low.	Toggle speed controls on CDM to increase flow.	6.5.7 & 6.5.8, 6.6.2 & 6.6.3
	Appropriate solenoid on flow control block not being energized.	Contact your Dealer.	*
<b>Reel and/or Conveyor Turns But Lacks Power.</b>	Relief pressure too low.	Check / adjust / clean relief valve.	**

\* See Your MacDon Dealer

\*\* Refer to Windrower Technical Manual

## TROUBLESHOOTING

### 8.4 HEADER DRIVE

SYMPTOM	PROBLEM	SOLUTION	SECTION
<b>Header Drive Not Engaging.</b>	HEADER DRIVE switch in cab not engaged.	Engage switch.	5.17.1
	Operator Presence Switch not closed or faulty.	Occupy Operator's seat or replace switch.	*
	Appropriate solenoid not being energized by activating switch.	Contact your Dealer.	
<b>Header Drive Lacks Power.</b>	Relief valve setting too low.		6.3.5.2
	Header drive overload.	Reduce ground speed.	
<b>Warning Alarm Sounds.</b>	Relief valve setting too low.	Contact your Dealer.	*

### 8.5 TRACTION DRIVE

SYMPTOM	PROBLEM	SOLUTION	SECTION
<b>Warning Alarm Sounds and Hydraulic Oil Light Is ON.</b>	Low hydraulic oil level.	Stop engine, and add oil to hydraulic system.	7.11.1
	Low hydraulic pressure.	Contact your Dealer.	*
	Foreign material shorting sender.		
	Short in alarm wiring.		
	Faulty sender.		
<b>Wheels Lack Pulling Ability On A Grade or Pulling Out Of A Ditch.</b>	Internal pump or motor damage.		
	Insufficient torque at drive wheels.	Switch speed range control to Mode 1 - Field, and reduce ground speed.	6.3.5.2
	Loose or worn controls.	Check controls.	7.7.3
	Air in system.	Use proper oil.	7.3.2.3
		Check oil level and leaks.	7.11.1
		Check hydraulic oil filters.	7.11.3
	Brakes binding or not releasing fully.	Check pressure (minimum 200 psi (1379 kPa)) on brake release valve.	**
Relief valve in tandem pump dirty or damaged.	Replace relief valve.		

*(continued next page)*

\* See Your MacDon Dealer

\*\* Refer to Windrower Technical Manual

## TROUBLESHOOTING

SYMPTOM	PROBLEM	SOLUTION	SECTION
<b>Both Wheels Will Not Pull In Forward or Reverse.</b>	Pump arms have broken shaft or loose hardware.	Repair or tighten.	**
	Brakes binding or not releasing fully.	Check pressure (minimum 200 psi (1379 kPa)) on brake release valve.	
	Low oil level.	Check oil reservoir level.	7.11.1
	Power hubs (final drives) disengaged.	Engage power hubs (final drives).	6.3.8.1
	Damaged hydraulic lines preventing proper oil flow.	Replace damaged lines.	*
	Steering controls worn or defective.	Check GSL and steering for loose, worn or damaged ball joints and connecting rods.	7.7.3 & 7.7.4
	Charge pressure relief valve misadjusted or damaged.	Check the valve adjustment. Check valve parts and seat.	7.11.5.2
	Speed-range control not working.	Contact your Dealer.	*
	Failed pump or motor.		
<b>One Wheel Does Not Pull In Forward or Reverse.</b>	One final drive disengaged.	Engage final drive.	6.3.8.1
	Steering controls worn or defective.	Check GSL and steering for loose, worn or damaged ball joints and connecting rods.	7.7.3 & 7.7.4
	Brakes binding or not releasing fully.	Check pressure (minimum 200 psi (1379 kPa)) on brake release valve.	**
	High pressure relief valve stuck open, damaged seat.	Check valve and clean or replace.	
	Pump arm or shaft is broken.	Contact your Dealer.	*
	Damaged hydraulic lines preventing proper oil flow.		
	Speed-range control not working.		
	Failed pump, motor or power hub.		
Leakage at pump or motor.			
<b>With Steering Wheel Centered, One Wheel Pulls More Than The Other.</b>	Wheels not in same speed range.	Repair or replace valve.	*
	Faulty relief valve.		
<b>Excessive Noise From Drive System.</b>	Hydraulic line clamps loose.	Tighten clamps.	---
	Air in system.	Check lines for leakage.	
	Mechanical interference in steering or ground speed linkage.	Adjust, repair, replace.	7.7.3 & 7.7.4
	Brakes binding or not releasing fully.	Check pressure (minimum 200 psi (1379 kPa)) on brake release valve.	**
	Faulty pump or motor.	Contact your Dealer.	*
<b>Hydraulic Oil Filter Leaks At Seal.</b>	Not properly tightened.	Tighten filter element.	7.11.3
	Damaged seal or threads.	Replace filter or filter head.	

\* See Your MacDon Dealer

\*\* Refer to Windrower Technical Manual

## TROUBLESHOOTING

### 8.6 STEERING AND GROUND SPEED CONTROL

SYMPTOM	PROBLEM	SOLUTION	SECTION
<b>Machine Will Not Steer Straight.</b>	Linkage worn or loose.	Replace worn parts. Adjust linkage.	7.7.4.1
<b>Machine Moves on Flat Ground With Controls In NEUTRAL.</b>	Neutral interlock misadjusted.	Contact your Dealer.	*
	Parking brake not functioning.		
	GSL cable misadjusted.		
<b>Steering Wheel Will Not Lock With GSL In N-DETENT.</b>	Transmission interlock misadjusted.		
<b>Steering Wheel Will Not Unlock.</b>	Transmission interlock cylinder not working.		
<b>Insufficient Road Speed.</b>	Speed-range control in mode1 - Field: (0 - 11mph (17.7 km/h)).	Switch to Mode 2 - Road (0 - 16 mph (25.7 km/h)).	6.3.5.2

### 8.7 CAB AIR

SYMPTOM	PROBLEM	SOLUTION	SECTION
<b>Blower Fan Will Not Run.</b>	Burned out motor.	Contact your Dealer.	*
	Burned out switch.		
	Motor shaft tight or bearings worn.		
	Faulty wiring - loose or broken.		
	Blower rotors in contact with housing.		
<b>Blower Fan Operating But No Air Coming Into Cab.</b>	Dirty fresh air filter.	Clean fresh air filter.	7.7.6.1
	Dirty recirculating air filter.	Clean recirculating (return) air filter	7.7.6.2
	Evaporator clogged.	Clean evaporator.	7.7.6.4
	Air flow passage blocked.	Remove blockage.	---
<b>Heater Not Heating.</b>	Heater shut-off valve at engine closed.	Open valve.	5.10.3
	Defective thermostat in engine water outlet manifold.	Replace thermostat.	**
	Heater temperature control defective.	Replace control.	
	No thermostat in engine water outlet manifold.	Install thermostat.	
<b>Odor From Air Louvers.</b>	Dirty filters.	Clean fresh air and re-circulation filters.	
	Plugged drainage hose.	Blow out hose with compressed air.	
<b>Air Conditioning Not Cooling.</b>	Blower motor disconnected or burned out.	Contact your Dealer.	*
	Switch contacts in thermostat burned excessively or sensing element defective.	Replace thermostat.	**
	Low refrigerant level.	Add refrigerant	**

*(continued next page)*

\* See Your MacDon Dealer

\*\* Refer to Windrower Technical Manual

## TROUBLESHOOTING

SYMPTOM	PROBLEM	SOLUTION	SECTION
<b>Air Conditioning Not Cooling. (Cont'd)</b>	Clutch coil burned out or disconnected.	Contact your Dealer.	*
	Broken or disconnected electrical wire.	Check all terminals for loose connections. Check wiring for hidden breaks.	**
	Broken or disconnected ground wire.	Check ground wire to see if loose, broken, or disconnected.	**
	Condenser fins plugged.	Clean condenser.	7.9.3
	Loose or broken drive belt.	Replace drive belt and/or tighten to specifications.	7.8.10.3
	Plugged filters.	Clean fresh air and recirculating filters.	7.7.6
	Compressor partially or completely seized.	Remove compressor for service or replacement.	**
	Expansion valve stuck in open or closed position.	Contact your Dealer.	*
	Broken refrigerant line.		
	Leak in system.		
	Compressor shaft seal leaking.		
	Clogged screen in receiver-drier; plugged hose or coil.		
<b>Air Conditioning Producing Insufficient Cooling.</b>  <i>Sufficient Cooling Defined As When Air Temperature In Cab, Measured At Louvered Vent, Can Be Maintained At 25F° (14C°) Below Ambient Air Temperature.</i>	Refrigerant low.	Contact your Dealer.	*
	Clogged expansion valve.		
	Clogged receiver-drier.		
	Excessive moisture in system.		
	Air in system.		
	Blower motor sluggish in operation.		
	Compressor clutch slipping.	Remove clutch assembly for service or replacement.	**
	Clogged air filters.	Remove air filters. Clean or replace as necessary.	7.7.6.1 & 7.7.6.2
	Heater circuit is open.	Close heater valves (1 in cab and 1 at engine).	5.10.1 5.10.3
	Insufficient air circulation over condenser coil; fins clogged with dirt or insects.	Clean condenser.	7.9.3
	Evaporator fins clogged.	Clean evaporator fins (under cab floor).	7.7.6.4
	Thermostat defective or improperly adjusted.	Replace thermostat.	**

*(continued next page)*

\* See Your MacDon Dealer

\*\* Refer to Windrower Technical Manual

## TROUBLESHOOTING

SYMPTOM	PROBLEM	SOLUTION	SECTION
<b>Air Conditioning System Too Noisy.</b>	Defective winding or improper connection in compressor clutch coil or relay.	Contact your Dealer.	*
	Excessive charge in system.		
	Low charge in system.		
	Excessive moisture in system.		
	Noisy clutch.	Remove clutch for service or replacement as required.	
	Noisy compressor.	Check mountings and repair. Remove compressor for service or replacement.	
	Compressor oil level low.	Add SP-15 PAG refrigerant oil.	
	Blower fan noisy due to excessive wear.	Remove blower motor for service or replacement as necessary.	
	Loose or excessively worn drive belt.	Tighten or replace as required.	
<b>Air Conditioning Cools Intermittently.</b>	Compressor clutch slipping.	Contact your Dealer.	*
	Unit icing up due to: <ul style="list-style-type: none"> <li>• Thermostat adjusted too low.</li> <li>• Excessive moisture in system.</li> <li>• Incorrect super-heat adjustment in the expansion valve.</li> </ul>	Adjust thermostat.	**
	Thermostat defective.	Contact your Dealer.	*
	Defective blower switch or blower motor.		
	Partially open, improper ground or loose connection in compressor clutch coil.		
<b>Windows Fog Up.</b>	High humidity.	Run A/C to de-humidify air, and heater to control temperature.	5.10.1

### 8.8 OPERATOR'S STATION

SYMPTOM	PROBLEM	SOLUTION	SECTION
<b>Rough Ride.</b>	Seat suspension not adjusted for Operator's weight.	Adjust seat suspension.	5.2
	High air pressure in tires.	Deflate to proper pressure.	4.2, 7.12.1 & 7.12.2

\* See Your MacDon Dealer

\*\* Refer to Windrower Technical Manual

## OPTIONS / ATTACHMENTS

### 9 OPTIONS / ATTACHMENTS

#### 9.1 REEL DRIVE AND LIFT PLUMBING

Reel drive and lift plumbing for draper headers on windrowers that are shipped from the factory in auger header configuration. Installation instructions are included.

#### 9.2 WINDROWER HYDRAULIC COMPLETION FOR DRAPER HEADER REEL FORE-AFT

Allows reel fore-aft hydraulic adjustment for draper headers on windrowers that are shipped from the factory in auger header configuration. Kit includes valve for selection of reel fore-aft or double windrow attachment functions. Installation instructions are included.

#### 9.3 BOOSTER SPRING KIT

Available for headers over 6000 lb (2724 kg). Installation instructions are included.

#### 9.4 INTERNAL BOOSTER SPRING KIT

Internal spring for right side lift linkage to improve float capacity. Standard equipment on left side. Installation instructions are included.

#### 9.5 LIGHT HEADER FLOTATION KIT

Available for headers that do not require as much spring tension for float. Installation instructions are included.

#### 9.6 AM-FM RADIO

Available for installation into pre-wired cab. Speakers are factory installed.

Refer to M105 Self-Propelled Windrower Unloading and Assembly Instructions supplied with your windrower for installation details.

#### 9.7 HYDRAULIC CENTER-LINK

The hydraulic center-link allows the Operator to adjust the header angle from the cab. Installation instructions are included.

#### 9.8 FAN AIR BAFFLE KIT

Provides a baffle to reduce windrow disturbance by air exiting the engine cooling fan.

#### 9.9 TRAINING SEAT

A wall mounted fold-up training seat (complete with seat belt) is available to assist in training a new Operator. Installation instructions are included.

#### 9.10 KNIFE SPEED, REEL SPEED INDEX, AND TILT SENSOR MODULE

To allow the electronic monitoring of header knife speed, reel speed and header angle. Also enables the indexing of reel speed to ground speed. Installation instructions are included.

#### 9.11 ANTI-SHIMMY KIT FOR CASTERS

Prevents caster wheel shimmy when traveling at road speed.

#### 9.12 SWATH ROLLER

If a swath roller is desired for canola or other similar crops, an axle mounted design is recommended. Windrower can be fitted with hydraulic lift version of swath rollers featuring in console controls.

#### 9.13 WARNING BEACONS

Two roof mounted rotating warning beacons are available for installation into pre-wired cab. The beacons are standard equipment for export windrowers, and optional for North America. Installation instructions are included.

#### 9.14 AUTO-STEER

A MacDon approved auto-steer system is available for your windrower. Contact your Dealer for further information.

Cabs have been prepared with access routing knock outs to enable easy wiring harness installation and display mounting. The GSL has been pre-wired with an auto-steer engage switch.

#### 9.15 ENGINE BLOCK HEATER

Contact your nearest Cummins Engine Distributor, and provide your engine model and serial numbers to ensure the proper heater is supplied.

*(continued next page)*



## OPTIONS / ATTACHMENTS

### 9.16 TRANSPORT DRAWBAR

Allows an M105 Windrower to tow MacDon headers equipped with a Slow Speed Transport system. Includes drawbar, related parts, and installation instructions.

### 9.17 WEIGHT BOX

The weight box allows transporting the header behind the windrower by providing additional weight on the drive wheels.

### 9.18 WINDSHIELD SHADES

Retractable sun shades for front and rear windows.

### 9.19 HID AUXILLIARY LIGHTING

Provides additional field lighting. The kit includes two cab-mounted high intensity discharge lamps and installation instructions.

# INDEX

Abbreviations.....	14	Daily check.....	51
Air Cleaner .....	131	Definitions .....	14
Air Conditioning		Display Warnings .....	39
compressor belt.....	144	Draper Header	
compressor protection.....	27, 127	deck shift .....	91
compressor servicing.....	127	draper speed .....	88
condenser.....	126, 148	knife speed .....	90, 99
controls.....	26	reel speed.....	86
evaporator .....	126	Drawbar	
troubleshooting.....	187	swath roller .....	69
Alternator.....	156	Drive Wheels .....	174
Ambient Light .....	164	bolt torque .....	174
Anti-freeze.....	107	lubricant.....	175
Aspirator.....	132	removal/installation.....	176
Auger Header		Driving	
attachment.....	94	roads .....	62
auger speed.....	97	spin turn.....	59
detaching.....	101	stopping.....	59
reel speed.....	98	windrower.....	56
Auxiliary Power.....	27	Electrical System	
Ballast		circuit breakers .....	165
caster wheels.....	178	fuses.....	165
Barring Tool.....	128	main fuses.....	167
Battery.....	151	troubleshooting.....	184
adding electrolyte .....	154	Engine	
boosting .....	153	air filters.....	131
charging.....	153	alternate speeds.....	54
maintenance .....	152	battery .....	151
replacement.....	155	battery maintenance.....	152
Beacon		belt replacement.....	144
bulb replacement.....	162	belt tension .....	144
Belts		changing oil .....	130
compressor.....	144	exhaust.....	143
fan .....	144	fan belt.....	144
Bolt		fuel.....	See Fuel System
identification.....	104	inspection .....	128
Boot.....	81, 94	manually turning .....	128
Break-In		oil level .....	129
procedure .....	50	oil pressure.....	55
Cab		operating temperature .....	55
air filters.....	125, 126	operation .....	52
air vents.....	26	servicing .....	128
ingress/egress .....	57	speed adjustment.....	145
interior lighting .....	27	starting.....	52
operator amenities.....	27	throttle adjustment.....	145
radio.....	28	troubleshooting.....	181
Cab Display Module .....	32, 33	voltage.....	55
Cab Temperature .....	26	warning lights .....	38, 55
Capacities.....	107	Engine Cooling System.....	138
Caster Wheels.....	177	changing coolant .....	139
anti-shimmy .....	180	coolant level and concentration .....	138
ballast .....	178	cooling box servicing .....	148
bolt torque.....	179	radiator screen.....	146
removal/installation.....	179, 180	Engine Electrical System	
tread adjustment.....	60	damage prevention.....	156
CDM.....	32	Engine Hood .....	117
CDM Displays.....	33	Engine Lock-out	
Center Link		checks .....	120
standard.....	83	Error Codes	
Circuit Breakers.....	165	engine.....	47, 197
Compressor Oil .....	107	windrower .....	196
Console .....	20	Exhaust .....	143
Cooler.....	27	Fan Belt	

# INDEX

replacement.....	144	leaks.....	173
tension.....	144	oil changing.....	169
Fault Codes.....	47, 196	oil cooler.....	173
Field Lights.....	157	oil filters.....	169
bulb replacement.....	158	oil level.....	168
Final Drive.....	71	relief pressure.....	170
Float.....	74	traction drive.....	172
Adjustment.....	74	transmission oil pressure.....	172
Float Pin.....	81, 92, 94, 101	troubleshooting.....	184
Flood Lights		valve block.....	170
bulb replacement.....	159, 160	Ignition Switch.....	29
Fluids.....	107	Index Switch.....	86
Fuel		Interior Lights.....	164
recommended.....	107	Intermediate Speed Control (ISC).....	54
Fuel System		Jacking.....	176
filters.....	134	Knife Drive	
priming.....	137	valve block.....	170
separator.....	137	Knife Speed	
supply valve.....	136	draper header.....	99
tank venting.....	134	Levelling the Header.....	76
vent filter.....	134	Lift Cylinder Stops.....	73
Fuel Tank		Lighting	
draining.....	136	engine forward.....	24
Fueling.....	54	Lights.....	23
Fuses.....	165	headlight adjustment.....	157
Gauges.....	29	headlight bulb.....	157
Gearbox, Pump		swath.....	161
changing lubricant.....	142	Lubricants.....	107
lubricant level.....	141	Maintenance	
Greasing.....	114	platform.....	118
Ground Speed		record.....	110
control lever.....	29	Manual Storage.....	27
range switch.....	29	Metric Conversion.....	108
Hazard Warning Lights.....	29	Monitoring System.....	33
Header		Neutral Start Switch.....	124
angle adjustment.....	77	Oil Cooler.....	148
drive.....	77	Oil Filter.....	130
drop rate.....	171	Operating Screens.....	33
engage.....	77	Operation.....	58
float adjustment.....	74	Operator's Console.....	20
flotation.....	74	Operator's Presence.....	22
functions.....	32	checks.....	120
height control.....	79	engine.....	22
levelling.....	76	header drive.....	22
lift cylinder stops.....	73	transmission.....	22
monitoring.....	32	Operator's Station.....	20
on/off switch.....	30	troubleshooting.....	189
operation.....	73	Options.....	190
position switch.....	31	Owner/Operator Responsibilities.....	48
programming.....	41	Programming.....	41
return to cut.....	79	Radiator Cap.....	139
reverse.....	77	Radio.....	28
troubleshooting.....	185	Rear View Mirrors.....	25
Header Control Switches.....	30	Reel	
Header Controls.....	30	fore-aft.....	85
Heater		height switch.....	85
controls.....	26	position switch.....	31
shut-off valve.....	26	speed.....	86
Height Control.....	79	speed switch.....	31
Hub Locks.....	71	Relief Valve.....	172
Hydraulic System.....	168	Restriction Switch	
charge pump pressure.....	172	air cleaner.....	131
fitting types.....	105	Return to Cut.....	79
hoses and lines.....	173	Rotors.....	146

# INDEX

Safety		
general.....	12	
operation.....	50	
procedures.....	103	
signal words.....	7	
signs.....	7	
symbols.....	7	
Screen Rotors		
adjustment.....	147	
Seat Adjustment.....	20	
Seat Belts.....	21	
maintenance.....	120	
Serial Number.....	2	
Servicing		
preparation.....	103	
Signal Lights.....	162	
Specifications.....	15	
Starting Engine.....	52	
Steering		
links.....	123	
Steering Column Adjust.....	21	
Storage		
fuel and lubricants.....	107	
windrower.....	72	
Swath Lights.....	161	
Swath Roller.....	80	
Symbol Definitions.....	48	
Tire Inflation		
caster wheels.....	177	
drive wheels.....	174	
Torques.....	104	
Towing		
electrical.....	68	
header.....	64	
Towing Windrower.....	71	
Traction Drive		
neutral start switch.....	124	
Traction Drive System		
GSL adjustment.....	121	
hub locks.....	71	
steering links.....	123	
troubleshooting.....	185, 187	
Training Seat.....	21	
Transporting.....	62	
Troubleshooting		
air conditioning.....	187	
electrical.....	184	
engine.....	181	
header drive.....	185	
hydraulics.....	184	
operator's station.....	189	
traction drive.....	185	
Turn Signals.....	29	
Warnings		
engine.....	38	
WCM.....	33	
Welding.....	103	
Wheel Bolt Torque.....	174, 179	
Windrower		
components.....	19	
dimensions.....	17	
driving.....	56	
driving on road.....	62	
specifications.....	15	
towing.....	71	
transporting.....	62	
Windshield Wipers.....	25	



## CDM / WCM FAULT CODES

### MISC INFORMATION / ERROR CODES

E	N	G	I	N	O	I	P	R	E	S	S	U	R	E	E	Engine oil pressure warning.		
E	N	G	I	N	T	E	M	P	E	R	A	T	U	R	E		Engine coolant temperature warning.	
C	A	N	B	U	S	S	E	R	R	O	R							
K	N	I	F	E	S	P	D	O	V	E	R	L	O	A	D		Knife speed is < programmed setpoint while header engaged.	
N	O				O	P	E	R	A	T	O	R					Operator not detected in seat (~3 second delay before message)	
D	I	S	E	N	G	A	G	E	H	E	A	D	E	R			Header engage switch on when ignition turned on.	
					x	x	x	x	S		x	x	F		x	x	C	Engine code configuration (Canbus)
C	E	N	T	E	R		S	T	E	E	R	I	N	G				GSL or Pintal switches not closed with the key on / engine off.
N	O	T			I	N			P	A	R	K						GSL or Pintal switches not closed with the key on / engine off.

In the case of dual codes being shown for an item (primarily the solenoid valves) the first code indicates a SHORT CIRCUIT condition, while the second code indicates an OPEN CIRCUIT condition. E41 would be a SHORT in the reel fore / aft solenoid V2C while E141 would indicate an OPEN circuit.

## ENGINE ERROR CODES

**Example:** CDM displays the Error Code **110S 16F 28C**

STEP 1. **110S - S** is **SPN** column, then locate code **110** in that column.

STEP 2. **16F - F** is the **FMI** column, then locate code **16** in that column.

STEP 3. **28C - C** is occurrences, **28** is the quantity.

STEP 4. **DESCRIPTION** - Coolant Temperature High - Data Valid but Above Normal Operational Range - Moderately Severe Level Engine Coolant Temp.

STEP 5. Refer to **LAMP COLOR** and specific **ENGINE CODES** as required.

J1939 SPN	J1939 FMI	Lamp Color	Cummins Code	J1939 SPN Description	Description	
22	3	Amber	719	Crankcase Pressure	Extended Crankcase Blow-by Pressure Circuit - Voltage Above Normal, or Shorted to High Source	Crankcase Pressure
	4	Amber	729		Extended Crankcase Blow-by Pressure Circuit - Voltage Below Normal, or Shorted to Low Source	
52	0	Red	2114	Coolant Temperature	Coolant Temperature 2 - Data Valid but Above Normal Operational Range - Most Severe Level	Coolant Temperature
	3	Amber	2111		Coolant Temperature 2 Sensor Circuit - Voltage Above Normal, or Shorted to High Source	
	4	Amber	2112		Coolant Temperature 2 Sensor Circuit - Voltage Below Normal, or Shorted to Low Source	
	16	Amber	2113		Coolant Temperature 2 - Data Valid but Above Normal Operational Range - Moderately Severe Level	
84	2	Amber	241	Wheel Based Vehicle Speed	Vehicle Speed Sensor Circuit - Data Erratic, Intermittant or Incorrect	Wheel Based Vehicle Speed
	10	Amber	242		Vehicle Speed Sensor Circuit Tampering Has Been Detected - Abnormal Rate of Change	
91	0	Red	148	Throttle Position Sensor	Accelerator Pedal or Lever Position Sensor Circuit - Abnormal Frequency, Pulse Width, or Period	Accelerator Pedal Position
	1	Red	147		Accelerator Pedal or Lever Position Sensor Circuit - Abnormal Frequency, Pulse Width, or Period	
	2	Red	1242		Accelerator Pedal or Lever Position Sensor 1 and 2 - Data Erratic, Intermittent, or Incorrect	
	3	Red	131		Accelerator Pedal or Lever Position Sensor Circuit - Voltage Above Normal, or Shorted to High Source	
	4	Red	132		Accelerator Pedal or Lever Position Sensor Circuit - Voltage Below Normal, or Shorted to Low Source	
	8	154			Abnormal frequency, pulse width, or period	
	12	154			Bad Device or component	
19	Red	287	SAE J1939 Multiplexing Accelerator Pedal or Lever Sensor System Error - Received Network Data In Error			
93	2	Amber	528	Switch - Data	Auxiliary Alternate Torque Validation Switch - Data Erratic, Intermittant or Incorrect	Switch - Data
94	1	Amber	2216	Fuel Delivery Pressure	Fuel Pump Delivery Pressure - Data Valid but Above Normal Operational Range - Moderately Severe Level	Fuel Delivery Pressure
	2	Amber	268		Fuel Pressure Sensor Circuit - Data Erratic, Intermittent, or Incorrect	
	3	Amber	546		Fuel Pressure Sensor Circuit - Voltage Above Normal or Shorted to High Source	
	4	Amber	547		Fuel Pressure Sensor Circuit - Voltage Below Normal or Shorted to Low Source	
	15	Maint	2261		Fuel Pump Delivery Pressure - Data Valid but Above Normal Operational Range - Least Severe Level	
	17	Maint	2262		Fuel Pump Delivery Pressure - Data Valid but Below Normal Operational Range - Least Severe Level	
18	Amber	2215	Fuel Pump Delivery Pressure - Data Valid but Below Normal Operational Range - Moderately Severe Level			
95	16	Amber	2372	Engine Fuel Filter Differential Pressure	Fuel Filter Differential Pressure - Data Valid But Above Normal Operational Range - Moderately Severe Level	Engine Fuel Filter Differential Pressure
97	3	Amber	428	Water in Fuel Indicator	Water in Fuel Sensor Circuit - Voltage Above Normal, or Shorted to High Source	Water in Fuel Indicator
	4	Amber	429		Water in Fuel Sensor Circuit - Voltage Below Normal, or Shorted to Low Source	
	15	Maint	418		Water in Fuel Indicator High - Data Valid but Above Normal Operational Range - Least Severe Level	
	16	Amber	1852		Water In Fuel Indicator - Data Valid But Above Normal Operating Range - Moderately Severe Level	

*(continued next page)*

## ENGINE ERROR CODES

J1939 SPN	J1939 FMI	Lamp Color	Cummins Code	J1939 SPN Description	Description	
100	1	Red	415	Engine Oil Pressure	Oil Pressure Low - Data Valid but Below Normal Operational Range - Most Severe Level	Engine Oil Pressure
	2	Amber	435		Oil Pressure Sensor Circuit - Data Erratic, Intermittent, or Incorrect	
	3	Amber	135		Oil Pressure Sensor Circuit - Voltage Above Normal, or Shorted to High Source	
	4	Amber	141		Oil Pressure Sensor Circuit - Voltage Below Normal, or Shorted to Low Source	
	10	157			Engine oil pressure sensor 5V supply connection open circuit	
	17	N/A			Low oil pressure - WARNING	
	18	Amber	143		Oil Pressure Low – Data Valid but Below Normal Operational Range - Moderately Severe Level	
102	2	Amber	2973	Boost Pressure	Intake Manifold Pressure Sensor Circuit - Data Erratic, Intermittent, or Incorrect	Boost Pressure
	3	Amber	122		Intake Manifold Pressure Sensor Circuit - Voltage Above Normal, or Shorted to High Source	
	4	Amber	123		Intake Manifold Pressure Sensor Circuit - Voltage Below Normal, or Shorted to Low Source	
	16	Amber	124		Intake Manifold 1 Pressure - Data Valid But Above Normal Operating Range - Moderately Severe Level	
103	10	Amber	2345	Turbocharger 1 Speed	Turbocharger speed invalid rate of change detected - Abnormal Rate of Change	Turbocharger 1 Speed
	16	Amber	595		Turbocharger #1 Speed High - Data Valid but Above Normal Operational Range – Moderately Severe Level	
	18	Amber	687		Turbocharger #1 Speed Low - Data Valid but Below Normal Operational Range - Moderately Severe Level	
105	0	Red	155	Intake Manifold #1 Temp	Intake Manifold Air Temperature High - Data Valid but Above Normal Operational Range - Most Severe Level	Intake Manifold #1 Temp
	3	Amber	153		Intake Manifold Air Temperature Sensor Circuit - Voltage Above Normal, or Shorted to High Source	
	4	Amber	154		Intake Manifold Air Temperature Sensor Circuit - Voltage Below Normal, or Shorted to Low Source	
	16	Amber	488		Intake Manifold 1 Temperature - Data Valid but Above Normal Operational Range - Moderately Severe Level	
106	3	135		Inlet Manifold Pressure Sensor	Voltage above normal or shorted high	Inlet Manifold Pressure Sensor
	4	135			Voltage below normal or shorted low	
	10	135			Inlet Manifold Pressure Sensor 5V supply connection open circuit	
108	2	Amber	295	Barometric Pressure	Barometric Pressure Sensor Circuit - Data Erratic, Intermittent, or Incorrect	Barometric Pressure
	3	Amber	221		Barometric Pressure Sensor Circuit - Voltage Above Normal, or Shorted to High Source	
	4	Amber	222		Barometric Pressure Sensor Circuit - Voltage Below Normal, or Shorted to Low Source	
109	3	Amber	231	Coolant Pressure	Coolant Pressure Sensor Circuit - Voltage Above Normal, or Shorted to High Source	Coolant Pressure
	4	Amber	232		Coolant Pressure Sensor Circuit - Voltage Below Normal, or Shorted to Low Source	
	18	Amber	233		Coolant Pressure - Data Valid but Below Normal Operational Range - Moderately Severe Level	
110	0	Red	151	Engine Coolant Temperature	Coolant Temperature Low - Data Valid but Above Normal Operational Range - Most Severe Level	Engine Coolant Temperature
	2	Amber	334		Coolant Temperature Sensor Circuit - Data Erratic, Intermittent, or Incorrect	
	3	Amber	144		Coolant Temperature Sensor Circuit - Voltage Above Normal, or Shorted to High Source	
	4	Amber	145		Coolant Temperature Sensor Circuit – Voltage Below Normal, or Shorted to Low Source	
	15	None	2963		Engine Coolant Temperature High - Data Valid but Above Normal Operational Range - Least Severe Level	
	16	Amber	146		Coolant Temperature High - Data Valid but Above Normal Operational Range - Moderately Severe Level	

*(continued next page)*



## ENGINE ERROR CODES

J1939 SPN	J1939 FMI	Lamp Color	Cummins Code	J1939 SPN Description	Description	
111	1	Red	235	Coolant Level	Coolant Level Low - Data Valid But Below Normal Operating Range - Most Severe Level	Coolant Level
	2	Amber	422		Coolant Level - Data erratic, Intermittant or Incorrect	
	3	Amber	195		Coolant Level Sensor Circuit - Voltage Above Normal or Shorted to High Source	
	4	Amber	196		Coolant Level Sensor Circuit - Voltage Below Normal or Shorted to Low Source	
	18	Amber	197		Coolant Level - Data Valid But Below Normal Operating Range - Moderately Severe Level	
157	0	Red	449	Injector Metering Rail 1 Pressure	Fuel Pressure High - Data Valid but Above Normal Operational Range – Moderately Severe Level	Injector Metering Rail 1 Pressure
	0	Amber	1911		Injector Metering Rail 1 Pressure - Data Valid but Above Normal Operational Range - Most Severe Level	
	1	Amber	2249		Injector Metering Rail 1 Pressure - Data Valid but Below Normal Operational Range - Most Severe Level	
	2	Amber	554		Fuel Pressure Sensor Error - Data Erratic, Intermittent, or Incorrect	
	3	Amber	451		Injector Metering Rail #1 Pressure Sensor Circuit - Voltage Above Normal, or Shorted to High Source	
	4	N/A			Voltage below normal or shorted low	
	4	Amber	452		Injector Metering Rail #1 Pressure Sensor Circuit - Voltage Below Normal, or Shorted to Low Source	
	16	Amber	553		Injector Metering Rail #1 Pressure High – Data Valid but Above Normal Operational Range - Moderately Severe Level	
	18	Amber	559		Injector Metering Rail #1 Pressure Low – Data Valid but Below Normal Operational Range - Moderately Severe Level	
158	2	439		Keyswitch	Data erratic, intermittent, or incorrect	Keyswitch
166	2	None	951	Cylinder Power	Cylinder Power Imbalance Between Cylinders - Data Erratic, Intermittent, or Incorrect	Cylinder Power
167	1	Red	598	Alternate Potential (voltage)	Electrical Charging System Voltage Low – Data Valid but Below Normal Operational Range - Most Severe Level	Alternator Potential (voltage)
	16	Amber	596		Electrical Charging System Voltage High – Data Valid but Above Normal Operational Range - Moderately Severe Level	
	18	Amber	597		Electrical Charging System Voltage Low – Data Valid but Below Normal Operational Range - Moderately Severe Level	
168	0	422		ECM battery power	Excessive battery power	ECM battery power
	1				Low battery power	
	2				Intermittent	
	16	Amber	442		Battery #1 Voltage High - Data Valid but Above Normal Operational Range – Moderately Severe Level	
	18	Amber	441		Battery #1 Voltage Low - Data Valid but Below Normal Operational Range – Moderately Severe Level	
171	3	Amber	249	Ambient Air Temperature	Ambient Air Temperature Sensor Circuit - Voltage Above Normal, or Shorted to High Source	Ambient Air Temperature
	4	Amber	256		Ambient Air Temperature Sensor Circuit - Voltage Below Normal, or Shorted to Low Source	
174	3	Amber	263	Fuel Temperature	Engine Fuel Temperature Sensor 1 Circuit - Voltage Above Normal, or Shorted to High Source	Fuel Temperature
	4	Amber	265		Engine Fuel Temperature Sensor 1 Circuit - Voltage Below Normal, or Shorted to Low Source	
	16	Amber	261		Engine Fuel Temperature - Data Valid but Above Normal Operational Range - Moderately Severe Level	
175	0	Red	214	Oil Temperature	Engine Oil Temperature - Data Valid but Above Normal Operational Range - Most Severe Level	Oil Temperature
	2	Amber	425		Engine Oil Temperature -Data Erratic, Intermittent, or Incorrect	
	3	Amber	212		Engine Oil Temperature Sensor 1 Circuit - Voltage Above Normal, or Shorted to High Source	
	4	Amber	213		Engine Oil Temperature Sensor 1 Circuit - Voltage Below Normal, or Shorted to Low Source	
190	0	Red	234	Engine Speed	Engine Speed High - Data Valid but Above Normal Operational Range - Most Severe Level	Engine Speed
	2	Amber	689		Primary Engine Speed Sensor Error – Data Erratic, Intermittent, or Incorrect	
	2	None	2321		Engine Speed / Position Sensor #1 - Data Erratic, Intermittent, or Incorrect	
	8	141			Abnormal signal frequency	
	15	N/A			Engine Overspeed - WARNING	

*(continued next page)*

## ENGINE ERROR CODES

J1939 SPN	J1939 FMI	Lamp Color	Cummins Code	J1939 SPN Description	Description	
191	16	Amber		Transmission Output Shaft Speed	Transmission Output Shaft Speed - Data Valid but Above Normal Operating Range - Moderately Severe Level	Transmission Output Shaft Speed
	18	Amber			Transmission Output Shaft Speed - Data Valid but Below Normal Operating Range - Moderately Severe Level	
251	2	Maint	319	Real Time Clock Power	Real Time Clock Power Interrupt - Data Erratic, Intermittent, or Incorrect	Real Time Clock Power
412	3	Amber	2375	Exhaust Gas Recirculation Temperature	Exhaust Gas Pressure Sensor Circuit - Voltage Above Normal or Shorted to High Source	Exhaust Gas Recirculation Temperature
	4	Amber	2376		Exhaust Gas Pressure Sensor Circuit - Voltage Below Normal or Shorted to Low Source	
441	3	Amber	293	OEM Temperature	Auxiliary Temperature Sensor #1 Circuit - Voltage Above Normal or Shorted to High Source	OEM Temperature
	4	Amber	294		Auxiliary Temperature Sensor #1 Circuit - Voltage Below Normal or Shorted to Low Source	
	14	Red	292		Auxiliary Temperature Sensor Input #1 - Special Instructions	
558	2	Amber	431	Accelerator Pedal Low Idle Switch	Accelerator Pedal or Lever Idle Validation Circuit - Data Erratic, Intermittent, or Incorrect	Accelerator Pedal Low Idle Switch
	2	155			Data erratic, intermittent, or incorrect	
	4	Amber	551		Accelerator Pedal or Lever Idle Validation Circuit - Voltage Below Normal, or Shorted to Low Source	
	13	Red	432		Accelerator Pedal or Lever Idle Validation Circuit - Out of Calibration	
611	2	Amber	523	System Diagnostic code # 1	OEM Intermediate (PTO) Speed switch Validation -Data Erratic, Intermittent, or Incorrect	System Diagnostic code # 1
	16	Amber	2292	Fuel Inlet Meter Device	Fuel Inlet Meter Device - Data Valid but Above Normal Operational Range - Moderately Severe Level	
	18	Amber	2293	Fuel Inlet Meter Device	Fuel Inlet Meter Device flow demand lower than expected - Data Valid but Below Normal Operational Range - Moderately Severe Level	
612	2	Red	115	System Diagnostic Code # 2	Engine Speed / Position Sensor Circuit lost both of two signals from the magnetic pickup sensor - Data Erratic, Intermittent, or incorrect	System Diagnostic Code # 2
623	4	Amber	244	Red Stop Lamp	Red Stop Lamp Driver Circuit - Voltage Below Normal or Shorted to Low Source	Red Stop Lamp
627	2	None	1117	Power Supply	Power Lost With Ignition On - Data Erratic, Intermittent, or Incorrect	Power Supply
	12	Amber	351		Injector Power Supply - Bad Intelligent Device or Component	
629	12	Red	111	Controller #1	Engine Control Module Critical internal failure - Bad intelligent Device or Component	Controller #1
	12	Amber	343		Engine Control Module Warning internal hardware failure - Bad Intelligent Device or Component	
	12	Amber	351		Injector Power Supply - Bad Intelligent Device or Component	
630	2	Amber	341	Calibration Memory	Engine Control Module data lost - Data Erratic, Intermittent, or Incorrect	Calibration Memory
	13	Red	342		Electronic Calibration Code Incompatibility - Out of Calibration	
	31	Amber	2217		ECM Program Memory (RAM) Corruption - Condition Exists	
631	2	415		Engine software	Data incorrect	Engine software
633	31	Amber	2311	Fuel Control Valve #1	Fueling Actuator #1 Circuit Error - Condition Exists	Fuel Control Valve #1
637	11	143		Primary to secondary speed signal	Calibration fault	Primary to secondary speed signal
639	9	Amber	285	SAE J1939 Datalink	SAE J1939 Multiplexing PGN Timeout Error - Abnormal Update Rate	SAE J1939 Datalink
	13	Amber	286		SAE J1939 Multiplexing Configuration Error - Out of Calibration	
640	14	Red	599	Engine External Protection Input	Auxiliary Commanded Dual Output Shutdown - Special Instructions	Engine External Protection Input
644	2	Amber		External Speed Input	External Speed Input (Multiple Unit Synchronization) - Data Erratic, Intermittent or Incorrect	External Speed Input
646	5	177		Turbo Wastegate	Solenoid Current Low	Turbo Wastegate
	6	177			Solenoid Current High	
647	3	Amber	2377	Fan Clutch Output Device Driver	Fan Control Circuit - Voltage Above Normal or Shorted to High Source	Fan Clutch Output Device Driver
	4	Amber			Fan Control Circuit - Voltage Below Normal or Shorted to Low Source	

*(continued next page)*

## ENGINE ERROR CODES

J1939 SPN	J1939 FMI	Lamp Color	Cummins Code	J1939 SPN Description	Description	
651	5	Amber	322	Injector Cylinder #01	Injector Solenoid Cylinder #1 Circuit - Current Below Normal, or Open Circuit	Injector Cylinder #01
	6	N/A			Injector Current High	
	7	Amber	1139		Injector Cylinder #1 - Mechanical System Not Responding Properly or Out of Adjustment	
652	5	Amber	331	Injector Cylinder #02	Injector Solenoid Cylinder #2 Circuit - Current Below Normal, or Open Circuit	Injector Cylinder #02
	6	N/A			Injector Current High	
	7	Amber	1141		Injector Cylinder #2 - Mechanical System Not Responding Properly or Out of Adjustment	
653	5	Amber	324	Injector Cylinder #03	Injector Solenoid Cylinder #3 Circuit - Current Below Normal, or Open Circuit	Injector Cylinder #03
	6	N/A			Injector Current High	
	7	Amber	1142		Injector Cylinder #3 - Mechanical System Not Responding Properly or Out of Adjustment	
654	5	Amber	332	Injector Cylinder #04	Injector Solenoid Cylinder #4 Circuit - Current Below Normal, or Open Circuit	Injector Cylinder #04
	6	N/A			Injector Current High	
	7	Amber	1143		Injector Cylinder #4 - Mechanical System Not Responding Properly or Out of Adjustment	
655	5	Amber	323	Injector Cylinder #05	Injector Solenoid Cylinder #5 Circuit - Current Below Normal, or Open Circuit	Injector Cylinder #05
	6	N/A			Injector Current High	
	7	Amber	1144		Injector Cylinder #5 - Mechanical System Not Responding Properly or Out of Adjustment	
656	5	Amber	325	Injector Cylinder #06	Injector Solenoid Cylinder #6 Circuit - Current Below Normal, or Open Circuit	Injector Cylinder #06
	6	N/A			Injector Current High	
	7	Amber	1145		Injector Cylinder #6 - Mechanical System Not Responding Properly or Out of Adjustment	
676	5	199		Glow Plug Start Aid relay	Current Low	Glow Plug Start Aid relay
	6	199			Current High	
677	3	Amber	584	Starter Solenoid Lockout Relay Driver Circuit	Starter Relay Circuit - Voltage Above Normal, or Shorted to High Source	Starter Solenoid Lockout Relay Driver Circuit
	4	Amber	585		Starter Relay Circuit - Voltage Below Normal, or Shorted to Low Source	
678	3	517		8V DC supply	ECM 8V DC supply - voltage above normal or shorted high	8V DC supply
	4	517			ECM 8V DC supply - voltage below normal or shorted low	
697	3	Amber		Auxiliary PWM Driver #1	Auxiliary PWM Driver #1 - Voltage Above Normal or Shorted to High Source	Auxiliary PWM Driver #1
	4	Amber			Auxiliary PWM Driver #1 - Voltage Below Normal or Shorted to Low Source	
702	3	Amber		Circuit - Voltage	Auxiliary Input / Output 2 Circuit - Voltage Above Normal or Shorted to High Source	Circuit - Voltage
703	3	Amber	529	Auxiliary Equipment Sensor Input	Auxiliary Input / Output 3 Circuit - Voltage Above Normal or Shorted to High Source	Auxiliary Equipment Sensor Input
	11	Amber	779		Warning Auxiliary Equipment Sensor Input #3 (OEM Switch) - Root Cause Not Known	
	14	Amber	2195		Auxiliary Equipment Sensor Input #3 (OEM Switch) - Engine Protection Critical - Special Instructions	
723	2	Amber	778	Engine Speed Sensor #2	Engine Speed Sensor (Camshaft) Erratic, Intermittent, or Incorrect	Engine Speed Sensor #2
	2	None	2322		Engine Speed / Position Sensor #2 - Data Erratic, Intermittent, or Incorrect	
	7	Amber	731		Engine Speed/Position #2 mechanical misalignment between camshaft and crankshaft sensors - Mechanical System Not Responding Properly or Out of Adjustment	
	8	142			Abnormal signal frequency	
729	3	Amber	2555	Intake Air Heater Driver #1	Intake Air heater #1 Circuit - Voltage Above Normal or Shorted to High Source	Intake Air heater Driver #1
	4	Amber	2556		Intake Air heater #1 Circuit - Voltage Below Normal or Shorted to Low Source	
730	3		2426	Intake Air Heater #2	Intake Air heater #2 Circuit - Voltage Above Normal or Shorted to High Source	Intake Air Heater #2
	4		2425		Intake Air heater #2 Circuit - Voltage Below Normal or Shorted to Low Source	
974	3	Red	133	Remote Accelerator	Remote Accelerator Pedal or Lever Position Sensor Circuit - Voltage Above Normal or Shorted to High Source	Remote Accelerator
	4	Red	134		Remote Accelerator Pedal or Lever Position Sensor Circuit - Voltage Below Normal or Shorted to Low Source	
	19	Red	288		SAE J1939 Multiplexing Accelerator Pedal or Lever Sensor System Error - Received Network Data In Error	

(continued next page)

## ENGINE ERROR CODES

J1939 SPN	J1939 FMI	Lamp Color	Cummins Code	J1939 SPN Description	Description	
1043	4	Amber	284	Internal Sensor Voltage Supply	Engine Speed/Position Sensor (Crankshaft) Supply Voltage Circuit - Voltage Below Normal, or Shorted to Low Source	Internal Sensor Voltage Supply
1072	3	Amber	2182	Engine Brake Output #1	Engine Brake Actuator Driver 1 Circuit - Voltage Above Normal or Shorted to High Source	Engine Brake Output #1
	4	Amber	2183		Engine Brake Actuator Driver 1 Circuit - Voltage Below Normal or Shorted to Low Source	
1073	3	Amber	2367	Engine Compression Brake #2	Engine Brake Actuator Driver 2 Circuit - Voltage Above Normal or Shorted to High Source	Engine Compression Brake #2
	4	Amber	2363		Engine Brake Actuator Driver 2 Circuit - Voltage Below Normal or Shorted to Low Source	
1075	3	Amber	2265	Electric Lift Pump for Engine Fuel	Fuel Priming Pump Control Signal Circuit - Voltage Above Normal, or Shorted to High Source	Electric Lift Pump for Engine Fuel
	4	Amber	2266		Fuel Priming Pump Control Signal Circuit - Voltage Below Normal, or Shorted to Low Source	
1112	3	Amber	2368	Engine Brake Output #3	Engine Brake Actuator Driver 3 Circuit - Voltage Above Normal or Shorted to High Source	Engine Brake Output #3
	4	Amber	2365		Engine Brake Actuator Driver 3 Circuit - Voltage Below Normal or Shorted to Low Source	
1136	3	Amber	697	Sensor Circuit - Voltage	ECM Internal Temperature Sensor Circuit - Voltage Above Normal, or Shorted to High Source	Sensor Circuit - Voltage
	4	Amber	698		ECM Internal Temperature Sensor Circuit - Voltage Below Normal, or Shorted to Low Source	
1172	3	Amber	691	Turbocharger #1 Compressor Inlet Temperature	Turbocharger #1 Compressor Inlet Temperature Sensor Circuit - Voltage Above Normal, or Shorted to High Source	Turbocharger #1 Compressor Inlet Temperature
	4	Amber	692		Turbocharger #1 Compressor Inlet Temperature Sensor Circuit - Voltage Below Normal, or Shorted to Low Source	
1188	7	177		Turbo Wastegate	Turbo Wastegate not responding	Turbo Wastegate
1209	3	Amber	2373	Exhaust Gas Pressure	Exhaust Gas Pressure Sensor - Voltage Above Normal or Shorted to High Source	Exhaust Gas Pressure
	4	Amber	2374		Exhaust Gas Pressure Sensor - Voltage Below Normal or Shorted to Low Source	
1267	3	338		Vehicle Accessories Relay Driver	Idle Shutdown Vehicle Accessories Relay Driver Circuit - Voltage Above Normal or Shorted to High Source	Vehicle Accessories Relay Driver
	4	339			Idle Shutdown Vehicle Accessories Relay Driver Circuit - Voltage Below Normal or Shorted to Low Source	
1347	3	Amber	272	Fuel Pump Pressurizing Assembly #1	High Fuel Pressure Solenoid Valve Circuit - Voltage Above Normal, or Shorted to High Source	Fuel Rail Pump
	4	Amber	271		High Fuel Pressure Solenoid Valve Circuit - Voltage Below Normal, or Shorted to Low Source	
	5	162			Output current low	
	6	162			Output current high	
	7	Amber	281		High Fuel Pressure Solenoid Valve #1 - Mechanical System Not Responding Properly or Out of Adjustment	
1377	2	Amber	497	Switch Circuit	Multiple Unit Synchronization Switch Circuit - Data Erratic, Intermittant or Incorrect	Switch Circuit
1378	31	Maint	649	Engine Oil Change Interval	Change Lubricating Oil and Filter - Condition Exists	Engine Oil Change Interval
1388	3	Amber	297	Auxiliary Pressure	Auxiliary Pressure Sensor Input # 2 Circuit - Voltage Above Normal, or Shorted to High Source	Auxiliary Pressure
	4	Amber	298		Auxiliary Pressure Sensor Input # 2 Circuit - Voltage Below Normal, or Shorted to Low Source	
	14	Red	296		Auxiliary Pressure Sensor Input 1 - Special Instructions	
1484	31	None	211	J1939 Error	Additional Auxiliary Diagnostic Codes logged - Condition Exists	J1939 Error
1563	2	Amber	1256	Control Module Identification Input State	Control Module Identification Input State Error - Data Erratic, Intermittent, or Incorrect	Control Module Identification Input State
	2	Red	1257		Control Module Identification Input State Error - Data Erratic, Intermittent, or Incorrect	
1661	4	Amber	199	Engine Automatic Start Lamp	Engine Automatic Start Lamp Driver Circuit - Voltage Above Normal or Shorted to High Source	Engine Automatic Start Lamp
1800	16	Amber	2263	Battery Temperature	Battery Temperature - Data Valid but Above Normal Operational Range - Moderately Severe Level	Battery Temperature
	18	Amber	2264		Battery Temperature - Data Valid but Below Normal Operational Range - Moderately Severe Level	

(continued next page)

## ENGINE ERROR CODES

J1939 SPN	J1939 FMI	Lamp Color	Cummins Code	J1939 SPN Description	Description	
2623	3	Amber	1239	Accelerator Pedal Position	Accelerator Pedal or Lever Position Sensor 2 Circuit - Voltage Above Normal, or Shorted to High Source	Accelerator Pedal Position
	4	Amber	1241		Accelerator Pedal or Lever Position Sensor 2 Circuit - Voltage Below Normal, or Shorted to Low Source	
2789	15	None	2346	System Diagnostic Code #1	Turbocharger Turbine Inlet Temperature (Calculated) - Data Valid but Above Normal Operational Range - Least Severe Level	System Diagnostic Code #1
2790	15	None	2347		Turbocharger Compressor Outlet Temperature (Calculated) - Data Valid but Above Normal Operational Range - Least Severe Level	
2802	31	Amber	757	Electronic Control Module	Electronic Control Module data lost - Condition Exists	ECM Data Lost
2981	3	Amber	2115	Coolant Pressure	Coolant Pressure 2 Circuit - Voltage Above Normal, or Shorted to High Source	Coolant Pressure
	4	Amber	2116		Coolant Pressure 2 Circuit - Voltage Below Normal, or Shorted to Low Source	
	18	Amber	2117		Coolant Pressure 2 - Data Valid but Below Normal Operational Range - Moderately Severe Level	
3509	3	Amber	386	5 Volts DC Supply	Sensor Supply Voltage #1 Circuit - Voltage Above Normal, or Shorted to High Source	5 Volt Supply DC
	4	Amber	352		Sensor Supply Voltage #1 Circuit - Voltage Below Normal, or Shorted to Low Source	
3510	3	Amber	227	5 Volts DC Supply	Sensor Supply Voltage #2 Circuit - Voltage Above Normal, or Shorted to High Source	5 Volt Supply DC
	4	Amber	187		Sensor Supply Voltage #2 Circuit - Voltage Below Normal, or Shorted to Low Source	
3511	3	Amber	239	System Diagnostic code # 1	Sensor Supply Voltage #3 Circuit - Voltage Above Normal, or Shorted to High Source	System Diagnostic code # 1
3511	4	Amber	238		Sensor Supply Voltage #3 Circuit - Voltage Below Normal, or Shorted to Low Source	
3512	3	Amber	2185	System Diagnostic code # 1	Sensor Supply Voltage #4 Circuit - Voltage Above Normal, or Shorted to High Source	System Diagnostic code # 1
	4	Amber	2186		Sensor Supply Voltage #4 Circuit - Voltage Below Normal, or Shorted to Low Source	
520199	3	Amber	193	Cruise Control	Cruise Control (Resistive) signal Circuit - Voltage Above Normal or Shorted to High	Cruise Control
	4	Amber	194		Cruise Control (Resistive) signal Circuit - Voltage Above Normal or Shorted to High	

**END**

## NOTES

**MacDon Industries Ltd.**

680 Moray Street  
Winnipeg, Manitoba  
Canada R3J 3S3  
t. (204) 885-5590  
f. (204) 832-7749

**MacDon, Inc.**

10708 N. Pomona Avenue  
Kansas City, Missouri  
United States 64153-1924  
t. (816) 891-7313  
f. (816) 891-7323

**MacDon Australia Pty. Ltd.**

A.C.N. 079 393 721  
P.O. Box 243, Suite 3, 143 Main Street  
Greensborough, Victoria, Australia 3088  
t. 03 9432 9982  
f. 03 9432 9972

**LLC MacDon Russia Ltd.**

123317 Moscow, Russia  
10 Presnenskaya nab, Block C  
Floor 5, Office No. 534, Regus Business Centre  
t. +7 495 775 6971  
f. +7 495 967 7600

**CUSTOMERS**  
**[www.macdon.com](http://www.macdon.com)**

**DEALERS**  
**[www.macdondealers.com](http://www.macdondealers.com)**

Trademarks of products are the marks of their  
respective manufacturers and/or distributors.

Printed in Canada