

MacDon

Model 9200 / 9300 SELF-PROPELLED WINDROWER

OPERATOR'S MANUAL

MacDon Industries Ltd.

680 Moray Street
Winnipeg, Manitoba R3J 3S3
(204) 885-5590, Fax 832-7749



MacDon, Inc.

9700 N.W. Conant Avenue
Kansas City, Missouri 64153-1832
(816) 891-7313, Fax 891-7323

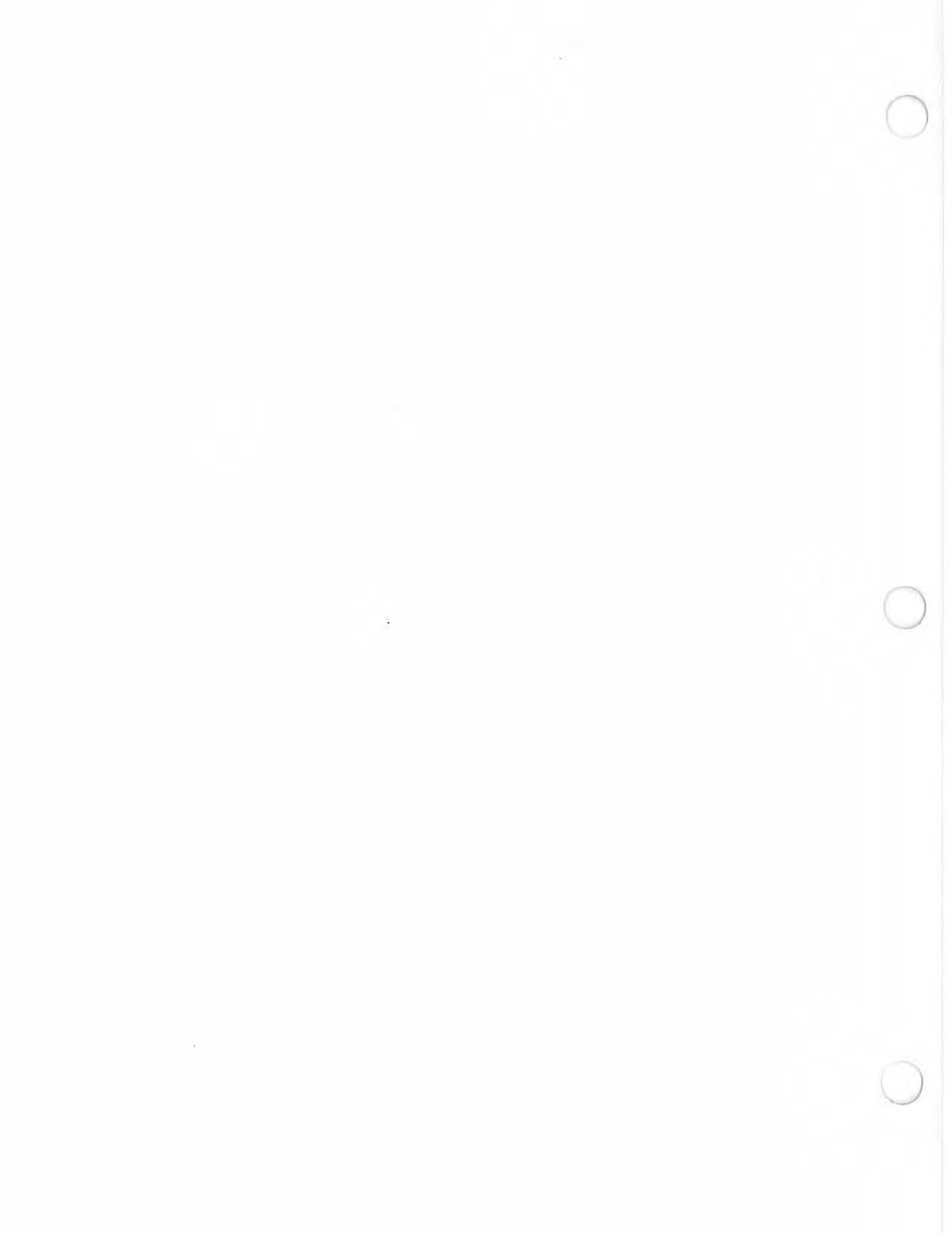

INTRODUCTION

Your new Self-Propelled Windrower is designed to cut and lay in windrows, a wide variety of grain, hay and specialty crops. Windrowing allows starting the harvest earlier, protects the crop from wind damage, and gives you more flexibility in scheduling combine time.

The power unit (referred to in this manual as the "tractor"), when coupled with one of the specially designed draper or auger headers, provides a package which incorporates many features and improvements in design requested by Owner/Operators like yourself.

NOTE: This manual contains information on the windrower tractor only. It is to be used in conjunction with the Header Operator's Manual.

CAREFULLY READ BOTH MANUALS TO BECOME FAMILIAR WITH ALL RECOMMENDED PROCEDURES BEFORE ATTEMPTING TO UNLOAD, ASSEMBLE OR USE THE WINDROWER.

Use the manual as your first source of information about the machine. If you follow the instructions given in this manual, your Windrower will work well for many years.

The manual contains instructions for "Safety", "Operation", and "Maintenance/Service". In addition "Unloading and Assembly" information is given towards the back of this book.

Use the Table of Contents and the Index to guide you to specific areas. Study the Table of Contents to familiarize yourself with how the material is organized.

Keep this manual handy for frequent reference and to pass on to new operators or owners. Call your Windrower dealer if you need assistance, information, or additional copies of the manuals.

NOTE: Right hand (R/H) and left hand (L/H) designations are determined from the operator's position, facing forward.

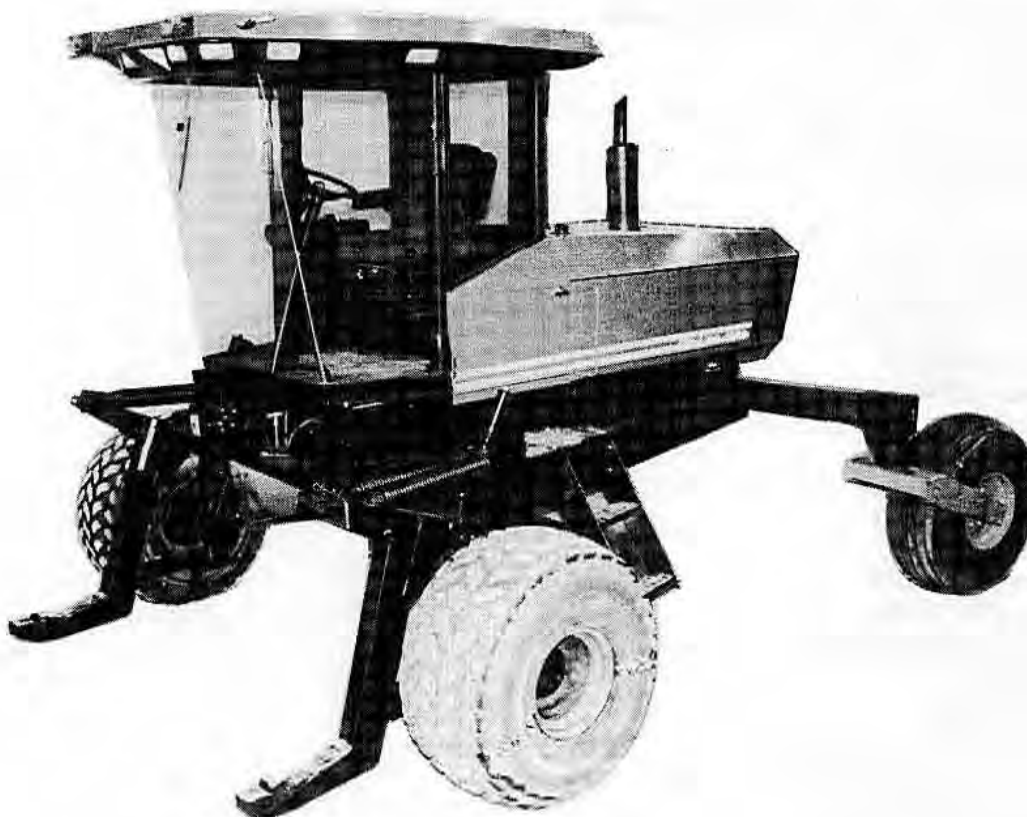

TABLE OF CONTENTS

	PAGE
INTRODUCTION	1
SERIAL NUMBER LOCATIONS	5
SAFETY	
Safety Alert Symbol	6
Signal Words	6
Safety Signs	7,8
General Farm Safety	9,10
SPECIFICATIONS	
Tractor	11
Engines	12
Hardware Torque Specifications	13
Hydraulic Fitting Torque Specifications	14
OPERATOR'S STATION	
Symbol Definitions	15,16
Machine Monitors	17
Ignition Switch	18
Lights	18
Cab Temperature Controls	19
Windshield Wiper Control	19
Windrower Controls	20
Header Controls	21,22
Seat	23
OPERATION	
Your Responsibilities as an Owner/Operator	24
To the New Operator	24
Break-In Period	25
Pre-Starting Checks: Annual	26
Pre-Starting Checks: Daily	27
Start-Up Procedure	28,29
Driving the Windrower	
Safety	30
To Drive Forward	31
To Drive Rearward	32
Making a Spin Turn	33
Stopping Procedure	
To Stop Windrower	34
To Stop Engine	34
Leaving the Windrower	35
Emergency Exit	35
Attaching the Header	36-39
Adding Rear Weight	39
Detaching the Header	40,41
Operating the Header	42
Header Lift Cylinder Stops	42
Header Angle	43
Header Levelling	44
Header Flotation	45
Transporting the Windrower	
Driving on Roads	46
Towing With a Trailer	47,48
Towing without a Trailer	49,50
Storage Procedure	51

TABLE OF CONTENTS

	PAGE
MAINTENANCE/SERVICE	
Service Procedures	52
Fuels, Fluids and Lubricants	
Diesel Fuel	53
Engine Coolant	53
Grease	53
Hydraulic Oil	54
Engine Oil	54
Bevel Gear Box Lubricant	54
Power Wheel Gear Lubricant	54
Storing Lubricants	54
System Capacities	55
Greasing the Windrower Tractor	55,56
Engine: Opening Left and Right Side Panels	57
Diesel Engine	
Lubricating Oil	58,59
Belts	59
Engine Speed: Throttle Rod Adjustment	60
Valve Tappet Clearance	61
General Engine Inspection	61
Diesel Engine Air Intake System: Air Cleaner	62,63
Diesel Engine Fuel System	
Storing Fuel	64
Refuelling Windrower	64
Fuel Tank Venting	64
Fuel Sediment Bowl	65
Fuel Water Separator	65
Fuel Filters	66
Fuel System Air Removal	67,68
Engine Exhaust System: Muffler	69
Engine Cooling System	
Coolant Level	70
Radiator Cap	70
Anti-Freeze Concentration	70
Changing Coolant	71
Screens and Coolers	72
Electrical System	
Battery	73-75
Preventing Alternator and Regulator Damage	76
Lamps and Bulbs	77,78
Circuit Breakers	79
Electrical Schematics	80-83
Hydraulic System	
Safety	84
Hydraulic Oil Cooler	84
Hydraulic Oil & Filters	84,85

TABLE OF CONTENTS

	PAGE
MAINTENANCE/SERVICE (continued)	
Hydraulic System: Header & Reel Lift	
Cylinder Control Valve Relief Pressure	86
Header & Reel Lift Hydraulic Schematic	87
Header Drive: Hydraulics	
Flow Control Block	88
Header Drive Relief Pressure	88
Header Drive Hydraulic Schematic	89
Header Drive	
Bevel Gear Box Lubricant	90
Header Drive Belt	90
Header Drive Belt Pulley Alignment	91,92
Header Drive Belt Guides & Pulley Shield	92,93
Traction Drive: Hydraulics	
Transmission Oil Pressure	94
Charge Pump Pressure	94
Traction Drive Hydraulic Schematic	95
Traction Drive: Neutral Lock and Steering	
Checks	96-98
Troubleshooting	99
Neutral Set-Up Procedure	100,101
Traction Drive:	
Ground Speed Lever Friction Device	102
Two Speed Linkage	103,104
Wheels and Tires	105,106
Park Brake	107
Cab Air System	108-110
MAINTENANCE SCHEDULE	111-112
MAINTENANCE RECORD	113
TROUBLE SHOOTING	
Cab Air System	114-117
Engine	117-122
Electrical	122,123
Traction Drive System	123-125
Steering and Ground Speed Controls	125
Header Hydraulics	126
Header Drive	126-128
Park Brake	128
Operator's Seat	128
OPTIONS AND ATTACHMENTS	129
UNLOADING	130,131
ASSEMBLY	
Tires	132, 133
Battery	134,135
Adjustments & Checks	135
Preparing for Harvest Headers	136-139
Radio & Two-Way Radio Installation	140,141
Swath Roller Installation	141
INDEX	142-144

SERIAL NUMBER LOCATIONS

Record the serial numbers in the space provided.

Tractor: _____

Plate is located on left side of main frame, near rear corner.

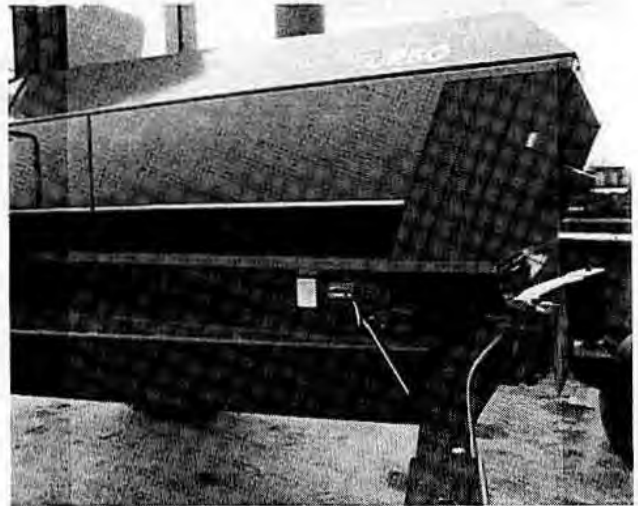

TRACTOR SERIAL PLATE LOCATION

Diesel Engine: _____

Plate is located on right side of block, beside injection pump.

NOTE: When ordering parts and service, be sure to give your dealer the complete and proper serial number. For engine parts, see your local Cummins engine dealer.

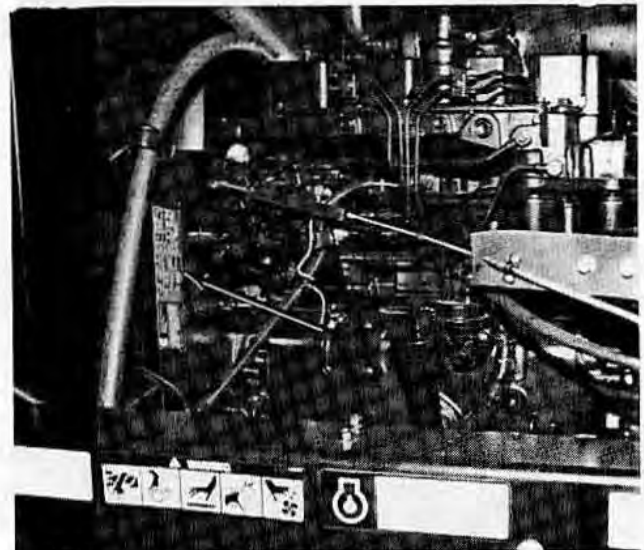

DIESEL ENGINE SERIAL PLATE LOCATION

SAFETY

SAFETY ALERT SYMBOL



This safety alert symbol identifies important safety messages in this manual and on safety signs on the Windrower.

This symbol means: **ATTENTION!**
 BECOME ALERT!
 YOUR SAFETY IS INVOLVED!

Carefully read and follow the safety message accompanying this symbol.

Why is SAFETY important to you?

3 BIG REASONS

- ACCIDENTS DISABLE AND KILL
- ACCIDENTS COST
- ACCIDENTS CAN BE AVOIDED

SIGNAL WORDS

Note the use of the signal words DANGER, WARNING and CAUTION with safety messages. The appropriate signal word for each message has been selected using the following guidelines:



- an immediate and specific hazard or forbidden practice which **WILL** result in severe personal injury or death if the message is not followed.



- a specific hazard or unsafe practice which **COULD** result in severe personal injury or death if the message is not followed.



- unsafe practice which could result in personal injury if the message is not followed, or a reminder of good safety practices.

SAFETY

SAFETY SIGNS

- The safety signs reproduced below appear on the windrower at the locations listed.
- Keep safety signs clear and legible at all times.
- Replace safety signs that are missing or become illegible.
- If original parts on which a safety sign was installed are replaced, be sure the repair part also bears the current safety sign.
- Safety signs are available from your Dealer Parts Department. The part number is printed in the lower R/H corner of each safety sign.

To install safety signs:

1. Be sure the installation area is clean and dry.
2. Decide on the exact position before you remove the backing paper.
3. Remove the smaller portion of the split backing paper.
4. Place the sign in position and slowly peel back the remaining paper, smoothing the sign as it is applied.
5. Small air pockets can be smoothed out or pricked with a pin.



CENTER FRAME CROSS CHANNEL
(BOTH SIDES)



LIFT LEGS

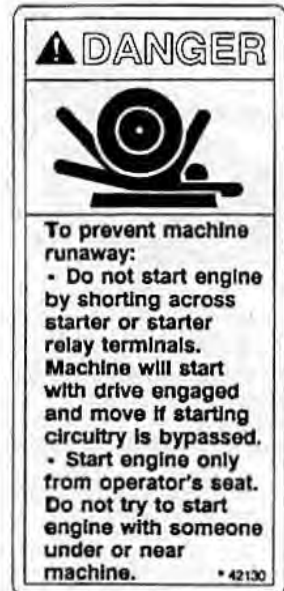

FRONT LEFT
ENGINE SUPPORT



DRIVELINE



ENGINE COMPARTMENT, LEFT REAR

SAFETY

SAFETY SIGNS (continued)



ENGINE COMPARTMENT, RIGHT REAR



— HEADER DRIVE PULLEY SHIELD



REAR FRAME
CROSS CHANNEL



CAB DOOR &
LEFT CAB CENTER POST



ENGINE COMPARTMENT -
LEFT & RIGHT

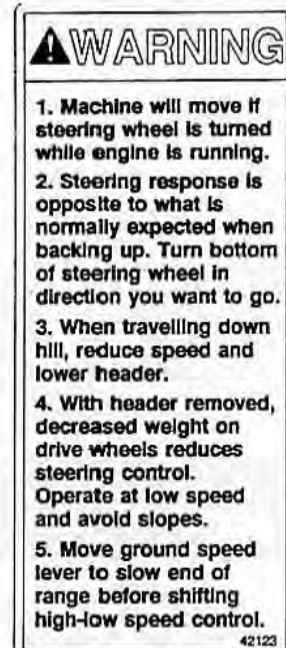

LEFT CAB CENTER POST

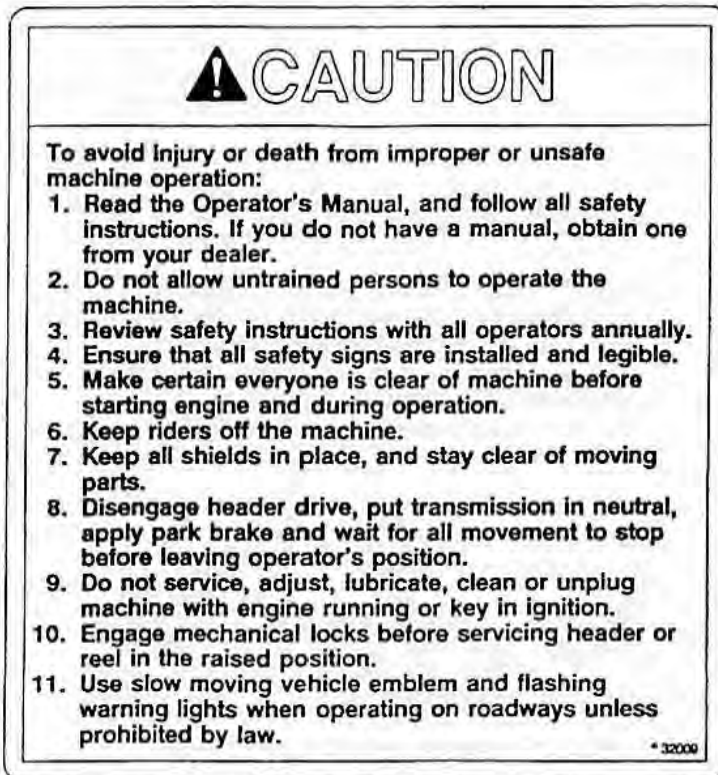

CAB DOOR, SIDE PANEL



DRIVELINE
FAN SHIELD



RADIATOR MOUNT, LEFT SIDE

SAFETY

GENERAL SAFETY



The following are general farm safety precautions that should be part of your operating procedure for all types of machinery.

1. Protect yourself.

When assembling, operating and servicing machinery, wear all the protective clothing and personal safety devices that **COULD** be necessary for the job at hand. Don't take chances.

You may need:

- a hard hat.
- protective shoes with slip resistant soles.
- protective glasses or goggles.
- heavy gloves.
- wet weather gear.
- respirator or filter mask.
- hearing protection. Be aware that prolonged exposure to loud noise can cause impairment or loss of hearing. Wearing a suitable hearing protective device such as ear muffs (A) or ear plugs (B) protects against objectionable or loud noises.



PROTECT YOURSELF



PROTECT AGAINST NOISE

2. Provide a first-aid kit for use in case of emergencies.
3. Keep a fire extinguisher on the machine. Be sure the extinguisher is properly maintained and be familiar with its proper use.
4. Keep young children away from machinery at all times.
5. Be aware that accidents often happen when the operator is tired or in a hurry to get finished. Take the time to consider the safest way. Never ignore warning signs of fatigue.



BE PREPARED FOR EMERGENCIES

SAFETY



GENERAL SAFETY (continued)

6. Wear close-fitting clothing and cover long hair. Never wear dangling items such as scarves or bracelets.
7. Keep hands, feet, clothing and hair away from moving parts. Never attempt to clear obstructions or objects from a machine while the engine is running.
8. Keep all shields in place. Never alter or remove safety equipment. Make sure driveline guards can rotate independently of the shaft and can telescope freely.
9. Use only service and repair parts made or approved by the equipment manufacturer. Substituted parts may not meet strength, design, or safety requirements.
10. Do not modify the machine. Unauthorized modifications may impair the function and/or safety and affect machine life.
11. Stop engine and remove key from ignition before leaving operator's seat for any reason. A child or even a pet could engage an idling machine.
12. Keep the area used for servicing machinery clean and dry. Wet or oily floors are slippery. Wet spots can be dangerous when working with electrical equipment. Be sure all electrical outlets and tools are properly grounded.
13. Use adequate light for the job at hand.
14. Keep machinery clean. Straw and chaff on a hot engine are a fire hazard. Do not allow oil or grease to accumulate on service platforms, ladders or controls. Clean machines before storage.
15. Never use gasoline, naphtha or any volatile material for cleaning purposes. These materials may be toxic and/or flammable.
16. When storing machinery, cover sharp or extending components to prevent injury from accidental contact.



NEVER WEAR LOOSE
OR DANGLING CLOTHES

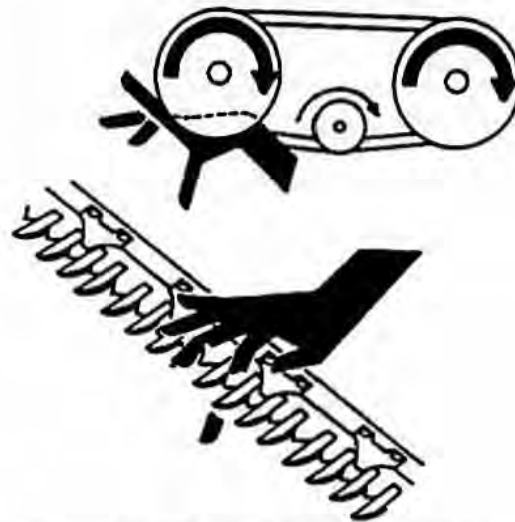

KEEP AWAY FROM MOVING PARTS



KEEP SERVICE AREA CLEAN AND DRY

SPECIFICATIONS

TRACTOR DIMENSIONS:

Weight (varies with tire size):

- with naturally-aspirated (N/A) diesel engine..... approx. 7225 lbs. (3275 kg)
- with turbocharged diesel engine..... approx. 7250 lbs. (3290 kg)

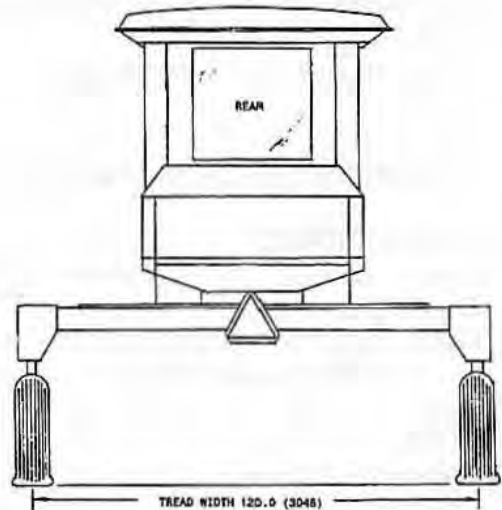
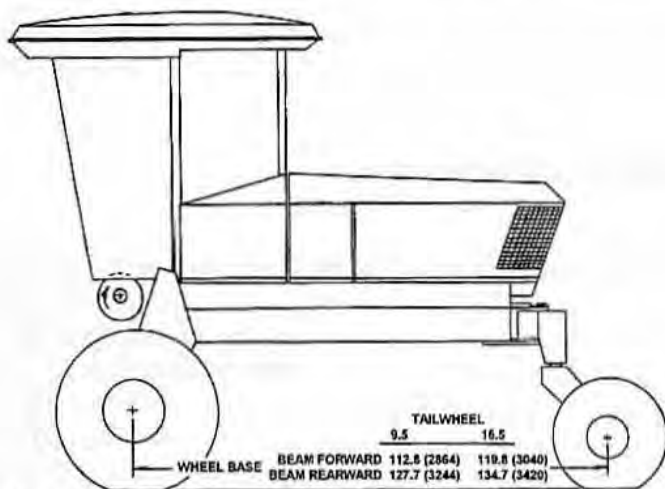
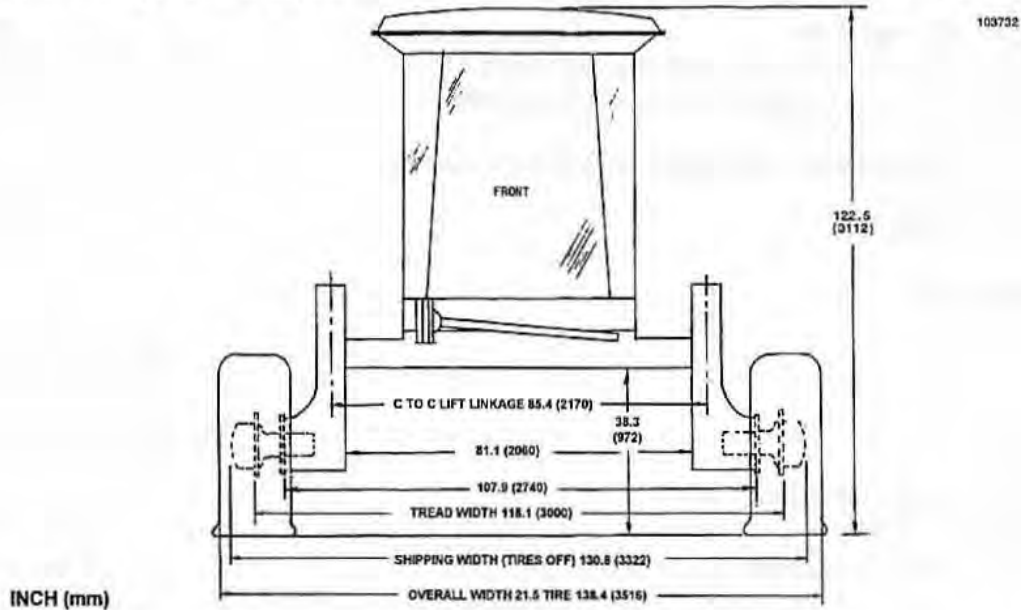

TRANSMISSION:

Type..... Hydrostatic
 Displacement..... 2.48 cu.in. (40.6 cc)
 Fluid..... See "Fuels, Fluids and Lubricants" in Maintenance/Service section

FINAL DRIVE:

Type..... Planetary Gear Drive
 Ratio..... 28.37 to 1
 Lubricant..... See "Fuels, Fluids and Lubricants" in Maintenance/Service section

SPEED RANGE:

Single Speed Forward..... 0 - 10 mph (16 km/h)
 Dual Speed Forward..... Field: 0 - 9 mph (14 km/h) Road: 0 - 16 mph (26 km/h)
 Reverse..... 0 - 5 mph (8 km/h)

HEADER DRIVE:

Mechanical..... 4-A section belt, electric over hydraulic clutch
 Hydraulic..... 2 circuits, clutch activated, w/ independent flow controls (3 - 9 US gpm each)

CYLINDER CONTROL VALVE:

Type..... Cartridge valves in manifold block

SPECIFICATIONS

ELECTRICAL:

Battery Requirement.....	12 Volt, minimum 560 CCA / recommended 640 CCA @ 0°F (-18°C)
Alternator	105 Amp
Breakers:	
Lights (manual re-set)	50 Amp
Main (all functions except lights, manual re-set).....	50 Amp
Air Conditioning, Header Controls and Seat Switch	25 Amp
Instruments and Radio.....	6 Amp
Wiper, Interior Lights, Radio Memory and Two-Way Radio.....	6 Amp
Fuses:	
Screen Motor	7.5 Amp
Cigar Lighter	20 Amp

AIR CONDITIONING:

Cooling Capacity.....	24,000 B.T.U./hour
Compressor	9.5 cu. in./rev., rotary

PARK BRAKE:..... Drum type, lever activated

DRIVE TIRES: Inflation Pressure

21.5L - 16.1 I3 Bar Tread.....	19 psi (132 kPa)
21.5L - 16.1 R3 Turf & Field, Softrac II, or Super Soft.....	19 psi (132 kPa)

TAIL WHEEL TIRES: Inflation Pressure

9.5L - 14 I1 Rib Implement	10 psi (70 kPa)
16.5L - 16.1 I1 8 ply Rib Implement.....	10 psi (70 kPa)

CAPACITIES: See "System Capacities" in Maintenance/Service section.

DIESEL ENGINES:

Type.....	Cummins 4-390, 4 Cylinder, 4 stroke cycle - Naturally Aspirated or Turbocharged
Displacement.....	239 cu. in. (3.92 L)
Power: Naturally Aspirated version.....	80 hp (60 kW) @ 2500 rpm
Turbocharged version.....	108 hp (80 kW) @ 2300 rpm
Bore	4.02 in. (102 mm)
Stroke.....	4.72 in. (120 mm)
Compression Ratio	17.0 to 1
Oil Type.....	See "Fuels, Fluids and Lubricants" in Maintenance/Service section
Oil Pressure: @ 2300 rpm	30 to 60 psi (210 to 415 kPa)
@ minimum (idle rpm)	13 psi (90 kPa)
Firing Order (No.1 cylinder at fan end)	1 - 3 - 4 - 2
Maximum (no load) Engine Speed: Naturally Aspirated version	2645 - 2705 rpm
Turbocharged version.....	2425 - 2475 rpm
Engine Idle Speed.....	1050 rpm
Rocker Arm-to-Valve Clearance: Exhaust.....	0.020 inch (0.50 mm)
Intake	0.010 inch (0.25 mm)

IMPORTANT: Rocker arm-to-valve clearance adjustments must be made with the engine not running.

Thermostat.....	180°F (82°C)
Fuel.....	See "Fuels, Fluids and Lubricants" in Maintenance/Service section
Engine Coolant	See "Fuels, Fluids and Lubricants" in Maintenance/Service section

NOTE: Specifications and design are subject to change without notice or obligation to revise units previously sold.

TORQUE SPECIFICATIONS

CHECKING BOLT TORQUE

The tables shown below give correct torque values for various bolts and capscrews. Tighten all bolts to the torques specified in chart unless otherwise noted. Check tightness of bolts periodically, using bolt torque chart as a guide. Replace hardware with the same strength bolt.

ENGLISH TORQUE SPECIFICATIONS

Bolt Diameter "A"	Bolt Torque *					
	SAE 2		SAE 5		SAE 8	
	N.m	(lb-ft)	N.m	(lb-ft)	N.m	(lb-ft)
1/4"	8	(6)	12	(9)	17	(12)
5/16"	13	(10)	25	(19)	36	(27)
3/8"	27	(20)	45	(33)	63	(45)
7/16"	41	(30)	72	(53)	100	(75)
1/2"	61	(45)	110	(80)	155	(115)
9/16"	95	(70)	155	(115)	220	(165)
5/8"	128	(95)	215	(160)	305	(220)
3/4"	225	(165)	390	(290)	540	(400)
7/8"	230	(170)	570	(420)	880	(650)
1"	345	(225)	850	(630)	1320	(970)

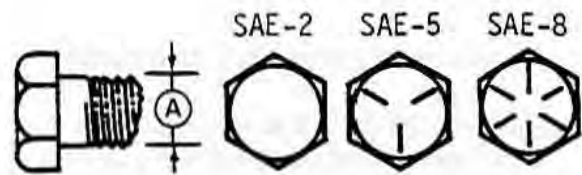

METRIC TORQUE SPECIFICATIONS

Bolt Diameter "A"	Bolt Torque			
	8.8		10.9	
	N.m	(lb-ft)	N.m	(lb-ft)
M3	.5	(.4)	1.8	(1.3)
M4	3	(2.2)	4.5	(3.3)
M5	6	(4)	9	(7)
M6	10	(7)	15	(11)
M8	25	(18)	35	(26)
M10	50	(37)	70	(52)
M12	90	(66)	125	(92)
M14	140	(103)	200	(148)
M16	225	(166)	310	(229)
M20	435	(321)	610	(450)
M24	750	(553)	1050	(774)
M30	1495	(1103)	2100	(1550)
M36	2600	(1917)	3675	(2710)

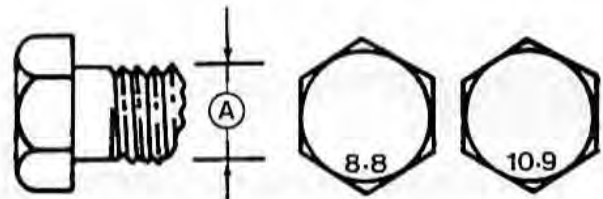

Torque figures indicated above are valid for non-greased or non-oiled threads and heads unless otherwise specified. Therefore, do not grease or oil bolts or capscrews unless otherwise specified in this manual. When using locking elements, increase torque values by 5%.

* Torque value for bolts and capscrews are identified by their head markings.

TORQUE SPECIFICATIONS

TIGHTENING HYDRAULIC O-RING FITTINGS*

1. Inspect O-ring and seat for dirt or obvious defects.
2. On angle fittings, back the lock nut off until washer bottoms out at top of groove.
3. Hand tighten fitting until back-up washer or washer face (if straight fitting) bottoms on face and O-ring is seated.
4. Position angle fittings by unscrewing no more than one turn.
5. Tighten straight fittings to torque shown.
6. Tighten angle fittings to torque shown while holding body of fitting with a wrench.

Thread Size (in.)	Nut Size Across Flats (in.)	Torque Value*		Recommended Turn to Tighten (After Finger Tightening)	
		(N.m)	(lb-ft)	(Flats)	(Turns)
3/8	1/2	8	6	2	1/3
7/16	9/16	12	9	2	1/3
1/2	5/8	16	12	2	1/3
9/16	11/16	24	18	2	1/3
3/4	7/8	46	34	2	1/3
7/8	1	62	46	1-1/2	1/4
1-1/8	1-1/4	102	75	1	1/6
1-3/16	1-3/8	122	90	1	1/6
1-5/16	1-1/2	142	105	3/4	1/8
1-5/8	1-7/8	190	140	3/4	1/8
1-7/8	2-1/8	217	160	1/2	1/12

* The torque values shown are based on lubricated connections as in reassembly.

TIGHTENING HYDRAULIC FLARE-TYPE TUBE FITTINGS*

1. Check flare and flare seat for defects that might cause leakage.
2. Align tube with fitting before tightening.
3. Lubricate connection and hand tighten swivel nut until snug.
4. To prevent twisting the tube(s), use two wrenches. Place one wrench on the connector body and with the second tighten the swivel nut to the torque shown.

Tube Size OD (in.)	Nut Size Across Flats (in.)	Torque Value*		Recommended Turns to Tighten (After Finger Tightening)	
		(N.m)	(lb-ft)	(Flats)	(Turns)
3/16	7/16	8	6	1	1/6
1/4	9/16	12	9	1	1/6
5/16	5/8	16	12	1	1/6
3/8	11/16	24	18	1	1/6
1/2	7/8	46	34	1	1/6
5/8	1	62	46	1	1/6
3/4	1-1/4	102	75	3/4	1/8
7/8	1-3/8	122	90	3/4	1/8

* The torque values shown are based on lubricated connections as in reassembly.

OPERATOR'S STATION

Symbol Definitions

The following symbols are used to depict functions or reactions at the various instruments and controls. Learn the meaning of these symbols before operating the Windrower.



- engine oil pressure



- head lights



- transmission oil pressure



- work (field) lights



- parking brake on

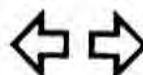

- turn signals



- engine hours



- temperature control (heater)



- voltage level



- temperature control:
air conditioning



- engine coolant temperature



- turn to increase output:
heater or air conditioner



- fuel



- blower



- flashing amber lights



- windshield wiper

OPERATOR'S STATION

Symbol Definitions (continued)

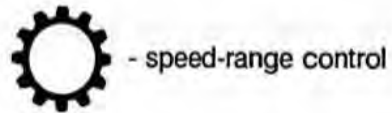
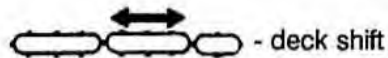
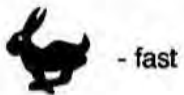
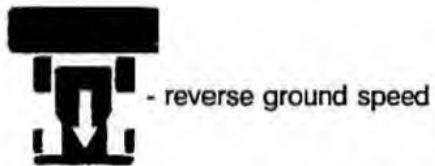
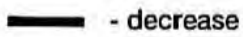
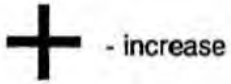
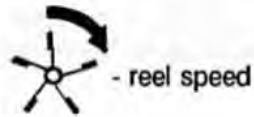
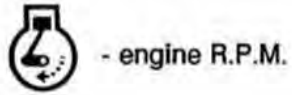

OPERATOR'S STATION



CAUTION: Learn and practice safe use of controls before operating.

IMPORTANT: See your Dealer if there are any instrument malfunctions. Operate windrower only if all instruments work properly.

Machine Monitors

The gauges allow the operator to monitor various machine systems, while the warning lights and buzzers are provided to alert the operator that continued operation will cause serious machine damage.

PARKING BRAKE LIGHT (A) - Both light and buzzer will be activated when ignition switch is turned to ON as a reminder to release brake before driving windrower. Release of brake deactivates light and buzzer.

TRANSMISSION OIL PRESSURE LIGHT (B) - Both light and buzzer will be activated when ignition switch is turned ON if transmission oil pressure is below 60 psi (415 kPa). Do not drive the windrower until light and buzzer go off. If light and buzzer stay on after engine starts, or if they activate during operation, shut engine off and check hydraulic oil level at reservoir. If oil level is adequate, measure relief pressure. See "Traction Drive: Hydraulics" in Maintenance/Service section.

ENGINE OIL PRESSURE LIGHT (C) - Both light and buzzer will be activated when ignition switch is turned ON if engine oil pressure is below 7 psi (50 kPa) for the gasoline engine or below 11 psi (75 kPa) for the diesel engine. If light and buzzer stay on for more than a few seconds after engine starts, or if they activate while engine is running, shut engine off and check engine oil level.

TACHOMETER (D) - (OPTIONAL) - Indicates engine speed in revolutions per minute (RPM).

ENGINE TEMPERATURE GAUGE (E) - Monitors the temperature of the engine coolant. With engine running, temperature gauge should read in the 180° - 225°F operating range (82° - 107°C). Allow engine temperature to rise to this range before beginning operation. If gauge reaches approximately 225°F (107°C) a warning buzzer will sound. Stop engine immediately and determine cause. (See Trouble Shooting section.)

NOTE: If a buzzer sounds when engine temperature is below 225°F (107°C) and no indicator light [(A), (B) or (C)] illuminates, check bulbs.

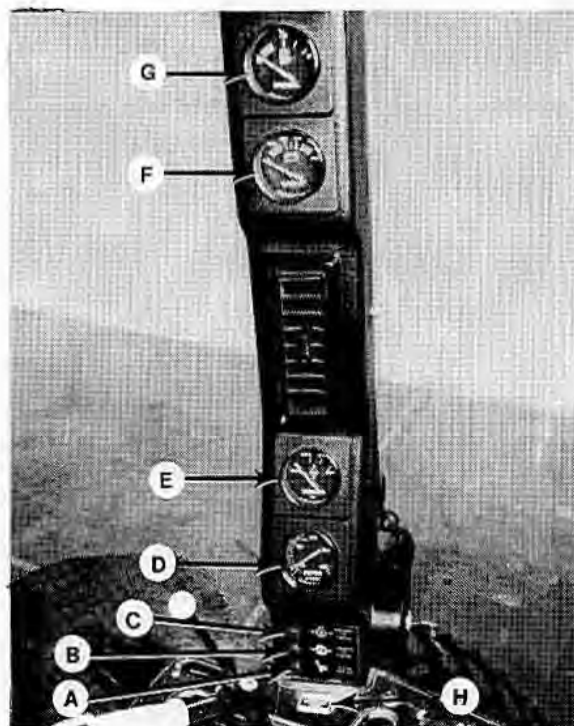

MACHINE MONITORS

VOLT METER (F) - Indicates condition of battery and alternator. With key switch in the ON position and the engine NOT running, a reading of 12 indicates fully charged battery. Watch for changes in the volt reading:

Reading (engine running)	Indicated Condition
14	normal
over 16	regulator misadjusted
under 12	alternator not working or regulator misadjusted

FUEL GAUGE (G) - Indicates fuel level in tank. Check fuel gauge before beginning day's operation. Stop to refuel before fuel gauge reaches empty mark. Use fuel specified under "Fuels, Fluids and Lubricants" in Maintenance/Service section.

For diesel only, should engine run out of fuel and not start in several tries, air must be bled from the fuel system. See "Fuel System Air Removal" in Maintenance /Service section.

HOURLY METER (H) - Shows total engine operating time in hours and tenths.

NOTE: Hour meter is activated when key switch is in the ON position.

OPERATOR'S STATION

Ignition Switch

The ignition switch (A) has three positions; OFF, RUN and START.

The furthest counter-clockwise position of the key is OFF. Turn key fully clockwise to START. Holding key in this position will cause engine to crank.

Release of key will return to the vertical RUN position.

Lights

LIGHT SWITCH (B) - The light switch has four positions:

1. OFF - Furthest counter-clockwise position. To turn off all lamps.
2. FLASHER - To turn on flashing amber lamps and red tail lamp. (For use when windrower is being hauled by a towing vehicle.)
3. ROAD - To turn on head lamps, flashing amber lamps and red tail lamp. (For driving on roadways.)
4. FIELD - To turn on head lamps and field lamps. For field use ONLY.



CAUTION: When operating on a roadway, switch to the ROAD position. Never use field lamps or any lights which might confuse other drivers. Always use flashing amber lamps when driving or hauling on roadways, unless prohibited by law.

TURN SIGNAL SWITCH (C) - When operating windrower on a roadway, use turn signals as you would in a car or truck.

Turn signals will work with flashers on or off. Moving switch to left or right will flash turning side lamps with other side steady. Turn indicators (D) are located on headliner.

NOTE: Be sure to return switch (C) to center position after turning.

REAR VIEW MIRROR (E) - Adjust mirror for best view.

DOME LIGHT (F) - Pushing button on dome light turns light ON and OFF.

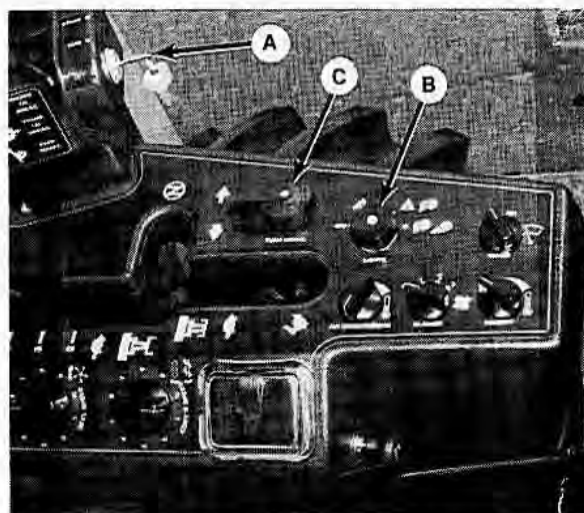

IGNITION SWITCH AND LIGHTS

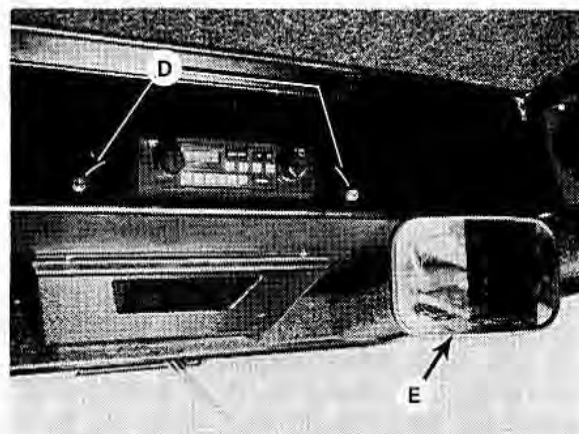

TURN INDICATORS & MIRROR

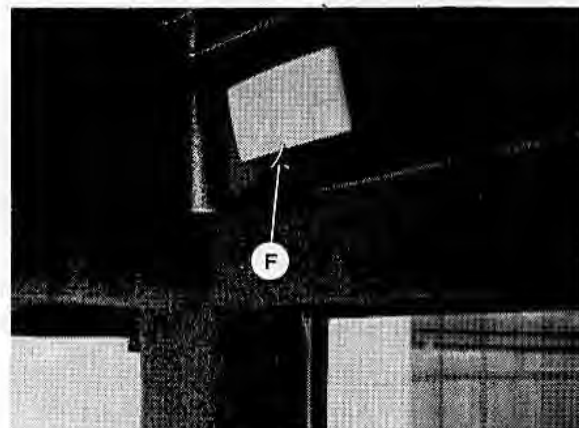

DOME LIGHT - RIGHT REAR CORNER

OPERATOR'S STATION

Cab Temperature Controls

NOTE: For servicing electrical components in cab side console, remove access panel on window side of console.

BLOWER SPEED SWITCH (A) - Controls operation of blower. Four positions are: OFF, LOW, MEDIUM and HIGH. The blower recirculates cab air as well as drawing in outside air to pressurize the cab.

With door and window closed and blower on, dust and dirt will be filtered out to keep cab interior clean. Adjust circular louvers (B) (both sides) to direct air where needed, for example, to defog window. Rectangular louvers (C) (both sides) may be shut off or opened and adjusted to operator preference.

AIR CONDITIONING TEMPERATURE CONTROL (D) - Air conditioning is OFF when control (D) is turned fully counter-clockwise. Turning control clockwise decreases cab temperature. Blower switch (A) must also be turned ON before air conditioning system will operate.

Regulate cab temperature with air conditioning control and blower speed.

IMPORTANT: If humidity is high it may be necessary to run blower at HIGH speed to prevent evaporator freeze up.

HEATER TEMPERATURE CONTROL (E) - Heater is off when control (E) is turned fully counter-clockwise. Turning control clockwise increases cab temperature. Regulate cab temperature with heater control and blower speed.

NOTE: Heat and air conditioning systems are independent of each other. To avoid working one system against the other, be sure the system not in use is turned OFF at the appropriate temperature control, unless both are required to defog windows. There is also a shut-off valve for the heater circuit at the engine. Valve must be open for heater to function. For maximum cooling in hot conditions, close valve (G).

NOTE: If windows fog up, run the air conditioning to dehumidify the cab air, plus the heater to control cab temperature.

Windshield Wiper Control

Control windshield wiper using knob (F). The wiper is a manual park type. To park wiper blade, turn wiper switch OFF when blade is at extreme end of stroke.

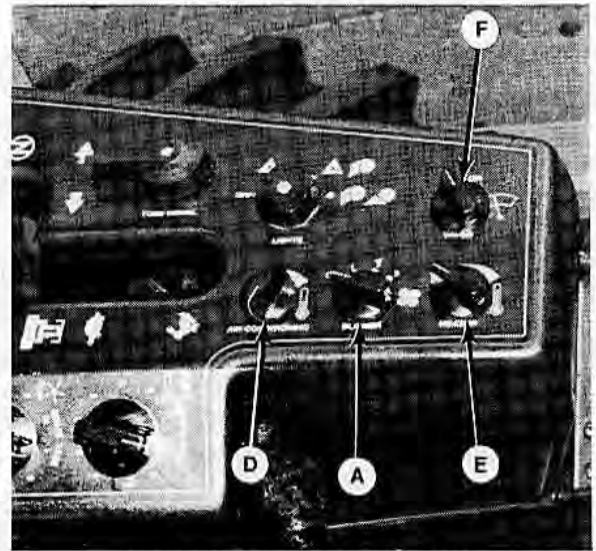

CAB TEMPERATURE AND WIPER CONTROLS

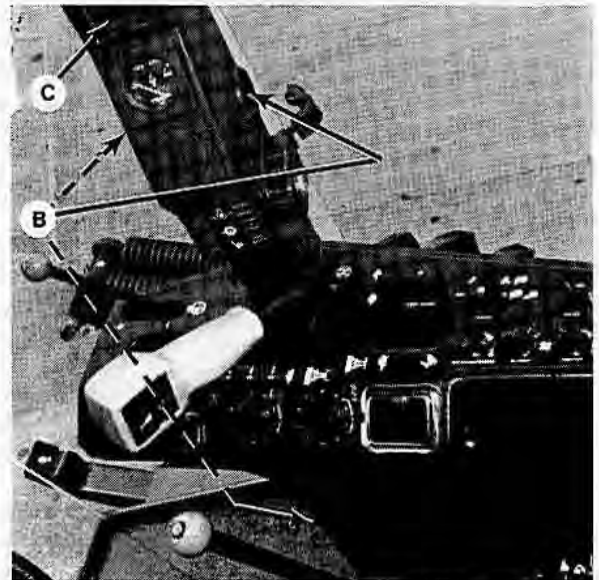

DIRECT AIR FLOW WITH LOUVERS

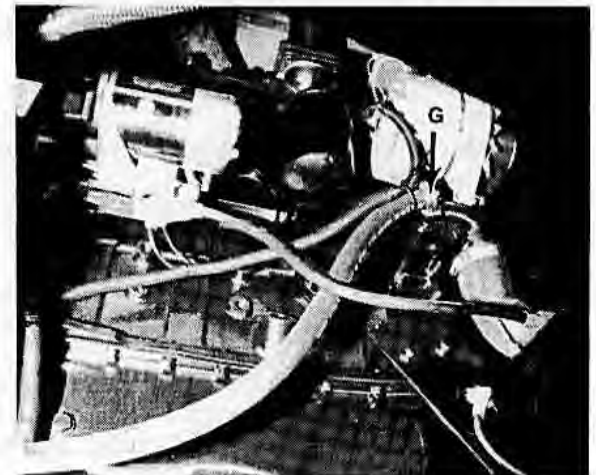

HEATER SHUT-OFF VALVE

OPERATOR'S STATION

Windrower Controls

VARIABLE GROUND SPEED CONTROL LEVER

(A) Controls windrower direction of movement and rate of speed. A neutral start switch prevents the starter from engaging unless this lever is in the neutral detent as shown and the steering is locked in the straight ahead position.

For forward motion: Push lever forward. The further the lever is moved from neutral the faster the speed. Release lever at desired speed and lever will engage friction device to secure the position. **NOTE:** The numbers 2 through 9 to the left of ground speed lever indicate speed in miles per hour (in Field Speed Range).

For reverse motion: Pull lever rearward. The further the lever is moved from neutral the faster the speed.

SPEED-RANGE CONTROL (B) (if equipped) -

Shifts the transmission to FIELD or ROAD speed range. The shifting mechanism may sometimes be hard to shift with ground speed lever in neutral. If so, shift "on-the-go" with ground speed lever set at the slow end of its range.

To avoid sudden changes in ground speed, stroke lever slowly.

When shifting, lever will reach a point where it becomes harder to move. Continue pulling or pushing on lever until you feel a distinct engagement.

Field Speed Range: Handle Rearward This setting is for windrower operating speeds (0 to 9 mph [14 km/h]). Steering is less sensitive in this range.

Road Speed Range: Handle Forward This setting is for transport speeds (0 to 16 mph [26 km/h]). Steering is more sensitive in this speed range.



WINDROWER CONTROLS

THROTTLE LEVER (C) - Push lever forward to increase engine speed (RPM) and rearward to decrease. Full forward is operating RPM.

PARK BRAKE LEVER (D) - Pull up on lever to engage brake. Push down to release.



CAUTION: Use park brake only when windrower is stopped. Do not use park brake to slow windrower when moving. Use variable speed lever to slow and stop machine.

STEERING WHEEL

To adjust steering wheel tilt:

1. Pull handle (F) towards seat to loosen steering column pivot.
2. Move steering wheel to desired position.
3. Push handle forward to lock the position.

NOTE: The travel arc of handle (F) can be repositioned as follows:

1. Loosen the handle 4 or 5 turns.
2. Reposition the head of carriage bolt (G) in square hole. (Index the bolt head in the opposite direction you want travel arc to move.)
3. Tighten handle.

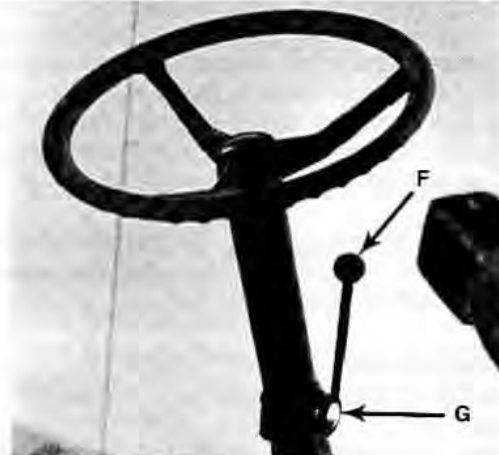

STEERING WHEEL

OPERATOR'S STATION

Header Controls

NOTE: Some of these controls are not used for all types of headers. Some are optional equipment and may not be present in your unit. For others, while the switch may be installed, it will be non-functional for certain headers.

HEADER DRIVE SWITCH (A) - Lift the guard to expose toggle switch. Push toggle switch forward to engage all header mechanical and hydraulic drives. Push guard down to disengage drives. Starter will not engage if switch is in the engaged position.

NOTE: Always move throttle lever back to idle before engaging header drives. Do not engage with engine at full RPM.

REEL SPEED CONTROL (B) - Turn knob clockwise to increase reel speed and counterclockwise to decrease. Speed range is:

920 Header: 30 to 75 RPM

932 Header: 30 to 69 RPM

942, 960, 962, 970 Headers: 20 to 60 RPM

CONVEYOR SPEED CONTROL (C) - Turn knob clockwise to increase conveyor speed and counterclockwise to decrease. Speed range is:

942 augers: 175 - 500 RPM

960, 962, 970 drapers: 170 to 500 ft/min
(50 - 155 m/min)

SETTING CONTROLS (B) & (C)

920, 932 Headers - Both controls (B) and (C) affect reel speed. Set conveyor speed knob (C) to "10" and adjust reel speed knob (B) to obtain desired reel speed.

942, 960, 962, 970 Headers - For stable flow controller response, knobs (B) and (C) position readings must not exceed 16. If the sum of the knob position readings exceeds 16, reel and conveyor speeds will fluctuate as the load varies.

Example 1 - If fastest possible reel speed is desired, turn knob (B) to "10". Knob (C) must then not be turned higher than position "6".

Example 2 - If fastest possible conveyor speed is desired, turn knob (C) to "10". Knob (B) must then not be turned higher than position "6".

Example 3 - If high reel and conveyor speed are both desired, turn both knobs (B) and (C) to position "8"

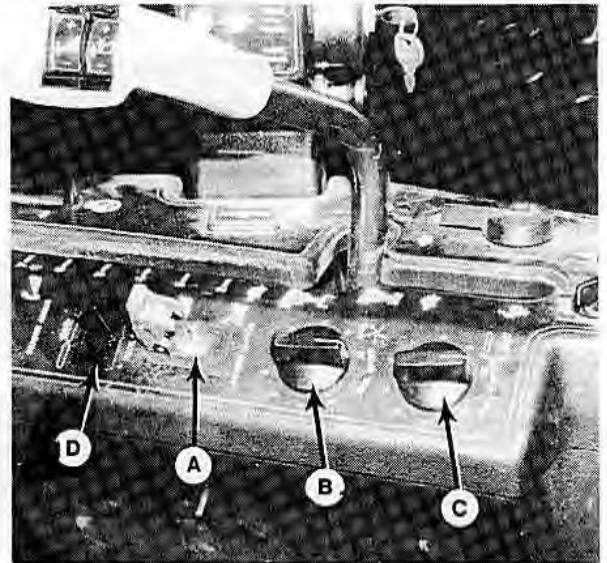

HEADER DRIVE / CONVEYOR SPEED /
REEL SPEED / DECK SHIFT CONTROLS

DECK SHIFT SWITCH (D) - Move switch paddle to the left to shift decks to the left and reverse draper travel. Move paddle to the right to shift decks to the right and reverse draper travel. For center delivery, move paddle to center position.

OPERATOR'S STATION

Header Controls (continued)

REEL HEIGHT SWITCH (E) - Press top of switch to raise reel and bottom to lower. Hold switch until reel reaches desired position.

HEADER HEIGHT SWITCH (F) - Press top of switch to raise header and bottom to lower. Hold switch until header reaches desired position. (See "Cut Height Indicator").

NOTE: Handle may be rotated on lever to allow the operator to position switches (E) and (F) for maximum comfort. To adjust, loosen set screws (K).

IMPORTANT: Do not continue pressing switches (E) or (F) after header or reel travel is complete. If switch is held for a long period of time, damage may occur due to overheating electrical solenoids and/or overheating hydraulic oil which is pumped through relief valve.

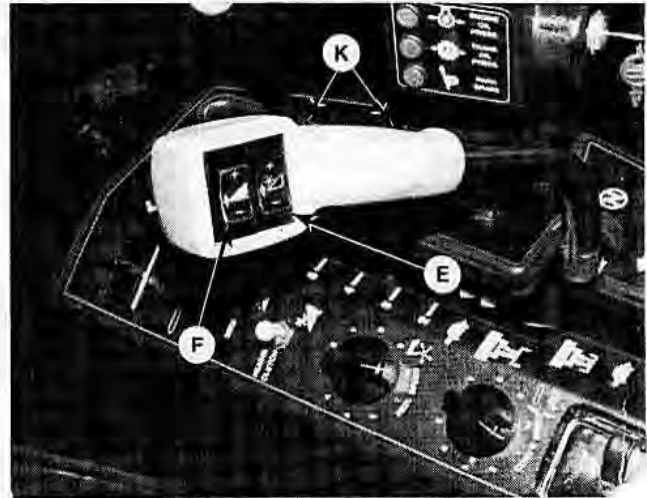

REEL & HEADER HEIGHT SWITCHES

CUT HEIGHT INDICATOR (G) - The gauge on the lift linkage can be used to identify desired cut heights.

With the center link (between tractor and header) in a mid-range position, the numbers on the gauge indicate approximate cut (stubble) height in inches. Adjusting center link length will affect the starting point; eg. gauge reading 4 may indicate a 3" (longer center link) or 5" (shorter center link) cut height. However, the difference between gauge readings of 4 and 8, 8 and 12, etc. will always be about 4 inches, regardless of center link length.

Header Angle: Cut height indicator (G) can also be used to identify header angle when cutting with header on the ground. The gauge indicator will decline until header contacts ground, then as header height switch is held in down position, the indicator reading will increase as header angle steepens. The gauge numbers will not correspond to actual header angle, but can be used to identify a desired setting. See "Header Angle" in Operation section for adjustment procedure.

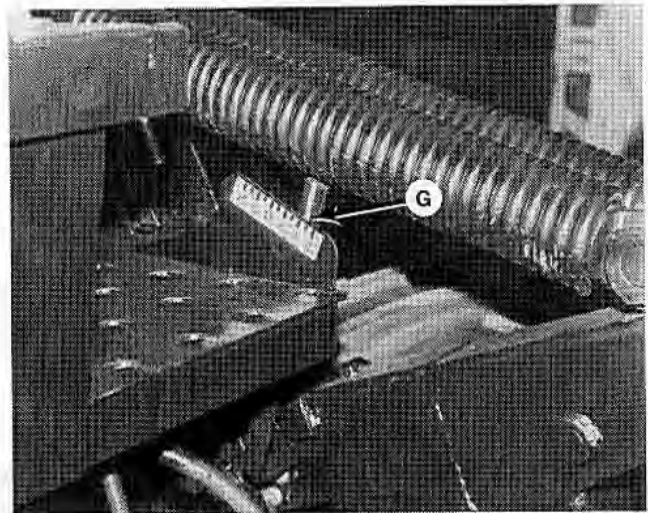

CUT HEIGHT INDICATOR

OPERATOR'S STATION

Seat

OPERATOR WEIGHT & SEAT HEIGHT ADJUSTMENT

Press knob (A) in to increase suspension stiffness and seat height. Pull knob out to decrease.

SEAT-BACK ANGLE

Pull up on lever (B), position seat-back as desired, and release lever.

LUMBAR SUPPORT

Rotate knob (C) to position lumbar support as desired.

SEAT FORE-AFT POSITION

To adjust, pull out on lever (D), move seat forward or rearward to desired position and release lever.

SEAT FORE-AFT ISOLATOR LOCKOUT

To lock out fore-aft isolator, push down on lever (E).

ARM REST

Arm rest has two positions, vertical and horizontal. Raise left hand arm rest when leaving seat for easier exit and re-entry.

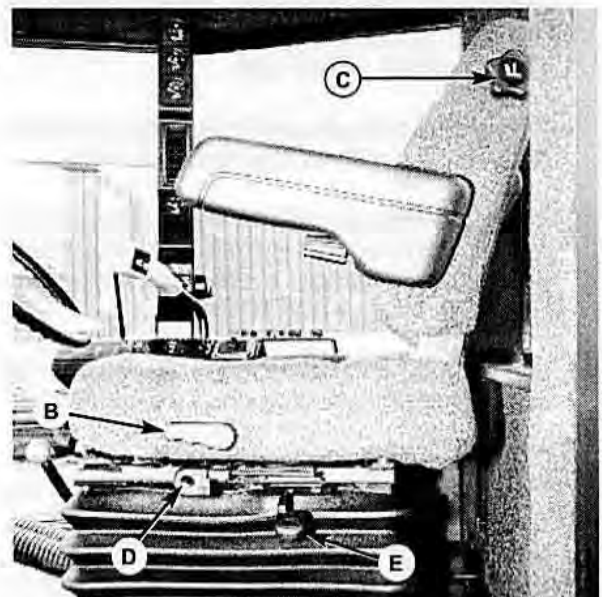
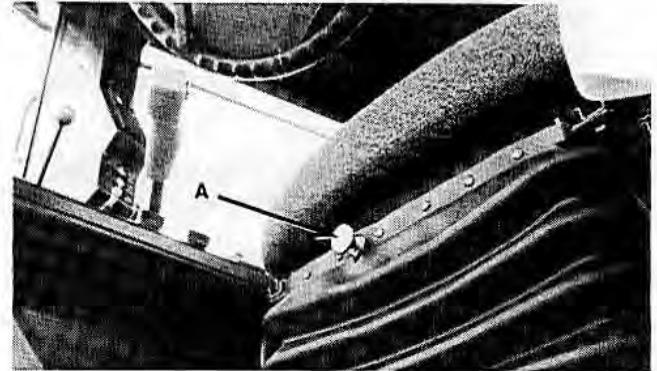

AIR SUSPENSION SEAT

OPERATION

Your Responsibilities as an Owner/Operator



CAUTION:

1. It is your responsibility to read and understand this manual and the Header Operator's Manual completely before operating the windrower. Contact your dealer if an instruction is not clear to you.
2. Follow all safety messages in the manuals and on safety signs on the windrower.
3. Remember that YOU are the key to safety. Good safety practices protect you and the people around you.
4. Before allowing others to operate the windrower, for however short a time or distance, make sure they have been instructed in its safe and proper use.
5. Review the manuals, safety signs and all safety related items with all operators annually.
6. Be alert for other operators not using recommended procedures or not following safety precautions. Correct these mistakes immediately, before an accident occurs.
7. Maintain the windrower correctly. Be sure all controls are functioning properly before use.
8. Do not modify windrower or remove shields. Unauthorized modifications may impair the function and/or safety and affect machine life.
9. Install a fire extinguisher and keep it properly charged.
10. The safety information given in this manual does not replace safety codes, insurance needs or laws governing your area. Be sure your windrower meets the standards set by these regulations.



READ THE OPERATOR'S MANUAL

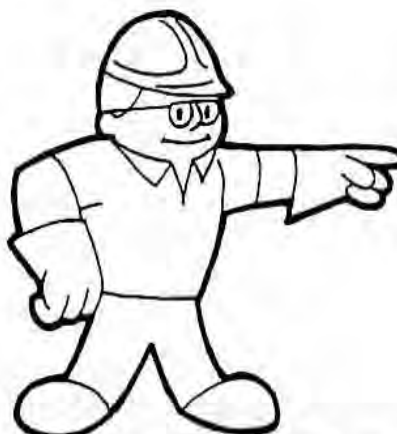

FOLLOW SAFETY RULES

To the New Operator

It's natural for an operator to be anxious to get started with a new machine. Please take the time to familiarize yourself with the windrower by reading the Operator's Manuals and safety signs before attempting operation. Study the Starting, Driving and Stopping procedures so you will know what to expect.

OPERATION

Break-in Period

The windrower is ready for normal operation. However there are several items to check and watch out for during the first 100 hours, as follows:

ENGINE BREAK-IN:

1. Operate engine at moderate load, avoid extremely heavy or light loading for longer than 5 minutes.
2. Avoid unnecessary idling. If engine will be idling for longer than 5 minutes after reaching operating temperature, turn key OFF to stop engine.
3. Check engine oil level frequently. Watch for any signs of leakage. If oil must be added, use oil specified under "Fuels, Fluids and Lubricants" in Maintenance/Service section.

NOTE: During the break-in period, a higher than usual oil consumption should be considered normal.

If windrower must be driven in cold weather (below freezing), let engine idle for 3 minutes, then operate at moderate speed until oil has warmed up.

4. Watch coolant gauge in cab for temperature rising beyond normal operating range. Check that coolant level at reserve tank (mounted next to radiator) stays between HOT and COLD marks on tank. If over-heating problems occur, check for coolant leaks. See "Cooling System" in Maintenance/Service section.
5. Change engine oil and filter after the first 25 hours and every 200 hours or at least once per season thereafter. See "Engine" in Maintenance/Service section.

WINDROWER BREAK-IN:

1. Until you become familiar with the sound and feel of your new windrower, be extra alert and attentive.
2. Check A/C compressor belt after 5 hours operation for initial stretch. Tighten as necessary. (See Maintenance/Service section). Continue to check the belt periodically for the first 50 hours.
3. Check wheel bolt torque after the first 5 hours and periodically thereafter (at least every 1000 hours).
Drive wheels: DRY: 150 - 160 ft.lbs. (205 - 215 N·m) / LUBRICATED: 110 - 120 ft.lbs. (150 - 165 N·m)
Caster wheels: 8.5L-14 or 9.5L-14: 50 to 60 ft.lbs. (70 to 80 N·m)
16.5L-16.1: 80 to 90 ft.lbs. (110 to 120 N·m)

NOTE: To avoid damage to wheel disks, do not over-tighten wheel nuts.

4. Replace both hydraulic oil filters after the first 10 hours and every 300 hours thereafter. See "Hydraulic System" in Maintenance/Service section.
5. Adjust park brake after the first 10 hours and every 100 hours thereafter. See Park Brake in Maintenance/Service section.
6. Change power wheel oil after the first 50 hours and every 1000 hours (or 3 years) thereafter. See Maintenance/Service section.

OPERATION

Pre-Starting Checks: Annual

Do the following at the start of each operating season:



CAUTION:

1. Review the Operator's Manual to refresh your memory on safety and operating recommendations.
2. Review all safety signs and other decals on the windrower and note hazard areas.
3. Be sure all shields and guards are properly installed and secured. Never alter or remove safety equipment.
4. Re-acquaint yourself with the controls before beginning operation.
5. Store a properly stocked first aid kit and charged fire extinguisher on the windrower.

Also:

6. Drain off excess hydraulic oil added for storage. See "Hydraulic System" in Maintenance/ Service section.
7. Remove plastic bags and/or tape from all sealed openings (air cleaner intake, exhaust pipe, fuel tank).
8. Charge battery and install. Be sure terminals are clean and cables are connected securely.
9. Adjust tension on A/C compressor belt. See Maintenance/Service section.
10. Cycle blower switch to distribute A/C refrigerant oil. See Maintenance/Service section.
11. Perform all Annual maintenance. See Maintenance/Service section.

OPERATION

Pre-Starting Checks: Daily

Do the following each day before starting the engine:



CAUTION:

1. Clear the area of other persons, pets, etc. Keep children away from machinery. Walk around the windrower to be sure no one is under, on or close to it.
2. Remove foreign objects from the windrower and surrounding area.
3. Wear close-fitting clothing and protective shoes with slip resistant soles.

As well, carry with you any protective clothing and personal safety devices that **COULD** be necessary through the day. Don't take chances.

You may need:

- a hard hat
- protective glasses or goggles
- heavy gloves
- respirator or filter mask
- wet weather gear

4. Protect against noise. Wear a suitable hearing protective device such as ear muffs or ear plugs to protect against objectionable or uncomfortable loud noises.
5. Check the machine for leaks or any parts that are loose, missing, broken, or not working correctly. Use proper procedure when searching for pressurized fluid leaks. See "Fuel System" and "Hydraulic System" in Maintenance/Service section.
6. Clean the windows and mirror to be sure of good visibility in all directions. To wash front window, stand on side platforms and use grab handle on cab side posts. **DO NOT** stand on back tube of header.
7. Clean all lights and reflective surfaces to be sure you are visible to others.
8. Perform all Daily Maintenance. See Maintenance/Service section.



PROTECT YOURSELF



PROTECT AGAINST NOISE



WASHING FRONT WINDOW

OPERATION

Start-Up Procedure



DANGER: Avoid possible injury or death from a runaway machine.

Do not start engine by shorting across starter terminals. Machine will start in gear and move if normal starting circuitry is bypassed.

This machine has two safety devices which prevent the engine from starting unless the variable speed lever is in neutral, the steering wheel is locked in the neutral position, and the header drive switch is in the OFF position. Under no circumstances are these circuits to be deliberately rewired so that the engine can be started with controls out of neutral.

Start engine only from operator's seat with controls in neutral. NEVER start engine while standing on ground. Machine will start in gear and move if normal starting circuitry is bypassed.

Before starting engine, be sure there is plenty of ventilation to avoid asphyxiation.

IMPORTANT: Do not tow machine to start engine. Damage to hydrostatic drives will result.

ADJUSTING CONTROLS

1. Engage park brake (A).
2. Move header drive switch (B) to off position.
3. Move variable speed lever to neutral position (C).
4. Turn steering wheel until it locks. Adjust steering wheel tilt to desired position.
5. Move throttle lever (D) to start-up position:
0° C (32° F) and up - Lever fully back.

Below 0° C - Lever fully forward.

CHECKING INSTRUMENTS

The machine gauges and instruments provide important information about machine operation and condition. Familiarize yourself with the gauges and monitor them carefully during start-up operation. See "Instruments and Controls".



NEVER SHORT ACROSS STARTER TERMINALS

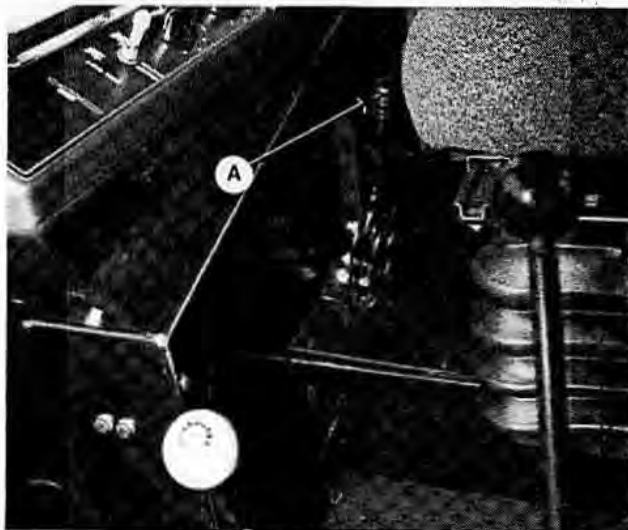

ENGAGE PARK BRAKE



ADJUST CONTROLS FOR START-UP

OPERATION

Start-Up Procedure (continued)

STARTING ENGINE



CAUTION: Be sure the area is clear of other persons, pets etc. before proceeding.

Turn ignition key to START position until engine starts. Release key.

IMPORTANT: Do not operate starter for longer than 15 seconds at a time. If engine does not start, wait at least two minutes before trying again. After the third 15 second crank attempt, allow solenoid to cool for 10 minutes before further cranking attempts. If engine still does not start, refer to Trouble Shooting section.



WARNING: If starter engages with steering wheel unlocked, variable speed lever out of neutral, or header clutch engaged, **DO NOT START ENGINE.** Perform Neutral Lock Adjustment. (See Maintenance/Service section.)

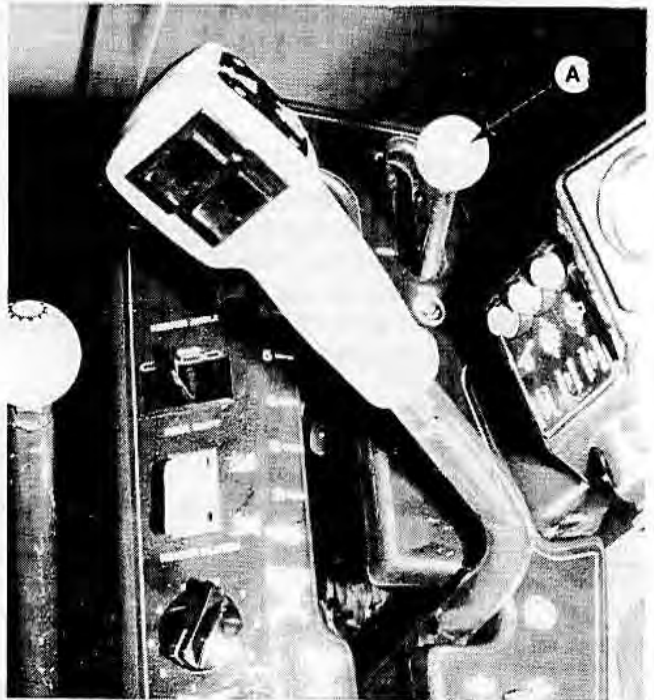

THROTTLE - IDLE POSITION

WARMING UP ENGINE

Allow engine to run with throttle lever (A) at or near low idle position until temperature gauge reaches approximately 180°F (80°C).

USING A BOOSTER BATTERY

If battery charge is low and engine fails to start, an extra 12-volt battery can be connected in parallel with the windrower battery. Follow directions carefully. See "Connecting Booster Battery" in Maintenance/Service section.

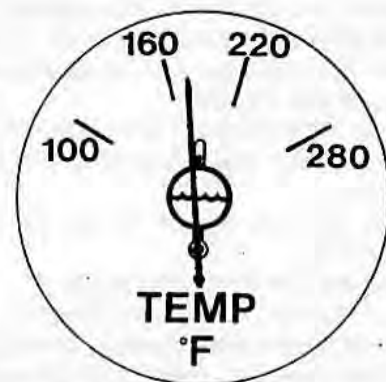

ALLOW ENGINE TO REACH OPERATING TEMPERATURE

OPERATION

Driving the Windrower



WARNING: • Avoid driving the machine with header removed. Removing header decreases the weight on drive wheels, reducing steering control.

- If necessary to drive machine with header removed, use transmission "field speed" range, do not exceed half maximum engine speed and avoid loose gravel and slopes.
- Never use windrower as a towing vehicle when header is removed. There is insufficient weight on the drive wheels to provide steering control.
- Because of windrower shape characteristics, a roll-over protected (ROPS) cab is not required. If operating with header removed, be aware that the cab structure will not withstand a roll-over.



CAUTION: HYDROSTATIC STEERING
The machine is steered hydrostatically, that is, turning the steering wheel varies the hydraulic flow to one drive wheel relative to the other drive wheel. The

reaction of this type of steering is different than conventional steering mechanisms.

Remember:

- With the engine running and the variable speed lever in neutral, the machine will move if the steering wheel is turned.
- Hydrostatic steering is more sensitive than mechanical steering.
- Steering is opposite to normal when driving in reverse.



CAUTION: 1. Never move variable speed lever or steering wheel until you are sure all bystanders have cleared the area.

2. Be sure area is clear before making turns, ends of header travel in a large arc.
3. Check the operation of all controls in a safe, clear area before starting work. Be sure you know the capacity and operating characteristics of this machine.
4. Do not allow riders in or on the machine.
5. Operate only while seated in the operator's position.
6. Never attempt to get on or off a moving windrower.
7. Avoid sudden starts and stops.
8. Avoid inclines, ditches and fences.
9. Reduce speed when turning, crossing slopes, or when travelling over rough ground.
10. Do not allow anyone to stand behind the machine while operating. Foreign objects may be forcibly ejected.



AVOID DRIVING WITH HEADER REMOVED

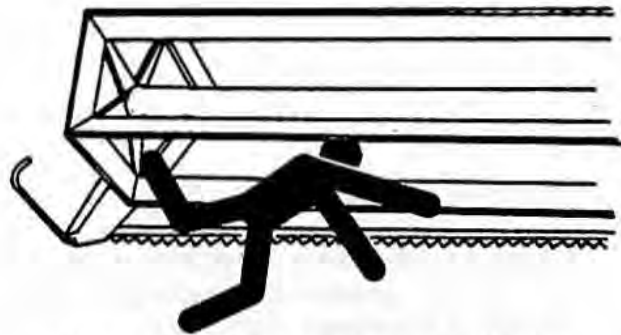

CLEAR THE AREA BEFORE OPERATING



DO NOT ALLOW RIDERS

OPERATION

Driving the Windrower (continued)

TO DRIVE FORWARD:

1. After starting engine, release park brake. If buzzer and warning lights remain on, shut engine off and refer to Trouble Shooting section to determine cause.
2. Dual Speed Units: For field operation, set speed-range control to position (A). For road speeds, set control to position (B).
NOTE: Speed-range control may sometimes be hard to shift with ground speed lever in neutral. If so, set the speed range control just after you start moving (with ground speed lever at the slow end of its range.) Be sure lever locks in over-center position when shifting.
3. Slowly push throttle lever (C) to full forward (operating speed).

IMPORTANT:

- Return throttle lever (C) to low idle position before engaging header drives.
- For field operation, always operate windrower with speed-range control in field position and throttle lever fully forward (maximum engine RPM). Use controls to vary ground speed, reel speed and conveyor speed. All systems are designed for efficient operation at maximum engine RPM.



CAUTION: Check again to be sure all bystanders have cleared the area.

4. Slowly move variable ground speed lever (D) forward to desired speed.
NOTE: With speed range control in field position, the numbers 2 to 9 adjacent to ground speed lever indicate speed in miles per hour.



CAUTION: Operate both steering wheel and variable speed lever slowly for familiarization. Remember that steering is more sensitive when speed-range control is in Road Speed Position. Avoid the common tendency of new operators to over-steer.

5. In situations where more tractive (lugging) power is required, for example, driving up a ramp, up a hill, or up out of a ditch:
Be sure speed-range control is in field position and move the variable speed lever towards neutral. The effect of this is similar to down-shifting a standard transmission, increasing torque at the drive wheels.

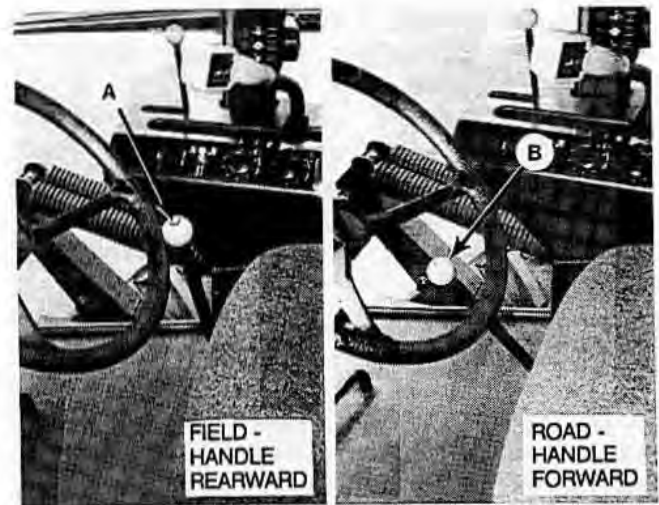

SPEED-RANGE CONTROL

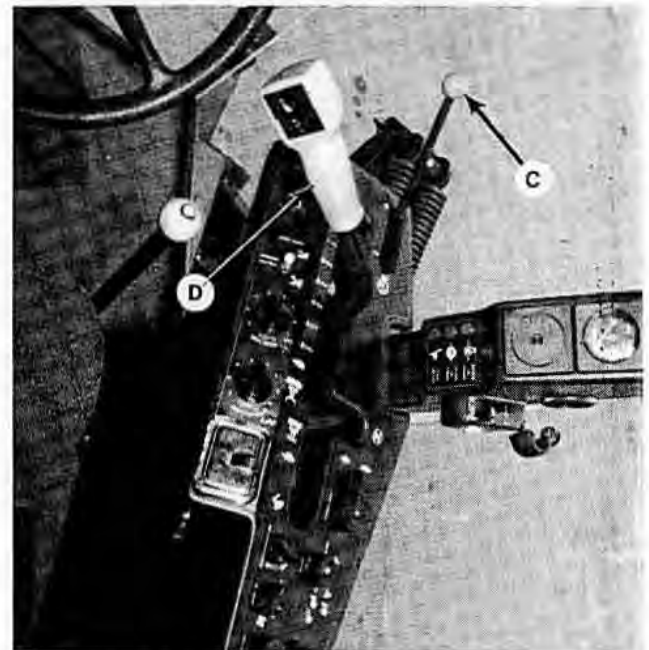

CONTROL LEVERS - DRIVING FORWARD

OPERATION

Driving the Windrower (continued)

TO DRIVE REARWARD:



WARNING: Back up slowly. Steering is opposite to normal when reversing. Hold steering wheel at the bottom and turn wheel in direction you want the rear of the machine to travel.

1. Move speed-range control to field position (A) (dual speed units).
2. Move throttle lever to a mid-range position (B).

NOTE: Reversing in low speed-range and at reduced engine speed is recommended since steering will be less sensitive than at higher speed settings.



CAUTION: Check again to be sure all bystanders have cleared the area.

3. Move variable ground speed lever (C) rearward to desired speed.

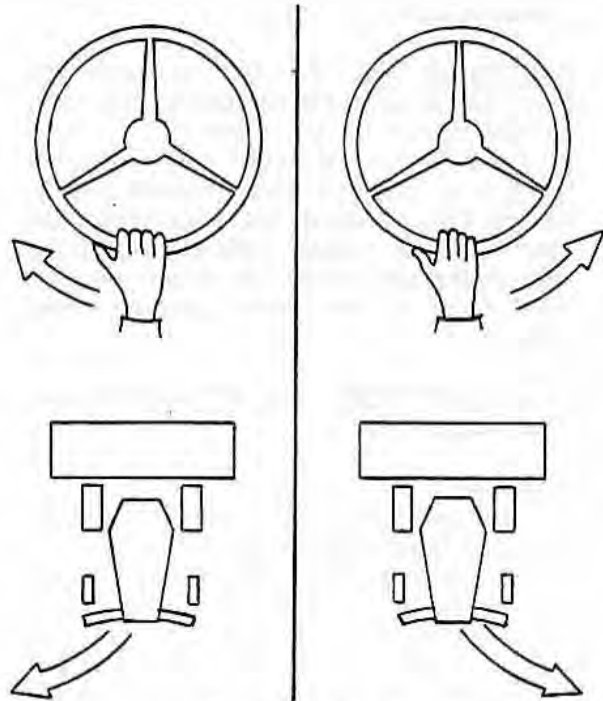

STEERING OPPOSITE TO NORMAL
WHEN REVERSING

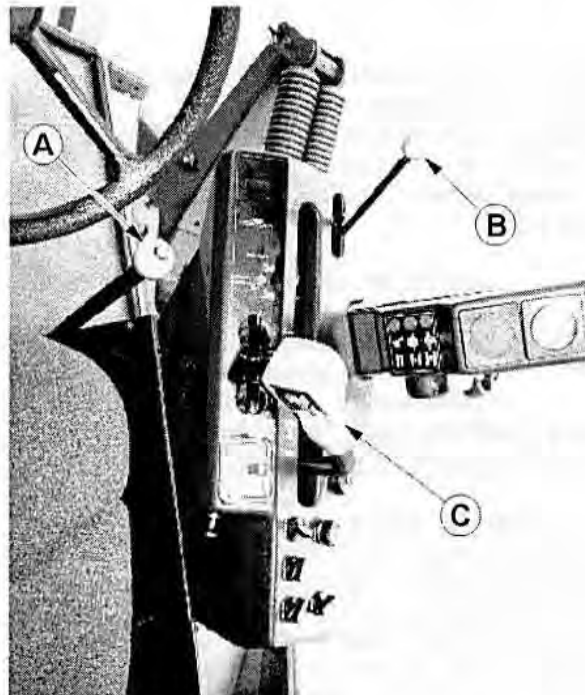

CONTROL LEVERS - DRIVING REARWARD

OPERATION

Driving the Windrower (continued)

MAKING A SPIN TURN:

Hydrostatic steering gives the operator significantly more maneuverability than mechanical steering.



CAUTION: Be sure area is clear before making turns. Although tractor pivots "on the spot", ends of header travel in a large arc.

To make a spin turn:

1. Move the variable speed lever (A) out of its neutral detent (towards the seat, not forward or rearward).
2. Slowly turn the steering wheel in the desired direction of turn. The windrower will pivot between the drive wheels.
3. To stop the turn, slowly turn the steering wheel back to its centered position.
4. To increase the turn radius, slowly move the ground speed lever away from neutral. Remember that this will increase ground speed as well.
5. To stop the turn, return all controls to neutral.

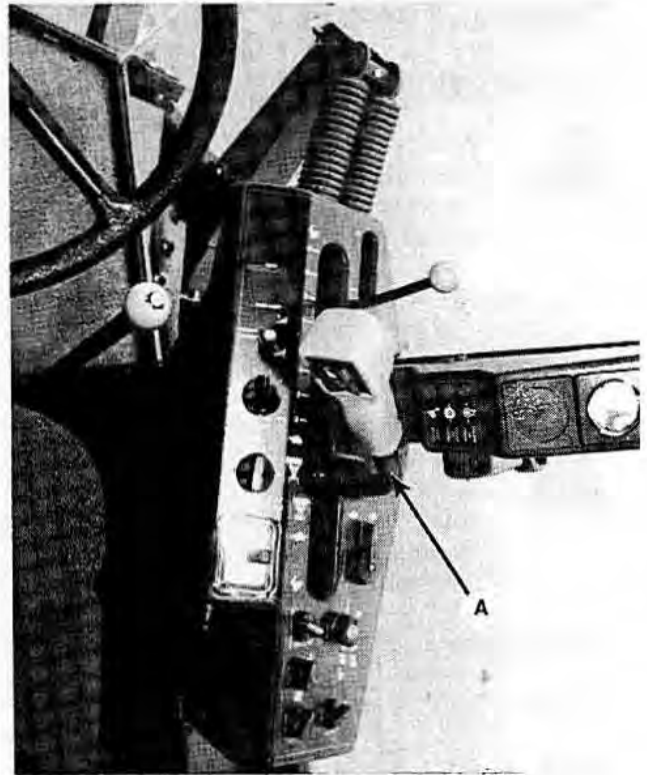

CONTROL LEVERS - SPIN TURN

OPERATION

Stopping Procedure

TO STOP WINDROWER:



WARNING: Do not move variable speed lever rapidly back to neutral. Operator may be thrown forward by sudden stop.

1. To slow down and stop the windrower, SLOWLY return the variable speed lever (A) to neutral.



WARNING: Do not use park brake to slow windrower down. This will result in erratic machine reaction which could cause personal injury as well as damage to the brake mechanism.

2. Turn steering wheel until it locks.
3. Move throttle lever (B) to low idle position.

NOTE: Avoid unnecessary idling. Stop engine if it will be idling for longer than 5 minutes.

4. Move header drive switch (D) to off position to stop header drives.
5. Engage park brake (E) if machine is to remain stopped.



CAUTION: Park machine on flat level ground only. Keep park brake properly adjusted at all times. See Maintenance/Service section.

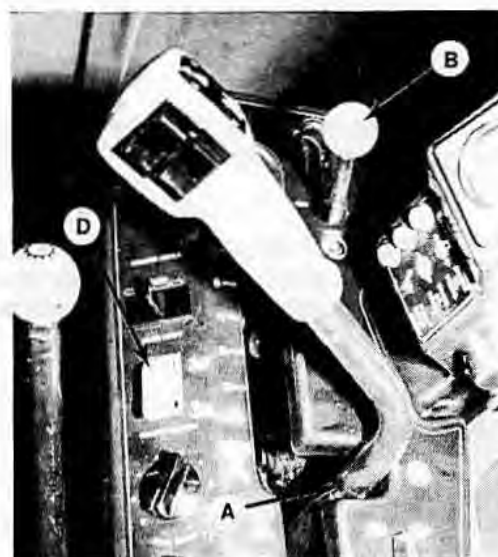

CONTROL LEVERS - STOPPING



ENGAGE PARK BRAKE

TO STOP ENGINE:



CAUTION: Be sure windrower is safely parked on a flat, level surface, header on the ground and the park brake engaged.

IMPORTANT: Before stopping engine, run at low idle for approximately five minutes to cool hot engine parts (and allow turbocharger, if applicable, to slow down while engine oil pressure is available).

1. Turn key counter-clockwise to OFF position (red marker).

IMPORTANT: Do not leave key in "ON" position, hour meter will keep running.

OPERATION

Leaving the Windrower



CAUTION: Before leaving the operator's seat for any reason:

1. Park on level ground if possible.
2. Be sure variable speed lever is in the neutral detent and steering wheel is locked in the straight ahead position.
3. Engage the park brake.
4. Fully lower header and reel.
5. Disengage header drives.
6. Stop engine and remove key from ignition. A child or even a pet could engage an idling machine.
7. Turn off all lights (and wiper).
8. Raise arm rest for easier exit and re-entry.
9. Lock the cab door when leaving the windrower unattended. (When the door is locked, it can still be opened from inside the cab.)
10. To provide more secure hand and foot mobility, preventing slipping and possible injury, always face the windrower and use the hand rail when dismounting (or mounting).

EMERGENCY EXIT

In case exit through cab door is not possible, the right hand side window may be opened to provide an emergency exit. Open window, then remove latch pivot pins (A) and push outward on window.

FOR NORMAL WINDOW OPERATION, open latches (B) and move window to open position.

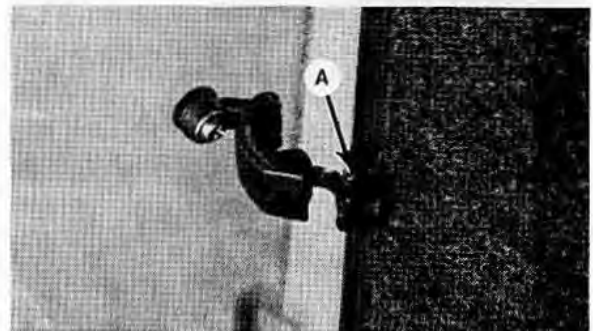
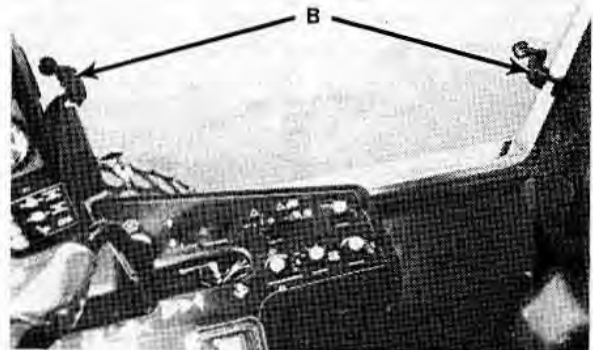

R/H SIDE WINDOW - EMERGENCY EXIT

OPERATION

Attaching the Header

NOTE: For Harvest Headers with gauge wheels, instructions under "Attaching" and "Detaching the Header" which refer to the "header stand" do not apply. Use the "stand" position of the gauge wheels to support rear of header. All gauge wheel positions are identified on a decal located at each gauge wheel. Be sure to reposition gauge wheel to field position before operating.

1. Choose an area that is as level as possible and set header stand (A) in the down position.

942 Header, set 2 inch (50 mm) blocks under each end of cutterbar.

960, 962 & 972 Headers, be sure header and tractor have been properly prepared for windrower use.

See "Preparing Tractor and Headers" in Assembly section for details.

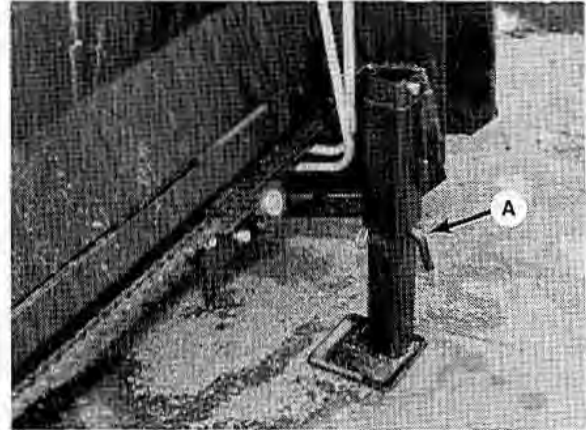

HEADER STAND - DOWN POSITION



CAUTION: Be sure area is clear of bystanders, then start engine.

2. Fully retract header lift cylinders.

NOTE: For Harvest Headers with Transport Option; when attaching to header in transport mode, position 6 inch high (150 mm) blocks for drive tires to provide adequate linkage height. Blocks should be at least the width of the drive tires and long enough that drive tires are fully supported when attaching header.

3. Slowly drive tractor forward so that lift linkage enters header legs. Continue to drive slowly forward until linkage contacts support plate in the lower header leg, and header nudges forward. Stop engine, set parking brake and remove key.

4. Adjust length of center link and connect to header at (C). For 962 and 972 headers, use the lower, more rearward hole in mount on header tube as shown.

NOTE: Ensure that thread length is equal at both ends of center link. See "Header Angle for adjustment details.

5. Check that bottom of linkage (D) is properly engaged in header leg, contacting support plate (E).

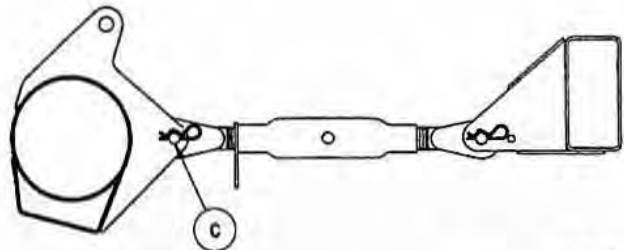

102995

INSTALL CENTER LINK

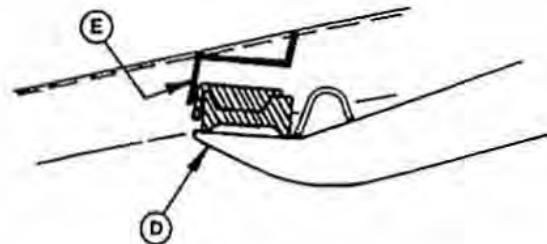

CHECK FOR PROPER ENGAGEMENT

OPERATION

Attaching the Header (continued)

6. Connect driveline to header drive shaft as follows:

Pull back spring loaded collar (G) on driveline yoke and slide yoke onto header shaft. Release collar, ensuring yoke locks in position on shaft.

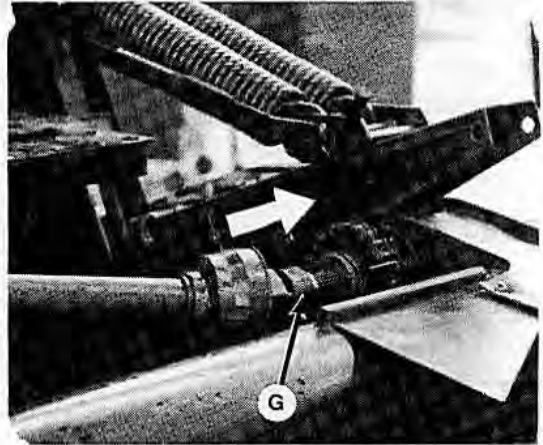

CONNECT DRIVELINE

7. Hydraulic Hose Connections:

920, 932 Headers: Two connections are made at couplers (A) and (B) at the header right hand leg. One connection is made at coupler (D) at the header left hand leg.

942, 960 & 970 Headers: Two connections are made at couplers (A) and (B) at the header right hand leg. Two connections are made at couplers (C) and (E) at the tractor left hand leg. One connection is made at coupler (D) at the header left hand leg.

- A - reel drive pressure
- B - reel drive return
- C - reel lift
- D - conveyor drive pressure
- E - conveyor drive return

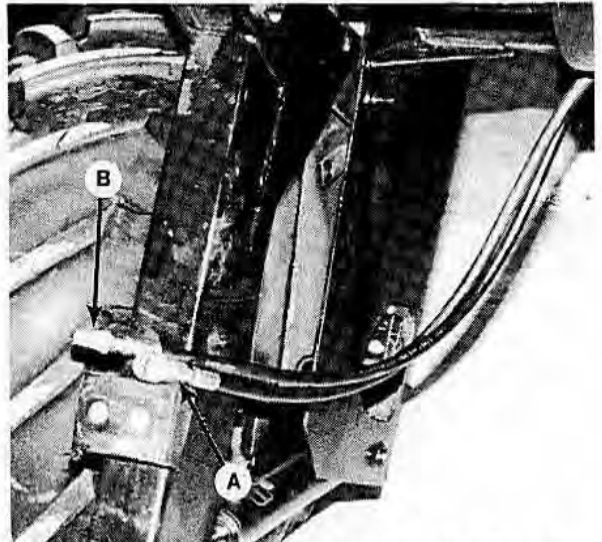

HYDRAULIC CONNECTIONS - R/H SIDE

8. Connect the header electrical wiring harness at connector (F).

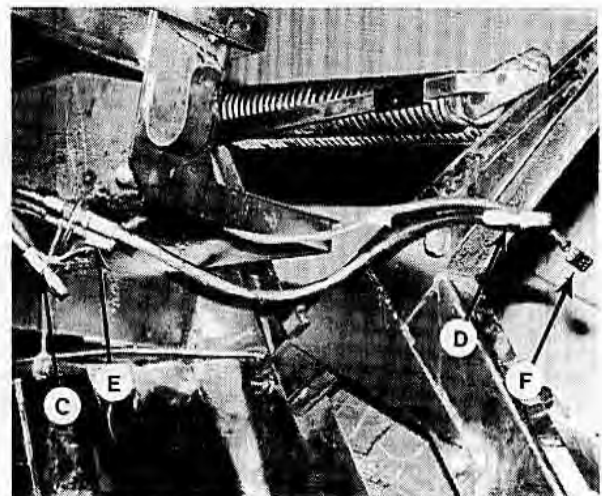

HYDRAULIC & ELECTRICAL CONNECTIONS
L/H SIDE

OPERATION

Attaching the Header (continued)

9. Start engine. Activate header lift cylinders (switch on ground speed lever) to raise header fully. Stop engine and remove key.

10.



DANGER: To avoid bodily injury from fall of raised header, always engage header lift cylinder stops (A) when working on or around raised header.

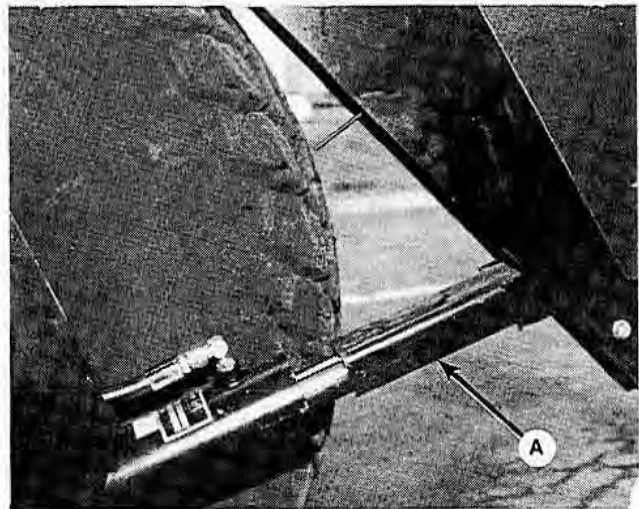

ENGAGE LIFT CYLINDER STOPS

11. Attach float springs to front of linkage, both sides. Secure with "L" pin (B) and hair pin.

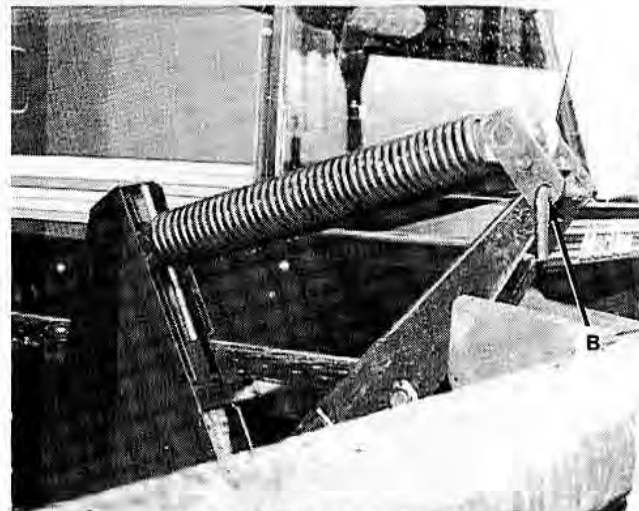

ATTACH FLOAT SPRINGS

12. Install pin (C) through header leg, (engaging U-bracket in lift linkage), both sides.

910, 920, 932 & 942 Headers: Secure L-pin behind lug (D).

960 Header: Rotate L-pin to align roll pin with key slot for installation and removal. Roll pin locks inside to secure the position.

962 Header: Secure 8" clevis pin with lynch pin.

970 Header: Secure 6½" clevis pin with lynch pin.

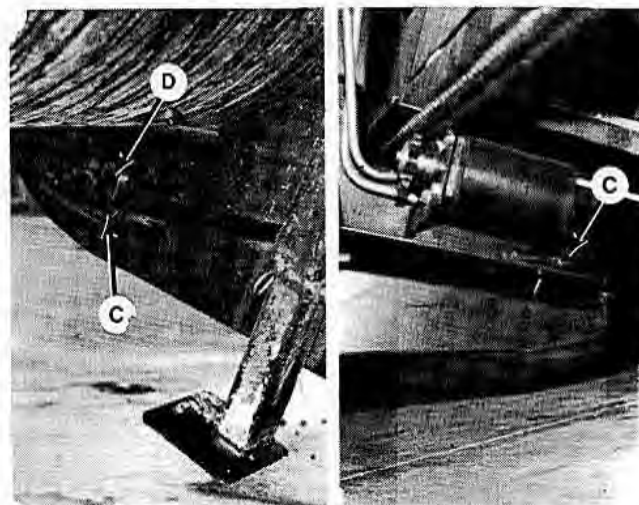

AUGER & MULTI-CROP DRAPER HEADER
INSTALL PINS THROUGH LEGS

OPERATION

Attaching the Header (continued)

13. Raise header stand to storage position (E).
14. Disengage header lift cylinder stops and lower header to ground. Check header flotation and adjust if required. See "Header Flotation" in Operation section (page 44).
15. For headers with hay conditioner, attach forming shield rear support straps to forming shields.

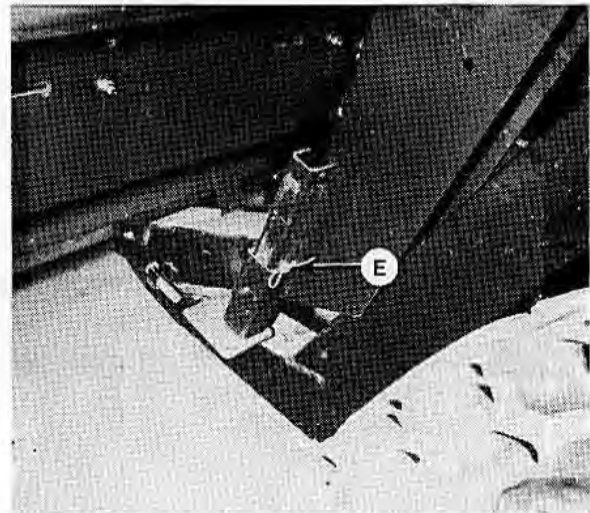

HEADER STAND - STORAGE POSITION

Adding Rear Weight

For heavier headers (3000 lbs. plus, including reel) in hilly conditions, weight may be added to the rear of the tractor frame. Weight packs are available from your Windrower dealer. One or two weight packs may be installed, as follows:

1. Install bolt (A) through welded nut in existing tractor weight (B) and start jam nut on bolt (A).
2. Insert weights (C) forward of welded pin (D) as shown, then move weight back towards rear of tractor.
3. After weights are in position, tighten bolt (A) against the new weight (C), then tighten jam nut against weight (B).

NOTE: Install complete weight pack on same side of pin (D). Total weight per pack is 187 lbs. (85 kg).

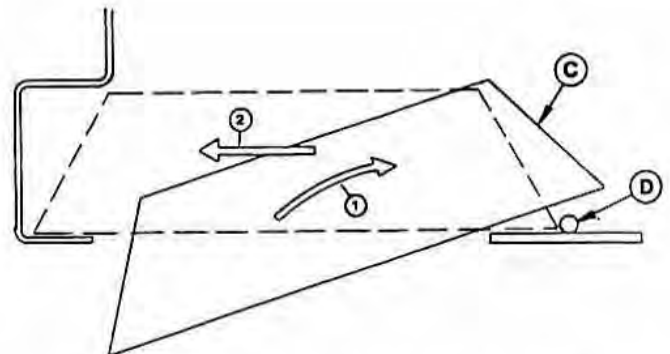

INSTALLATION OF WEIGHTS (REAR VIEW)

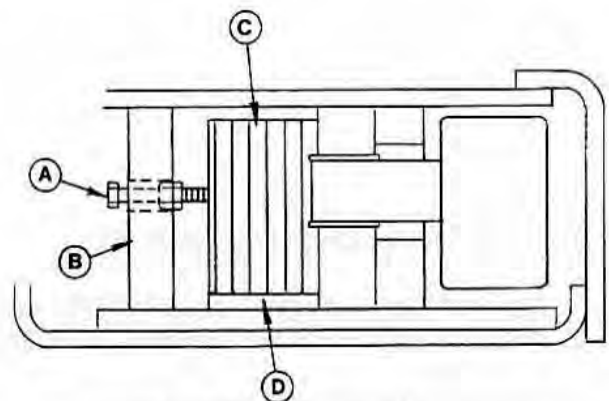

← direction of travel
OPTIONAL REAR WEIGHT PACK
(SIDE VIEW)

OPERATION

Detaching the Header

1. Activate header lift cylinders (switch on ground speed lever) to raise header fully. Lower the reel (second switch on lever). Stop engine and remove key.

2.



DANGER: To avoid bodily injury from fall of raised header, always engage header lift cylinder stops (A) when working on or around raised header.

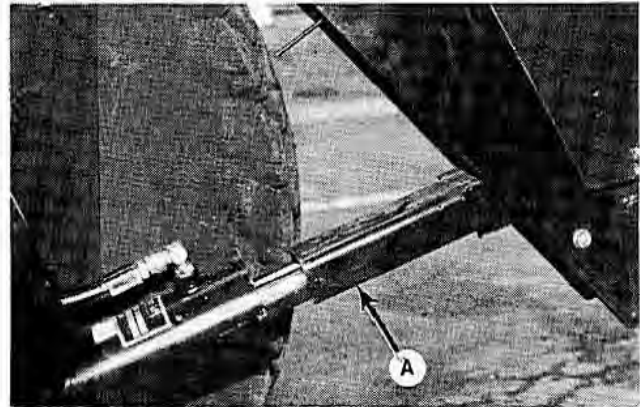

ENGAGE LIFT CYLINDER STOPS

3. Remove "L" pin (B), both sides and detach float springs.



DETACH FLOAT SPRINGS

4. Remove pin (C) from lower header leg, both sides.

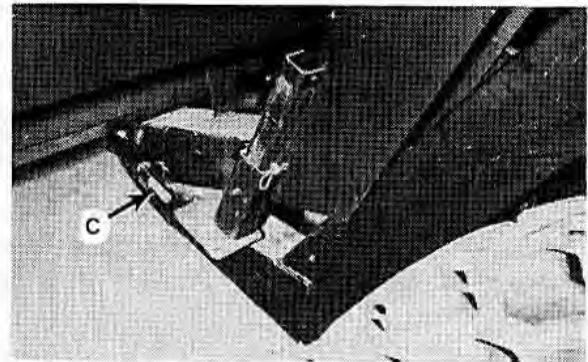

REMOVE HEADER PINS

5. Lower header stand into position (E).

942 Multi-Crop Header: Place 2 inch (50 mm) blocks under cutterbar at both ends of header.

6. Disengage header lift cylinder stops.
7. Be sure area is clear of bystanders, then start engine. Retract lift cylinders to fully lower header. Stop engine and remove key from ignition.

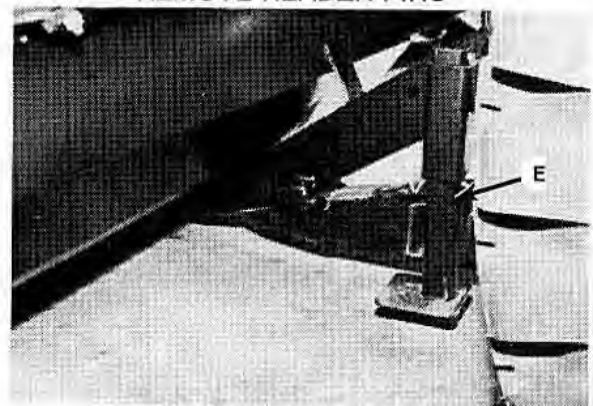

LOWER HEADER STAND

OPERATION

Detaching the Header (continued)

8.



DANGER: Wait for all movement to stop. A rotating driveline can cause entanglement resulting in serious personal injury or death.

Disconnect driveline from header shaft as follows: Pull back spring loaded collar on driveline yoke and remove yoke from header shaft.

Pull back spring loaded collar and store driveline on pin welded to tractor frame at (E).

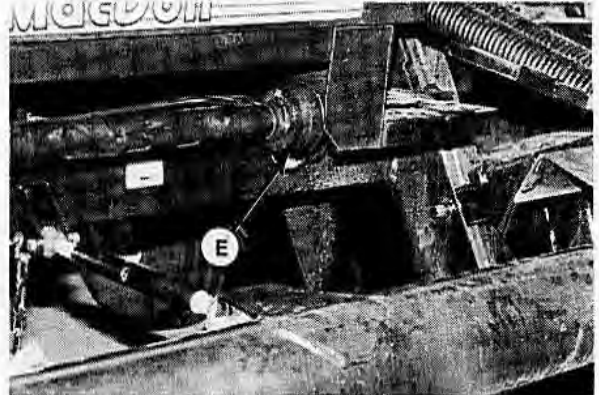

DETACH AND STORE DRIVELINE

9. Disconnect hydraulic hoses at quick couplers at right and left hand legs.

IMPORTANT: Where possible, connect hoses to each other for storage. Plug or cap all other couplers to prevent hydraulic system contamination. Store tractor reel drive hoses as shown at (G) to avoid interference during hook-up.

10. Disconnect electrical wiring harness.

NOTE: If a Hay Conditioner is installed, detach supports between tractor frame and conditioner forming shield.

11. Adjust length of center link to release load on pins. Disconnect center link at header by removing pin (F).
12. Slowly back tractor away from header. If hay conditioner is attached, watch clearances at left and right sides.

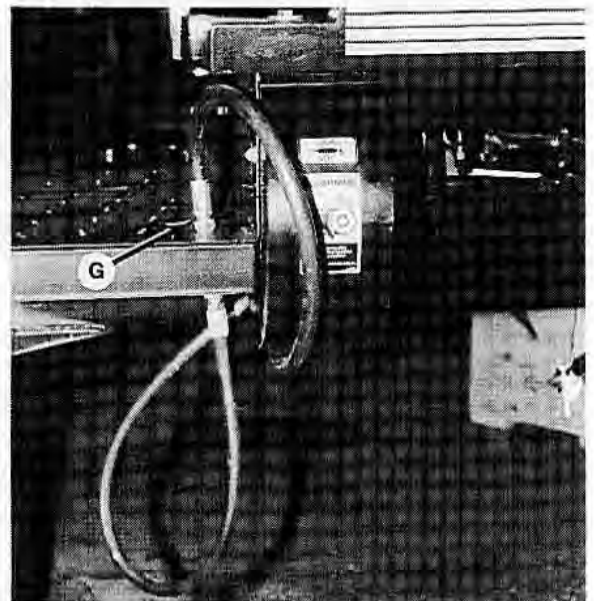

TRACTOR REEL DRIVE HOSES - STORAGE



WARNING: Avoid driving the tractor with header removed. Removing header decreases the weight on drive wheels, reducing steering control. If necessary to drive tractor with header removed, use transmission low speed range, do not exceed half maximum engine speed and avoid loose gravel and slopes.



WARNING: Harvest Header with Transport Option
This windrower tractor is not intended as a towing vehicle for the Harvest Header Transport configuration. If necessary to use the tractor in this manner, add a minimum 2000 lb. (910 kg) counterweight on the lift linkage.

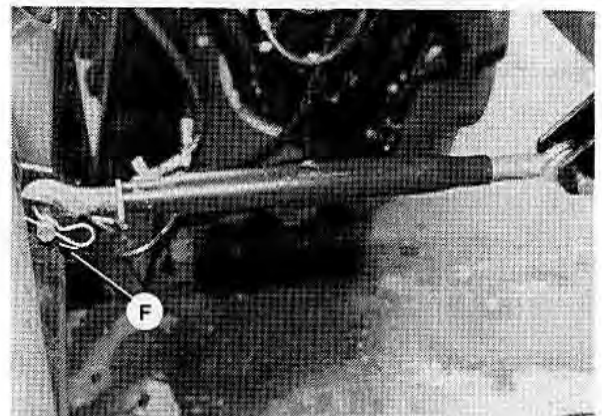

DETACH CENTER LINK AT HEADER

OPERATION

Operating the Header

Correct operation reduces crop loss and allows cutting of more acres. The length of service you receive from your windrower depends upon thorough lubrication, and proper maintenance and adjustments.



CAUTION: Do not mount anything on the windrower tractor except the headers designed for use with it. Unapproved attachments may change the stability and controllability of the machine.

Header Lift Cylinder Stops



DANGER: To avoid bodily injury or death from fall of raised header, always engage cylinder stops before going under header for any reason.

Cylinder stops are located on both header lift cylinders on windrower.

To engage cylinder stops:

1. Press top of header height switch (A) to raise header to maximum height.
2. Lift retainer (B) up to release cylinder stop (C). Lower stop onto cylinder.
3. To store, push up on stop (C) until retainer locks in storage position.



HEADER HEIGHT SWITCH

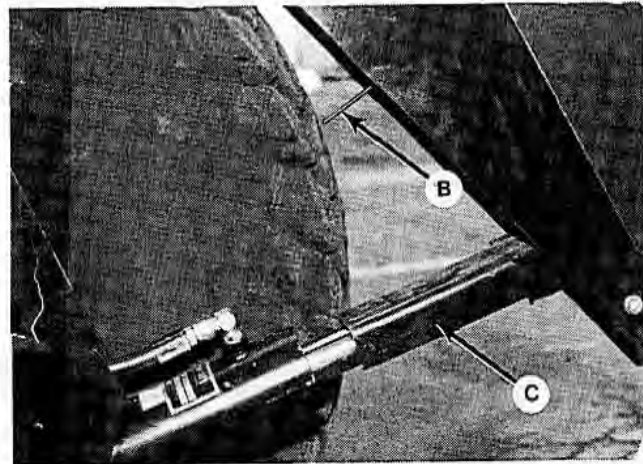

LIFT CYLINDER STOP - ENGAGED

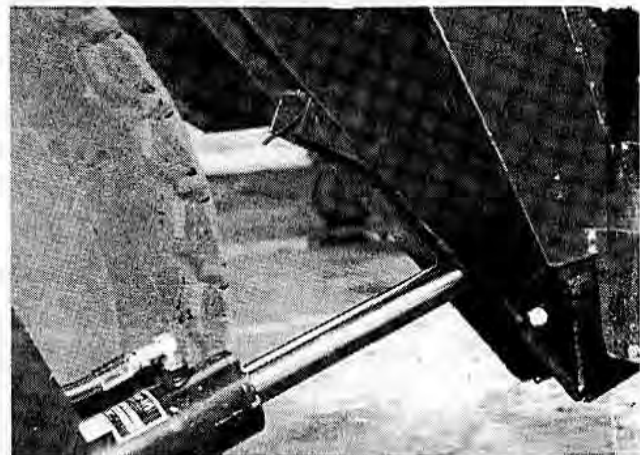

LIFT CYLINDER STOP - STORAGE

OPERATION

Header Angle

Header angle is adjustable by changing the length of the center link between header and tractor.

Header angle adjustment ranges:

910, 920, 932 Headers: 8° to 16°

942 Header: 6° to 13°

960, 962 Header: 13° to 21°

972 Header: 9.5° to 21°

NOTE: Above figures are guard angle in degrees below horizontal.

IMPORTANT: A flatter header angle is recommended for normal conditions. A flatter angle reduces sickle section breakage and reduces soil build-up at the cutterbar in wet conditions.

Use a steeper angle to cut very close to the ground, or for better lifting action of down crops.

To adjust header angle:

1. Unlock collar (C) by tapping it in a counter-clockwise direction.
2. Using a long punch in hole (D), turn the center link until the desired header angle is reached. Shortening the link will give a flatter header angle, while lengthening the link provides steeper angles.
3. Lock collar (C) against link body by tapping in a clockwise direction to secure the position.

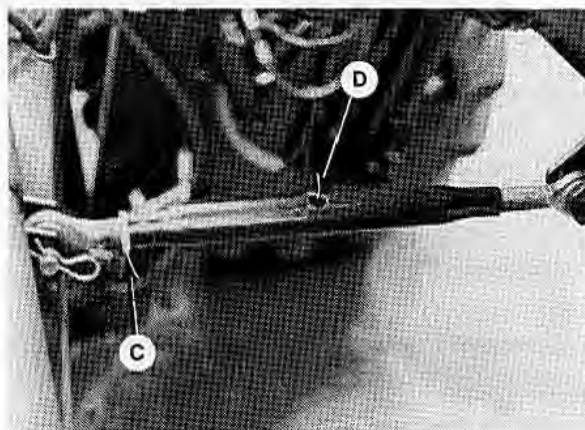

HEADER ANGLE ADJUSTMENT

To adjust header angle when cutting on the ground:

When cutting with header on the ground, the header height switch can be used to adjust header angle "on the go". Familiarize yourself with how the header reacts during this adjustment to take full advantage of the feature.

1. Lower header by pressing bottom of header height switch until cutterbar just touches ground. At this point, cutterbar is at the flattest guard angle.
2. If a steeper angle is desired, continue pressing bottom of switch. This will steepen the guard angle until lift cylinders are fully retracted.
3. To adjust angle from steeper to flatter, press the top of the header height switch to extend cylinders a small amount. Once the flattest angle is reached, further activating the switch will lift the cutterbar off the ground.

Use this adjustment in combination with the center link adjustment (above) to achieve the desired range through which the header angle moves before header lifts off the ground.

See "Header Controls" in Operator's Station section for use of header height switch and cut height indicator with regard to header angle.

OPERATION

Header Levelling

A 1/4 inch (6 mm) shim (A) is located on both sides of windrower lift linkage. If header is not level, adjust as follows:

1. Lower header onto a block so back of linkage lifts.
2. Remove hardware (B) on the high side of the header and remove shim (A). Replace hardware (B).
3. Check header level. If more levelling is required, install the removed shim on opposite side of linkage, adding it to the existing shim.
4. If header is still not level, additional shims are available from your dealer.

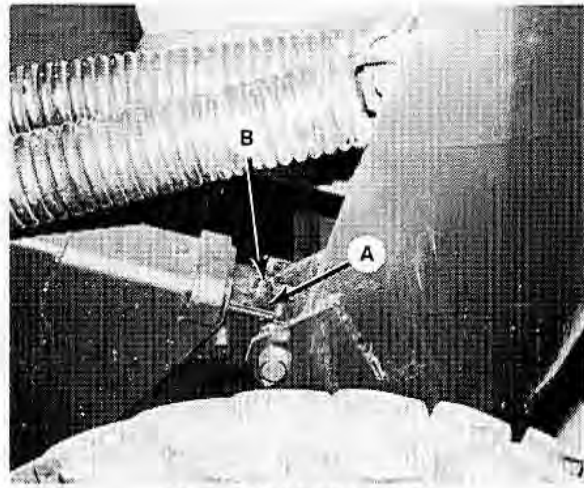

HEADER LEVELLING

Header Flotation

The following suggested header float settings are a starting point for normal conditions. Your specific requirements and conditions may require heavier or lighter float.

Force required to lift the cutterbar off ground at each end of the header (with lift cylinders fully retracted):

910/920/932 Auger Headers:	100 to 120 lbs. (445 - 535 N)
942 Multi-Crop Header:	75 to 100 lbs. (335 - 445 N)
960/962/970 Headers:	50 to 75 lbs. (225 - 335 N)

Benefits of lighter float settings:

1. Less cutting component breakage in rough or stony conditions.
2. Avoids soil build-up at cutterbar in wet conditions.

Benefits of heavier float settings:

1. When cutting very close to the ground, enables the cutterbar to follow ground contours.

See the following charts for approximate drawbolt settings for normal conditions for the different header types. Note that because of end-to-end weight differential, left and right drawbolt settings are different.

* Dimensions given in charts are for Auger and Multi-Crop Headers without hay conditioner, and 960/962 Harvest Header with standard bat reel. For Auger or Multi-Crop Headers with hay conditioner, or 960/962 Harvest Header with pick-up reel, decrease dimension (A) by 1 inch (25 mm).

NOTE: For heavier headers, e.g. 36' 972 and 16' 920, an auxiliary float spring kit is available which consists of an inner spring installed inside one of the main springs on the heavy side. Kit number is B2773.

OPERATION

Header Flotation (cont'd.)

AUGER HEADER	DIMENSION (A)*	
	LEFT SIDE	RIGHT SIDE
12'	5" (125 mm)	8" (200 mm)
14'	4" (100 mm)	7" (175 mm)
16'	3" (80 mm)	6" (150 mm)

910/920/932 AUGER HEADERS
NORMAL DRAWBOLT SETTINGS

960/962 HARVEST HEADER	DIMENSION (A)*	
	LEFT SIDE	RIGHT SIDE
21'	8" (200 mm)	7" (175 mm)
25'	6" (150 mm)	6" (150 mm)
30'	4" (100 mm)	5" (125 mm)
36'	2.5" (65 mm)	4" (100 mm)

960/962 HARVEST HEADER
NORMAL DRAWBOLT SETTINGS

MULTI- CROP HEADER	DIMENSION (A)*	
	LEFT SIDE	RIGHT SIDE
12'	8" (200 mm)	9" (225 mm)
15'	7" (175 mm)	8" (200 mm)
18'	6" (150 mm)	7" (175 mm)

942 MULTI-CROP HEADERS
NORMAL DRAWBOLT SETTINGS

972 HEADER	DIMENSION (A)*	
	LEFT SIDE	RIGHT SIDE
15'	6" (150 mm)	10" (250mm)
18'	5" (125 mm)	9" (225 mm)
21'	4" (100 mm)	8" (200 mm)
25'	3" (75 mm)	7" (175 mm)
30' *	5.1" (130 mm)	3.7" (95 mm)
36' *	3.5" (90 mm)	5" (125 mm)

* - with gauge wheels

972 HEADER
NORMAL DRAWBOLT SETTINGS

To adjust header float:

1. Raise header fully, shut off engine and remove key.
2. Loosen nut (C).
3. Turn spring drawbolt (B) clockwise to increase float (which makes header lighter when lowered to ground).

Turn bolt counter-clockwise to decrease float (which makes header heavier when lowered).

4. Tighten nut (C) to lock position.
5. Lower header fully and check float at both ends of cutterbar. Force required to lift cutterbar should be approximately the same at both ends.

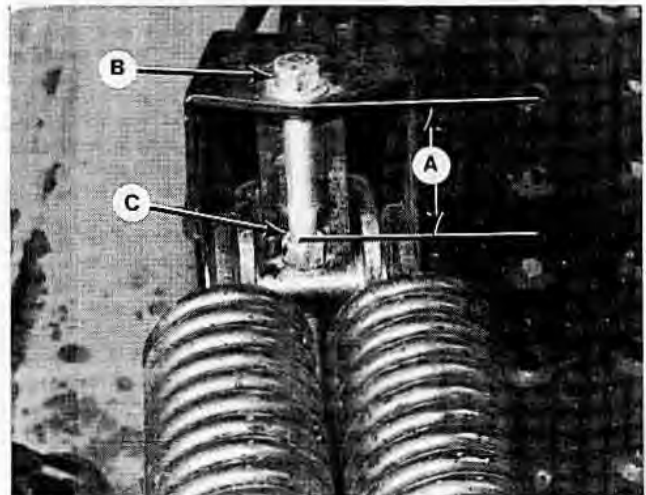

FLOAT ADJUSTMENT

OPERATION

Transporting the Windrower



WARNING: Do not drive windrower on a road or highway at night, or in conditions which reduce visibility, such as fog or rain. The width of the windrower may not be apparent under these conditions.



WARNING: Avoid driving the tractor with header removed. Removing header decreases the weight on drive wheels, reducing steering control. If necessary to drive tractor with header removed, use transmission low speed range, do not exceed half maximum engine speed and avoid loose gravel and slopes.



WARNING: Harvest Header with Transport Option

This windrower tractor may be used to tow 21' & 25' harvest headers when a MacDon approved towing package and weight box are used.

Do not use this windrower tractor to tow 30', 36' or 39' harvest headers. Instead, refer to the 30/36/39' header manuals for instructions on towing these headers.



CAUTION:

1. Check local laws for width regulations and lighting or marking requirements before transporting on roads.

2. Move header drive switch (A) to off position.
3. For road speeds, move speed-range control (C) to road position (handle forward). Remember steering is more sensitive in this speed range.
4. Before driving windrower on a roadway, be sure flashing amber lamps, red tail lamp and head lamps are clean and work properly. Turn light switch (B) to ROAD position to activate these lamps. Always use these lamps on roads to provide warning to other vehicles.
5. Do not use field lamps on roads, other drivers may be confused by them.
6. Before driving windrower on roadway, clean all reflective surfaces and slow moving vehicle emblem at rear of machine. Adjust rear view mirror and clean windows.



HEADER DRIVE SWITCH OFF & SPEED-RANGE CONTROL TO "ROAD"

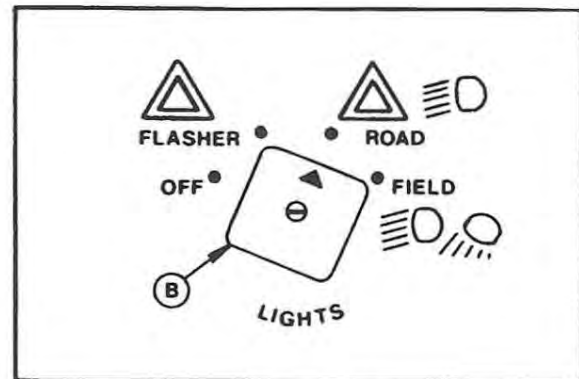

LIGHT SWITCH TO "ROAD" POSITION

7. Transport windrower with header fully raised and reel fully lowered. Maintain adequate visibility and be aware of roadside obstructions, oncoming traffic and bridges.
8. When travelling down hill, reduce speed and keep header at a minimum height. This provides maximum stability if forward motion is stopped for any reason. Raise header completely at bottom of grade to avoid contacting ground.
9. Travel speed should be such that complete control and machine stability are maintained at all times.
10. Stop, look and listen before entering a roadway. Stay on correct side of the road and pull over if possible to let faster traffic pass. Slow down and signal as you turn off.

OPERATION

Transporting the Windrower

TOWING THE WINDROWER ON A TRAILER

For transporting the windrower other than under its own power, a side mount trailer (A) carrying all four windrower wheels is recommended.

Also acceptable are side mount trailers (B) where the windrower tail wheels remain on the ground. For this type, tighten caster set screws, step 7, below.

For narrower headers, front or rear mount trailers may be used, providing local laws regarding width regulations are adhered to.

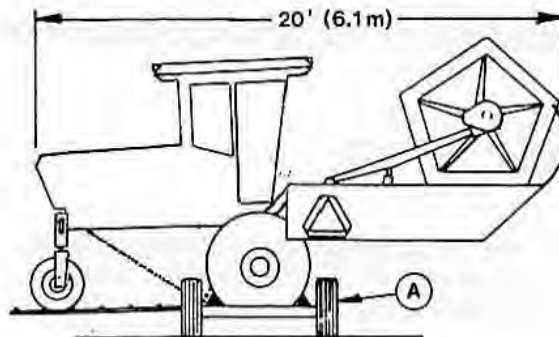

SIDE MOUNT TRAILER - TYPE (A)

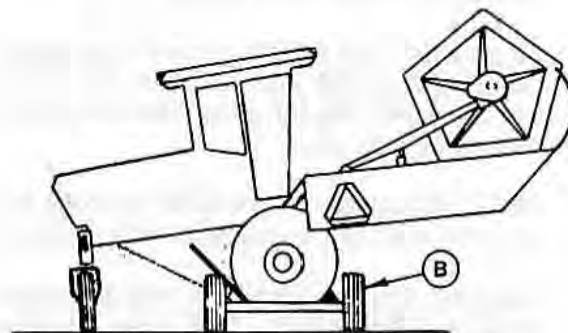

SIDE MOUNT TRAILER - TYPE (B)



WARNING: When towing the windrower on a trailer:

1. Keep header fully raised and reel fully lowered.
2. Chain windrower securely to trailer. Run chains through triangular brackets (C) at rear of tractor frame legs and through anchor (D) at rear of frame. Be sure windrower weight is centered on trailer for stable load. Block drive wheels to prevent movement.
3. Transport width is approximately 20 ft. (6.1 m). Check local laws for width regulations and lighting or marking requirements.
4. Remember that when towing windrower sideways or backwards, slow moving vehicle emblem, reflectors and warning lights are not easily visible. It is your responsibility to adequately mark the load when transporting in this fashion.
5. Set light switch to FLASHER position to activate amber lamps.
6. Do not tow the windrower on a roadway at night, or in conditions which reduce visibility, such as fog or rain. The width of the load makes it unsafe to transport under these conditions.
7. If towing at speeds over 16 mph (26 km/h), on a type (B) trailer:
 - a) Align caster wheels with trailer wheels.
 - b) Tighten caster set screws (E) to 20 ft. lbs. (27 N.m) to prevent erratic movement of the casters. Failure to do this will result in caster damage and could cause loss of control.
 - c) Loosen set screws after transport.

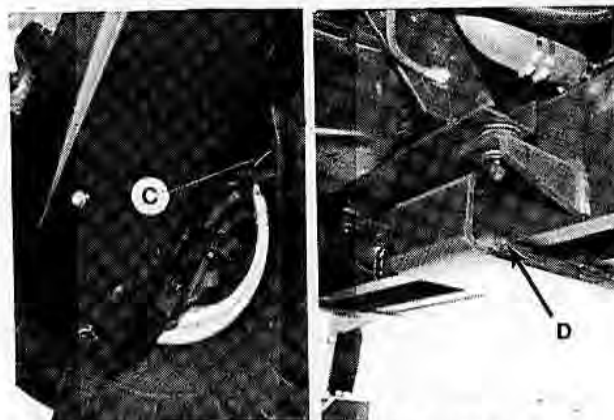

CHAIN WINDROWER TO TRAILER

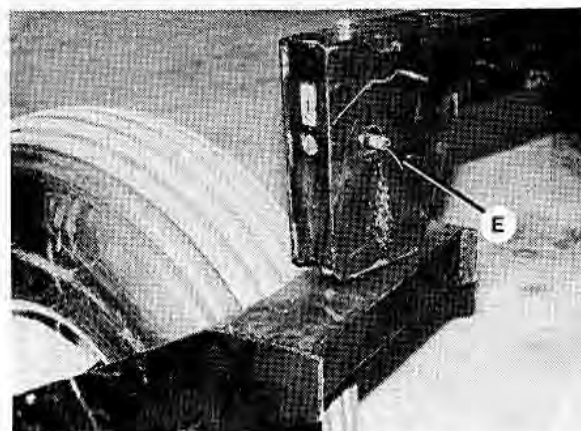

CASTER SET SCREWS

OPERATION

Transporting the Windrower

TOWING THE WINDROWER ON A TRAILER (continued)



WARNING:

8. Do not tow at speeds over 25 mph (40 km/h). Travel speed should be such that complete control and stability are maintained at all times.
9. Be aware of roadside obstructions, oncoming traffic and bridges. Take care when travelling over rough terrain or on slopes.
10. Be sure the total weight of the trailed vehicle **NEVER EXCEEDS** the weight of the towing vehicle, unless the trailed vehicle is equipped with remote brakes.

NOTE: Windrower weighs 8000 to 10000 lbs. (3600 to 4500 kg) depending on header size.

Stopping distance increases with increasing speed as the weight of the trailed vehicle increases, especially on hills and slopes.

11. **IMPORTANT:** Before towing, plug or cover muffler exhaust to prevent the turbine from turning without lubrication. This "free-wheeling" of the turbocharger can cause damage.

OPERATION

Transporting the Windrower

TOWING WINDROWER WITHOUT TRAILER

The best method for transporting a disabled windrower is to haul it on a suitable trailer or flatbed. (See Towing Windrower on a Trailer.)

In emergency situations, for example, towing out of a field or into a shop, windrower may be towed without a trailer, providing the following precautions are followed:

1. Attach windrower to towing vehicle.



WARNING: A proper towing apparatus is critical to safe towing. Use the following guidelines:

- Do not attach directly from hitch to walking beam (B). Slope of tow bar will not provide proper transfer of braking force to windrower, causing loss of control.
- For proper steering, towing apparatus should be attached to both left and right hand frame members (C) and should attach to tow bar at same height (D) as towing vehicle hitch.
- Towing apparatus should be removed for field operation, to avoid interference with windrow.



CAUTION: With final drives disengaged, the windrower may roll on a sloped surface. Before disengaging final drives, attach windrower to towing vehicle.

After towing, engage drives and park brake before detaching from towing vehicle.

2. Disengage final drives:
 - Remove cover (A) at center of drive wheels.
 - Replace with dished side facing in.

IMPORTANT: Failure to disengage final drives before towing will result in serious transmission damage.

After towing, reverse cover (A) to re-engage final drives. Be sure plunger at center of wheel pops out to engage drive.

3. Do not exceed 16 mph (26 km/h) when towing windrower. Do not use this towing method for normal transporting of windrower. Even with final drives disengaged, rolling speeds of more than 16 mph (26 km/h) will cause final drive gears to run at excessive speeds, possibly destroying the unit.

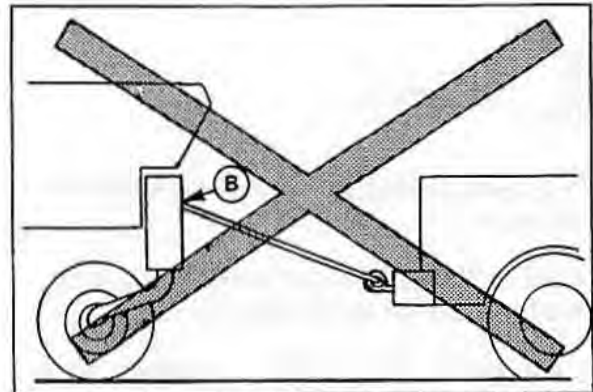

DO NOT ATTACH TO WALKING BEAM

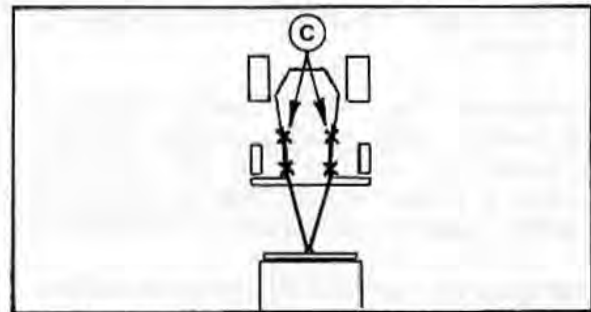

ATTACH TOWING APPARATUS TO FRAME

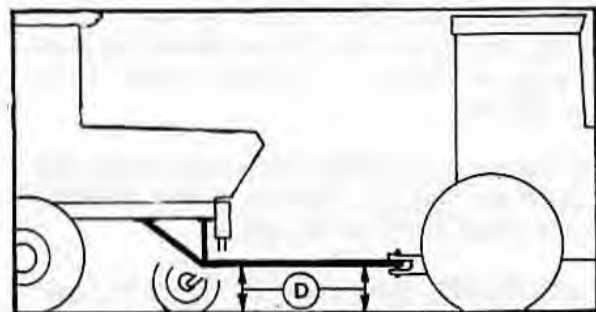

TOW BAR PARALLEL TO GROUND

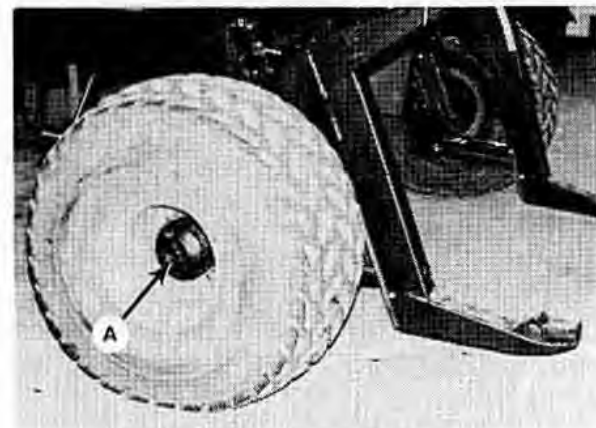

DISENGAGE FINAL DRIVES

OPERATION

Transporting the Windrower

TOWING WINDROWER WITHOUT TRAILER

(continued)

4.



WARNING:

- Be sure the towing vehicle is heavier than the windrower.

NOTE: Windrower weighs 8000 to 10000 lbs. (3600 to 4500 kg) depending on header size.

Remember stopping distance increases when towing, especially on hills and slopes.

- Do not exceed 16 mph (26 km/h) when towing windrower.
 - Remember that when towing windrower backwards, slow moving vehicle emblem, reflectors and warning lights are not easily visible. It is your responsibility to adequately mark the load when transporting in this fashion.
 - Set light switch to FLASHER position to activate amber lamps.
 - Do not tow the windrower on a roadway at night, or in conditions which reduce visibility, such as fog or rain. The width of the load makes it unsafe to transport under these conditions.
 - Be aware of roadside obstructions, oncoming traffic and bridges. Take care when travelling over rough terrain or on slopes.
5. **IMPORTANT:** Before towing, plug or cover muffler exhaust to prevent the turbine from turning without lubrication. This "free-wheeling" of the turbocharger can cause damage.

OPERATION

Storage Procedure

Do the following at the end of each operating season:



CAUTION:

1. **Clean the windrower thoroughly. Never use gasoline, naphtha or any volatile material for cleaning purposes. These materials may be toxic and/or flammable.**
2. **Store windrower in a dry protected place. Never operate engine in a closed building. Proper ventilation is required to avoid exhaust gas hazards.**
3. **Remove the battery. Bring to full charge and store in a cool, dry place not subject to freezing. Remember when working around storage batteries that all of the exposed metal parts are "live". Never lay a metal object across the terminals because a spark and short circuit will result.**
4. **Cover cutterbar and knife guards to prevent injury from accidental contact.**

Also:

5. If stored outside, always cover windrower with a waterproof tarpaulin or other protective material. This will protect the switches, instruments, tires, etc. from inclement weather. If no cover is available; seal air cleaner intake and exhaust pipe with plastic bags and/or waterproof tape.
6. If possible, block up windrower to take weight off tires. If it is not possible to block up the machine, increase tire pressure by 25% for storage. Adjust to recommended pressure before next use.
7. Repaint all worn or chipped painted surfaces to prevent rust.
8. Lubricate the windrower thoroughly, leaving excess grease on fittings to keep moisture out of bearings. Apply grease to exposed threads and sliding surfaces of components.
9. Check for worn components and repair. Tighten loose hardware and replace any missing hardware. See Specifications section for torque charts.
10. Check for broken components and order replacements from your dealer. Attention to these items right away will save time and effort at beginning of next season.
11. Add rust inhibitor to the engine oil.
Diesel Engine - use 10 oz (300 ml)
Run engine to operating temperature to mix inhibitor with oil.
12. To prevent condensation, fill hydraulic oil reservoir to filler neck with approved hydraulic system oil. See "Fuels, Fluids and Lubricants" in Maintenance/Service section.
13. Test engine coolant anti-freeze concentration to ensure it is sufficient to protect engine against lowest expected temperature.

MAINTENANCE/SERVICE

Service Procedures



CAUTION: To avoid personal injury, before servicing machine or opening drive covers:

1. Fully lower header and reel.
2. Disengage header drive clutch.
3. Stop engine and remove key.
4. Engage park brake.
5. Wait for all moving parts to stop.

Wear close-fitting clothing and cover long hair. Never wear dangling items such as scarves or bracelets.

Wear protective shoes with slip-resistant soles, a hard hat, protective glasses or goggles and heavy gloves.

Be prepared if an accident should occur. Know where the first aid kit and fire extinguisher are located and how to use them.

Keep the service area clean and dry. Wet or oily floors are slippery. Wet spots can be dangerous when working with electrical equipment. Be sure all electrical outlets and tools are properly grounded.

Use adequate light for the job at hand.

Park on level surface when possible. Block wheels securely.

Replace all shields removed or opened for service.

Use only service and repair parts made or approved by the equipment manufacturer. Substituted parts may not meet strength, design or safety requirements.

Keep the windrower clean. Do not allow oil or grease to accumulate on the service platform, ladder or controls.

Never use gasoline, naphtha or any volatile material for cleaning purposes. These materials may be toxic and/or flammable.



**STAY CLEAR OF DRIVELINE
AND ALL MOVING PARTS**

MAINTENANCE/SERVICE

Fuels, Fluids and Lubricants

DIESEL FUEL

Use Grade No. 2 - D fuel, as defined by ASTM Designation: D 975 for diesel fuels.

NOTE: When temperature is very cold, the use of a mixture of No. 1 and No. 2 Diesel Fuel is permitted for a short period of time, providing the following specifications are met:

Sulphur Content - less than 1% by weight, preferably less than .5%.

Water and Sediment - for maximum filter life, should not exceed .1% by weight.

Cetane Number - 40 minimum. In cold weather or high-altitude operation, a higher cetane number (45 to 55) is desirable.

Diesel Fuel Conditioner is available from your dealer. The use of diesel fuel conditioner will:

1. Clean fuel injectors, valves and manifolds for increased service life.
 2. Disperse insoluble gummy deposits that can form in the fuel system.
 3. Separate moisture from the fuel.
 4. Stabilize fuel in storage.
-

ENGINE COOLANT

Use a 50/50 mix of water and anti-freeze.

Anti-freeze Specification: Ethylene-glycol or propylene-glycol fully formulated, containing a pre-charge supplemental coolant additive (SCA) and meeting ASTM Designation: D 4985.

GREASE

Use an SAE Multi-Purpose High Temperature Grease with Extreme Pressure (EP) Performance and containing 1.5% to 3% molybdenum disulphide.

Also acceptable is an SAE Multi-Purpose Lithium Base Grease.

MAINTENANCE/SERVICE

Fuels, Fluids and Lubricants (continued)

HYDRAULIC OIL

SAE 10W30 complying with SAE specs for API Class SF or CC engine oil.

ENGINE OIL

SAE 15W40 complying with SAE specs for API Class SJ and CH-4 engine oil.

BEVEL GEAR BOX LUBRICANT

Use SAE 85W-140 gear lubricant. (API Service Classification GL-5)

POWER WHEEL GEAR LUBRICANT

Use ISO VG220 synthetic gear lubricant.

STORING LUBRICANTS

IMPORTANT: Your machine can operate at top efficiency only if clean lubricants are used. Use clean containers to handle all lubricants. Store them in an area protected from dust, moisture and other contaminants.

MAINTENANCE/SERVICE

Fuels, Fluids and Lubricants (continued)

SYSTEM CAPACITIES

	<u>S.I.</u>	<u>U.S.</u>
Fuel Tank	193 L	51 gal.
Hydraulic System: Total (varies with options) Reservoir Capacity	65 L (approx.) 54 L	17 gal. (approx.) 14.4 gal.
Bevel Gear Box	1 L	1 qt.
Power Wheel	1350 mL	45 oz.
Engine Cooling System: Diesel	18 L	4.8 gal.
Diesel Engine Crankcase: Less Filter With Filter	9.5 L 10.4 L	10 qts. 11 qts.
Air Conditioning System: Refrigerant (R134a) Oil (SP-20 PAG)	1.36 kg 240 cc*	3 lbs. 8.1 fl.oz.*

* - This amount of oil is the full system requirement and is included in a new compressor.

Greasing the Windrower Tractor

See "Fuels, Fluids and Lubricants" for recommended greases.

The following greasing points are marked on the windrower by decals showing a grease gun (A), and grease interval (B) in hours of operation. Use the hour meter in the cab and the "Maintenance Checklist" provided to keep a record of scheduled maintenance.

Procedure:

1. Wipe grease fitting with a clean cloth before greasing, to avoid injecting dirt and grit.
2. Inject grease through fitting with grease gun until grease overflows. Inject grease slowly to prevent seal damage.
3. Leave excess grease on fitting to keep out dirt.
4. Replace any loose or broken fittings immediately.
5. If fitting will not take grease, remove and clean thoroughly. Also clean lubricant passageway. Replace fitting if necessary.

10 Hours



DANGER: Stay clear of driveline until all movement has stopped. Entanglement with rotating driveline will cause serious personal injury or death. Avoid loose fitting or dangling clothing.

NOTE: For Harvest Header, there are two more 10 Hour fittings on driveline connector shaft.

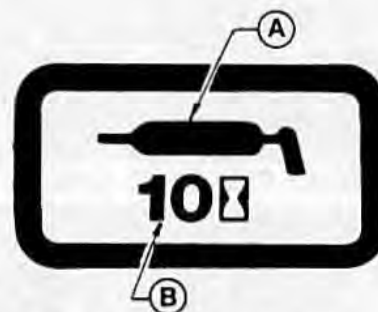

SAMPLE GREASE DECAL



STAY CLEAR OF ROTATING DRIVELINES

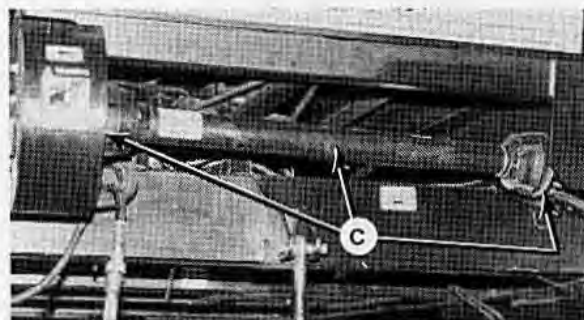

DRIVELINE (C) - THREE FITTINGS

MAINTENANCE/SERVICE

Diesel Engine

LUBRICATING OIL

Check engine oil level daily on dipstick.

See "Fuels, Fluids and Lubricants" section for recommended oil type.

IMPORTANT: Never operate the engine with the oil level below the "L" (LOW) mark or above the "H" (HIGH) mark.

CAPACITY - LOW MARK TO HIGH: 1 U.S. qt. (1 litre)

Change engine oil and filter after the FIRST 25 HOURS OF OPERATION and every 200 hours (or beginning of each operating season) thereafter.

To change:

1. Warm up the engine. Shut engine off and remove ignition key.
2. Remove the drain plug (A) and allow oil to drain.



CAUTION: Remember that the oil is hot.

NOTE: A drain pan with a capacity of 5 U.S. gallons (20 litres) will be adequate.

3. Check the condition of the used oil:
 - Thin, black oil indicates fuel dilution.
 - Milky discolouration indicates coolant dilution.

If oil appears diluted, have your Dealer correct the problem before operating the windrower.

4. Clean around the filter head, remove the filter and clean the gasket surface.
5. Apply a thin film of clean oil to the gasket on the new filter.

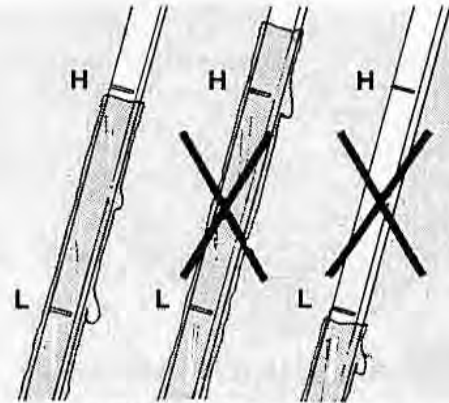

MAINTAIN ENGINE OIL LEVEL

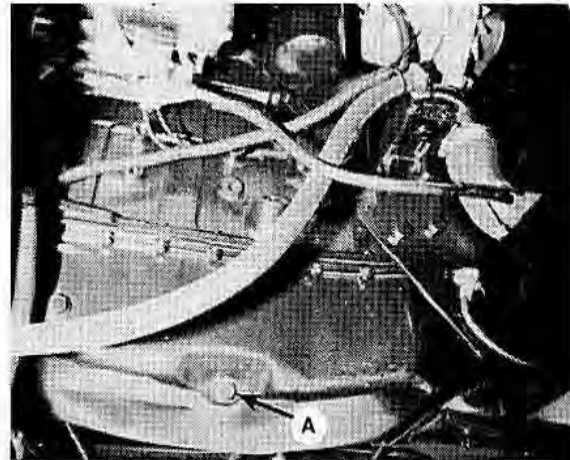

REMOVE DRAIN PLUG



OIL FILTER - DIESEL ENGINE

MAINTENANCE/SERVICE

Diesel Engine

LUBRICATING OIL

Changing engine oil and filter (continued)

6. Install the new filter. Turn the filter onto the mount until the gasket contacts the filter head. Tighten the filter an additional 1/2 to 3/4 turn by hand.

IMPORTANT: Do not use a filter wrench to install the oil filter. Over-tightening can damage the gasket and the filter.

7. Install the oil pan drain plug.
8. Fill the engine at (A) with the proper amount of oil. See "Fuels, Fluids and Lubricants" section for recommended oil types.

Capacity	Diesel Engine
With filter change	11 US qts (10.4L)
Without filter change	10 US qts (9.5L)

9. Operate the engine at low idle and check for leaks at the filter and drain plug.
10. Shut off engine. Wait five minutes, then check oil level at dipstick. If required, add or drain oil to bring level to high mark.

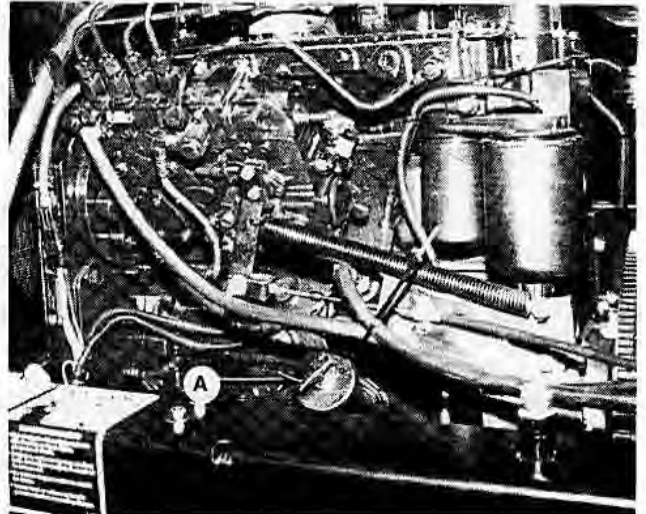

FILLER LOCATION - DIESEL ENGINE
(view from right side of windrower)

DIESEL ENGINE BELTS

The alternator/water pump/fan belt is automatically tightened. No manual adjustment is required. See installation procedure at right.

NOTE: When installing new compressor belt (G), never pry belt over pulley. Loosen necessary hardware and adjust belt tension. Re-adjust tension of a new belt after a short run-in period. (About 5 hours.)

To adjust compressor belt:

1. Loosen compressor mounting hardware.
2. Adjust tension so that a force of 8 to 12 lbs. (35 to 55 N) deflects belt 3/16 inch (5 mm) at mid-span.
3. Tighten compressor mounting hardware and recheck tension.

- A - Air Conditioning Compressor
- B - Alternator
- C - Water Pump
- D - Fan Pulley
- E - Crankshaft Pulley
- F - Automatic Belt Tightener
- G - Compressor Belt
- H - Alternator/Water Pump/Fan Belt

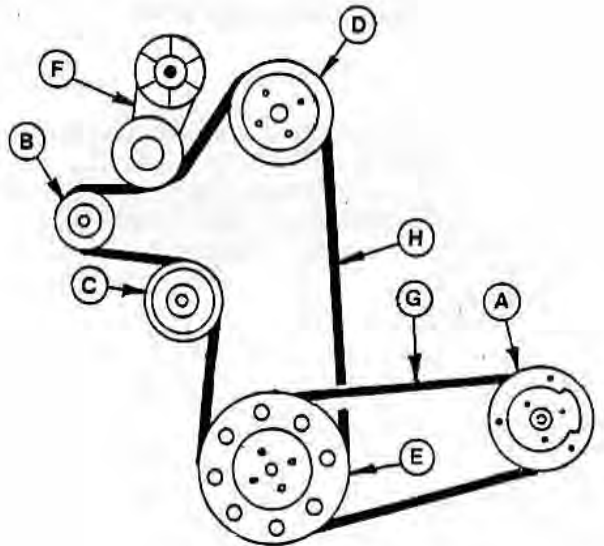

BELTS - DIESEL ENGINE

MAINTENANCE/SERVICE

Diesel Engine (continued)

ENGINE SPEED:

Engine maximum and low idle speeds are factory set to specifications listed on page 12.

IMPORTANT: Do not remove any seals from injector pump; removal of seals will void engine warranty. If specified speeds can not be maintained, see your Windrower dealer.

NON-TURBO ENGINE

MAXIMUM SPEED SETTING

For the non-turbo engine, if engine maximum speed is not as specified on page 12, stop engine and check that with throttle lever fully forward the fuel pump lever contacts the full RPM stop at (A). If not:

1. Adjust position of cable anchor (C) in slots and/or
2. Adjust the linkage (B) between control cable and spring on fuel pump lever.

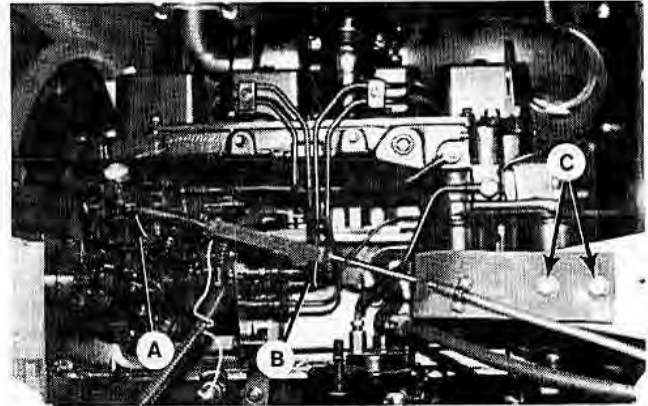

FUEL PUMP LEVER LINKAGE –
NON-TURBO

THROTTLE ROD ADJUSTMENT

For the non-turbo engine:

1. With throttle lever in the low idle position (fully back), fuel pump lever should contact slow speed stop screw at (C).

If not:

2. Adjust position of cable anchor (A) in slots until lever contacts stop screw at (C).

And/or

3. Adjust length of throttle linkage as follows:
 - Loosen jam nut (D) on throttle rod.
 - Lengthen throttle rod assembly with nut (F) until lever contacts stop screw at (C).
 - Secure position by tightening nut (D).

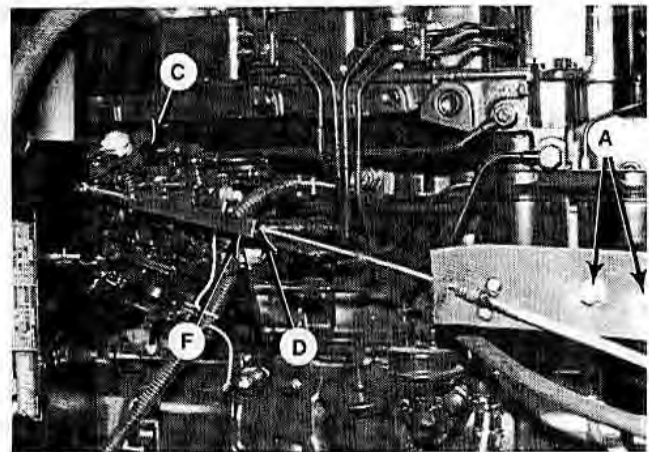

THROTTLE ROD ADJUST. – NON-TURBO

MAINTENANCE/SERVICE

Diesel Engine

ENGINE SPEED (continued):

TURBO ENGINE

THROTTLE ROD ADJUSTMENT

Throttle lever in cab should move fuel pump lever the full range between slow speed stop and full RPM stop without contacting the console at either end. To adjust, reposition cable anchor in slots (C).

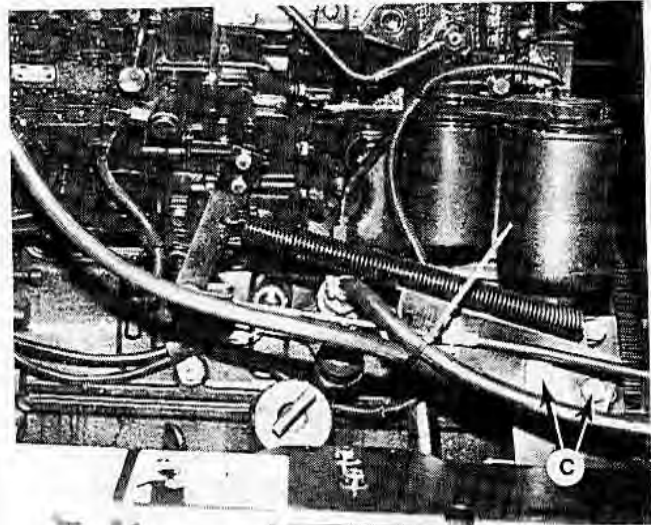

THROTTLE ROD ADJUSTMENT - TURBO

NOTE: For machines without in-cab tachometer, hand held tach can be attached at bevel gear box output shaft. For access to end of shaft, remove cover (D) on right side of tractor frame.

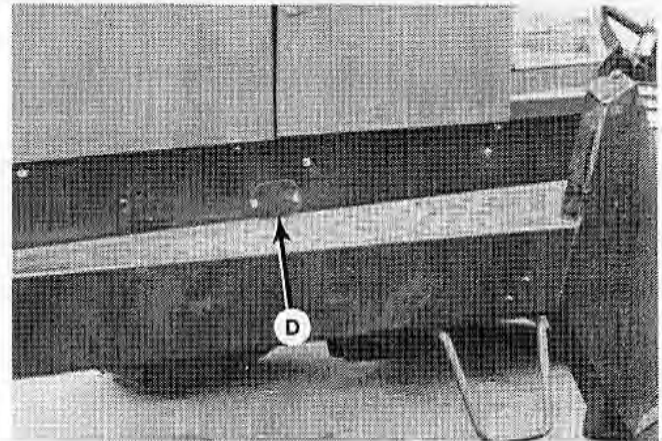

ACCESS TO GEARBOX SHAFT
FOR TACHOMETER

VALVE TAPPET CLEARANCE

Every 1000 hours of operation, have diesel engine valve tappet clearance checked and adjusted by your Windrower dealer.

GENERAL ENGINE INSPECTION

Every 2000 hours of operation, see your Windrower dealer for required general service or tune-up.

For diesel engine, have fuel injection pump and nozzles inspected at this time.

MAINTENANCE/SERVICE

Diesel Engine: Air Intake System

AIR CLEANER

IMPORTANT: Do not run engine with air cleaner disconnected or disassembled.

The air cleaner is equipped with a vacuator valve which removes dust continuously from the air cleaner housing.

Check daily that system is functioning properly:

1. Remove air cleaner end cap (A).
2. Check for dust inside the canister.
3. If dust or debris is present, clean canister and check for the source of the contamination. Possibilities are:
 - a) Obstruction in vacuator valve (B). Clean or replace if necessary.
 - b) Loose connection at any air-intake hose clamp. Tighten hose clamp.
4. Replace air cleaner end cap.

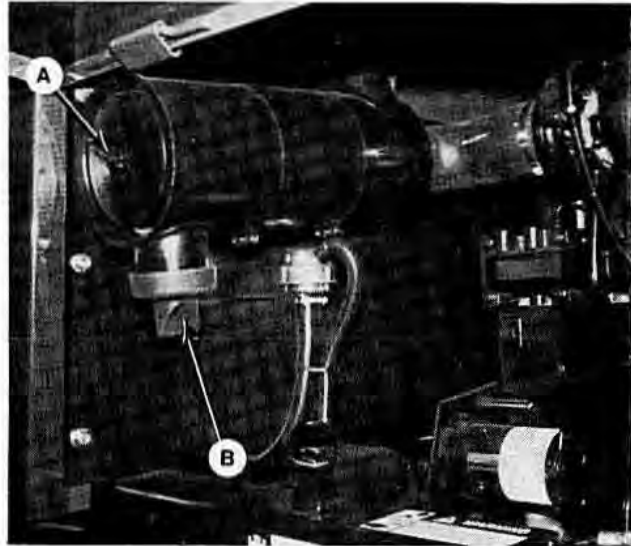

AIR CLEANER

FILTER ELEMENTS - CLEANING AND INSPECTION

The diesel engine air cleaner is equipped with a restriction gauge (A) which signals red when the primary filter element requires cleaning. Check restriction gauge daily with engine running at full speed. Never clean filter element unless restriction gauge signals red. Excessive cleaning will shorten element life. After cleaning, re-set restriction gauge by pushing button on top of gauge.

IMPORTANT: The air cleaner is a dual element type. Clean the primary (outer) element only. Do not attempt to clean the secondary (inner) element. If there is visible dirt on the secondary element, replace both primary and secondary elements. See "Filter Elements - Replacement" for normal change interval.

To clean air filter element:

1. Remove element from air cleaner canister.
2. Clean inside of canister and cover with a cloth.
3. Inspect element as follows:
 - Hold a bright light (B) inside element and check carefully for holes. Discard any element which shows the slightest hole.
 - Be sure outer screen (C) is not dented. Vibration would quickly wear a hole in the filter.
 - Be sure filter gasket (D) is in good condition. If gasket is damaged or missing, replace element.
4. Pat sides of element gently to loosen dirt. Do not tap element against a hard surface.

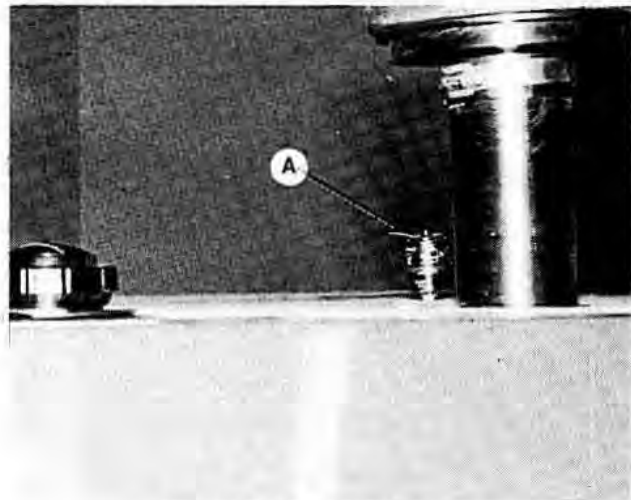

RESTRICTION GAUGE

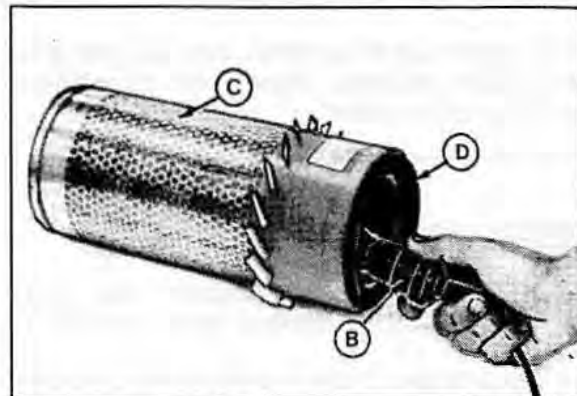

INSPECT ELEMENT

MAINTENANCE/SERVICE

Diesel Engine: Air Intake System

AIR CLEANER

CLEANING FILTER ELEMENTS (continued)

- Using a Dry Element Cleaner Gun, clean element with compressed air.

Hold nozzle next to inner surface, and move up and down pleats.

IMPORTANT: Air pressure must not exceed 100 psi (700 kPa). Do not direct air against outside of element, as dirt might be forced through to inside.

- Repeat steps 4 and 5 to remove additional dirt.
- If washing is not necessary, repeat inspection (Step 3) before installing.
- If element is coated with oil or soot, wash in a solution of warm water and Filter Element Cleaner (Donaldson D1400 or equivalent) as follows:

- Let element soak in solution at least 15 minutes, then agitate gently to flush out dirt.

- Rinse element thoroughly from inside with clean water. Use element cleaning gun or a free-running hose (maximum pressure 40 psi [275 kPa]; higher pressures can damage element).

- Allow element to dry completely before using. This usually takes from one to three days. Do not oven dry, or use compressed air or other drying agents. Protect element from freezing until dry.

- Inspect element (Step 3) before re-installing.

- Inspect the air intake piping for damage, cracked hoses, loose clamps, etc.



CLEAN WITH COMPRESSED AIR

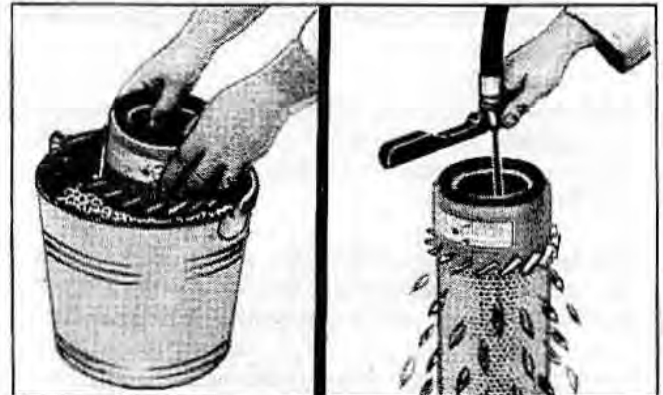

WASH AND RINSE ELEMENT

FILTER ELEMENTS - REPLACEMENT

The air cleaner's primary (outer) filter element should be replaced after six cleanings or at least every three years.

The secondary (inner) element must not be cleaned, and should be replaced every third time the primary element is changed.

MAINTENANCE/SERVICE

Diesel Engine: Fuel System

STORING FUEL

- Buy good quality, clean fuel from a reputable dealer.
- Proper fuel storage is critically important. Keep all dirt, water and other contaminants away from fuel.
- Avoid storing fuel over long periods of time. If you have a slow turnover of fuel in windrower tank or supply tank, add fuel conditioner to avoid condensation problems.
- Store fuel in a convenient place away from buildings.

REFUELLING WINDROWER



WARNING: To avoid personal injury or death from explosion or fire, do not smoke or allow flame or sparks near fuel tank when refuelling.

Never refuel the windrower when the engine is hot or running.

IMPORTANT: Do not fill tank completely; space is required for expansion. A filled tank could overflow if exposed to a rise in temperature, such as direct sunlight.

Fill fuel tank daily, preferably at the end of the day's operation. This prevents condensation in the tank as moist air cools overnight.

See "Fuels, Fluids and Lubricants" for recommended fuels.

IMPORTANT: Do not allow tank to empty. Running out of fuel can cause air locks and/or contamination of the fuel system. See "Fuel System Air Removal" in this section.

TANK CAPACITY is 51 U.S. gallons (193 litres).



REFUEL SAFELY

FUEL TANK VENTING

If fuel tank cap requires replacement, be sure to order the original equipment part, which is NOT vented.

The fuel tank is vented by hose (A), which is connected to filler tube. Change filter (B) at end of vent hose annually.

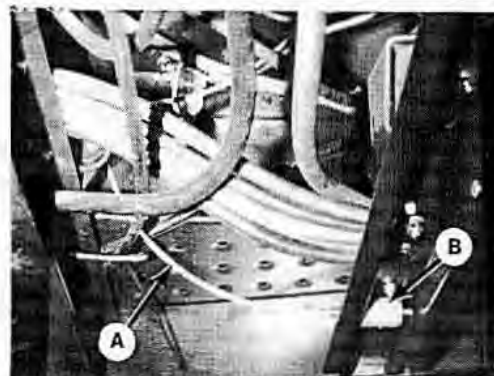

FUEL TANK VENT HOSE

MAINTENANCE/SERVICE

Diesel Engine: Fuel System

FUEL SEDIMENT BOWL

Inspect fuel sediment bowl daily for water or other contaminants. Bowl is located under tank. Clean as required.

To clean:

1. Close valve (A) to shut off fuel.
2. Loosen nut (B) and remove bowl.
3. Clean bowl and mesh screen in head.
4. Replace bowl and open valve (A).

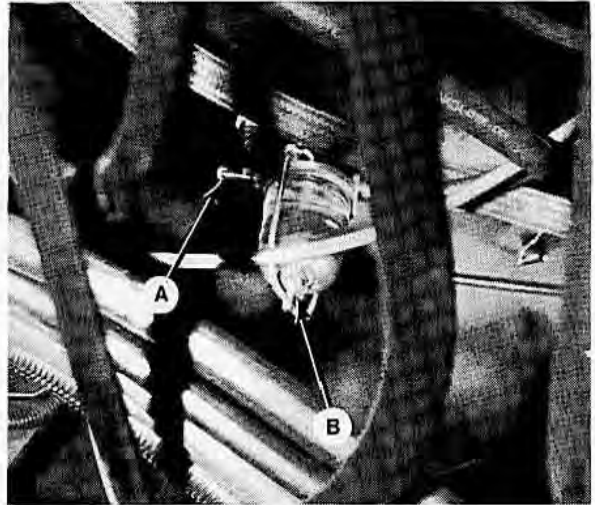

FUEL SEDIMENT BOWL

FUEL/WATER SEPARATOR - DIESEL ENGINE

Drain the water and sediment from the separator at the fuel filter daily, as follows:

1. Shut off engine.
2. Open the drain valve (A) by hand, 1½ to 2 turns counter-clockwise until draining occurs.
3. Drain the filter sump of water until clear fuel is visible.
4. **IMPORTANT:** Do not over-tighten valve. Damage to threads may result.

Turn the valve clockwise to close the drain valve.

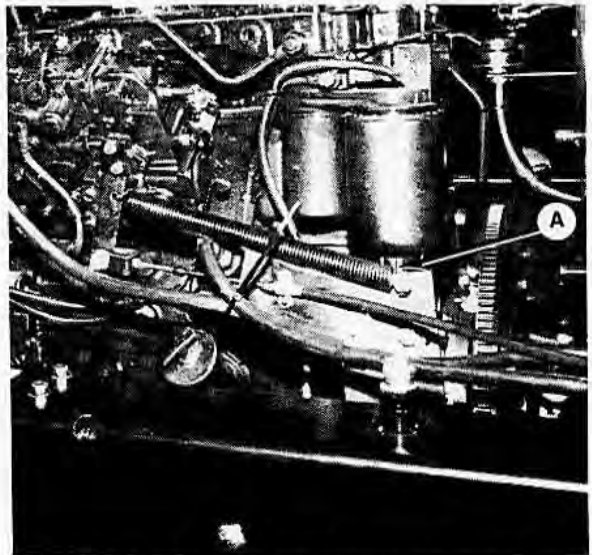

FUEL/WATER SEPARATOR - DIESEL

MAINTENANCE/SERVICE

Diesel Engine: Fuel System

FUEL FILTERS - DIESEL ENGINE

Change fuel filters every 500 hours of operation.

To change:

1. Close valve (A) under fuel tank to shut off fuel.

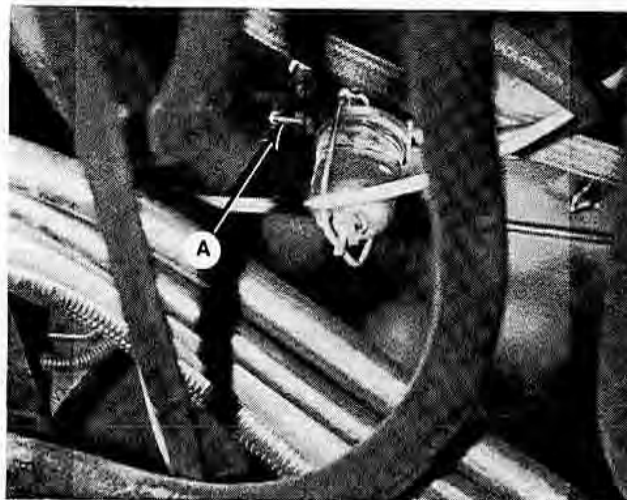

FUEL SHUT-OFF VALVE

2. Clean the filter head, filters and the engine area next to the filters.
3. Remove the two filters using a filter wrench.

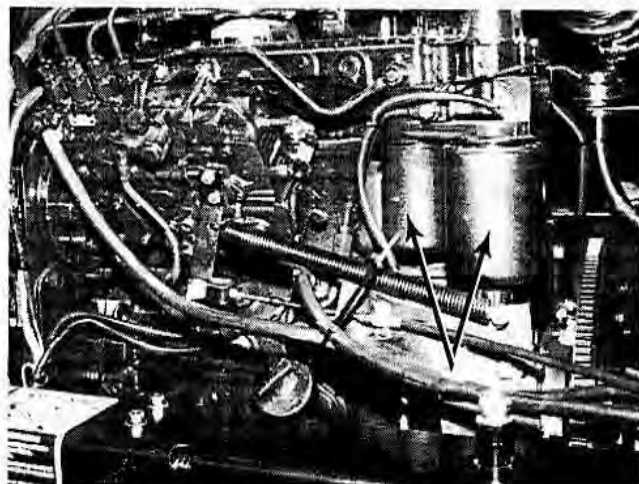

REMOVE FILTERS

4. **IMPORTANT:** Fill the new filters with clean fuel and apply a thin film of clean oil to the filter gaskets.
5. Install the new filters. Turn the filters onto the mount until the gasket contacts the filter head. Tighten the filter an additional 1/2 turn to 3/4 turn by hand.

IMPORTANT: Do not use a filter wrench to install filters. Overtightening can damage the gasket and filter.

6. Open valve (A) under tank.

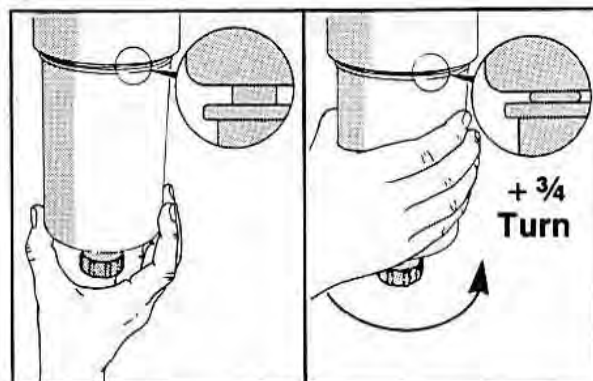

INSTALL FILTERS

MAINTENANCE/SERVICE

Diesel Engine: Fuel System

FUEL SYSTEM AIR REMOVAL - DIESEL ENGINE

Controlled venting of air is provided at the injection pump through the fuel drain manifold. Small amounts of air introduced by changing filters or injection pump supply line will be vented automatically, if the fuel filter is changed in accordance with instructions. (See "Fuel Filters".) However, manual venting ("bleeding") may be required if:

1. The fuel filter is not filled prior to installation.
2. Injection pump is replaced.
3. High-pressure fuel lines are replaced.
4. Engine is run until fuel tank is empty.

To bleed LOW pressure lines and fuel filters:

1. Loosen the bleed screw (A) located at the outlet fitting from the fuel filter housing.
2. Push plunger (B) on the lift pump until clear fuel with no air bubbles flows from around the bleed screw.
3. Tighten the bleed screw (A).

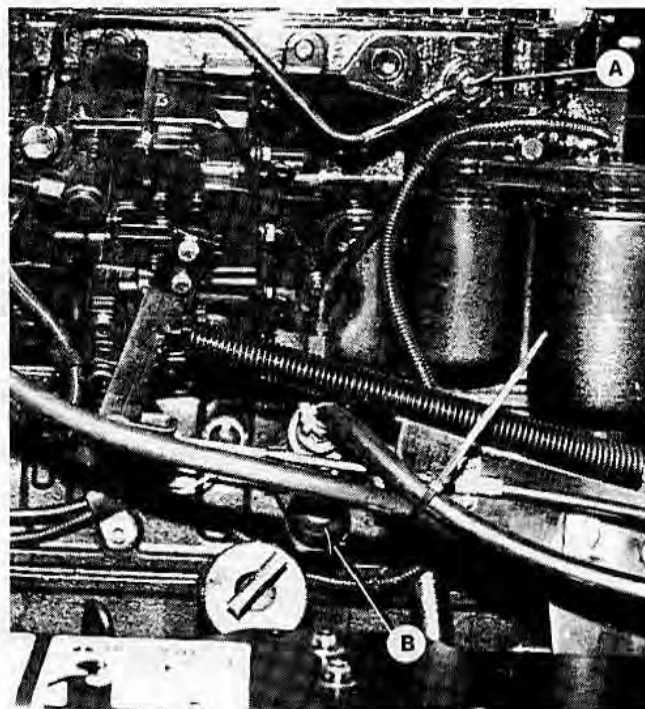

BLEEDING LOW PRESSURE LINES
AND FILTERS

MAINTENANCE/SERVICE

Diesel Engine: Fuel System

FUEL SYSTEM AIR REMOVAL - DIESEL ENGINE (continued)

To bleed high pressure lines:



WARNING: Escaping fluid under pressure can penetrate the skin causing serious injury. When disconnecting diesel lines, have engine stopped and loosen fittings slowly to relieve pressure. Tighten all connections before applying pressure. Keep hands and body away from pin-holes and nozzles which eject fluids under high pressure. Use a piece of cardboard or paper to search for leaks. Do not use your hand.

If ANY fluid is injected into the skin, it must be surgically removed within a few hours by a doctor familiar with this type of injury or gangrene could result.



WARNING: Do not bleed a hot engine as this could cause fuel to spill onto a hot exhaust manifold creating a danger of fire.



WARNING: It is necessary to have the engine cranking for this procedure. Two persons will be required; one to turn ignition switch and one to watch the injector connections.

Use extreme care when working around moving parts. Wear close fitting clothing and protective eye-wear. Keep hands, feet, clothing and hair away from moving parts.

1. With engine stopped, slowly loosen fittings at the injectors as shown.
2. Turn key in ignition switch fully clockwise to START position) and crank for 15 seconds maximum. Allow starter to cool for two minutes before cranking again.
3. When clear fuel with no air bubbles flows from the connections, stop cranking the engine and tighten fittings.



AVOID PRESSURIZED FLUID

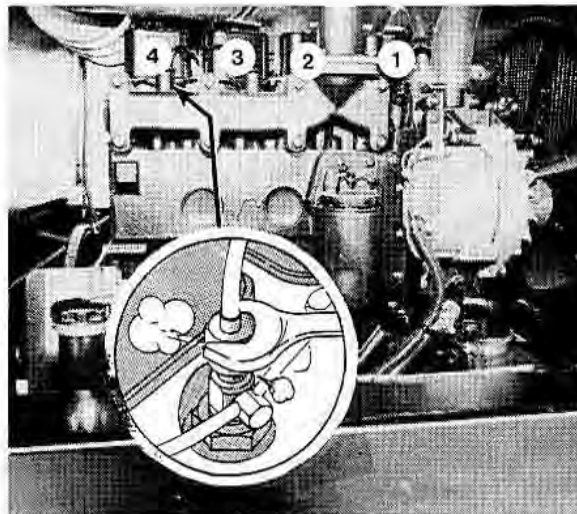

BLEEDING HIGH PRESSURE LINES

MAINTENANCE/SERVICE

Engine Exhaust System

MUFFLER



CAUTION: To avoid burns, do not touch muffler when engine is running or before allowing sufficient cooling time after shut-down.

For Naturally-Aspirated Diesel Engines:

Clean out muffler accumulation every 200 hours as follows:

1. Remove spark arrester plug (A).
2. Block off muffler outlet (B).
3. Start engine and run at idle until any accumulated debris is removed.
4. Remove blockage at (B) and replace plug.

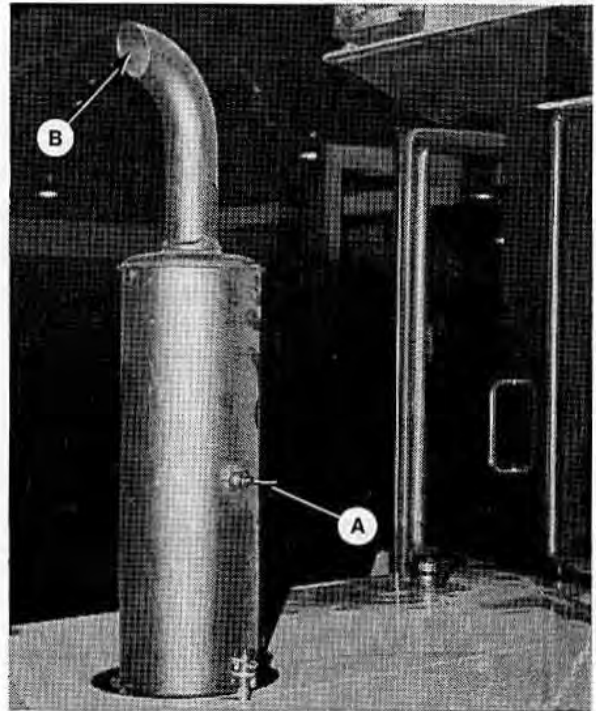

REMOVE SPARK ARRESTER PLUG
AND BLOCK OUTLET

MAINTENANCE/SERVICE

Engine Cooling System

COOLANT LEVEL

Check coolant level daily at reserve tank (A).
Check level when engine is cold.

If tank is less than half full, add coolant to reserve tank (A), not to radiator.

IMPORTANT: Use a 50/50 mix of clean, soft water and anti-freeze. This ratio will protect engine to temperatures of -30°F (-34°C).
Anti-freeze Specification: Ethylene-glycol or propylene-glycol fully formulated, containing a pre-charge supplemental coolant additive (SCA) and meeting ASTM Designation: D 4985.

Anti-freeze is essential in any climate. It broadens the operating temperature range by lowering the coolant freezing point and by raising its boiling point. Anti-freeze also contains rust inhibitors and other additives to prolong engine life.

IMPORTANT: If anti-freeze strength is not adequate, do not drain cooling system to protect against freezing. System may not drain completely, and damage could result.

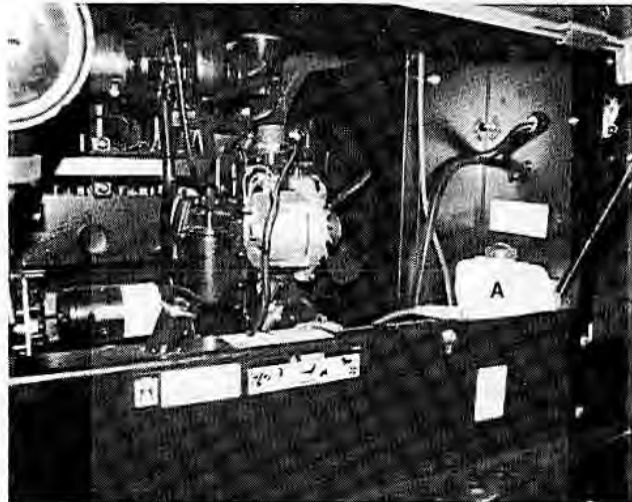

MAINTAIN COOLANT LEVEL

RADIATOR CAP

The radiator cap must fit tightly and the cap gasket must be in good condition to maintain the 7 psi (58 kPa) pressure in the cooling system.



CAUTION: To avoid personal injury from hot coolant, do not turn radiator cap until engine has cooled.

Turn the cap to the first notch to relieve pressure before removing cap completely.

ANTI-FREEZE CONCENTRATION

Check the anti-freeze concentration with a tester once per season, preferably before off-season storage. Protect the engine to -30°F (-34°C) with a 50/50 anti-freeze and water mixture.

MAINTENANCE/SERVICE

Engine Cooling System

CHANGING COOLANT

Coolant should be removed, and the system flushed and filled with new coolant every 2 years.

Procedure:



CAUTION: To avoid personal injury from hot coolant, do not turn radiator cap until engine cools. Turn the cap to the first notch to relieve pressure before removing cap completely.

1. With engine cool and approximately level, remove radiator cap.

NOTE: A drain pan with a capacity of 8 U.S. gallons (30 litres) will be adequate.

2. Remove drain plug (B) from engine block.
3. Open radiator drain valve (C). Use a deflector if desired to prevent coolant running onto frame.
4. When system is drained, replace drain plug in block and close radiator drain valve.
5. Fill system with clean water and replace radiator cap.
6. Turn heater switch in cab ON and leave it on until flushing is complete.
7. Start and run engine until normal operating temperature is reached.
8. Stop engine and drain water out before rust or sediment settles.
9. Close drain valves and fill system with a solution of clean water and a heavy duty radiator cleaner. Follow instructions provided with cleaner.
10. After using cleaner solution, again flush system with clean water. Inspect radiator, hoses and fittings for leaks.
11. Close drain valves and fill system with a 50/50 mix of anti-freeze and clean, soft water.

SYSTEM CAPACITY -

Diesel Engine: 4.8 U.S. gallons (18 litres)

Anti-freeze Specification: Ethylene-glycol or propylene-glycol fully formulated, containing a pre-charge supplemental coolant additive (SCA) and meeting ASTM Designation: D 4985.

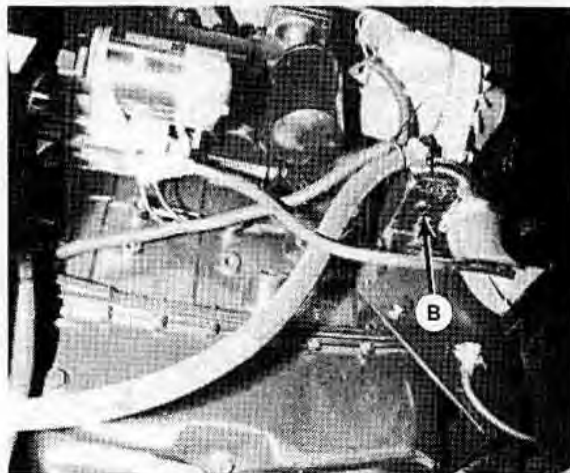

BLOCK DRAIN - DIESEL ENGINE

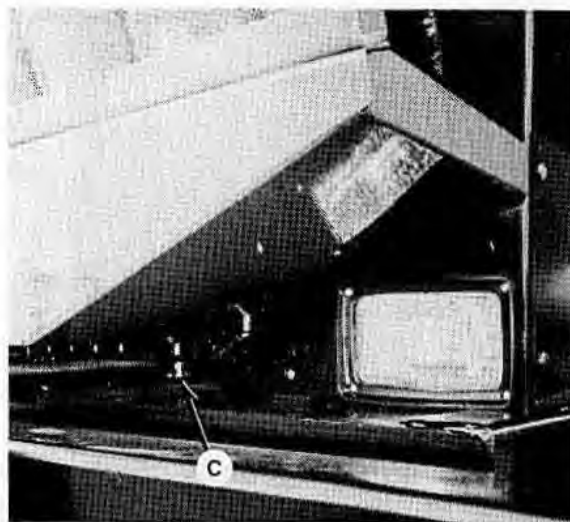

RADIATOR DRAIN

Engine Cooling System

SCREENS AND COOLERS

RADIATOR SCREEN

The radiator screen may be equipped with an automatic cleaning device which "vacuums" the screen by means of two rotors. If the rotors (A) should stop turning, check electrical connections to motor (B). The electrical circuit is protected by a 7.5 amp in-line fuse at (G). To check fuse, remove outer cover.

If rotors fail to clean the screen adequately, remove plastic arm and check for obstructions in ducting from screen to fan shroud.

For units not equipped with cleaning device, manually clean the screen periodically during a day's operation. Do not allow excessive trash build-up.

NOTE: The rotary cleaning device may be ordered as an attachment.

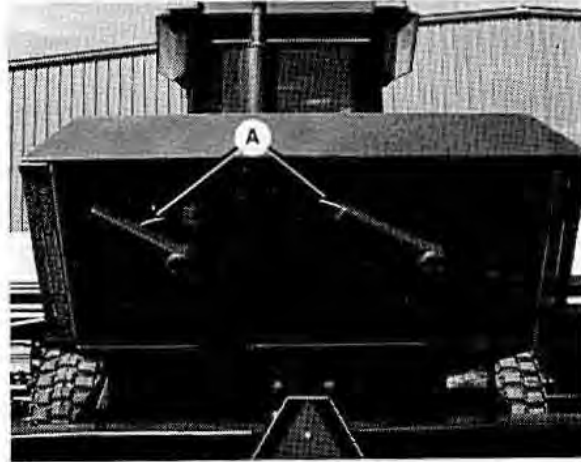

RADIATOR SCREEN

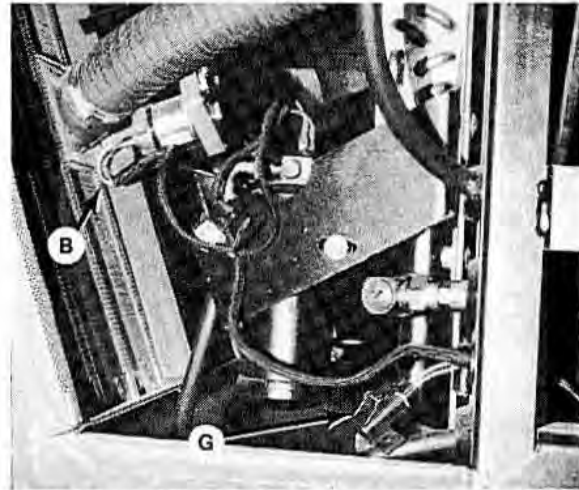

MOTOR CONNECTIONS - SCREEN ROTORS

RADIATOR (C), OIL COOLER (D) and CONDENSER (E) - Should be cleaned daily with compressed air. More frequent cleaning may be necessary in severe conditions.

For access to oil cooler and condenser, open engine compartment side panels.

For access to radiator, loosen wing nut (F), pivot retainer and swing cooler and condenser mount out.

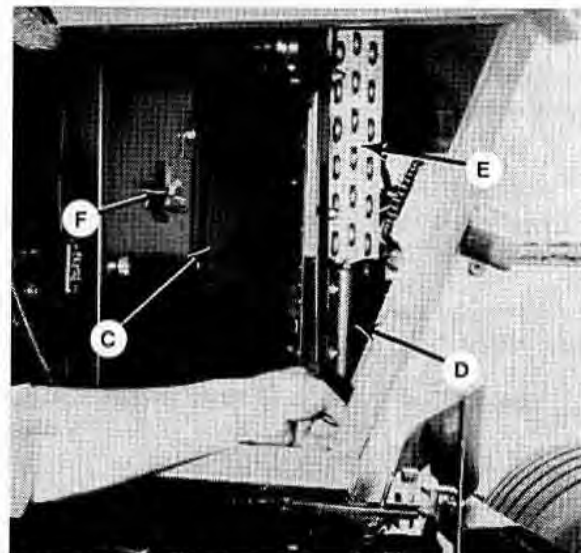

RADIATOR, OIL COOLER AND CONDENSER

Electrical System

BATTERY



WARNING:

- Gas given off by battery electrolyte is explosive. Keep all smoking materials, sparks and flames away from batteries.
- Follow proper charging and boosting procedures given in this section.
- Ventilate when charging in enclosed space.
- Always wear protective eye-wear when working near batteries.
- Do not tip batteries more than 45° to avoid electrolyte loss.
- Battery electrolyte causes severe burns. Avoid contact with skin, eyes or clothing.
- Keep batteries out of reach of children.
- If electrolyte is spilled or splashed on clothing or the body, neutralize it immediately with a solution of baking soda and water, then rinse with clean water.
- Electrolyte splashed into the eyes is extremely dangerous. Should this occur, force the eye open and flood with cool, clean water for five minutes. Call a doctor immediately.
- To avoid shocks, burns or damage to electrical system, disconnect battery ground cable before working in an area where you might accidentally contact electrical components.

NOTE: For easier battery installation or removal, position a low platform on which to stand when lowering or lifting battery.

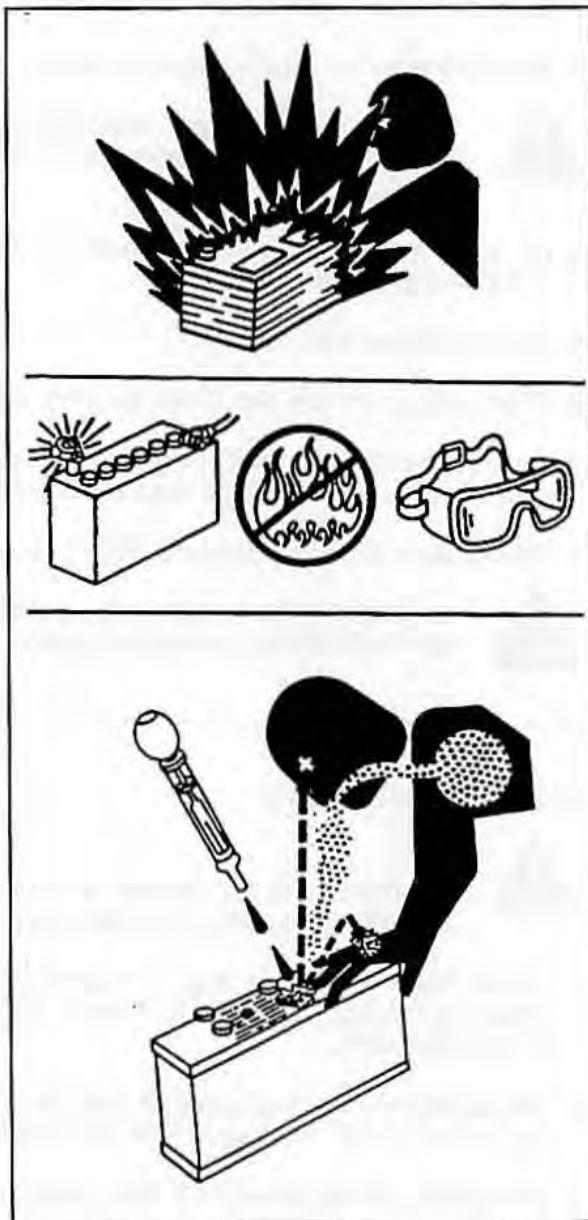

BE CAREFUL AROUND BATTERIES

MAINTENANCE/SERVICE

Electrical System

BATTERY (continued)

PREVENTING BATTERY DAMAGE

1. Be sure alternator connections are correct before cables are connected to battery. See "Preventing Alternator and Regulator Damage" in this section.
2. Carefully observe polarity when attaching booster battery.
3. Do not operate the engine with alternator or battery disconnected.



WARNING: With battery cables disconnected and engine running, a high voltage can be built up if terminals touch the frame. Anyone touching the frame under these conditions would be severely shocked.

4. Do not short across battery or alternator terminals, or allow battery positive (+) cable or alternator wire to become grounded.
5. Do not polarize the alternator.
6. When welding on any part of the machine, disconnect battery cables and alternator wire.
7. To prolong battery life, store batteries fully charged and at +20° to +80°F (-7° to +26°C). Check voltage after storage and recharge as needed, according to battery and charger manufacturer recommendations.
8. Do not stack storage batteries on top of each other.



CAUTION: When working around storage batteries, remember that all of the exposed metal parts are "live". Never lay a metal object across the terminals because a spark or short circuit will result.

BATTERY MAINTENANCE



CAUTION: Do not attempt to service battery unless you have the proper equipment and experience to perform the job. Have it done by a qualified dealer.

1. Check fluid level once a year. If necessary add distilled water (or clean rain water) to bring level to bottom of cell neck. Do not add water in freezing temperatures unless engine is run two to three hours to mix electrolyte.
2. Check battery charge once a year, more often if operating in cold weather. Hydrometer readings should be 1.260 to 1.300. Readings below 1.250 indicate charging is required. See "Charging Battery".
3. Keep battery clean by wiping it with a damp cloth.
4. Keep all connections clean and tight. Remove any corrosion and wash terminals with a solution of baking soda and water. A light coating of grease on terminals (after cables are attached) will reduce corrosion.
5. A replacement battery must have a rating of at least 640 (Diesel) / 560 (Gas) cold cranking amps at 0°F (-18°C).

IMPORTANT: BATTERY IS NEGATIVE GROUNDED. Always connect starter cable to the positive (+) terminal of battery and battery ground cable to negative (-) terminal of battery. Reversed polarity in battery or alternator may result in permanent damage to electrical system.

MAINTENANCE/SERVICE

Electrical System

BATTERY (continued)

CHARGING BATTERY



CAUTION:

- Ventilate the area where batteries are being charged.
- Do not charge a frozen battery. Warm to 60°F (16°C) before charging.
- Do not connect or disconnect live circuits. To prevent sparks, turn off charger and connect positive cable first. If charging battery in windrower, disconnect positive battery cable before connecting charger cable, then connect ground cable last, away from battery.
- Stop or cut back charging rate if battery feels hot, or is venting electrolyte. Battery temperature must not exceed 125°F (52°C).
- Follow all instructions and precautions furnished by the battery charger manufacturer. Charge at recommended rates and times.

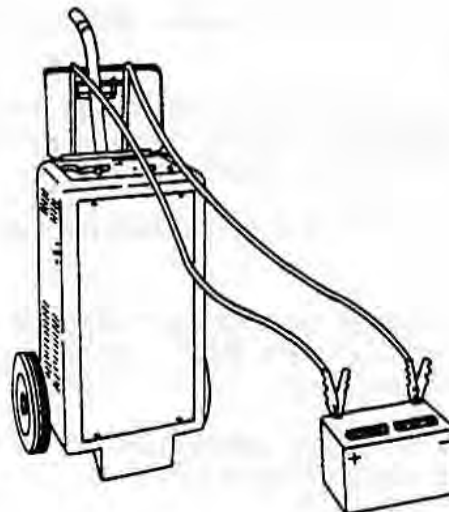

CHARGE BATTERIES SAFELY

USING A BOOSTER BATTERY

A twelve volt battery can be connected in parallel (+ to +) with the windrower battery. Use heavy duty battery cables.



CAUTION: Gas given off by batteries is explosive. Keep sparks and flames away from batteries. Make last connection and first disconnection at a point furthest away from the batteries. Wear protective eye-wear when using a booster battery. Be sure everyone is clear of machine when starting engine. Start engine from operator's station only.

1. Attach one cable to positive terminal (A) of booster battery.
2. Open left side panel to engine compartment and attach other end of cable to positive terminal (B) of windrower battery.
3. Attach second cable to negative terminal (C) of booster battery and good ground (D) on windrower frame.
4. Turn ignition switch in cab as with normal start up.
5. When disconnecting cables, remove cable from ground (D) first.



CAUTION: Avoid contact with moving parts when disconnecting cable at windrower battery terminal (B). Never wear loose fitting or dangling clothing.

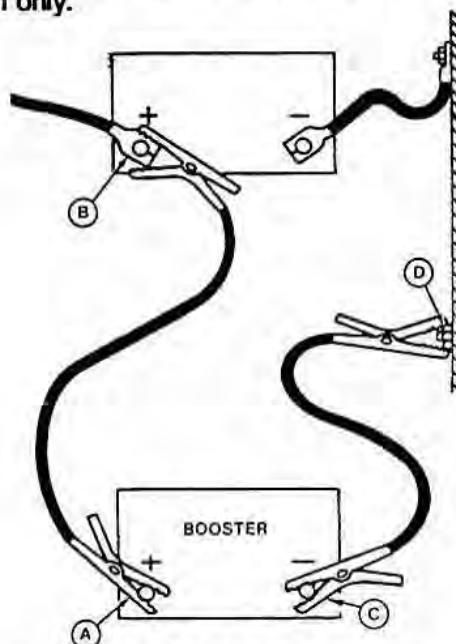

ATTACHING BOOSTER BATTERY

MAINTENANCE/SERVICE

Electrical System

PREVENTING ALTERNATOR AND REGULATOR DAMAGE

1. Always disconnect battery ground cable when working with the alternator or regulator.
2. Never attempt to polarize alternator or regulator.
3. If wires are disconnected from the alternator (B) or regulator (C), use the photo at right to ensure proper reconnection.
4. Never ground the alternator field terminal or field circuit.
5. Never connect or disconnect alternator or regulator wires with battery connected or alternator operating.
6. Always disconnect cables from the battery when charging battery in windrower.
7. Connect all cables before operating engine.

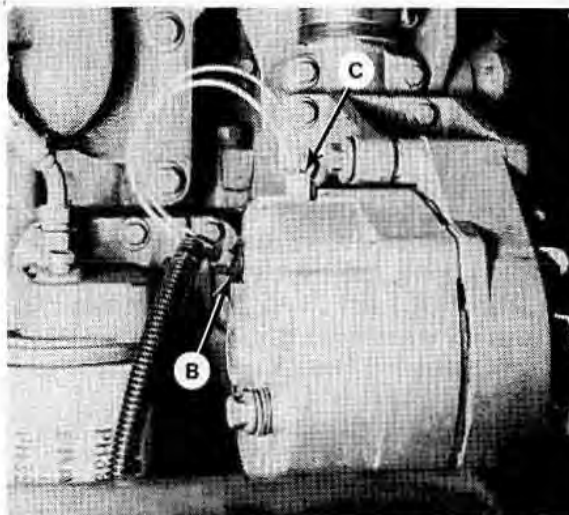

ALTERNATOR/REGULATOR WIRING

MAINTENANCE/SERVICE

Electrical System

LAMPS AND BULBS

SERVICING LAMP BULBS

1. If all lights fail at the same time, check if re-set button is popped out on the lights circuit breaker at the engine. If so, push it in. See "Circuit Breakers" in this section.
2. If a single lamp fails, bulb may be burned out, or it may have a faulty ground.
3. If problem is other than circuit breaker, bulb, or ground, see your Windrower dealer.

REPLACING HEAD OR FIELD LAMPS

1. Turn light switch and ignition key to OFF.



CAUTION: To avoid a slip and fall injury when replacing lamps at front of machine, remove header and use a step ladder.

2. Remove four screws from lamp bezel (A).
3. Unplug connector (B) and connect to new sealed beam.

NOTE: Replacement sealed beam trade #:
Head Lamp - (two at front center of cab):
#H-9411

Wide-Flood Field Lamp - (three each side of cab): #H-9406

Medium-Flood Field Lamp - (one at rear of tractor): #H-9414

IMPORTANT: For proper lighting pattern, be sure sealed beams are installed right side up.

4. Replace lamp and bezel, securing with four screws.

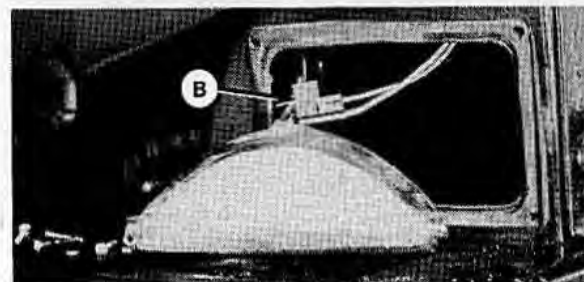
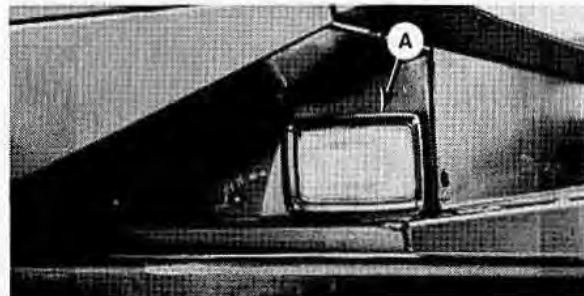

REPLACING SEALED BEAMS

REPLACING FLASHING AMBER OR RED TAIL LIGHT BULBS

1. Remove two screws (A). Remove plastic lens.
2. Replace bulb and reinstall plastic lens.

NOTE: Bulb trade #1156.

IMPORTANT: For proper lighting pattern, be sure plastic lenses are installed right side up.

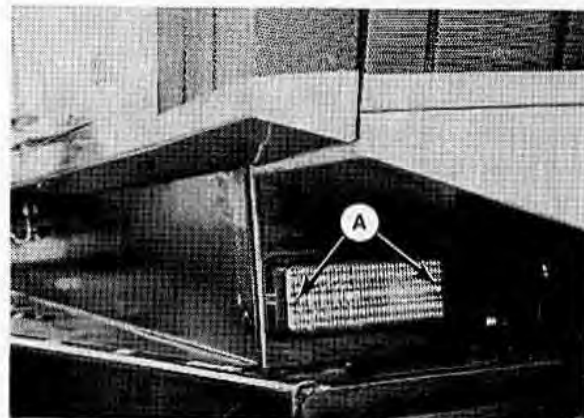

AMBER AND RED LIGHTS

MAINTENANCE/SERVICE

Electrical System

LAMPS AND BULBS (continued)

REPLACING MACHINE MONITOR LIGHT BULBS

1. Turn light switch and ignition key to OFF.
2. Remove six screws (three per side) from instrument panel (A). While pulling out on top of instrument panel, pull up until panel clears side console.
3. To replace warning lights (B) for engine oil pressure, transmission oil pressure or parking brake:
 - a) Remove two wires.
 - b) Remove retainer clip (C).
 - c) Push out entire unit and replace.**NOTE:** It may be necessary to replace the retainer clip (C) when replacing warning lights.

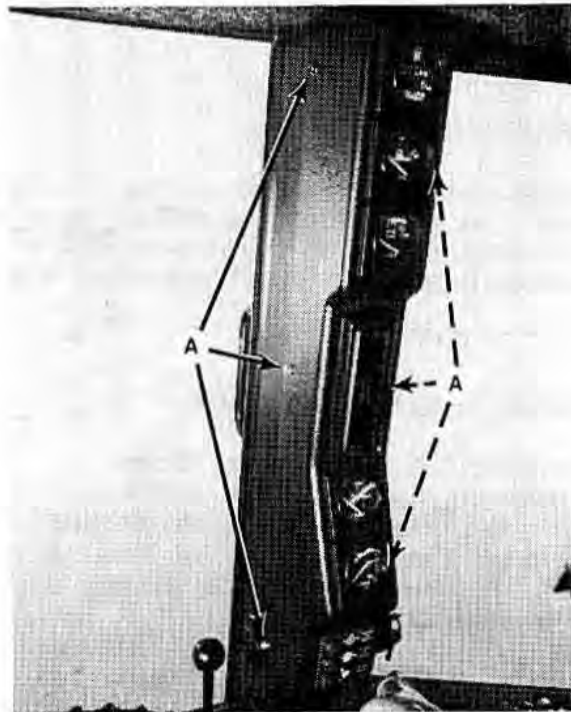

REMOVE INSTRUMENT PANEL

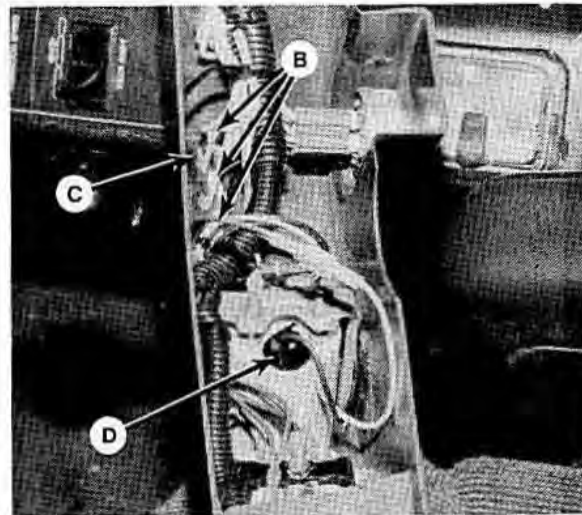

WARNING LIGHTS & GAUGE LIGHTS

4. To replace gauge lights, twist and pull bulb holder (D) from back of gauge and replace bulb.
NOTE: Bulb trade #161 (except tachometer).
Tachometer bulb trade #1816

REPLACING DOME LIGHT BULB

1. Un-snap plastic lens (D) from fixture by hand.
2. Replace bulb and reinstall plastic lens.
NOTE: Bulb trade #211-2TS.

REPLACING TURN SIGNAL INDICATORS

1. Remove cover (F).
2. Reaching inside overhead panel, remove retainer clip at turn signal unit.
3. Push out entire unit (E), detach wiring and replace.

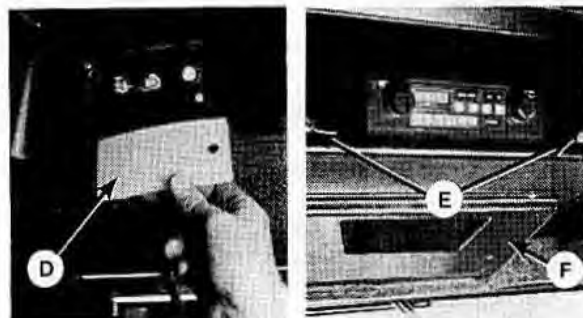

DOME LIGHT AND TURN INDICATORS

MAINTENANCE/SERVICE

Electrical System

CIRCUIT BREAKERS

CHECKING IN-CAB CIRCUIT BREAKERS

For access to breakers, remove lower panel to right of operator's seat.

These breakers will reset automatically after approximately one minute.

See your dealer if circuits do not operate correctly.

- (A) - Wiper, Interior Light, Radio Memory, Two-Way Radio - 6 amp
- (B) - Instruments, Radio - 6 amp
- (C) - Air Conditioning, Header Controls, Seat Switch - 25 amp

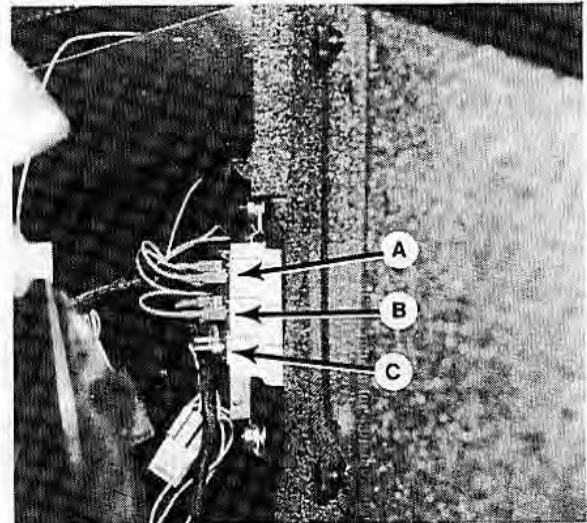

IN-CAB CIRCUIT BREAKERS

CHECKING 50 AMP CIRCUIT BREAKERS

The 50 amp circuit breakers are located behind a shield attached to the left radiator mount.

If none of the lights will operate, check if re-set button is popped out on lights circuit breaker (E). (Button is located on bottom of breaker and can be reached by hand)

If none of the electrical functions other than lights will operate, check if re-set button is popped out on bottom of circuit breaker (F).

If re-set button is out, the breaker has opened. Push the button in to reset circuit breaker.

Breakers should not open regularly under normal operating conditions. If repeated breaker opening occurs, see your dealer.

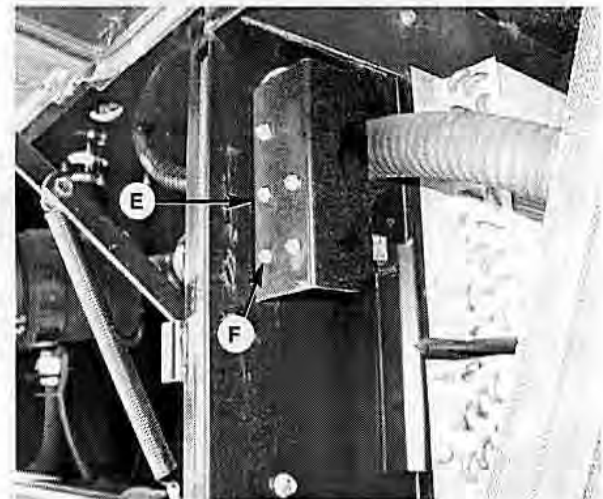

50 AMP CIRCUIT BREAKERS
(BEHIND SHIELD)

RADIO & TWO-WAY RADIO INSTALLATION

Instructions for installation of a radio and two-way radio are provided in Assembly section.

Electrical System Schematic: Cab (continued)

LEGEND

BLACK	GROUND
RED	LIVE POWER SUPPLY
PINK	ACCESSORY POWER SUPPLY
WHITE	ENGINE IGNITION / AIR SCREEN MOTOR
YELLOW	MACHINE MONITORS
BROWN	WIPER
BLUE	LIGHTS
ORANGE	AIR CONDITIONING
GREEN	HEADER FUNCTIONS

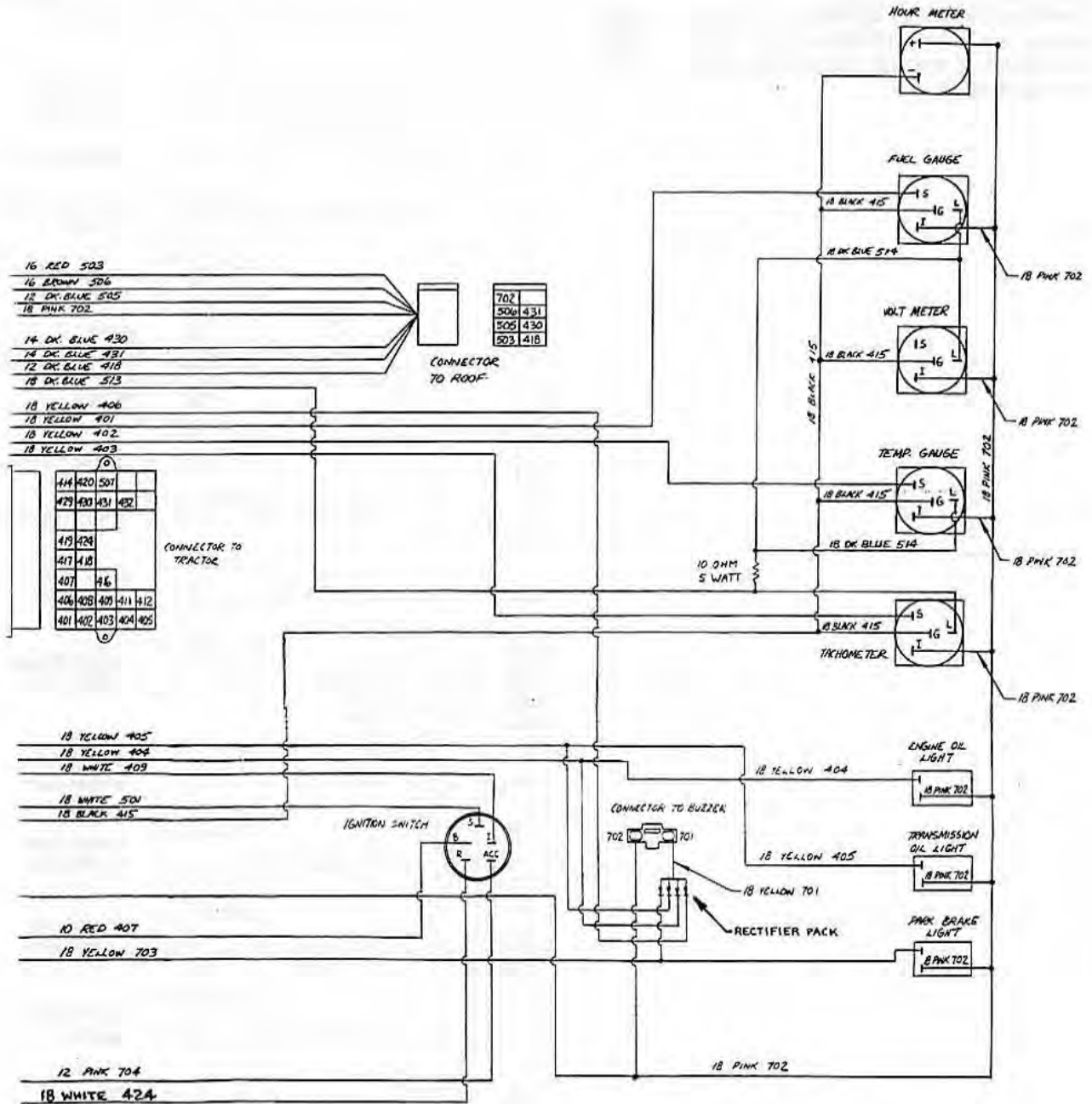

Electrical System Schematic: Roof

LEGEND

BLACK	GROUND
RED	LIVE POWER SUPPLY
PINK	ACCESSORY POWER SUPPLY
BROWN	WIPER
TAN	SPEAKERS
BLUE	LIGHTS

NOTE: Circuits are identified by wire gauge, color, and circuit number.
 Example: 16 ORANGE 985 is 16 gauge wire with orange insulation and the circuit number is 985.
 This refers to the line immediately below, unless indicated otherwise.

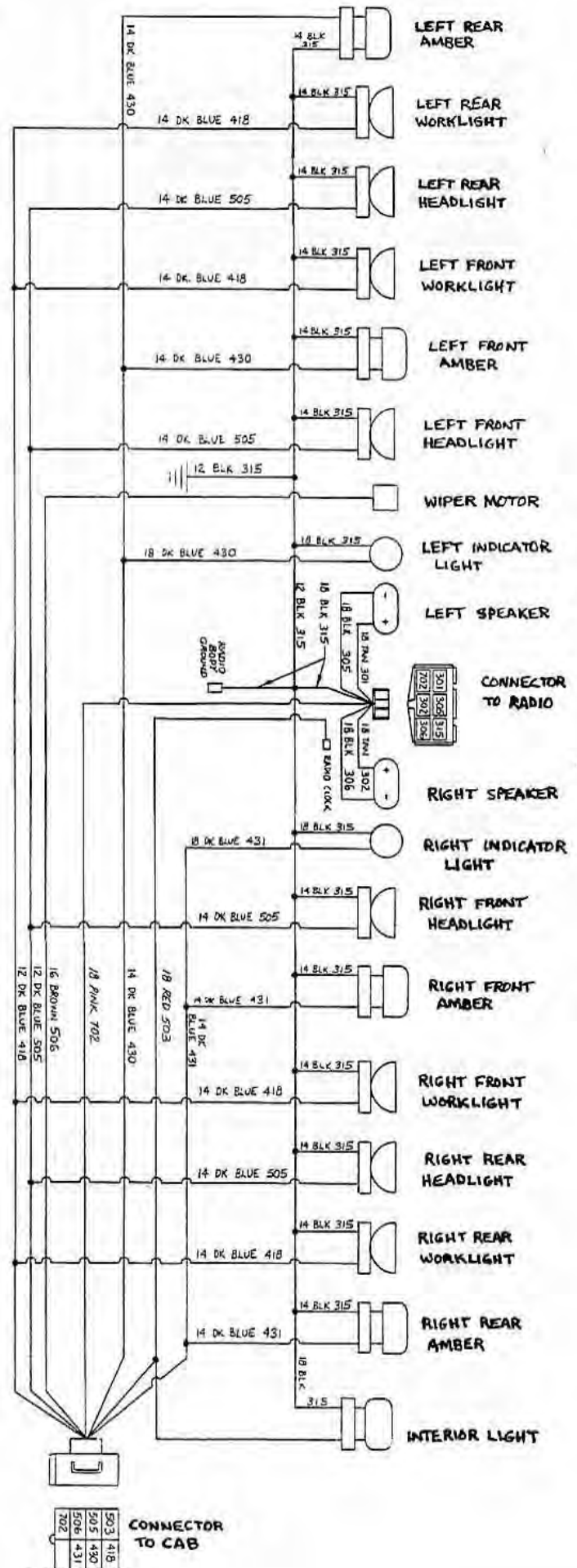

Electrical System Schematic: Tractor

LEGEND

BLACK	GROUND
RED	LIVE POWER SUPPLY
PINK	ACCESSORY POWER SUPPLY
WHITE	ENGINE IGNITION / AIR SCREEN MOTOR
GRAY	NEUTRAL INTERLOCK
YELLOW	MACHINE MONITORS
BLUE	LIGHTS
ORANGE	AIR CONDITIONING
GREEN	HEADER FUNCTIONS

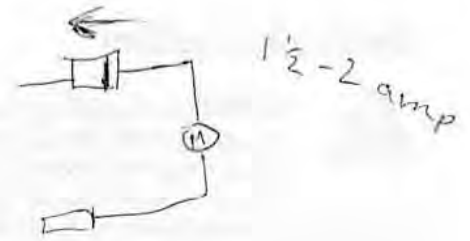

* - DO NOT MAKE THIS CONNECTION FOR NON-TURBO ENGINES

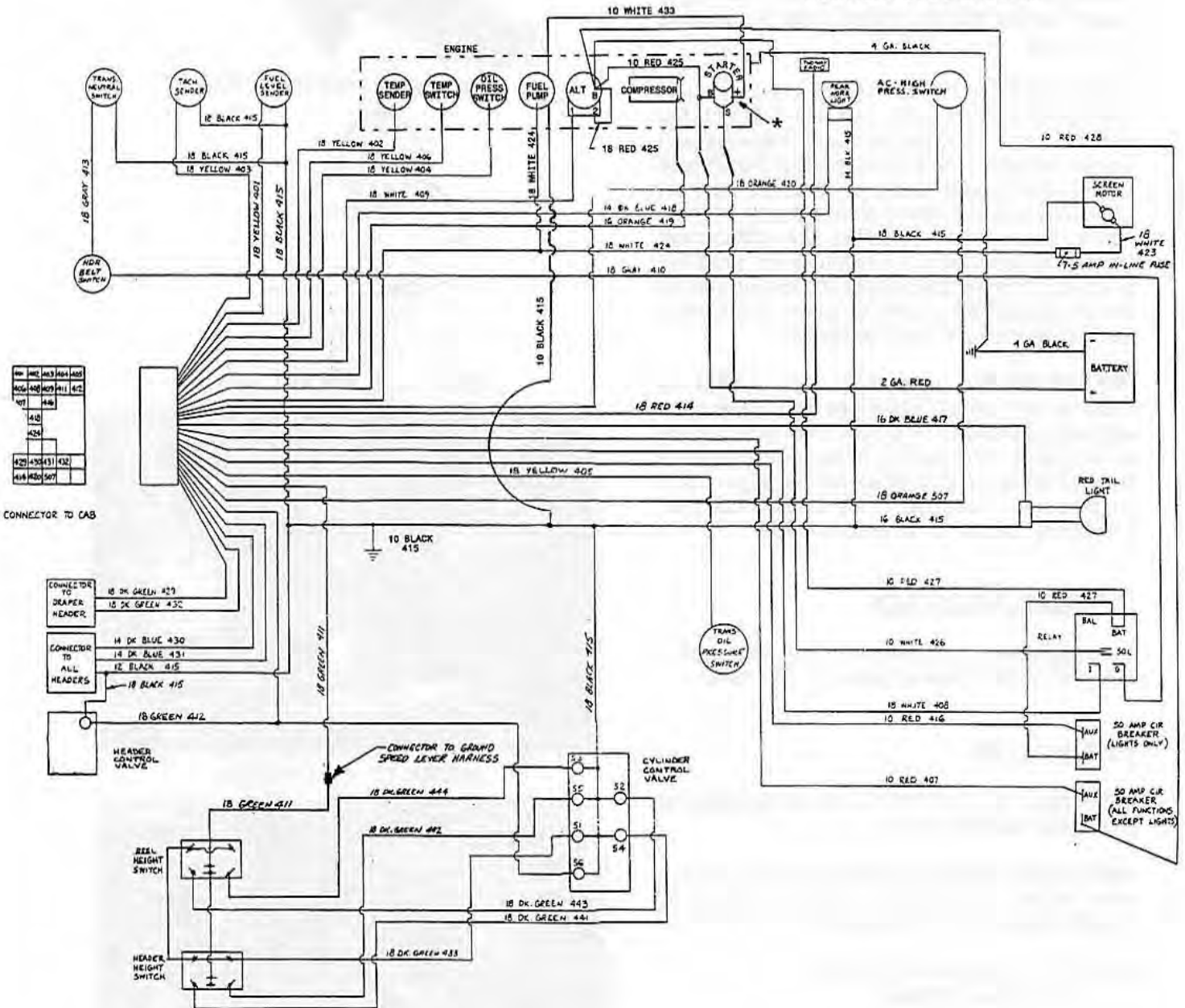

MAINTENANCE/SERVICE

Hydraulic System



WARNING: Avoid high pressure fluids. Escaping fluid can penetrate the skin causing serious injury. Relieve pressure before disconnecting hydraulic lines.

Tighten all connections before applying pressure. Keep hands and body away from pin-holes and nozzles which eject fluids under high pressure. Use a piece of cardboard or paper to search for leaks. If ANY fluid is injected into the skin, it must be surgically removed within a few hours by a doctor familiar with this type of injury or gangrene may result.

IMPORTANT: Dirt, dust, water and foreign material are the major causes of trouble developing in the hydraulic system. If the hydraulic system should be disconnected for service, protect the ends of hoses, tubing and ports of components from contamination with clean, lint-free towels or clean plastic bags. Before installing any replacement hose, flush the inside of it with unused diesel fuel or unused commercial petroleum cleaning solvent for ten seconds minimum. Do not use water, water soluble cleaners or compressed air.

IMPORTANT: The components in this system are built to very close tolerances and have been adjusted at the factory. Do not attempt to service these components except to maintain proper oil level, change oil and filters and to adjust relief pressures as described in this manual. See your Windrower Dealer for all other service.

HYDRAULIC OIL COOLER

Clean daily with compressed air. See "Screens and Coolers" under Cooling System Maintenance.

HYDRAULIC OIL

With tractor on level ground, check hydraulic oil level daily on dipstick (A).

Maintain level between "LOW" and "FULL" marks, with header lift cylinders retracted. Use SAE 10W30 Class SF or CC engine oil.

CAPACITY - LOW MARK TO FULL:
1 U.S. gallon (4 litres)

When storing machine for an extended time, add oil to top of filler neck. Drain off excess oil to proper level before next use by removing drain plug (B) from bottom of reservoir.

Replace plug and check level at dipstick.



AVOID HIGH PRESSURE FLUIDS



CHECK PROPERLY FOR LEAKS

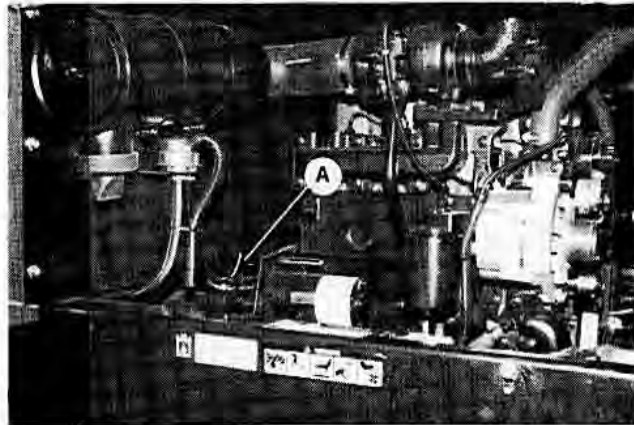

HYDRAULIC OIL DIPSTICK

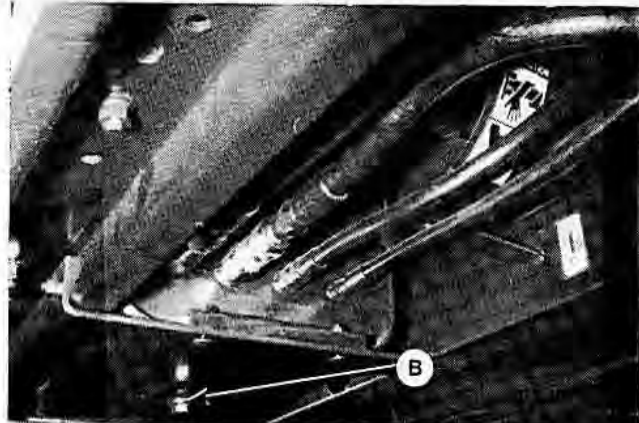

TO DRAIN EXCESS OIL

MAINTENANCE/SERVICE

Hydraulic System

HYDRAULIC OIL

Change hydraulic oil every 2000 hours.

To change:

1. Remove drain plug (B) from bottom of reservoir. Allow oil to drain.

NOTE: A drain pan with a capacity of 20 U.S. gallons (75 litres) will be required.

2. Replace the hydraulic oil filter. See "Hydraulic Oil Filters" in this section.
3. Clean off any metal debris which may have accumulated on magnetic drain plug. Replace plug (B).
4. Fill the system with oil through the filler neck. See "Fuels, Fluids and Lubricants" for recommended oil type. Check oil level with dipstick periodically during filling to prevent spill-over.

CAPACITY:

Reservoir only: 14.4 US gal. (54 litres)
Total system: approximately 17 US gal.
(65 litres) (varies with options)



TO DRAIN HYDRAULIC OIL

HYDRAULIC OIL FILTERS

Change hydraulic oil filters after the first 10 hours of operation and every 300 hours thereafter.

- Filter (A) is located at right side of engine compartment, under side panel.
- Filter (B) is located just ahead of frame cross channel, near hydrostatic pump.

To change:

1. Clean around the filter head.
2. Remove the filter element and clean the gasket surface of the filter head.
3. Apply a thin film of clean oil to the gasket on the new filter.
4. Install new filter. Turn the filter onto the mount until the gasket contacts the filter head. Tighten the filter an additional 1/2 to 3/4 turn by hand.

IMPORTANT: Do not use a filter wrench to install the oil filter. Over-tightening can damage gasket and filter.

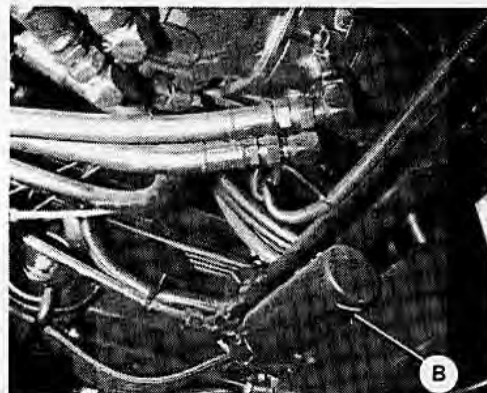
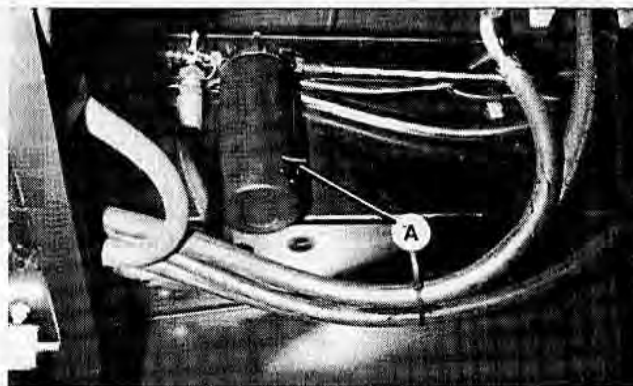

HYDRAULIC OIL FILTERS

MAINTENANCE/SERVICE

Hydraulic System: Header & Reel Lift

CYLINDER CONTROL VALVE RELIEF PRESSURE

Control valve (A), located under the R/H tractor floorboard, directs hydraulic flow to the header lift cylinders, reel lift cylinders and the cylinder used to engage the clutch for the sickle drive.

The control valve relief pressure is pre-set to be sufficient for all header sizes and options. Should lift capacity problems develop, check and adjust cylinder control valve relief pressure as follows:

1. Lower header and reel fully, stop engine and remove key from ignition.
2. The same relief valve protects both the header and reel lift circuits. It is most convenient to check relief pressure in the reel lift circuit.
For tractors with reel lift hydraulics, reel lift quick coupler (B) is located at left hand leg.
For tractors without reel lift hydraulics, the header lift circuit may be tapped at Port "C" of the lift valve. Remove hose (C) to access port.
3. Attach a 3000 psi (20 MPa) pressure gauge to a hose that is long enough to allow pressure to be read from the operator's seat. Attach hose to quick coupler or valve (see step 2) and position the gauge to be visible from the seat.
4. Start engine and position throttle lever fully back (low idle). Activate the lift control for the circuit you have tapped (reel or header) and check gauge pressure reading.
5. Pressure should be 1800 to 2100 psi (12.4 to 14.5 MPa). If not, proceed with adjustment:
6. Lower header and reel fully. Stop engine and remove key.
7. To adjust relief setting:
 - Loosen jam nut at relief valve (D).
 - Turn the adjustment screw in 1/4 turn increments, clockwise to increase relief pressure, counter-clockwise to decrease.

NOTE: 1/4 turn = approx. 80 psi change

8. Repeat checking and adjustment until relief pressure is correct, then tighten jam nut at (D).

IMPORTANT: If relief pressure does not increase after adjusting the screw two or three times, check relief valve as follows: Remove relief valve (D) from control valve block. Check that no contaminant is preventing the spring-loaded poppet from properly seating against the valve body. Clean as required, and reinstall valve. Reset adjustment screw to original position before checking relief pressure.

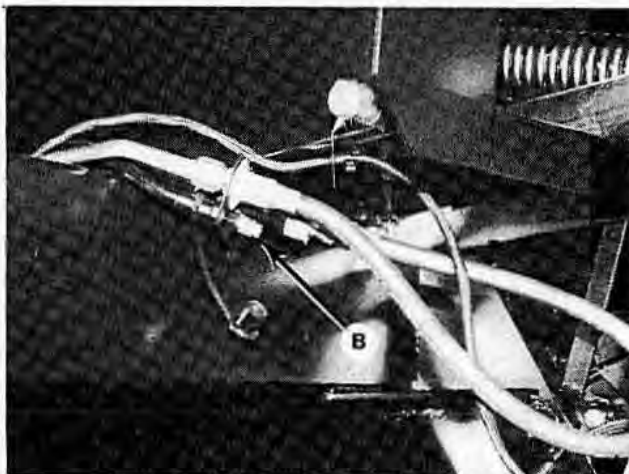

REEL LIFT QUICK COUPLER

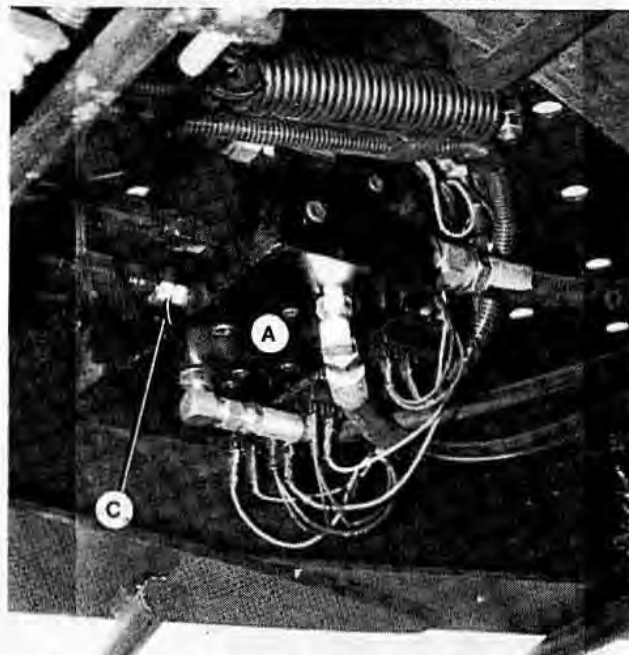

CYLINDER CONTROL VALVE (FRONT VIEW)

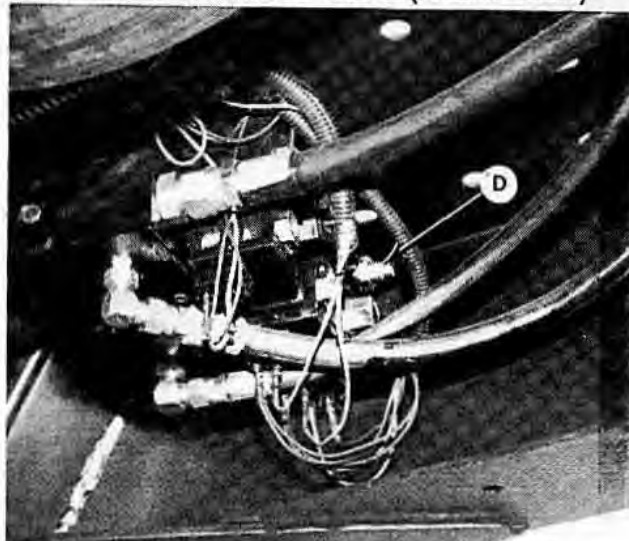

CYLINDER CONTROL VALVE (REAR VIEW)

MAINTENANCE/SERVICE

Header & Reel Lift: Hydraulic Schematic

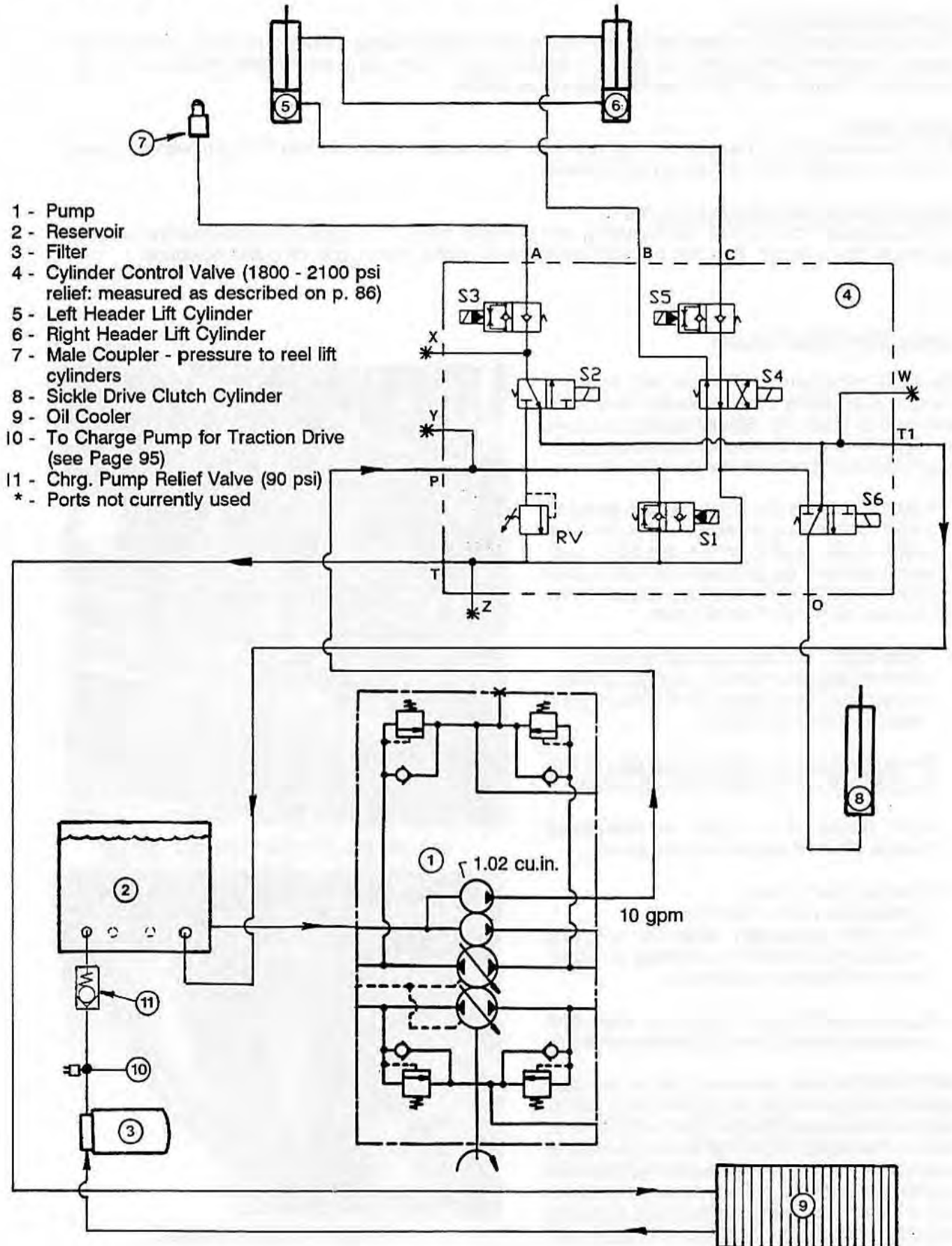

MAINTENANCE/SERVICE

Header Drive: Hydraulics

FLOW CONTROL BLOCK

Flow control block (A), located under cab near ground speed linkage, provides hydraulic power to the header. The block divides pump output of 17.5 gallons per minute (gpm) and controls the flow of oil into two circuits. Flow is used by the various headers as follows:

Auger Header

Both circuits combine to supply oil to the reel drive. Flow can be varied from 6 to 17.5 gpm with either reel or conveyor speed control knob on cab console.

Harvest Header and Multi-Crop Header

The flow to each circuit (reel and conveyor) can be varied from 3 to 9 gpm. If one flow control is set at maximum flow (9 gpm), the other control must be set no higher than 8 gpm for stable operation.

Header Drive Relief Pressure

Overload protection for the reel and conveyor drives is provided by an internal relief valve in the flow control block (A). Should stalling problems develop with one of the header hydraulic circuits, check and adjust relief pressure as follows:

1. Attach a 3000 psi (20 MPa) pressure gauge to a hose that is long enough to allow pressure gauge to be read from the operator's seat. Attach pressure gauge hose to female coupler (E) at the tractor right hand leg and position the gauge to be visible from the seat.
2. • Start engine and run at operating speed.
• Move header drive switch to engaged position.
• Adjust reel speed control to minimum. (Reel should be turning slowly.)
3. Pressure should be 1900 to 2150 psi (13.1 to 14.8 MPa). If not, proceed with adjustment:
4. Move header drive switch to disengaged position. Shut off engine and remove key.
5. To adjust relief setting:
 - Loosen jam nut at relief valve (B).
 - Turn the adjustment screw in 1/4 turn increments, clockwise to increase pressure, counter-clockwise to decrease.
6. Repeat checking and adjustment until relief pressure is correct, then tighten jam nut at (B).

IMPORTANT: If relief pressure does not increase after adjusting the screw two or three times, check relief valve as follows: Remove relief valve (B) from flow control block. Check that no contaminant is preventing the spring-loaded poppet from properly seating against the valve body. Clean as required, and reinstall valve. Reset adjustment screw to original position before checking relief pressure.

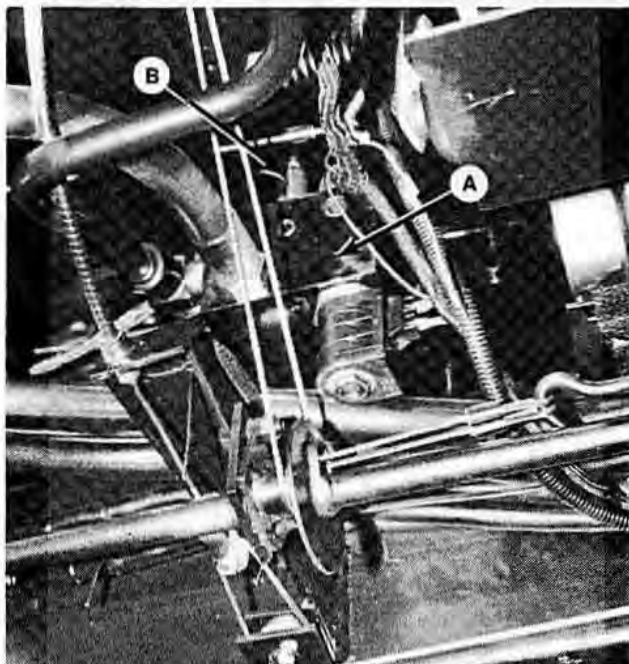

HEADER DRIVE FLOW CONTROL BLOCK

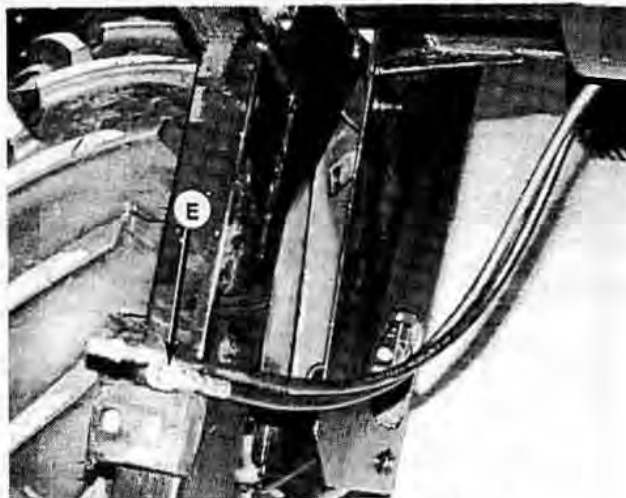

ATTACH PRESSURE GAUGE

MAINTENANCE/SERVICE

Header Drive: Hydraulic Schematic

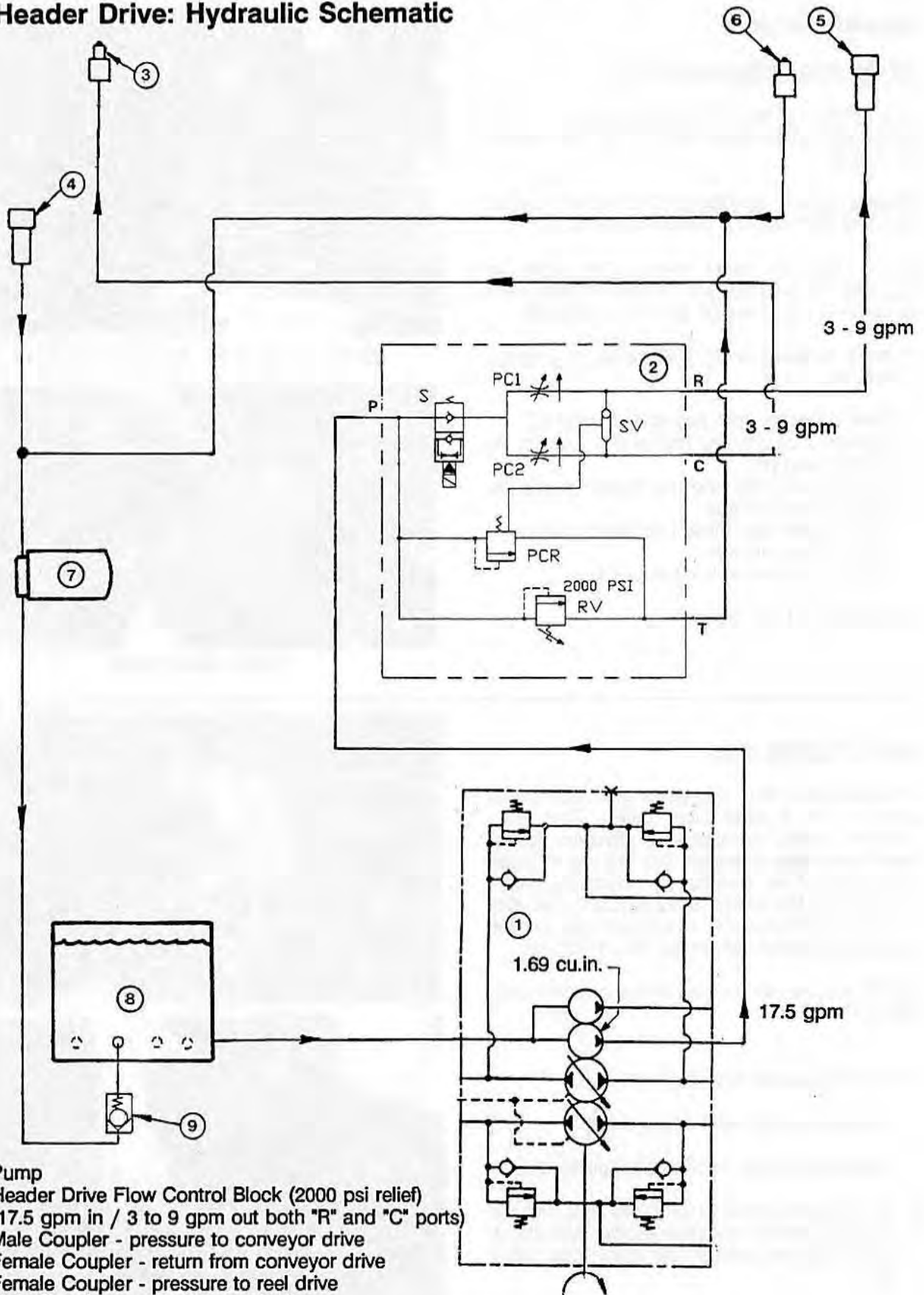

- 1 - Pump
- 2 - Header Drive Flow Control Block (2000 psi relief)
(17.5 gpm in / 3 to 9 gpm out both "R" and "C" ports)
- 3 - Male Coupler - pressure to conveyor drive
- 4 - Female Coupler - return from conveyor drive
- 5 - Female Coupler - pressure to reel drive
- 6 - Male Coupler - return from reel drive
- 7 - Filter
- 8 - Reservoir
- 9 - Check Valve

MAINTENANCE/SERVICE

Header Drive

BEVEL GEAR BOX LUBRICANT

The bevel gear box directs power from the main drive train to the header drive at the right side of the tractor.

Recommended Lubricant: SAE 85W-140 gear lubricant (API Service Classification GL-5).

Check lubricant level every 200 hours or annually. Check level with engine stopped. Add lubricant at filler location (A) to level plug (B).

Change lubricant every 1000 hours or 3 years, as follows:

1. Drain lubricant from box at drain plug (C).
2. Replace plug (C), and refill at filler location (A) to level plug (B).
3. Replace plug (B) and run engine at idle for two or three minutes.
4. Stop engine and allow lubricant to settle for two or three minutes.
5. Top-up lubricant to level plug (B).

CAPACITY - 1 US quart (1 L)

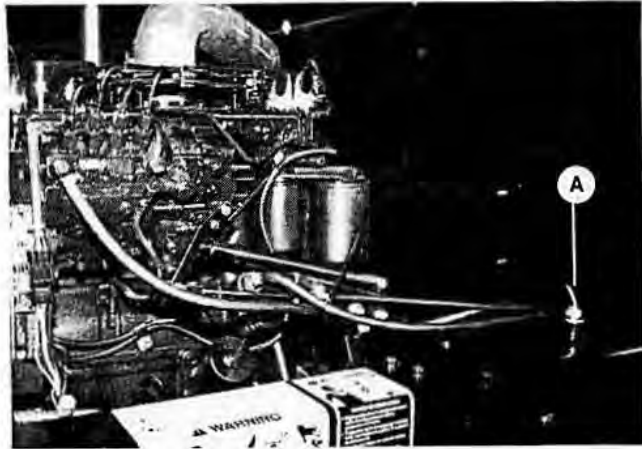

BEVEL GEAR BOX - FILLER LOCATION

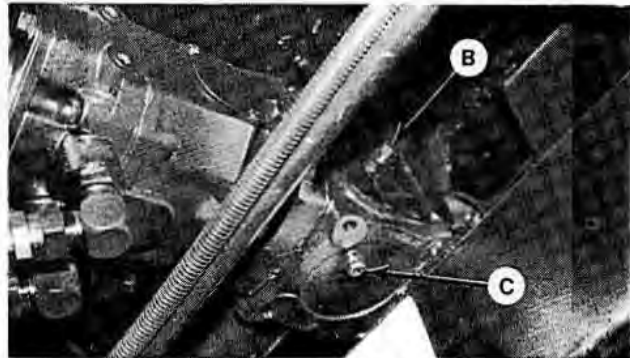

BEVEL GEAR BOX

HEADER DRIVE BELT

This belt runs from the bevel gear box output shaft to the header drive pulley. This drive provides power (through the driveline) for all mechanical header drives. The drive is engaged by means of an electric over hydraulic clutch activated by the header drive switch in cab. Belt tension is maintained by a hydraulic cylinder and manual adjustment of tension is not required.

NOTE: Engine will not start if header drive belt is engaged.

To remove header drive belt:

1. Remove header drive pulley shield.
2. Remove belt from header drive pulley (A).
3. At rear pulley, remove hardware at (C), loosen the lower guide and remove lower belt strand. Bring belt up between top guide and pulley (B).

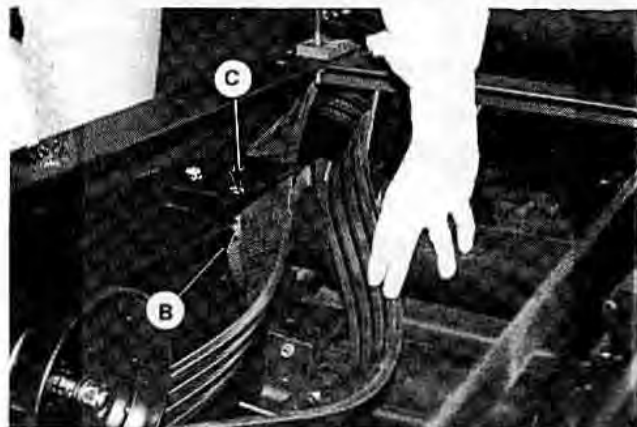
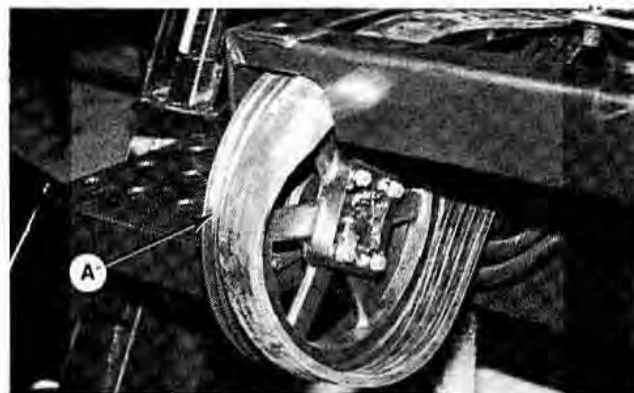

REMOVING HEADER DRIVE BELT

MAINTENANCE/SERVICE

Header Drive

HEADER DRIVE BELT: PULLEY FORE-AFT ALIGNMENT

Fore-aft misalignment of pulleys can cause a belt failure where the backing band splits between V-belt sections, as shown at (A).

Check and correct the pulley fore-aft alignment in the following order:

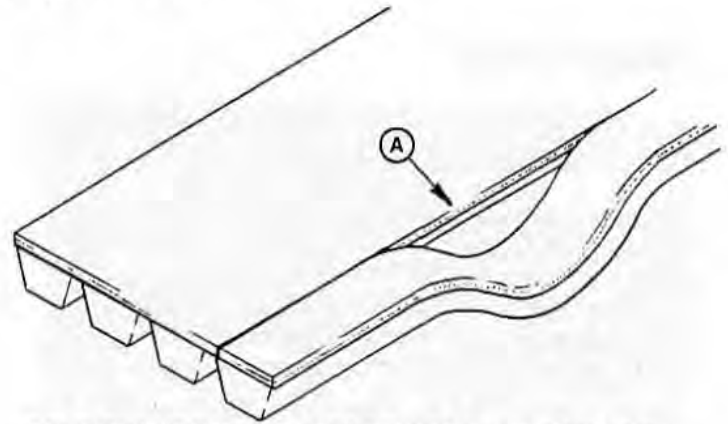

BELT FAILURE DUE TO FORE-AFT MISALIGNMENT

1. Rear pulley must be square to frame as shown. To check, place a straight edge along side of rear pulley and check that clearance to frame at (L) and (M) is equal. To adjust, loosen nut (N) and move R/H gearbox mount forward or back to square rear pulley. Tighten nut (N) to secure the position.

NOTE: Dimension at (L) and (M) should be approximately 17 mm (0.67"), but never less than 13 mm (0.51") to allow for removal and installation of drive belt.

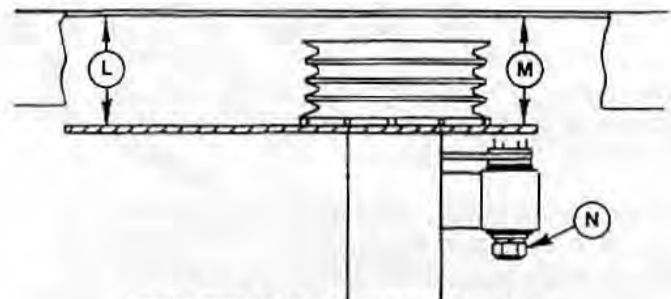

REAR PULLEY SQUARE TO FRAME

2. Rear pulley must align with front pulley as shown below. To check, place a straight edge along side of rear pulley and check that dimension (C) at front pulley is 6 mm (0.24"). To adjust, loosen taper lock bushing (T) at rear pulley and move pulley on gearbox shaft. Ensure that pulley hub or bushing does not contact gearbox seal. Tighten bushing (T) to secure the position.

NOTES: • If (C) is different than (D), see step 4.

• If 6 mm dimension can not be achieved by moving bushing (T), go back to step 1 and purposely misalign rear pulley with frame to obtain 6 mm dimension at (C). Then proceed with steps 3 and 4.

3. Flat idlers must align with each other as shown. Dimension (F) must equal dimension (G) within 2 mm (0.08"). To adjust idlers, bend mounting arms to suit. (It may be necessary to heat idler arms to permit adequate bending.)

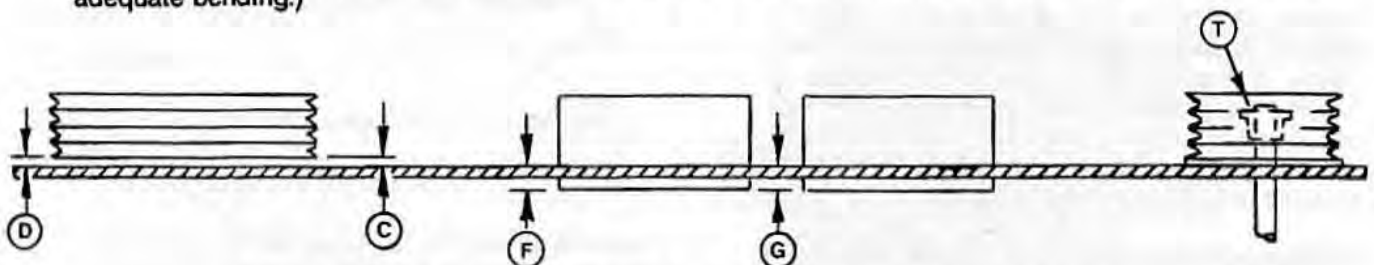

REAR PULLEY ALIGNED WITH FRONT PULLEY AND IDLERS ALIGNED

4. Front pulley must be square to rear pulley as shown. To check, place a straight edge along side of front pulley and check that dimension (E) is 6 mm (0.24"). To adjust, shim front pulley mounting plate at both front bolts, or both rear bolts so that dimensions (C), (D) and (E) are all 6 mm (0.24").

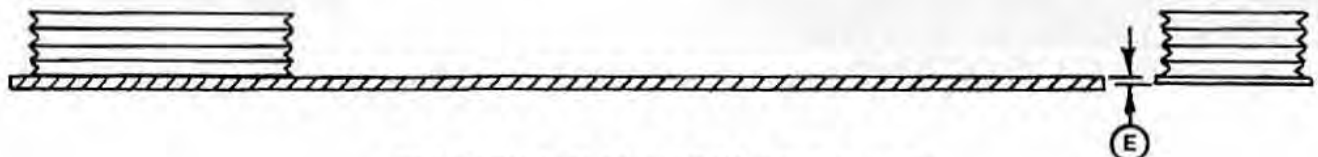

FRONT PULLEY SQUARE TO REAR PULLEY

MAINTENANCE/SERVICE

Traction Drive: Hydraulics

TRANSMISSION OIL PRESSURE

Warning light and buzzer in cab will be activated when ignition switch is turned ON if transmission oil pressure is below approximately 40 psi (275 kPa). Do not drive the windrower until light and buzzer go off. If light and buzzer stay on after engine starts, or if they activate during operation, shut engine off and check hydraulic oil level at reservoir. If oil level is adequate, measure charge pump pressure as described below.

CHARGE PUMP PRESSURE

The charge pump provides hydraulic power to the traction drive. To check charge pump pressure:

1. Remove wiring from oil pressure switch near hydraulic oil filter at right side of engine compartment. Remove switch (A) from cross fitting.
2. Attach a 0 - 600 psi (4000 kPa) pressure gauge to a hose that is long enough to allow pressure gauge to be read from the operator's seat. Attach hose to the cross fitting (A) (1/4 NPT).
3. Start engine and move throttle lever fully forward. Pressure should be 90 to 150 psi (620 to 1000 kPa).
4. If pressure is not within this range, back pressure relief valve (B) at reservoir is defective. To replace relief valve, it will be necessary to drain hydraulic oil. See "Changing Hydraulic Oil" on page 85.

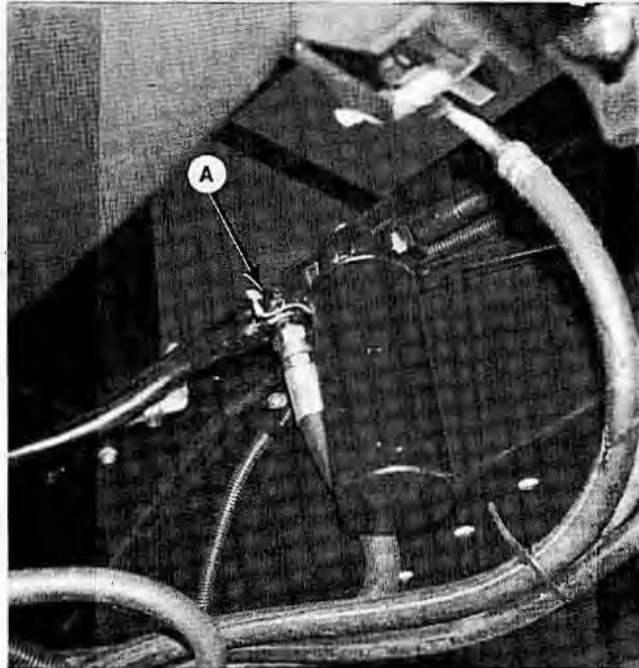

ATTACH HOSE FROM PRESSURE GAUGE

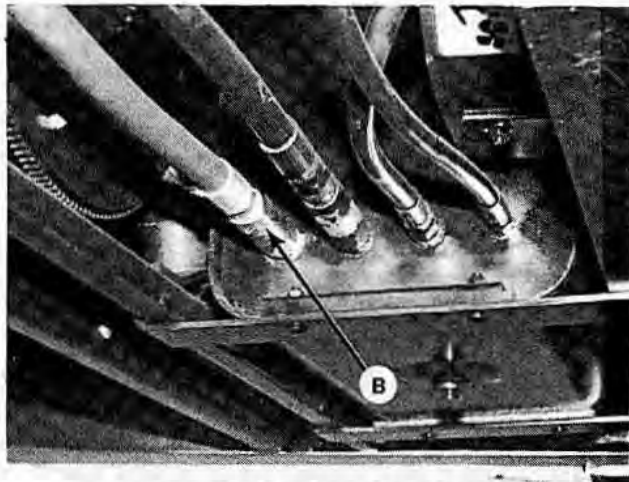

CHECK VALVE AT RESERVOIR
CONTROLS CHARGE PUMP PRESSURE

MAINTENANCE/SERVICE

Traction Drive: Hydraulic Schematic

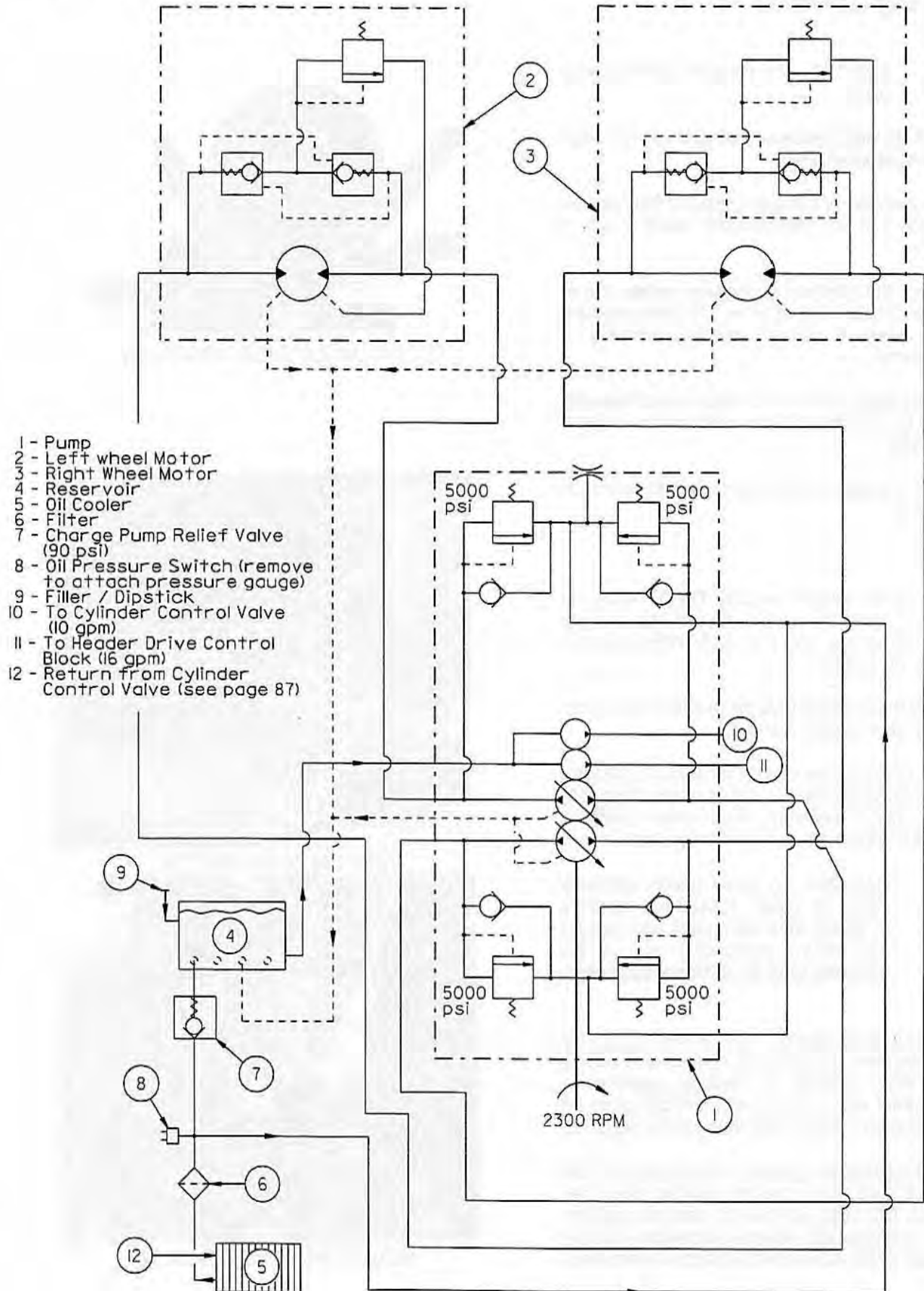

MAINTENANCE/SERVICE

Traction Drive: Neutral Lock and Steering Checks



DANGER: To prevent machine runaway:

- **STOP ENGINE** before adjusting steering linkage or neutral interlock.
- Never rewire or misadjust neutral interlock so engine can be started with controls out of neutral.
- Never start engine by shorting across starter terminals. Machine will start with drive engaged and move if normal starting circuitry is bypassed.
- Start engine only from operator's seat. Never try to start engine with someone under or near machine.
- Refer to proper start-up procedure in Operation section.
- The starter should engage ONLY when the ground speed lever is in neutral, the steering wheel is locked, and the header drive switch is in the off position.
- Under these conditions, the machine should not move after engine start-up.

If either of the above does not hold true, perform the following nine checks. Adjustments, if required are described following each check point. A troubleshooting section follows the check list.



DANGER: To avoid severe personal injury or death caused by machine runaway, shut off engine and remove key before performing any of the following checks and/or adjustments.

1. **Neutral Start Switch:** Check that electrical connections are good at neutral start switch (A). With controls in start-up position as described above, plunger of switch must be compressed. Adjust switch support if required.
2. **Header Drive Belt Switch:** Check that electrical connections are good at header drive belt switch (R). With controls in start-up position, (belt disengaged), plunger of switch must be compressed. Adjust switch support if required.



FOLLOW ADJUSTMENT PROCEDURE

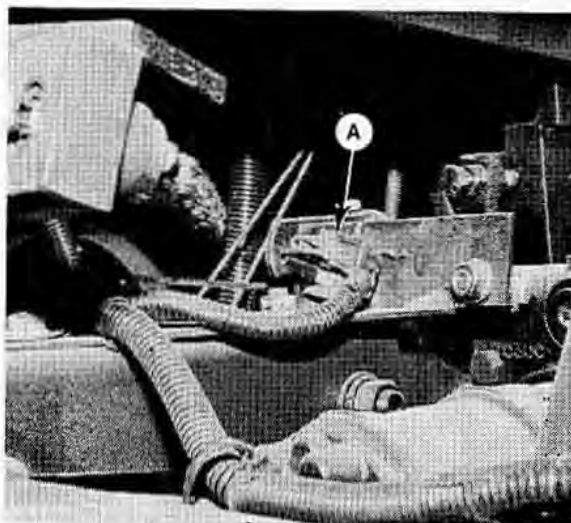

NEUTRAL START SWITCH

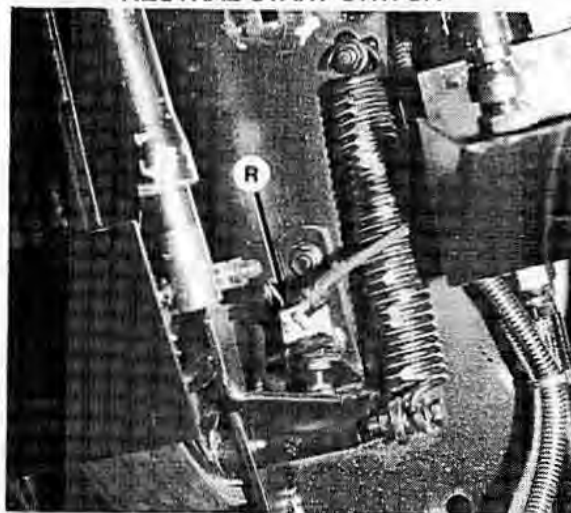

HEADER DRIVE BELT SWITCH

MAINTENANCE/SERVICE

Traction Drive: Neutral Lock and Steering Checks (continued)

3. **Neutral Lock Adjustment Bolts Engagement:** Check the depth of engagement of the neutral lock adjustment bolts (B) on pintle arms (C). Minimum engagement is 3/8 inch (10 mm), that is, the full diameter of the bolt must contact pintle arms.

To adjust:

- Loosen cable as described in check 4, below.
- Adjust neutral start switch to obtain proper engagement depth.
- Readjust cable as described in check 4.



WARNING: Do not adjust the neutral lock adjustment bolts (B). These bolts can only be adjusted during neutral set-up procedure described at the end of this section.

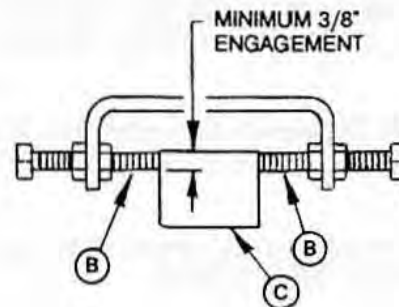

ENGAGEMENT DEPTH:
NEUTRAL LOCK ADJUSTMENT BOLTS

4. **Cable Tension:** Check tension of cable (D). The cable should be tight when the ground speed lever (F) is at the right hand side of the neutral detent on side console, and when the neutral start switch is fully compressed. If the cable is too tight, it will prevent the neutral start switch from fully compressing.

To adjust cable tension, loosen nut (H) on threaded hook bolt (E) and turn nut (J) clockwise to increase cable tension, counter-clockwise to decrease. Tighten nut (H) against nut (J) to secure the position.

5. **Ground Speed Lever Pivot:** Check the pivot at ground speed lever (F). Nut (L) should be flush with the end of the carriage bolt (full thread engagement). To tighten, hold nut (K) with a wrench and tighten nut (L) against nut (K). Torque nut (L) to 60 to 70 ft.lbs. (80 to 90 N-m).

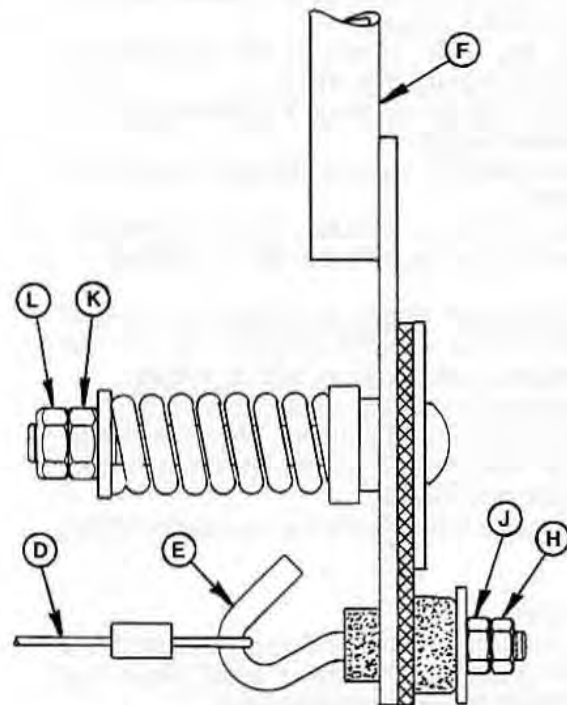

GROUND SPEED LEVER CONNECTIONS

MAINTENANCE/SERVICE

Traction Drive: Neutral Lock and Steering Checks (continued)

6. Radius Arm Pivots: Check the two pivots (A) and (C). At each pivot, torque inner nut (D) to 7 ft.lbs. (10 N·m). Hold inner nut (D) with a wrench and tighten outer nut (E) against nut (D). Torque nut (E) to 60 to 70 ft.lbs. (80 to 90 N·m).

IMPORTANT: Be sure to hold inner nut (D) while tightening outer nut (E). Nut (D) MUST NOT TURN.

At ball joint connection (B), torque both nuts to 60 to 70 ft.lbs. (80 to 90 N·m).

7. Ground Speed Lever Position: Check that when the steering wheel is locked, the ground speed lever (F) is centered fore-aft in the neutral detent on side console as shown.

To adjust:

- Loosen bolts (G) (see photo above), allowing bolts to slide in slots.
- Lock the pintle arms in the neutral lock adjustment bolts. See check 3.
- Hold ground speed lever (F) centered fore-aft in neutral detent.
- Have a second person tighten bolts (G) as follows:
 - inner nut: 80 to 90 ft.lbs. (110 to 120 N·m)
 - outer nut: 60 to 70 ft.lbs. (80 to 90 N·m)

8. Neutral Lock Structure: Check for proper movement of support structure (J) for the neutral lock adjustment bolts as follows:
- Disconnect spring (P) to unload pivots.
 - Check that support structure (J) rotates freely.
 - Check that there is no fore-aft movement of support structure (J).
 - If no adjustment is required, reconnect spring (P).

To adjust:

- Turn nut (K) until the washer just contacts the plastic bushing. This pivot must allow free rotation of the support structure.
- Turn nut (L) until the washer contacts the front support. Check again for free rotation of the structure with no fore-aft movement. To lock, hold inner nut (L) with a wrench and tighten outer nut (M) against nut (L). Torque nut (M) to 60 to 70 ft.lbs. (80 to 90 N·m).
- Reconnect spring (P).

9. Loose Hardware: Check all hardware (not included in the previous checks) is properly tightened to torque specifications on ground speed controls, control rods, pump pintle arms and neutral start mechanisms.

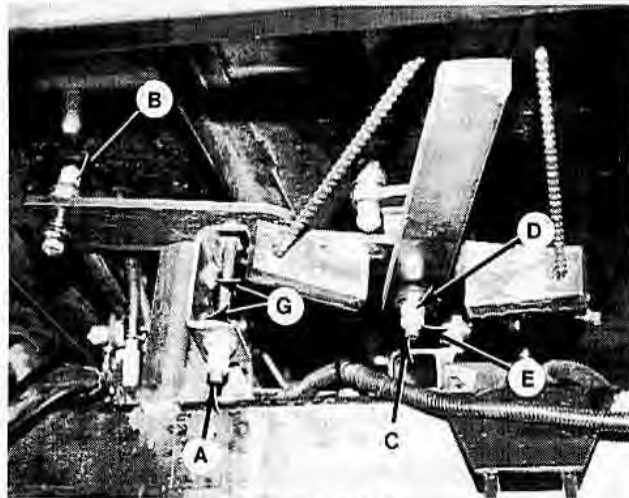

RADIUS ARM

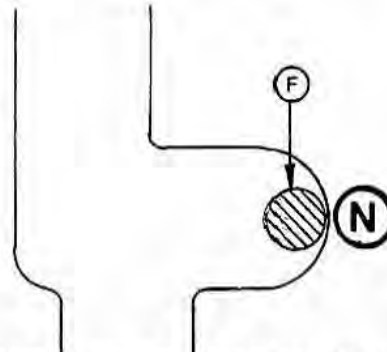

GROUND SPEED LEVER - NEUTRAL DETENT

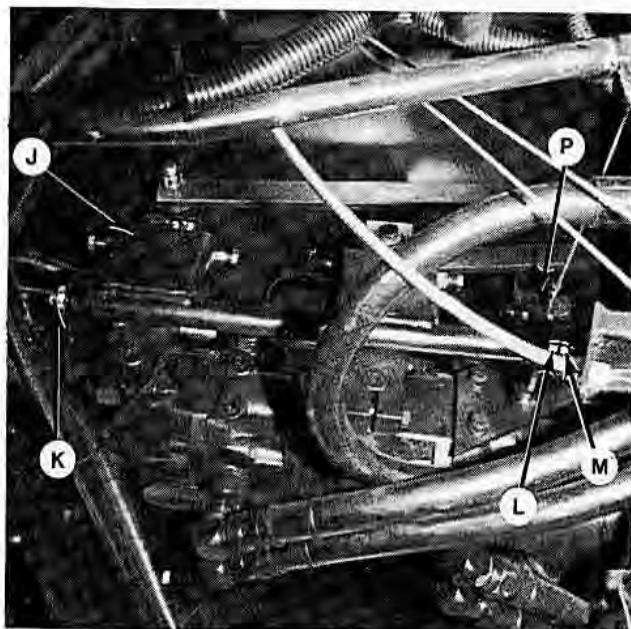

NEUTRAL LOCK STRUCTURE

MAINTENANCE/SERVICE

Traction Drive: Neutral Lock and Steering Troubleshooting

Any problem with the neutral lock and steering controls could be caused by loose, worn, or improperly adjusted parts as described in the preceding nine checks.

IMPORTANT: When servicing this area, it is important to perform all of the nine checks to avoid missing the problem and providing only a temporary fix.

PROBLEM: Steering wheel will not lock in neutral.
TRY CHECK #: 7, 4, 8

PROBLEM: Ground speed lever will not go into reverse or forward.
TRY CHECK #: 4

PROBLEM: Ground speed lever rattles in neutral.
TRY CHECK #: 4, 8

PROBLEM: Ground speed lever not spring loaded towards the center of forward travel slot.
TRY CHECK #: 4, 8

PROBLEM: Steering wheel locks in neutral, but neutral start switch does not compress.
TRY CHECK #: 1, 3, 4, 7, 8. If problem persists, perform "Neutral Set-Up Procedure", next page.

PROBLEM: Machine "growls" severely or moves after engine start up.
TRY CHECK #: 1 - 9. If problem persists, perform "Neutral Set-Up Procedure", next page.

PROBLEM: Steering wheel locks in neutral only after several left to right rotations of wheel.
TRY CHECK #: 3, 4, 7, 8. If problem persists, perform "Neutral Set-Up Procedure", next page.

MAINTENANCE/SERVICE

Traction Drive: Neutral Set-Up Procedure

This procedure should be performed only after the nine preceding checks and adjustments have failed to solve the neutral lock/steering problem.

This procedure will eliminate machine movement in neutral and will improve neutral locking ability.



CAUTION: Use jack-stands with a minimum capacity of 3 tons (2720 kg) to provide adequate support for machine.



DANGER: Never attempt neutral set-up procedure without raising front wheels off the ground so they are free to turn. Failure to raise front wheels will result in machine runaway, causing severe personal injury or death.

1. Detach header and remove hay conditioner forming shields from under tractor.
2. Raise front of machine high enough to allow both wheels to turn freely and support with jack-stands. See "Jacking Procedure" under Wheel & Tire Maintenance in this section.
3. Start engine and idle at approximately 1200 - 1500 RPM.
4. Set controls as follows:
 - Ground speed lever in neutral.
 - Steering wheel locked.
 - Park brake disengaged.

5. Loosen bolts (A), allowing the bolts to slide freely in slots.

NOTE THE FOLLOWING:

- Front pintle arm (B) controls the left wheel and rear pintle arm (C) controls the right wheel.
 - Moving the pintle arms towards the front causes the wheels to turn forward. Moving the pintle arms rearward causes the wheels to turn in reverse.
 - The pintle arms are located in neutral when they are between the forward and reverse positions. The neutral lock adjustment bolts (D) are used to position the pintle arms in the neutral range.
 - Each neutral lock adjustment bolt has a jam nut (E). Always hold bolt (D) with a second wrench when loosening or tightening jam nut (E) so pintle arm positions are not lost.
6. Loosen jam nuts on bolts (D) and turn bolts in and out to find the neutral position of each pintle arm, that is, the position where drive wheels are not turning. Finger tighten bolts (D) against pintle arms.



FOLLOW ADJUSTMENT PROCEDURE

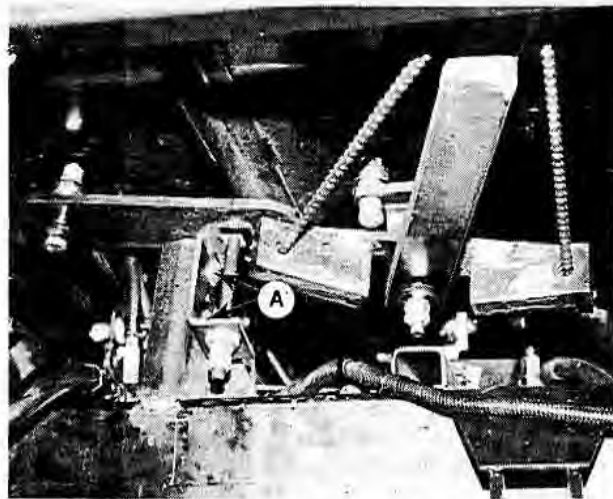

STEERING CONTROLS

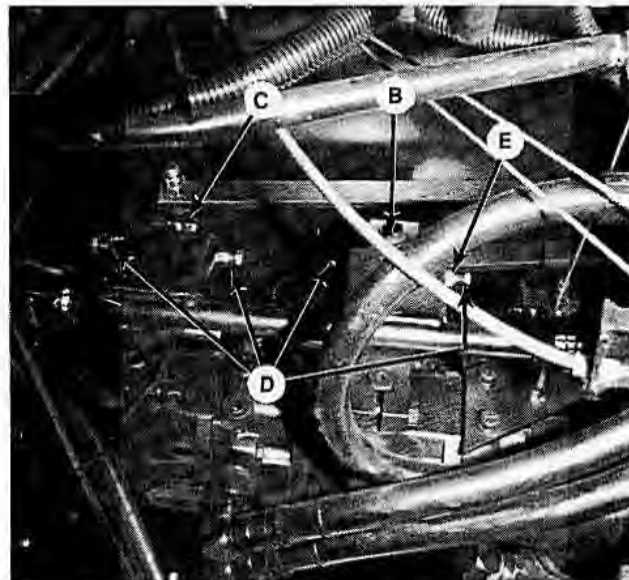

NEUTRAL LOCK

MAINTENANCE/SERVICE

Traction Drive: Neutral Set-Up Procedure (continued)

7. The following adjustment is designed to give the maximum clearance between the neutral lock adjustment bolts and the pintle arms without having the wheels turn. This results in easy locking of the steering wheel into the neutral position.

Perform this adjustment for each of the four neutral lock adjustment bolts, starting at the rear bolt and working towards the front. **Remember:** Rear pintle arm controls right wheel, front pintle arm controls left wheel.

- Have a second person grasp the front steering pivot (F) and continuously rotate it back and forth while you slowly turn adjustment bolt counter-clockwise (away from pintle arm). Find the maximum clearance position without having the wheel turn.
 - Hold bolt with a wrench and tighten jam nut to secure the position.
 - Repeat clearance adjustment until all four bolts are properly positioned.
8. Shut off engine and remove key.
 9. Adjust ground speed lever to center of neutral detent. See Check #7 on page 96.
 10. Repeat steps 5 to 9 if required.
 11. Lower drive wheels to ground.

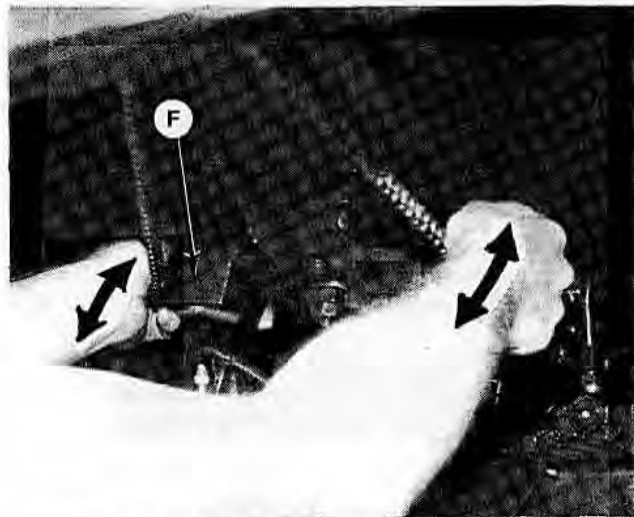

NEUTRAL LOCK ADJUSTMENT BOLTS
CLEARANCE ADJUSTMENT

Traction Drive: Ground Speed Lever Friction Device Adjustment

The ground speed lever friction device maintains lever position at the point in the forward/reverse slot where it was released by the operator.

The friction device is located at the bottom of the ground speed lever (A), under the cab. It has been factory set as shown, where lock nut (B) is 0 to 1/8 inch (0 to 3 mm) from the end of the carriage bolt.

If the lever does not maintain its position in hilly or soft-soil conditions it may be desirable to increase the holding ability of the friction device.

NOTE: Increasing the holding ability of the friction device also increases the amount of force required by the operator to move the ground speed lever.

To increase friction device holding ability:

1. Tighten nut (C) until it "bottoms-out" on the threads at point (D).
2. Hold nut (C) with a wrench and tighten lock nut (B) against nut (C). Torque nut (B) to 60 - 70 ft.lbs. (80 - 90 N·m)

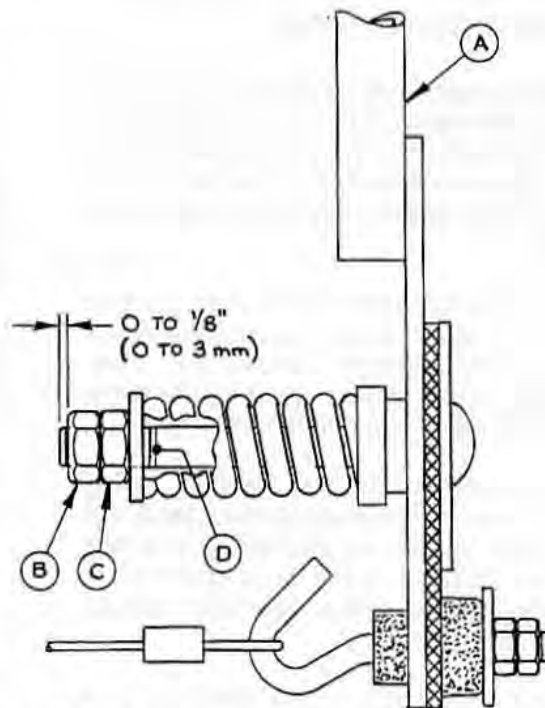

GROUND SPEED LEVER FRICTION DEVICE
(REAR VIEW)

MAINTENANCE/SERVICE

Traction Drive: Dual-Speed Linkage

See "Speed Range Control" in Operator's Station section for lever operation details. Following is troubleshooting and adjustment information on the dual-speed linkage:

PROBLEM: Lever does not stay in low (field speed) range, but is OK in high (road speed) range.

POSSIBLE CAUSES:

- Loose cable. See Adjustment #1.
- Lever hits console before cam hits stop bolt (A). See Adjustment #2.
- Lever travel not obstructed, motor linkage requires adjustment. See Adjustment #3 & 4.

PROBLEM: Lever does not stay in high range.

POSSIBLE CAUSES:

- Loose cable. See Adjustment #1.
- Motor linkage requires adjustment. See Adjustment #3 & 4.

ADJUSTMENT #1 To adjust cable tension:

- Loosen nut (F) on hook bolt (J) and turn nut (G) clockwise to increase cable tension, counter-clockwise to decrease tension. Cable tension is correct when it can be pinched together at mid-span (P) with finger force. Do not over tighten.

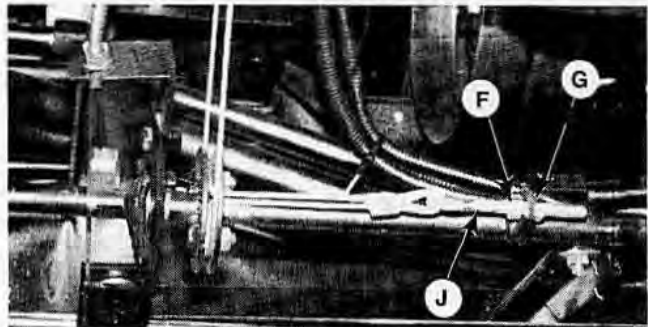

CABLE TENSION

ADJUSTMENT #2 To adjust lever travel:

- Pull lever rearward until stop hits bolt (A). Top portion of lever should be vertical.
- If not, loosen bolt (C) and shift lever forward to high range until stop hits bolt (B).
- Push lever an additional 2 to 3 inches (50 -75 mm) forward. This will allow cable to slip around bolt (C)
- Tighten bolt (C) and pull lever back to low range until stop hits bolt (A). If top portion of lever is still not vertical, repeat the procedure.

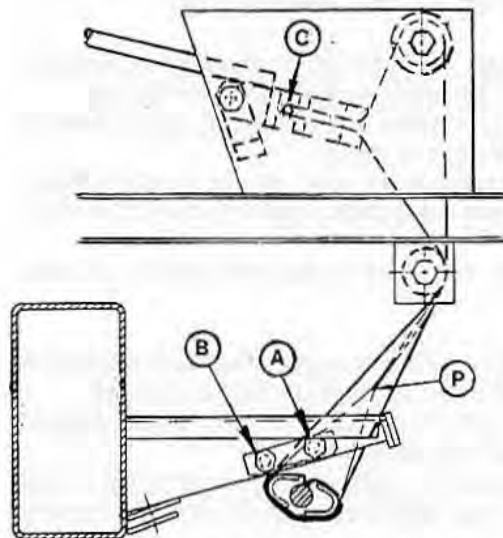

CABLE ROUTING & LEVER TRAVEL

MAINTENANCE/SERVICE

Traction Drive: Dual-Speed Linkage (continued)

ADJUSTMENT #3 To adjust motor clevis nuts:

NOTE: When shifting from low to high, L/H motor shift arm (M) moves upwards while R/H motor shift arm (L) moves downwards.

- Ensure bolts (K) are tight, then remove lock plate hardware (S). Loosen outer nuts (R) and clevis nuts (D) and (E) at both tractor legs.
- **R/H Leg:** - Rotate upper shaft away from bolt (A) until centerline of stop on shaft lines up with corner (N).
 - Hold R/H motor shift arm (L) up against internal stop in motor and finger tighten nut (D) against clevis. (This pulls upper shaft to bottom of slot in tractor leg.)
 - Lock this position by securely tightening top nut (E) against clevis.
 - Using two wrenches, tighten both outer nuts (R) simultaneously against nuts (D) and (E).
 - Replace lock plate hardware (S).
- **L/H Leg:** - Rotate upper shaft until centerline of stop on shaft lines up with corner (H).
 - Hold L/H motor shift arm (M) up against internal stop in motor and tighten nuts as done at R/H leg.

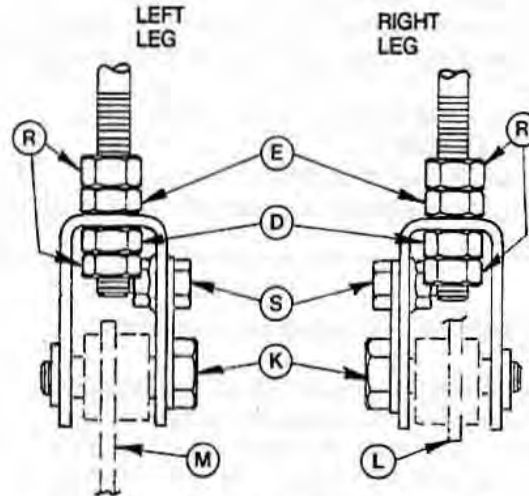

DUAL-SPEED LINKAGE CLEVIS NUTS

ADJUSTMENT #4 To adjust upper shaft stops:

- Loosen hardware securing upper shaft stops (P), at left and right ends of shaft.
- **L/H Side:** - Rotate upper shaft until centerline of stop on shaft lines up with corner (N).
 - Move L/H motor shift arm (M) down against internal stop in motor.
 - Pull down on left end of upper shaft (hand force only) and slide stop (P) down to contact shaft.
 - Tighten hardware to secure position of stop (P).
- **R/H Side:** - Rotate upper shaft until centerline of stop on shaft lines up with corner (H).
 - Move R/H motor shift arm (L) down against internal stop in motor.
 - Pull down on right end of upper shaft (hand force only) and slide stop (P) down to contact shaft.
 - Tighten hardware at stop (P).
- Cycle lever from low to high. There should be a noticeable "clunk" at both ends of lever travel as stop hits bolt (A) or (B). If not, repeat adjustments 3 and 4.

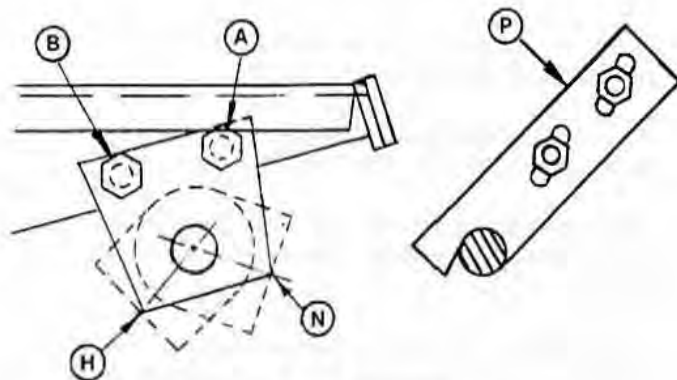

UPPER SHAFT STOPS

MAINTENANCE/SERVICE

Traction Drive: Wheels and Tires

POWER WHEELS

Check lubricant level every 200 hours or annually. See "Fuels, Fluids and Lubricants" for recommended lubricant.

To check level, position wheel so fill plug (B) is 1 inch (25 mm) above the wheel's horizontal, center line (C). Lubricant should be level with fill plug.

Change power wheel lubricant after the first 50 hours operation and every 1000 hours (or 3 years) thereafter. To drain lubricant, position wheel so plug (B) is at 6 o'clock position.

CAPACITY - 45 U.S. oz. (1350 mL)

IMPORTANT: Failure to disengage final drives before towing will result in serious transmission damage.



CAUTION: With final drives disengaged, the windrower may roll on a sloped surface. Before disengaging final drives, attach windrower to towing vehicle. After towing, engage drives and park brake before detaching from towing vehicle.

To disengage final drives, remove cover (A) (both wheels) and reverse. Install with dished button facing in. After towing, reverse covers again to re-engage final drives. See "Towing the Windrower".

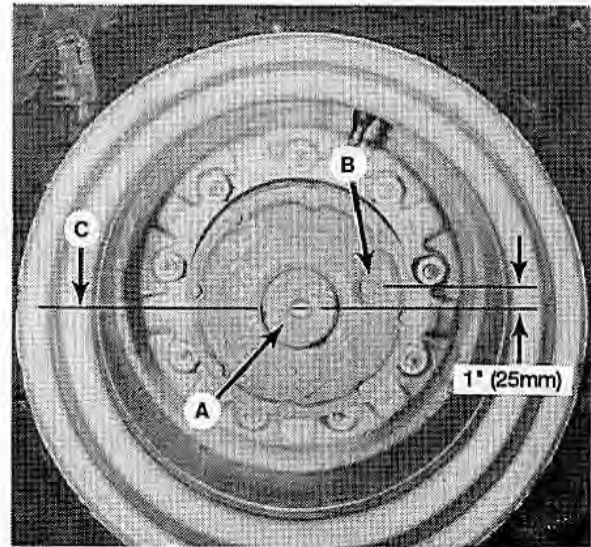

POWER WHEEL

WHEEL BOLTS

Check and tighten wheel nuts/bolts after the first 5 hours of operation and every 1000 hours thereafter.

Whenever a wheel is removed and re-installed, check torque after one hour of operation.

IMPORTANT: To prevent damage to wheel disc, do not over-tighten wheel nuts.

Maintain torque as follows:

Drive Wheel Nuts:

90 - 100 ft.lbs. (120 - 135 N·m)

Caster Wheel Bolts:

9.5L: 50 - 60 ft.lbs. (70 - 80 N·m)

16.5L: 90 - 100 ft.lbs. (120 - 135 N·m)

Follow the proper bolt tightening sequence shown at right.

NOTE: When installing drive tires, be sure air valves are on the outside and tire tread points forward.

For "Turf and Field" tires (diamond or rectangular tread), be sure arrow on sidewall points in forward rotation.

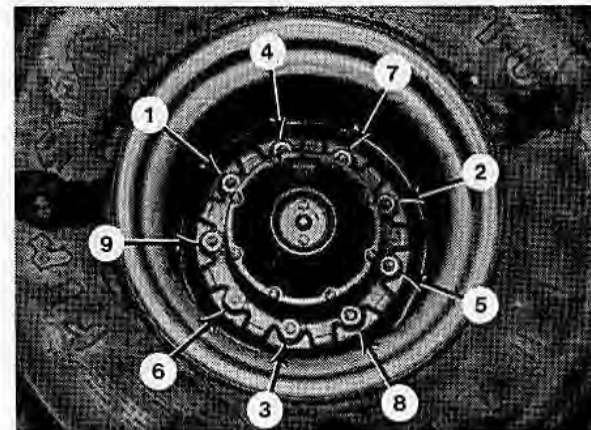

9-BOLT WHEEL
TIGHTENING SEQUENCE

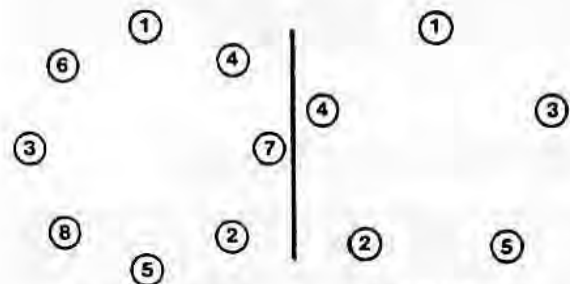

8-BOLT WHEEL 5-BOLT WHEEL
TIGHTENING SEQUENCE

MAINTENANCE/SERVICE

Traction Drive: Wheels and Tires

TIRE INFLATION

Make a visual check daily that tires have not lost pressure. Under-inflation of drive tires can cause side wall cracks.

Once a year, measure tire pressure with a gauge. Maintain the pressures recommended on page 12 (Specifications Section).



WARNING: Service tires safely. A tire can explode during inflation and cause serious injury or death.

Never increase air pressure beyond 35 psi (240 kPa) when seating the bead on the rim. Replace a tire if it has a defect. Replace a wheel rim which has cracks, wear or severe rust. Never install a tube in a cracked wheel rim. Never weld a wheel rim. Make sure all the air is removed from a tire before removing the tire from the rim. Never use force on an inflated or partially inflated tire. Make sure the tire is correctly seated before inflating to operating pressure.

Do not remove, install or make repairs to a tire on a rim unless you have the proper equipment and experience to perform the job. Take the tire and rim to a qualified tire repair shop. If the tire is not in correct position on the rim, or if too full of air, the tire bead can loosen on one side, causing air to leak at high speed and with great force. An air leak of this nature can thrust the tire in any direction, endangering anyone in the area.

(A) - Use a safety cage if available.

(B) - Do not stand over tire. Use a clip-on chuck and extension hose.

16.5 CASTER ANTI-SHIMMY SPRINGS

Maintain a spring length of 89 to 92 mm (3-1/2 to 3-5/8"). If necessary add 3/4 SAE flatwashers under spring to achieve this dimension. See Assembly section, page 132.

SHORTENING THE WHEEL BASE

The tractor unit's wheel base can be shortened from 128 inches (3244 mm) to 113 inches (2864 mm) by reversing the walking beam. This work should be done by a qualified dealer.



SERVICE TIRES SAFELY



JACKING PROCEDURE

Position jack or jack stand under bracket (C) welded to tractor frame legs, ensuring head of jack is secured by keeper rod.



JACK POSITION

MAINTENANCE/SERVICE

Traction Drive: Park Brake

The park brake is applied when brake lever (A) is locked in the up position.

Adjust park brake after the first 10 hours of operation and every 100 hours thereafter.

To increase brake force:

1. Move lever (A) down to release brake.
2. Turn knob (B) clockwise (towards the seat) until brake force is adequate. Force required to raise lever to the engaged position should be 70 to 90 lbs. (300 - 400 N).

NOTE: When brakes are approximately half worn, knob (B) will reach the end of the adjustment range. At this time, perform the following adjustment:

1. Turn knob (B) counter-clockwise (towards the side console), back to the beginning of the adjustment range.
2. At the rear of both tractor frame legs, remove locknut (C) and retaining bar (D). Move link (E) to welded bolt (F) and replace retaining bar and locknut.
3. Turn locknut (C) until the gap between the head of the welded bolt (F) and retaining bar (D) is $\frac{3}{8}$ inch (10 mm) as shown.
4. Turn knob (B) on brake lever clockwise until brake force is adequate. Force required to raise lever to the engaged position should be 70 to 90 lbs. (300 - 400 N).

NOTE: When installing new brake bands, return link (E) to original position, both sides, and adjust hardware as shown.

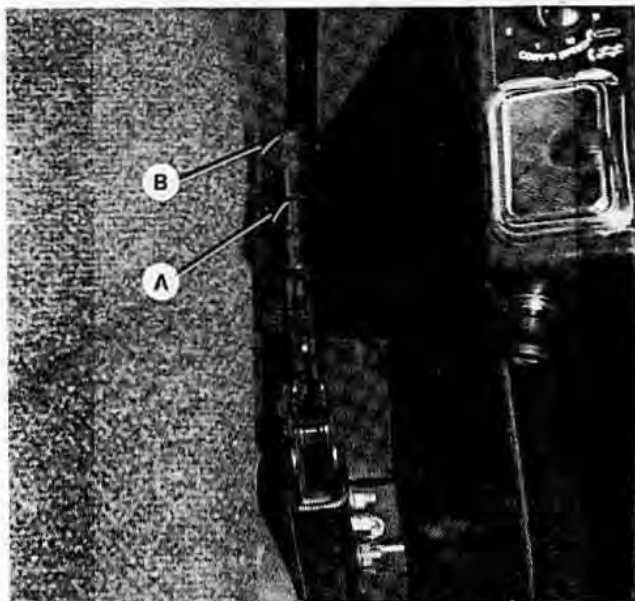

PARK BRAKE ADJUSTMENT

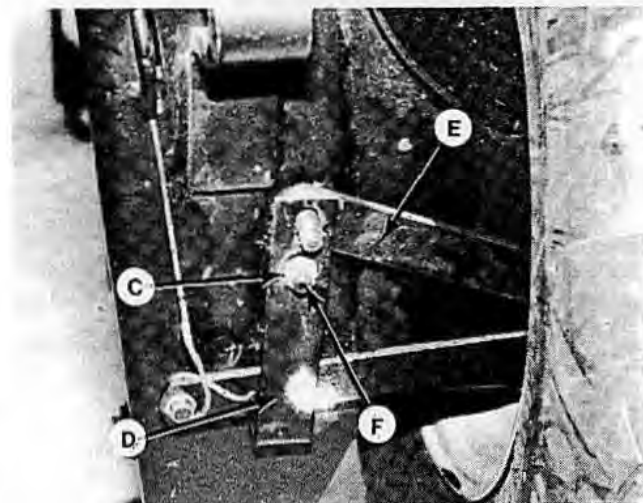

REPOSITION BRAKE LINK ON FRAME LEG AT HALF-WEAR STAGE

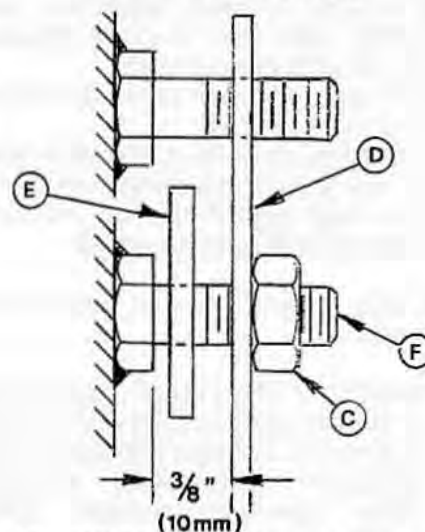

ADJUST BRAKE LINK HARDWARE

MAINTENANCE/SERVICE

Cab Air System



WARNING: The air conditioning system is pressurized. Improper servicing may cause refrigerant to penetrate eyes and skin or cause burns. Special equipment and procedures are required to service the air conditioning system. See your Windrower dealer for service.

If an accident involving refrigerant should occur, see a doctor familiar with this type of injury immediately.

CAB TEMPERATURE CONTROLS

See "Operator's Station" section for information regarding the use of the various controls affecting cab temperature.

AIR CONDITIONING CONDENSER

Clean daily with compressed air. See "Screens and Coolers" under cooling system maintenance.

FRESH AIR INTAKE FILTER

Clean daily as follows:

1. Loosen knob (A) and slide retainer out to release filter (B) from rear of cab roof.
2. Tap filter gently on a flat surface, dirty side down. Do not tap on a tire, treads may damage filter pleats.
3. Direct compressed air (100 psi [700 kPa] maximum) through filter in opposite direction of air flow arrows.
4. Wash filter as required:
 - Soak 15 minutes in warm water (not over 100°F [40°C]) with Filter Element Cleaner, (Donaldson D 1400 or equivalent).
 - Rinse thoroughly with clean water, (maximum pressure 40 psi [275 kPa]).
 - Shake excessive water from filter and allow element to dry. Do not use compressed air to dry filter; it may rupture the wet element. Protect element from freezing until dry.
5. Reinstall filter, making sure air flow arrows point towards cab.



CAUTION: The cab air intake filter is not designed to filter out harmful chemicals. Follow chemical manufacturer's instructions carefully when operating around spray areas.

NOTE:

1. The refrigerant utilized in this machine is R134a. Total system refrigerant capacity is 1.36 kg (3 lbs.). The compressor oil is SP-20 PAG. Total system oil requirement is 240 cc (8.1 U.S. fl.oz.). Oil is included in a new compressor.
To prevent premature system failure, do not use refrigerant R12 and/or its oil. Use of improper refrigerant or oil voids warranty.
2. Service must be performed by a qualified R134a technician only.

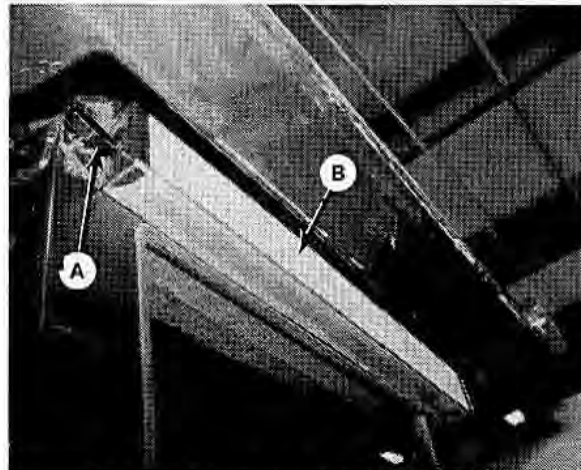

CAB FRESH AIR INTAKE FILTER



CLEANING AIR FILTER

MAINTENANCE/SERVICE

Cab Air System

RETURN AIR FILTERS

Clean return air filters every 100 hours, more often in dusty conditions.

To clean:

1. Remove filter covers at both sides of cab rear wall by removing two nuts (A).
2. Remove foam filter elements and clean with compressed air.
3. Replace filter elements and covers.

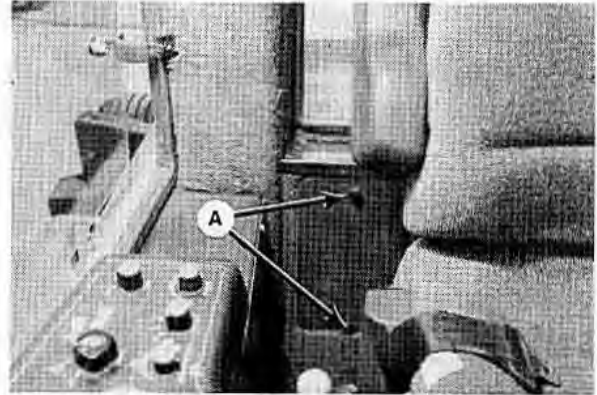

REMOVE FOR ACCESS TO RETURN AIR FILTER

EVAPORATOR CORE

If air conditioning system produces insufficient cooling, a possible cause is clogged evaporator fins. Fins will clog up starting at the back side of the evaporator core (against cab wall).



WARNING: To avoid cuts from evaporator fins, do not use bare hands to brush away clogs.

Evaporator core access and cleaning:

1. Remove R/H console panel (A).
2. Release air suspension to fully lower operator's seat. Tilt seat (B) forward while tilting seat-back (C) rearward until seat is vertical.
3. Lift the acoustical foam (E) at top of evaporator core and remove two nuts securing retainer (F). Remove retainer.
4. Tilt evaporator core forward and vacuum off back side of core (at cab wall). Use a fin straightener to loosen clogs.
5. Blow compressed air through core at an angle parallel to tubing alignment as shown. To prevent fin damage, blow air directly at fin edges, not at flat face.
6. If the compressed air can not be felt at the back of the core, proceed as follows:
 - Remove foam filter (D) from drain tray and clean with warm water.
 - With filter (D) still out, pour warm water down through the core and leave it to soak. (The drain tray will catch and remove run-off.)
7. Blow compressed air through the core as in step 5. Repeat warm water soaking as required until air blows through evaporator core freely.
8. Straighten any bent fins and reassemble.

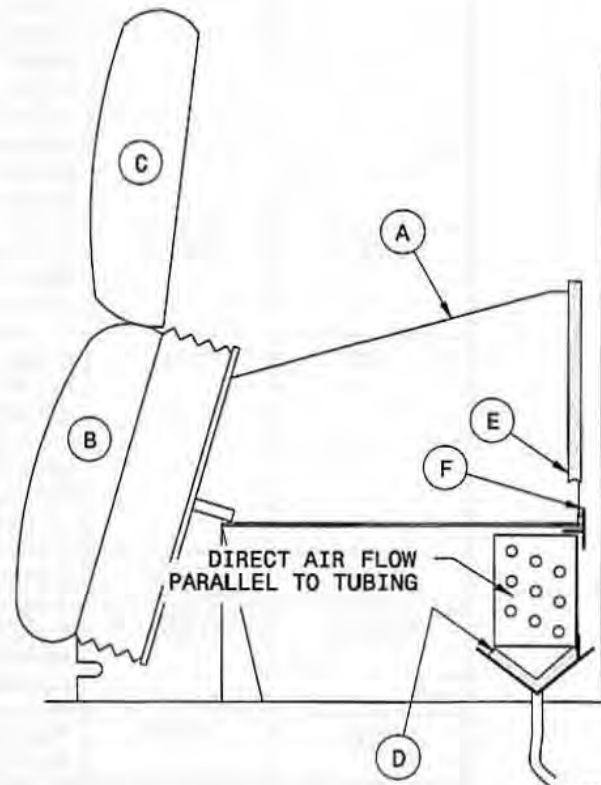

101679

EVAPORATOR CORE ACCESS & CLEANING

MAINTENANCE/SERVICE

Cab Air System

COMPRESSOR PROTECTION

The compressor is protected from excessively low suction and high discharge pressures by two switches:

- Low suction pressure switch is located at the outlet of the evaporator (under seat in cab). It will close when the pressure drops below 4±2 psi and re-open when pressure rises above 20±5 psi.
- High discharge pressure switch is located on the receiver drier (rear of tractor, behind right side panel). It will close if pressure exceeds 325±10 psi and re-open when pressure drops below 250±30 psi.

To prevent damage to the compressor, if the air conditioning system is shut down by either switch, locate the source of the problem and correct it before operating the system.

REFRIGERANT OIL

Whenever the machine is first started after storage for more than one week: Turn blower switch to "OFF" and turn A/C temperature control switch to maximum cooling. Start engine and operate at low idle. Click blower switch from "OFF" to "LOW" for one second, then back to "OFF" for 5 to 10 seconds. Repeat this cycle ten times to distribute the oil throughout the system.

LOW SIDE PRESSURE	HIGH SIDE PRESSURE	POSSIBLE CAUSE
VERY LOW	VERY LOW	Lack of R134a
LOW	LOW	Loss of R134a Restriction between condenser and drier
LOW	LOW OR NORMAL	Restriction between drier and expansion valve Expansion valve plugged Expansion valve stuck closed Inoperative blower motor Plugged filter or evaporator core Moisture in system Defective temperature control switch Restriction at expansion valve Restriction in evaporator Restriction between evaporator and compressor suction
HIGH	LOW	Compressor belt slipping Magnetic clutch slipping Compressor internal failure
HIGH	HIGH	Condenser malfunction Condenser coil plugged Expansion valve stuck open Restriction between compressor and condenser Restriction inside condenser Overcharge of refrigerant Air in system
HIGH	NORMAL	Expansion valve stuck open
NORMAL	HIGH	Restriction between compressor and condenser Restriction inside condenser Overcharge of refrigerant
LOW	HIGH	Restriction between compressor and condenser Restriction inside condenser

NOTE: Service ports are located on suction and discharge hoses at compressor.

MAINTENANCE/SERVICE

Maintenance Schedule

The following maintenance schedule is a listing of periodic maintenance procedures, organized by service intervals. For detailed instruction, see the specific heading in Maintenance/Service section. Use "Fuels, Fluids and Lubricants as specified under that heading.

SERVICE INTERVALS

The recommended service intervals are in hours of operation. Use the hour meter in the cab to indicate when the next service interval has been reached.

IMPORTANT: Recommended intervals are for average conditions. Service windrower more often if operated under adverse conditions (severe dust, extra heavy loads, etc.). Regular maintenance is the best insurance against early wear and untimely breakdowns. Following this schedule will increase machine life.

Where a service interval is given in more than one time frame, eg. "100 Hours or Annually", service the windrower at whichever interval is reached first.



CAUTION: Carefully follow safety messages given under "Service Procedures".

AT FIRST USE:

See "Break-In Period" in Operation section.

10 HOURS OR DAILY

1. Grease driveline.
2. Check tire inflation.
3. Check engine oil level.
4. Check engine coolant level at reserve tank.
5. Clean radiator, hydraulic oil cooler, and A/C condenser.
6. Clean cab fresh air intake filter.
7. Check hydraulic oil level.
8. Check air cleaner restriction gauge. Clean element when indicated.
9. Fill fuel tank.
10. Check fuel sediment bowl, clean if necessary.
11. Drain fuel filter water trap - diesel engine.

50 HOURS

1. Grease caster pivots
2. Grease header drive pulley.
3. Grease header clutch pivot.
4. Grease transmission driveline.
5. Grease walking beam center pivot.
6. Grease top lift link rear pivot.
7. Grease forked caster spindle bearings.
(16.5 tire only)

MAINTENANCE/SERVICE

Maintenance Schedule

100 HOURS OR ANNUALLY *

1. Adjust park brake.
2. Clean cab return air filters.

200 HOURS OR ANNUALLY*

1. Change engine oil and filter.
2. Clean out muffler accumulation.
3. Check bevel gear box oil level.
4. Check power wheel lubricant level.
5. Grease caster wheel hub bearings.

ANNUALLY*

1. Change fuel tank vent line filter.
2. Check battery fluid level.
3. Check battery charge.
4. Check anti-freeze concentration.
5. Cycle blower switch to distribute A/C refrigerant oil.

END OF SEASON: See "Storage Procedure" in Operation section.

300 HOURS OR 2 YEARS

1. Change engine coolant.
2. Change hydraulic oil filters.

500 HOURS

1. Change fuel filters - diesel engine.

1000 HOURS OR 3 YEARS

1. Change engine air cleaner filter element.
2. Change bevel gear box lubricant.
3. Check wheel bolt/nut torque.
4. Check engine valve tappet clearance.
5. Change power wheel oil.

2000 HOURS

1. Change hydraulic oil.
2. General engine inspection.

* It is recommended that Annual Maintenance be done prior to start of operating season.

MAINTENANCE RECORD

Windrower Tractor Serial No. _____

Combine this record with Header Maintenance Record for complete unit service.
See Maintenance/Service section for details on each procedure. Copy these pages to continue record.

ACTION:	✓ - Check	● - Lubricate	▲ - Change	☼ - Clean	+ - Add															
Hour Meter Reading /																				
Serviced Maintenance By:																				
BREAK-IN	See "Break-In Period" in Operation section for checklist.																			
10 HOURS or DAILY																				
● Driveline																				
✓ Tire Pressure																				
✓ Engine Oil Lines																				
✓ Engine Coolant																				
☼ Screens/Coolers																				
☼ Cab Fresh Air Filter																				
✓ Hydraulic Oil																				
✓ Air Cleaner Restr. Gauge																				
+ Refuel																				
✓ Fuel Sediment Bowl Roller																				
✓ Fuel Filter Water Trap																				
50 HOURS																				
● Header Drive Pulley																				
● Header Clutch Pivot																				
● Transmission Driveline																				
● Walking Beam Pivot																				
● Lift Link Rear Pivot																				
● Caster Pivots																				
● Forked Caster Spindle Brq																				
100 HOURS OR ANNUALLY																				
✓ Park Brake																				
☼ Cab Return Air Filters																				
200 HOURS OR ANNUALLY																				
▲ Engine Oil & Filter																				
☼ Muffler Accumulation																				
✓ Bevel Gear Box Oil Level																				
✓ Power Wheels Lube Level																				
● Caster Wheel Hub Bearings																				
ANNUALLY																				
▲ Fuel Tank Vent Filter																				
✓ Battery Fluid																				
✓ Battery Charge																				
✓ Anti-Freeze																				
✓ A/C Refrigerant Oil																				
Storage Procedure	See "Storage Procedure" in Operation section for checklist																			
CONTINUED NEXT PAGE																				

MAINTENANCE RECORD (continued)

ACTION:	✓ - Check	● - Lubricate	▲ - Change	✱ - Clean	+ - Add
<div style="display: flex; justify-content: space-between;"> <div style="width: 45%;">Hour Meter Reading /</div> <div style="width: 55%;">Serviced By:</div> </div>					
Maintenance Procedure					
300 HOURS OR 2 YEARS					
▲ Engine Coolant					
▲ Hydraulic Oil Filters					
500 HOURS					
▲ Fuel Filters					
1000 HOURS OR 3 YEARS					
▲ Power Wheel Oil					
▲ Bevel Gear Box Oil					
▲ Air Cleaner Element					
✓ Wheel Bolt Torque					
✓ Valve Tappets					
2000 HOURS					
✓ General Engine Inspection					
▲ Hydraulic Oil					

TROUBLE SHOOTING

<u>SYMPTOM</u>	<u>PROBLEM</u>	<u>SOLUTION</u>	<u>REF.</u>
Air conditioning not producing sufficient cooling (continued).	Clogged expansion valve.	Recover system refrigerant and replace valve. Then, evacuate and charge system.	*
	Clogged receiver-drier.	Recover system refrigerant and replace receiver-drier. Then evacuate and charge system.	*
	Excessive moisture in system.	Recover system refrigerant and replace receiver-drier. Then evacuate and charge system.	*
	Air in system.	Recover refrigerant, evacuate and charge system.	*
	Thermostat defective or improperly adjusted.	Replace thermostat.	*
Air conditioning system too noisy.	Blower motor sluggish in operation.	Remove motor for service/replacement.	*
	Defective winding or improper connection in compressor clutch coil or relay.	Repair or replace as necessary.	*
	Loose or excessively worn drive belt.	Tighten or replace as required.	59
	Noisy clutch.	Remove clutch for service or replacement as required.	*
	Noisy compressor.	Check mountings and repair. Remove compressor for service or replacement.	*
	Compressor oil level low.	Add SP-20 PAG refrigerant oil.	*
	Blower fan noisy due to excessive wear.	Remove blower motor for service or replacement as necessary.	*
	Excessive charge in system.	Discharge excess refrigerant until pressure drops within specs. (Always recover discharged refrigerant.)	*
	Low charge in system.	Check system for leaks, charge system.	*

* See your Windrower dealer.

TROUBLE SHOOTING

<u>SYMPTOM</u>	<u>PROBLEM</u>	<u>SOLUTION</u>	<u>REF.</u>
Air conditioning system too noisy. (continued)	Excessive moisture in system.	Replace receiver-drier, evacuate & charge system.	*
Air conditioning cools intermittently.	Compressor clutch slipping.	Slippage over a prolonged period will require removing clutch for service. May require adjustment for proper spacing.	*
	Unit icing up due to: <ul style="list-style-type: none"> • thermostat adjusted too low. • excessive moisture in system. • incorrect super-heat adjustment in expansion valve. 	<ul style="list-style-type: none"> • Adjust thermostat. • Replace receiver-drier. • Replace expansion valve. 	*
	Thermostat defective.	Replace thermostat.	*
	Defective blower switch or blower motor.	Remove defective part for service/replacement.	*
	Partially open, improper ground, or loose connection in compressor clutch coil.	Check connections or remove clutch coil for service or replacement.	*
Windows fog up.	High humidity.	Run A/C to dehumidify air <u>and</u> heater to control temperature.	19

Engine

Engine hard to start or will not start.	Controls not in neutral.	<ul style="list-style-type: none"> • Move variable speed lever to neutral. • Move steering wheel to locked position. • Disengage header clutch. 	28
	Header drive idler not pivoted against stop to close neutral switch.	Remove key from ignition. From under tractor, push up on idler to complete pivot travel, closing neutral switch.	96
	Neutral lock misadjusted.	Check neutral lock.	96
	No fuel to engine.	Fill empty fuel tank, replace clogged filters.	64
	Old fuel in tank.	Drain tank, refill with fresh fuel.	64

* * See your Windrower dealer.

TROUBLE SHOOTING

<u>SYMPTOM</u>	<u>PROBLEM</u>	<u>SOLUTION</u>	<u>REF.</u>
Engine hard to start or will not start. (cont'd)	Water, dirt or air in fuel system.	Drain, flush, fill and bleed system.	67
	Improper type of fuel.	Use proper fuel for operating conditions.	53
	Diesel: Hand lever on lift pump raised.	Push lever down.	67
	Crankcase oil too heavy.	Use recommended oil.	54
	Low battery output.	Have battery tested. Check battery electrolyte level.	74
	Poor battery connection.	Clean and tighten loose connections.	74
	Faulty starter.	Repair or replace.	*
	Wiring shorted, circuit breaker open.	Check continuity of wiring and breaker (manual reset).	79
Engine knocks.	Diesel engine - faulty injectors.	Clean or replace injectors.	*
	Insufficient oil.	Add oil.	58
	Engine out of time.	Diesel - Time injection pump.	*
	Low or high coolant temperature.	Remove and check thermostat. See "Engine Overheats".	*
Low oil pressure.	Improper fuel.	Use proper fuel.	53
	Low oil level.	Add oil.	58
	Improper type of oil.	Drain, fill crankcase with proper oil.	54
High oil consumption.	Worn components.	Repair engine.	*
	Crankcase oil too light.	Use recommended oil.	54
	Oil leaks.	Check for leaks around gaskets, seals, and drain plugs.	—
	Internal parts worn.	Check for worn parts.	*

* See your Windrower dealer.

TROUBLE SHOOTING

<u>SYMPTOM</u>	<u>PROBLEM</u>	<u>SOLUTION</u>	<u>REF.</u>
Engine runs irregularly or stalls frequently.	Unsteady fuel supply.	Change filter on fuel tank vent line. Replace clogged fuel filters.	64
	Water, dirt or air in fuel system.	Drain, flush, fill and bleed system.	67
	Low coolant temperature.	Remove and check thermostat.	*
	Diesel - Dirty or faulty injectors.	Clean or replace injectors.	*
Lack of power.	Incorrect timing.	Diesel - Time injection pump.	*
	Engine oil viscosity too high.	Use recommended oil.	54
	Intake air restriction.	Service air cleaner.	62
	Clogged fuel filter.	Replace fuel filter.	66
	High back pressure.	Clean out muffler.	69
	Improper type of fuel.	Use proper fuel.	53
	High or low engine temperature.	Remove and check thermostat. See "Engine Overheats".	*
	Improper valve clearance.	Set valve clearance.	*
	Diesel engine - faulty injectors.	Clean or replace injectors.	*
	Engine temperature below normal.	Defective thermostat.	Remove and check thermostat.

* See your Windrower dealer.

TROUBLE SHOOTING

<u>SYMPTOM</u>	<u>PROBLEM</u>	<u>SOLUTION</u>	<u>REF.</u>
Warning buzzer sounds.	Engine overheated.	Check coolant level and thermostat.	70
	Park brake engaged.	Release brake.	20
	Low engine oil pressure.	Check oil level.	58
	Low transmission oil pressure.	Check oil level.	84
Engine overheats.	Low coolant level.	Fill reserve tank to proper level. Check system for leaks.	70
	Engine overloaded.	Reduce ground speed.	31
	Defective radiator cap.	Replace cap.	70
	Loose or defective fan belt.	Adjust or replace belt.	60
	Dirty radiator screen:		
	• Rotors turning	• Check for obstructions in ducting from screen to fan shroud.	—
	• Rotors not turning	• Check connections to rotor electric motor. • Check in-line fuse.	— 72
	Dirty radiator core.	Clean radiator.	72
	Cooling system dirty.	Flush cooling system.	71
	Defective thermostat.	Remove and check thermostat.	*
	Defective temperature gauge or sender.	Check coolant temperature with thermometer, replace if necessary.	*
High fuel consumption.	Defective water pump.	Repair or replace.	*
	Water only for coolant.	Use antifreeze.	70
	Improper type of fuel.	Use proper fuel.	53
	Clogged or dirty air cleaner.	Service air cleaner.	62
	Engine overloaded.	Reduce ground speed.	31
	Improper valve clearance.	Reset valves.	*

* See your Windrower dealer

TROUBLE SHOOTING

<u>SYMPTOM</u>	<u>PROBLEM</u>	<u>SOLUTION</u>	<u>REF.</u>
High fuel consumption (continued).	Engine out of time.	Diesel - Time injection pump.	*
	Low engine temperature.	Check thermostat.	*
	Diesel engine - injection nozzles dirty.	Clean or replace injectors.	*
Diesel engine emits black or grey exhaust.	Improper type of fuel.	Consult your fuel supplier and use proper type fuel for conditions.	53
	Engine overloaded.	Reduce ground speed.	31
	Clogged or dirty air cleaner.	Service air cleaner.	62
	Defective muffler.	Check muffler for possible damage which might create back pressure.	69
	Dirty or faulty injectors.	Clean or replace injectors.	*
	Engine out of time.	Time injection pump.	*
	Air in fuel system.	Bleed fuel system.	67
Diesel engine emits white exhaust.	Improper type of fuel.	Consult your fuel supplier and use proper type fuel for conditions.	53
	Cool engine.	Warm engine up to normal operating temperature.	29
	Defective thermostat.	Remove and check thermostat.	*
	Engine out of time.	Time injection pump.	*
Starter cranks slowly or will not operate.	Low battery output.	Check battery charge.	74
	Controls not in neutral.	<ul style="list-style-type: none"> • Move variable speed lever to neutral. • Move steering wheel to center position. • Disengage header clutch. 	28
	Cylinder for engaging header drive belt not retracted.	Determine cause of cylinder malfunction and repair.	*

* See your Windrower dealer.

TROUBLE SHOOTING

<u>SYMPTOM</u>	<u>PROBLEM</u>	<u>SOLUTION</u>	<u>REF.</u>
Starter cranks slowly or will not operate (cont'd)	Relay not functioning.	Check relay and wire connections.	*
	Loose or corroded battery connections.	Clean and tighten loose connections.	74
	Key switch worn or terminals loose.	Check switch and terminals.	*
	Crankcase oil too high viscosity.	Use recommended oil.	54
	Main circuit breaker tripped.	Reset main circuit breaker.	79
	Main circuit breaker defective.	Replace circuit breaker.	*
Air filters require frequent cleaning.	Vacuator plugged.	Clean out vacuator.	62

Electrical

Low voltage and/or battery will not charge.	Defective battery.	Have battery tested.	*
	Loose or defective alternator belt.	Adjust belt. Replace worn belt.	59
	Loose or corroded connections.	Clean and tighten battery connections.	74
	Dirty or defective alternator, defective voltage regulator, or high resistance in circuit.	Check circuit.	*
	Alternator or voltage regulator not connected properly.	Connect properly.	76
Lights dim.	High resistance in circuit or poor ground on lights.	Check the wiring circuit for a break in a wire or a poor ground.	*
	Defective light switch.	Replace switch.	*

* See your Windrower dealer.

TROUBLE SHOOTING

<u>SYMPTOM</u>	<u>PROBLEM</u>	<u>SOLUTION</u>	<u>REF.</u>
Lights do not light.	Defective light switch.	Replace switch.	*
	Broken wiring; open or defective circuit breaker.	Check wiring for broken wire or shorts, check circuit breaker.	79
	Defective relay.	Replace relay.	*
	Poor ground on lights.	Clean and tighten ground wires.	—
Turn signals or indicators showing wrong direction.	Reversed wires.	Connect properly.	*
No current to cab.	Main circuit breaker tripped.	Reset main breaker.	79
	Broken or disconnected wire.	Check wiring for a broken, loose or shorted wire.	*

Traction Drive System

Warning buzzer sounds and transmission oil light is on.	Low hydraulic oil level.	Stop engine, add oil.	84
	Low hydraulic pressure.	Check and replace check valve if defective.	94
	Foreign material shorting sender.	Clean top of sender.	—
	Short in buzzer wiring.	Check wiring to buzzer.	*
	Faulty sender.	Replace sender.	*
Wheels lack pulling ability on a grade or pulling out of a ditch.	Insufficient torque at drive wheels.	Move speed-range control to field position and reduce ground speed.	31
	Loose or worn controls.	Check controls.	*
	Air in system.	Use proper oil, check oil level, check oil filter and leaks.	84
	Brakes dragging.	Check brake linkages for full release.	107
	Internal pump or motor damage.	Check pump and/or motor.	*
	Relief valve in tandem pump dirty or damaged.	Replace relief valve.	*

* See your Windrower dealer.

TROUBLE SHOOTING

<u>SYMPTOM</u>	<u>PROBLEM</u>	<u>SOLUTION</u>	<u>REF.</u>
Both wheels will not pull in forward or reverse.	Low oil level.	Check oil reservoir level.	84
	Power wheels disengaged.	Engage power wheels.	105
	Damaged hydraulic lines preventing proper oil flow.	Replace damaged lines.	*
	Steering controls worn or defective.	Check variable speed lever and steering for loose, worn or damaged ball joints and connecting rods.	*
	Speed-range control not working.	Adjust speed-range control linkage.	103
	Pump arms have broken shaft or loose hardware.	Repair or tighten.	*
	Brakes binding or not releasing fully.	Adjust brakes and remove any foreign objects .	107
	Charge pressure relief valve misadjusted or damaged.	Check the valve adjustment. Check valve parts and seat.	*
One wheel does not pull in forward or reverse.	Failed pump or motor.	Repair or replace pump or motor.	*
	One power wheel disengaged.	Engage power wheel.	105
	Pump arm has broken shaft or sheared roll pin.	Replace shaft or roll pin.	*
	Steering controls worn or defective.	Check variable speed lever and steering for loose, worn or damaged ball joints and connecting rods.	*
	Damaged hydraulic lines preventing proper oil flow.	Replace damaged lines.	*
	Brakes binding or not releasing fully.	Adjust brakes and remove any foreign objects.	107

* See your Windrower dealer.

TROUBLE SHOOTING

<u>SYMPTOM</u>	<u>PROBLEM</u>	<u>SOLUTION</u>	<u>REF.</u>
One wheel does not pull in forward or reverse (continued).	Speed-range control not working.	Adjust speed-range control linkage.	103
	High pressure relief valve stuck open, damaged seat.	Check valve and clean or replace.	*
	Failed pump, motor or power wheel.	Repair or replace failed component.	*
With steering wheel centered, one wheel pulls more than the other.	Leakage at pump or motor.	Repair pump or motor.	*
	Faulty relief valve.	Repair or replace valve.	*
Excessive noise from drive system.	Hydraulic line clamps loose.	Tighten clamps.	—
	Brakes dragging.	Adjust brakes for full release.	107
	Faulty pump or motor.	Repair or replace pump or motor.	*
	Air in system.	Check lines for leakage.	*
Hydraulic oil filter leaks at seal.	Not properly tightened.	Tighten filter element.	—
	Damaged seal or threads.	Replace filter or filter head.	85

Steering and Ground Speed Controls

Machine will not steer straight.	Linkage worn or loose.	Replace worn parts, adjust linkage.	*
Machine moves on flat ground with controls in neutral.	Neutral lock misadjusted. See note below.	Adjust neutral lock.	96
	Parking brake out of adjustment.	Adjust brakes.	107
Insufficient road speed.	Speed-range control in Field Position.	Move to Road Position.	20
2-speed lever moves out of position.	2-speed linkage misadjusted. See note below.	Adjust 2-speed linkage.	103

NOTE: A more complete Troubleshooting guide is given for the Neutral Lock & Steering on page 99, and for the 2-Speed Linkage on page 103.

* See your Windrower dealer.

TROUBLE SHOOTING

<u>SYMPTOM</u>	<u>PROBLEM</u>	<u>SOLUTION</u>	<u>REF.</u>
Header Hydraulics			
Header or reel not lifting.	Contaminant in relief valve.	Clean relief valve at cylinder control valve.	86
	Appropriate solenoids not being energized by activating switch.	Check electrical connections; repair or replace solenoid(s).	*
Header or reel lifts but lacks power.	Relief pressure too low, or contaminant in relief valve.	Check/adjust/clean relief valve at cylinder control valve.	86
Reel and/or conveyor not turning.	Header drive switch not engaged.	Engage switch.	21
	Flow controls turned down too low.	Turn flow control clockwise to increase flow.	21
	Contaminant in relief valve.	Clean relief valve at flow control block.	88
	Appropriate solenoid on flow control block not being energized.	Check electrical connections; repair or replace solenoid.	*
Reel and/or conveyor turns but lacks power.	Relief pressure too low, or contaminant in relief valve.	Check/adjust/clean relief valve at flow control block.	88
Reel and/or conveyor fluctuates under load (940 & 960 Headers)	Flow controller knobs positioned incorrectly.	Position reel and conveyor control knobs so that sum of knob position readings does not exceed 16.	21

Header Drive

Sickle drive not engaging.	Header drive switch in cab not engaged.	Engage switch.	21
	Tensioning cylinder front pivot bolt too tight, preventing idler bracket from rotating up to switch.	Adjust locknuts to allow free movement of cylinder ram on bolt.	—
	Rear lower belt support pivot too tight, preventing cylinder from contacting switch at front.	Adjust locknuts to allow free movement of support on pivot bolt.	92

* See your Windrower dealer

TROUBLE SHOOTING

<u>SYMPTOM</u>	<u>PROBLEM</u>	<u>SOLUTION</u>	<u>REF</u>
Header Drive			
Sickle drive not engaging (continued)	Appropriate solenoid not being energized by activating switch.	Check electrical connections; repair or replace solenoid.	*
	Header drive belt tension too low.	Check hydraulic pressure at tensioning cylinder. Should be between 150 & 250 psi.	—
		Check for plugged orifice at cylinder.	—
Sickle drive engages but lacks power.	Header drive belt tension too low.	If pressure is below 150: 1) Check charge pres're 2) Repair/replace pump	94 *
		See "Sickle drive not engaging" (previous page).	—
Belt will not disengage.	Worn belt.	Replace belt.	90
	Tensioning cylinder front pivot bolt too tight, preventing idler bracket from rotating away from switch.	Adjust locknuts to allow free movement of cylinder ram on bolt.	—
Belt vibration.	Rear lower belt support pivot too tight, preventing cylinder from disengaging switch at front.	Adjust locknuts to allow free movement of support on pivot bolt.	92
	Belt has shrunk due to over-heating when disengaged, or excessive slipping when engaged.	Replace belt. Adjust belt guides and keepers. Check hydraulic pressure at tensioning cylinder (see above).	92
	Burnt spot or band cut in one place.	Replace belt.	90
Band split full length of belt.	Misalignment of pulleys.	Replace belt and adjust pulleys.	90
Sections of band missing from belt.	Misalignment of pulleys.	Replace belt and align pulleys.	90
	Idlers not square with pulleys.	Align idlers.	91

* See your Windrower dealer.

TROUBLE SHOOTING

<u>SYMPTOM</u>	<u>PROBLEM</u>	<u>SOLUTION</u>	<u>REF</u>
Header Drive (continued)			
Belt band frayed and separated from V-belt at one side.	Belt has jumped one groove at front pulley: Belt shield too far from pulley.	Adjust pulley shield.	93
	Belt guides and shields not properly adjusted.	Adjust belt guides and keepers	92
Belt bands or sides of belt prematurely worn. Burnt paint on shields or guides.	Belt guides and keepers too close to belt.	Adjust belt guides and keepers.	92
<hr/>			
Park Brake			
Loss of brake capacity.	Brake force adjusted too low.	Increase brake force.	107
	Brake bands soaked with oil.	Eliminate oil leak and replace brake bands.	*
	Brake bands worn.	Replace brake bands.	*
Incomplete brake release.	Brake force adjusted too high.	Decrease brake force.	107
	Foreign material caught around brake band area.	Remove material.	—
<hr/>			
Operator's Seat			
Rough ride.	Seat suspension not adjusted for operator's weight.	Adjust seat suspension.	23
	High air pressure in tires.	Deflate to proper pressure.	11

* See your Windrower dealer.

OPTIONS AND ATTACHMENTS

Consult your Windrower dealer for details on the following Options & Attachments.

NOTE: If not factory ordered, installation of these kits is to be done by Windrower dealer.

Engine Tachometer

WholeGoods order number: B2303

Mounted at the bottom of the machine monitor panel to the right of the operator, the tachometer indicates engine speed in revolutions per minute (RPM).

Air Intake Screen Cleaner

WholeGoods order number: B2288

This automatic screen cleaning device "vacuums" the screen by means of two rotors.

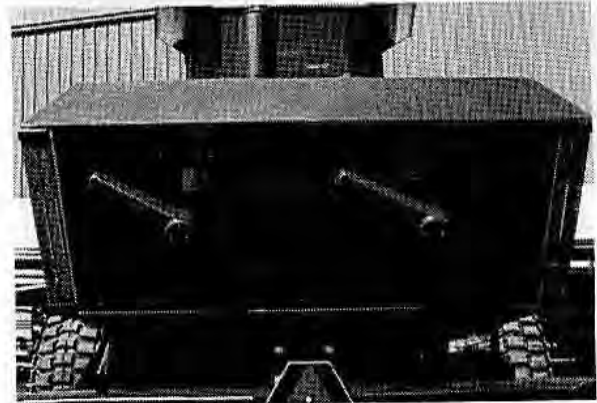

AIR INTAKE SCREEN CLEANER

Rear Weight Package

WholeGoods order number: B2266

For heavier headers (3000 lbs. plus, including reel) in hilly conditions, weight may be added to rear of tractor frame. One or two weight packs may be installed, as described on page 39.

Auxiliary Float Spring

WholeGoods order number: B2773

For heavier headers (e.g. 36' 972 and 16' 920), this kit consists of an inner spring which installs inside one of the main float springs on heavier side.

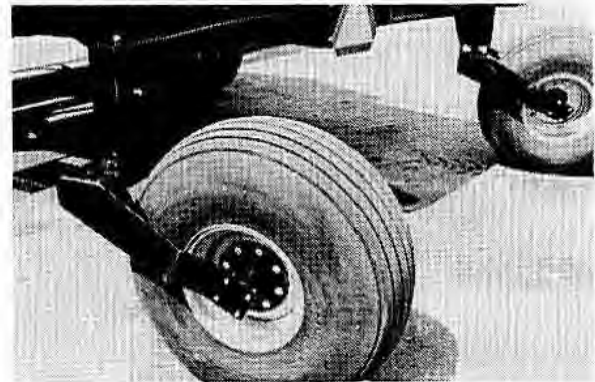

FORKED CASTER OPTION

Forked Tail-Wheel Casters

WholeGoods order number: B1854 – 9.5 tires
B2689 – 16.5 tires

Optional to formed casters, the forked tail-wheel casters are available for 9.5L - 14 tires or for 16.5L - 16.1 tires.

Header Drop Module

WholeGoods order number: B2600

Allows the header lift cylinders to completely retract and lower the header with only momentary activation of the header height control switch. Installation instructions are included with the kit.

The following attachments may be obtained from these approved sources:

Speedometer / Acre Counter

Micro-Trak Systems, Inc.

Mankato, Minnesota

Ph. 1-800-328-9613

OR

Agtron Enterprises

Saskatoon, Saskatchewan

Ph. 1-800-667-0640

Radio

REI (Radio Engineering Industries, Inc.)

Omaha, Nebraska

Ph. 1-800-228-9275

UNLOADING



WARNING: To avoid personal injury or death do not attempt to drive the windrower off the carrier. It must be lifted or towed. When starting the windrower, slight movement of the steering wheel could cause fast and hard-to-correct movement on a small surface such as a trailer bed. This could cause the machine to fall from the carrier onto the ground.

Prepare to Unload



CAUTION: To avoid injury to bystanders from being struck by machinery, do not allow persons to stand in the unloading area.

1. Move trailer into position and block trailer wheels.
2. Lower trailer storage stands.



CAUTION: Unloading equipment must meet or exceed the specified requirements. Using inadequate equipment may result in vehicle tipping or machine damage.



PREPARE TO UNLOAD

Two Forklift Method

FORKLIFT REQUIREMENTS: Two forklifts, each with a 5000 lb. (2270 kg) capacity and minimum 8 ft. (2.5 m) lift height.

1. Set forklift tines to the widest possible setting.
2. Position one forklift on either side of trailer bed.

NOTE: Windrower center of gravity is approximately 48 inches (1220 mm) rearward of drive wheel center.

3. Place forks under windrower frame on both sides.
4. Lift with both forklifts simultaneously until windrower is clear of trailer bed.
5. Drive truck slowly forward until trailer bed is clear of windrower.
6. Lower unit slowly and simultaneously with both forklifts to approximately 24 inches (600 mm) from ground.
7. Install front and rear tires. See "Tires" in Assembly section.
8. Lower unit to ground.

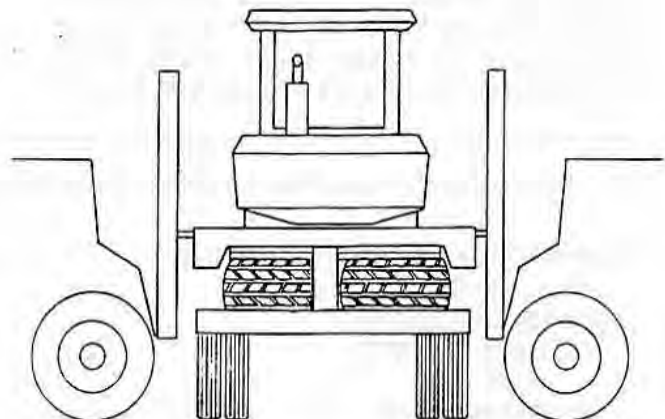

UNLOADING WITH TWO FORKLIFTS

UNLOADING

One Forklift Method

FORKLIFT REQUIREMENT: One forklift with a 5,000 lb. (2270 kg) capacity.

CHAIN REQUIREMENTS: Overhead lifting quality chain with a minimum 5000 lb. (2270 kg) working load limit.

1. Back rear of truck bed up to an unloading dock which is the same height or slightly lower than the trailer bed. Remove miscellaneous parts shipped under tractor frame.
2. Set forklift tines to the widest possible setting.
3. Drive the forklift up to the windrower from the rear and place forks under the rear frame cross member.
4. Lift rear end of windrower and remove drive wheels from under frame.
5. Install chains from forklift mast to triangular brackets (A) at rear of both windrower frame front legs. Be sure both chains are the same length.



CAUTION: The front frame legs rest on the trailer bed on skid shoes (S). Be sure there are no obstructions to prevent rearward sliding of the skid shoes and watch carefully that as unit is dragged, the skid shoes are not sliding sideways towards the side edge of the trailer bed.

6. Drag windrower rearward off of carrier.
7. Remove chains and install front and rear tires. See "Tires" in Assembly section.

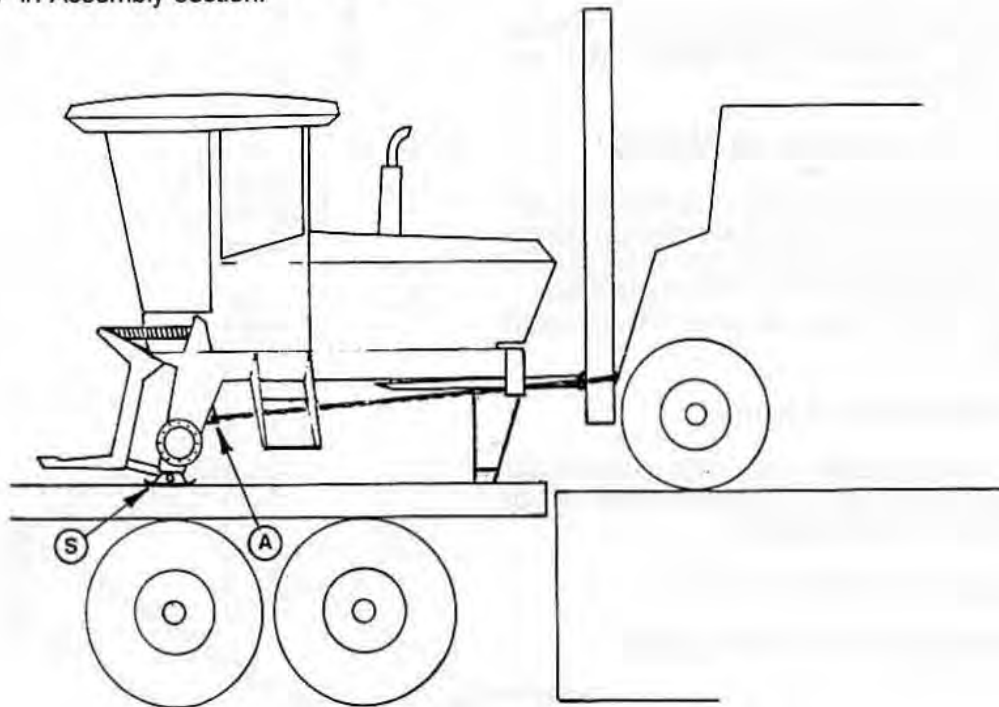

UNLOADING WITH ONE FORKLIFT

ASSEMBLY

NOTE: The purpose of shipping preparations such as having no battery is to better adapt the unit for an extended non-active period. If the machine is to remain non-active for a long period of time, do not perform the following assembly work until necessary. Also, further prepare the unit for storage as instructed in this manual.

Tires

16.5 REAR TIRES Install as follows:

1. Lift rear end of windrower with forklift and remove yellow shipping support from walking beam. Replace bolts securing walking beam pivot tube bracket and torque to 390 N-m (290 ft.lbs.).
2. Liberally apply multi-purpose grease to one surface of plate (G). Install plate (G) over caster pivot shaft with greased surface down.
3. Note that outer holes on plate (G) are not equally spaced from center hole. This is to align with bolt heads (H) under walking beam. Rotate plate (G) to align holes in plate with bolt heads.
4. Install caster (E) into walking beam by raising the caster and lowering walking beam onto pivot shaft. Ensure holes in plate (G) engage bolt heads (H).
5. Install spacer (J) into hole on top of beam.
6. In the following order, install parts onto spacer (J): **NOTE:** Install bearing (F) with smaller I.D. race facing down. Bearing (F), 3/4 SAE flatwasher (K), spring (L), 1/2 inch large O.D. flatwasher (M) and lockwasher (N).
7. Install bolt (P) to fasten the assembly.
8. Measure length of spring (L) and add or remove 3/4 SAE flatwashers (K) under spring to provide a spring length of 89 to 92 mm (3-1/2 to 3-5/8 inch). Torque bolt (P) to 115 N-m (85 ft.lbs.) **NOTE:** Do not place washers (K) on top of spring.
9. Slide cap (R) over assembly.
10. Grease the caster pivot with multi-purpose grease, continuing until grease is forced out top or bottom of walking beam.
11. Set caster tire pressure at 10 psi.
12. Repeat steps 2 to 11 at other caster.
13. Place rear casters in the outboard position (extending behind walking beam) and lower windrower to ground.

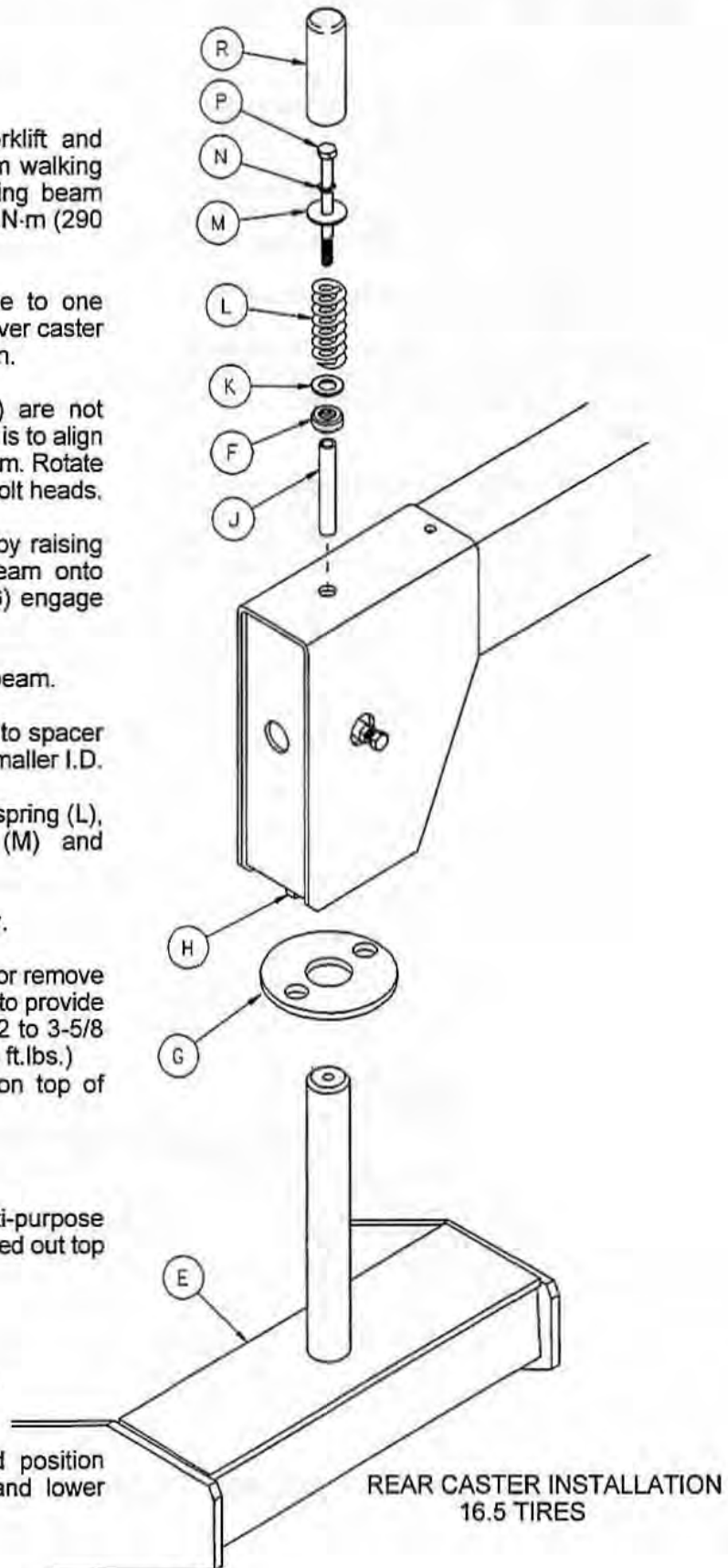

ASSEMBLY

Tires

9.5 REAR TIRES

Install as follows:

1. Lift rear end of windrower with forklift and remove yellow shipping support from walking beam. Replace bolts securing walking beam pivot tube bracket and torque to 390 N·m (290 ft.lbs.).
2. Install casters in rear beam as shown.
NOTE: When installing rear casters, ensure that smaller I.D. race of thrust bearing (A) is towards caster.
3. Place rear casters in the outboard position (extending behind rear beam) and lower rear of windrower to ground.

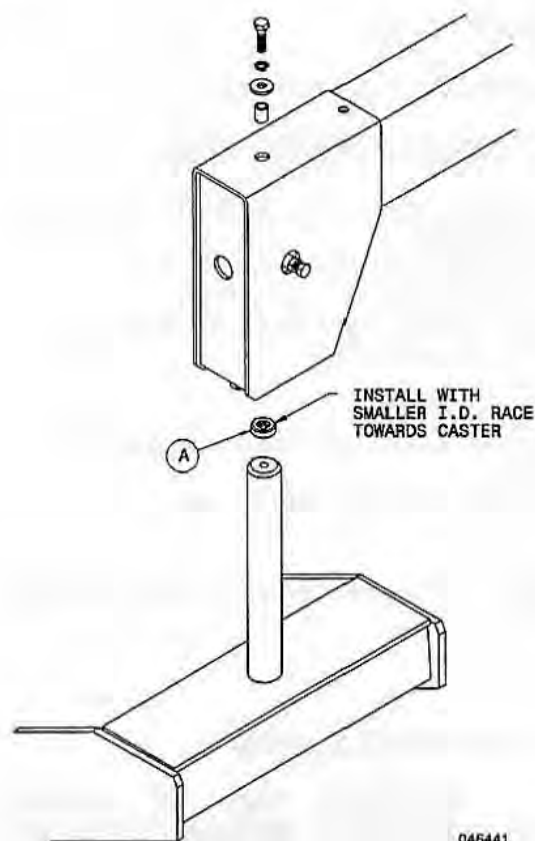

REAR CASTER INSTALLATION: 9.5 TIRES

DRIVE TIRES

IMPORTANT: For units shipped via container, it is necessary to remove the power wheel assemblies. For dual-speed units, after installing wheel/motor assemblies, perform dual-speed linkage adjustments #3 and #4 as described on page 104.

Install tires on a hard, level surface as follows:

1. Lift front end of windrower using a forklift and place 14" (35 cm) blocks under yellow skid shoes (S) on front frame legs.
2. Install drive tires onto power wheels ensuring tire tread points forward and air valve stems are on the outside.
NOTE: For "Turf and Field" tires (diamond or rectangular tread), be sure arrow on sidewall points in forward rotation.
3. Follow proper bolt tightening sequence and torque specifications. See Maintenance/Service section. Re-check torque after 5 hours operation.
4. Lift front end of windrower with forklift and remove the blocks from under skid shoes. Lower the windrower onto its tires.
5. **IMPORTANT:** Remove yellow skid shoes (S) from front frame legs.

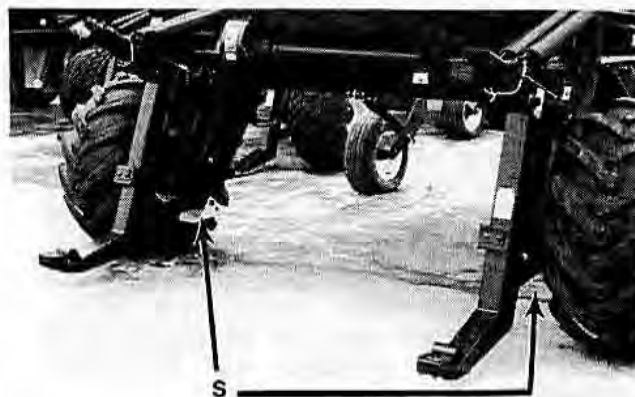

INSTALL DRIVE TIRES & REMOVE SKID SHOES

TIRE INFLATION

Check the tire pressures and adjust if necessary. See decal on cab door for recommended pressures.



CAUTION: When inflating tires, use a clip-on chuck and extension hose long enough to allow you to stand to one side and not facing tire.



STAND TO ONE SIDE WHEN INFLATING TIRES

ASSEMBLY

Battery

The windrower is shipped without battery.

BATTERY RECOMMENDATIONS

A battery with the following specs is recommended:

- 640 amps cold cranking at 0°F (-18°C)
- Reserve Capacity: 180 minutes
- Size: approximately 13 x 6.8 x 9.4 inches (331 x 173 x 238 mm).

Also acceptable:

- Minimum 560 amps cold cranking at 0°F (-18°C)
- Reserve Capacity: 140 minutes

Battery must be vibration proof hybrid type with top posts.

FILL BATTERY (if required)



WARNING: Keep all smoking materials, sparks and flames away from electrolyte container and battery, as gas given off by electrolyte is explosive.

Battery electrolyte causes severe burns. Avoid contact with skin, eyes or clothing. Wear protective eye-wear and heavy gloves.

If electrolyte is spilled or splashed on clothing or on the body, neutralize it immediately with a solution of baking soda and water, then rinse with clean water. Electrolyte splashed into the eyes is extremely dangerous. Should this occur, force the eye open and flood with cool, clean water for five minutes. Call a doctor immediately.

If battery is dry, fill battery cells with electrolyte (battery acid).

CHARGE BATTERY



CAUTION: Follow directions regarding charging battery given in Maintenance/Service section and instructions furnished by the battery charger manufacturer.

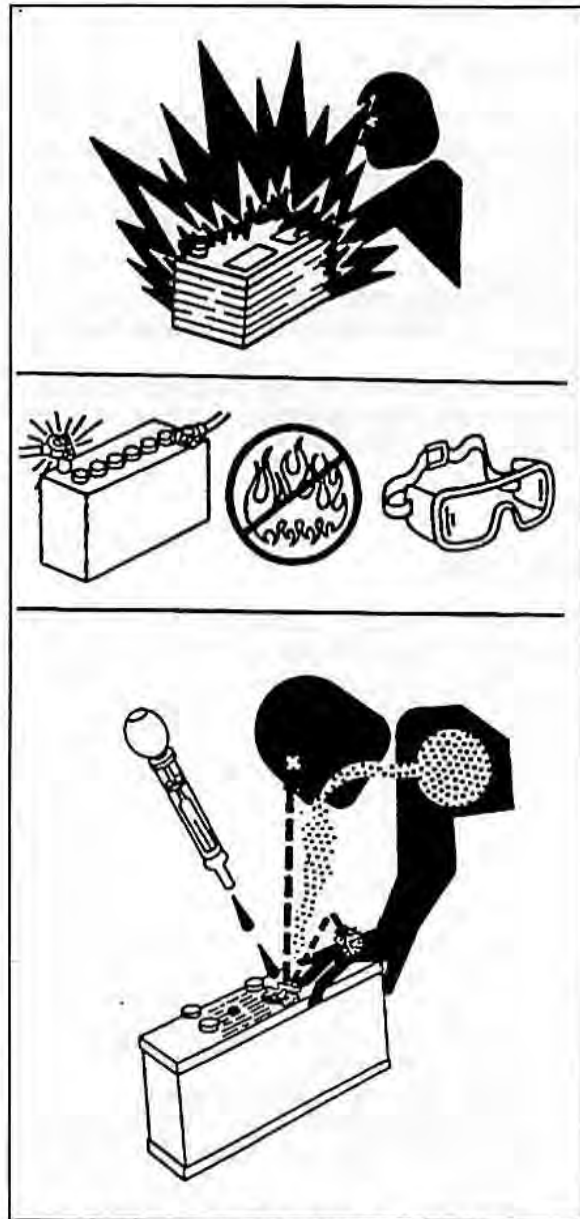

BE CAREFUL AROUND BATTERIES

ASSEMBLY

Battery

INSTALL BATTERY

NOTE: For easier installation, position a low platform on which to stand when placing battery.

1. Lower battery from above onto battery tray located at left rear corner of frame.
2. Install battery holder (A).

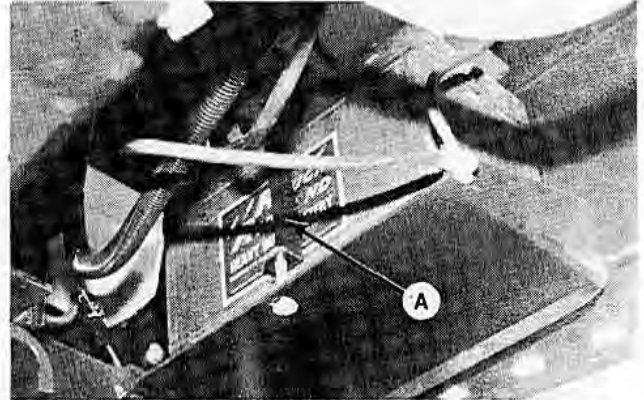

CONNECT BATTERY CABLES

1. Connect starter cable (B) to positive (+) terminal on battery.
2. Connect ground cable (C) to negative (-) terminal on battery.
3. Be sure connections are clean and tight.



INSTALL BATTERY



WARNING: Do not run the engine with battery cables disconnected. High voltage can build up in the frame, creating a shock hazard. Alternator damage will also result.

When the preceding assembly work is complete, the windrower tractor is in running condition.



WARNING: Avoid driving the tractor with header removed. Removing header decreases the weight on drive wheels, reducing steering control. If necessary to drive tractor with header removed, use transmission low speed range, do not exceed HALF maximum engine speed and avoid loose gravel and slopes. Refer to instructions in this manual on Starting, Driving and Stopping the Windrower.

Adjustments and Checks

Perform the final checks and adjustments as listed on the "Pre-Delivery Checklist" (yellow insert) to ensure the machine is field-ready. Use the Operator's Manual for directions.

NOTE: See following pages for Assembly Instructions related to specific headers and attachments. Once these details are completed, attach header to tractor. See Operation section.

Cab Heater

There is a shut-off valve on the heater circuit at the engine. This valve is shipped in the closed position to ensure there is no leakage through the heater circuit when it is not being used. This provides maximum cooling when the air conditioning system is used. If heater is to be used, open valve at (A).

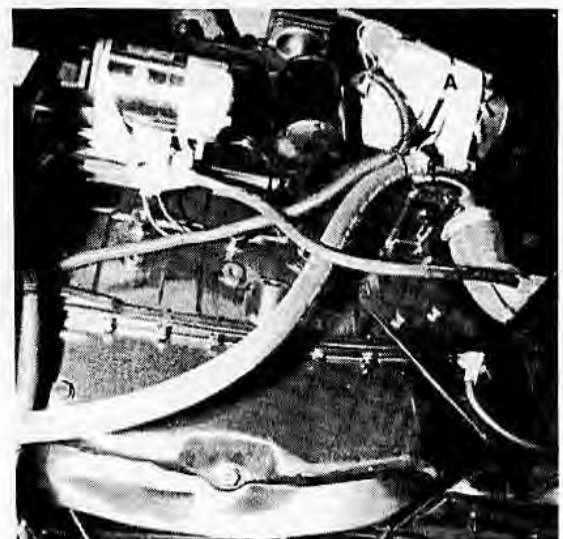

OPEN HEATER VALVE IF REQUIRED

ASSEMBLY

Preparing the Tractor for 960, 962 & 972 Headers

1. Remove plastic blocks (A) on tractor lift legs and reinstall as shown with 1/2 x 5 inch carriage bolts provided.



REPOSITION LIFT LINKAGE BLOCKS

2. For Triple Delivery (Hydraulic Deck Shift) Harvest Header, install deck shift switch (B) (shipped with header) in side console as follows:

- Cut decal to expose switch hole punch-out.
- Remove punch-out and attach wires from harness to switch as shown. Push switch into hole.
- When header is attached, check function of deck shift switch. Pressing left side of rocker switch should shift decks to the left. If pressing left side of rocker shifts decks to the right and vice-versa, exchange positions of the two green wires at the switch.

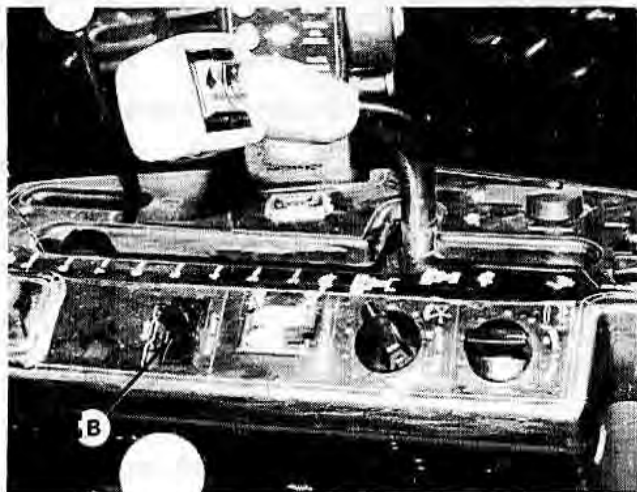

INSTALL DECK SHIFT SWITCH
(Triple Delivery Headers)

3. To prevent improper mixing of oils, if header is to be switched back and forth from combine to windrower, change oil in windrower hydraulic system and in combine adapter hydraulic reservoir to match combine hydraulic system. See "Hydraulic Oil" in Maintenance/ Service section for oil change procedure.

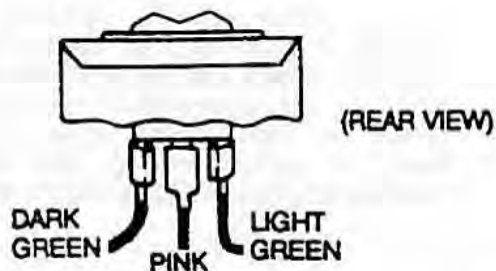

DECK SHIFT SWITCH WIRING

4. For 960/962 Double Delivery Harvest Header, remove draper drive pressure hose (C) from tractor left side and replace with longer hose from adapter kit. (Salvage the male coupler and install on new hose.)

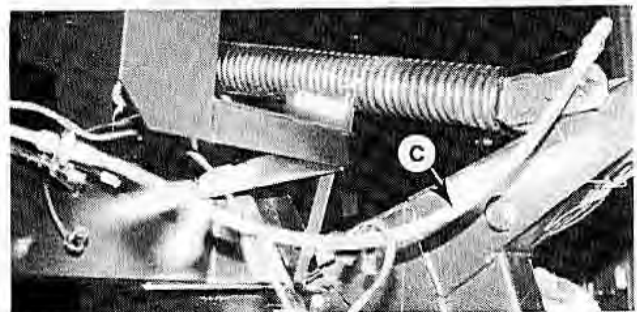

REPLACE DRAPER DRIVE HOSE
(960/962 Double Delivery Headers)

ASSEMBLY

Preparing 960/962 Harvest Header for 9000 Tractor

1. Attach lift linkage supports to lower header legs with 5/8 locknut at (A).

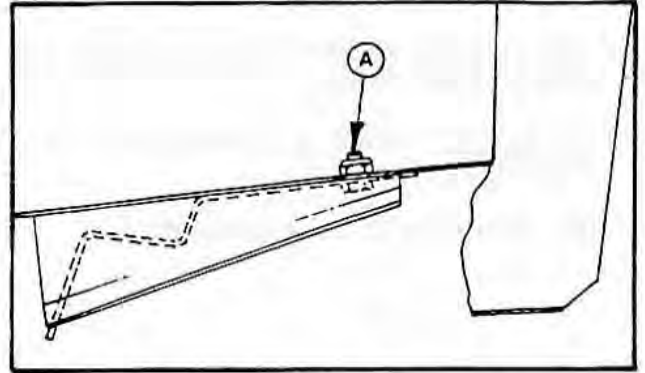

ATTACH LINKAGE SUPPORTS TO HEADER LEGS

2. Attach connector shaft assembly (B) to header frame tube as follows:
 - With carriage bolt and nut installed loosely in plate (C) of shaft assembly, engage head of carriage bolt in key-hole slot in header frame tube near left leg.
 - Holding left side of shaft assembly slightly away from tube, slide shaft assembly to the left, so bolt enters narrow section of key-hole slot and plate (D) aligns with outboard side of lug welded to header frame tube.
 - Fasten plate (D) to lug with two 3/8 x 1 inch carriage head bolts and flange locknuts.
 - Tighten nut to secure shaft assembly at plate (C).
 - Attach header driveline to outboard end of connector shaft. (For 962, attach clamp yoke end of driveline to header drive shaft.)

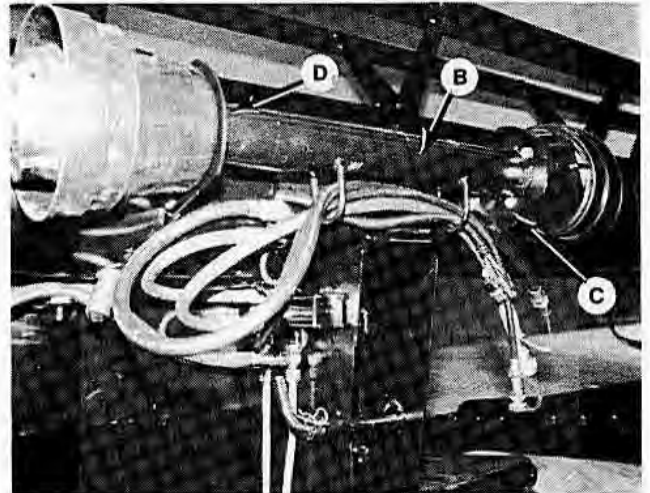

ATTACH CONNECTOR SHAFT TO HEADER FRAME TUBE

3. Move reel drive couplers mounting plate from side of header leg to position (E) shown.
IMPORTANT: Damage to couplers may occur if plate is not re-positioned.

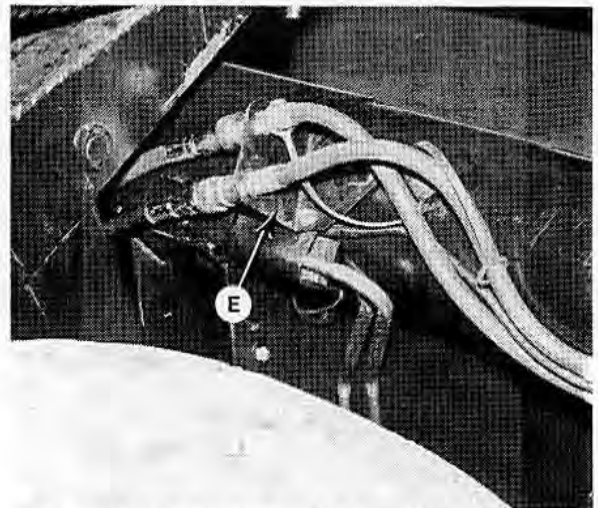

RE-POSITION REEL DRIVE COUPLERS

ASSEMBLY

Preparing 960/962 Harvest Header for 9000 Tractor (continued)

4. Attach reel lift hose and coupler (supplied in adapter kit) as follows:

21', 25' & 30': Attach to hydraulic line (F) at header left leg.

36': Attach to hose (G) at header left leg.

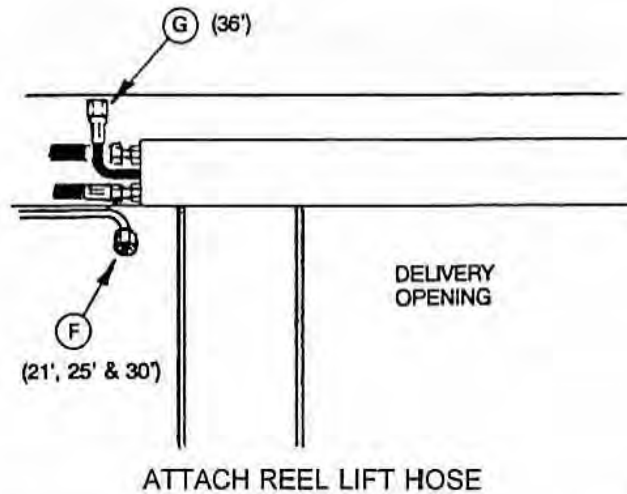

5. Double Delivery Headers: Release draper return hose (with blue male coupler) from hose clamp (H). Route hose through loops (J) on connector shaft as shown.

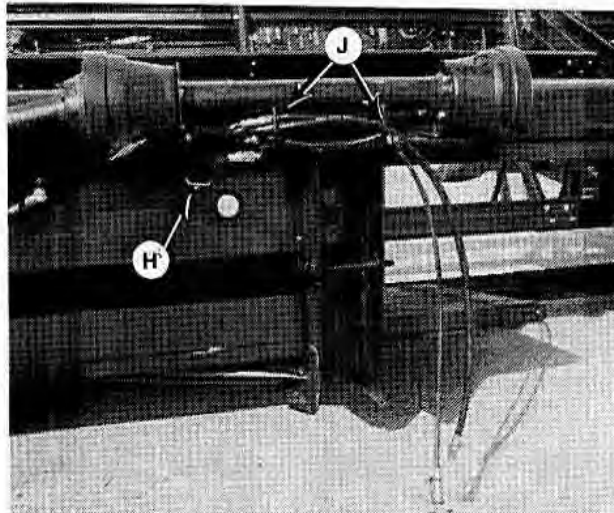

RELEASE HOSE FROM CLAMP -
D.D. HEADERS

Triple Delivery Headers: Release draper pressure hose (with orange female coupler) from hose clamp (K) and route through loops (J) on connector shaft as shown. Pull draper return hose (with blue male coupler) out from behind short hose and route through loops (J).

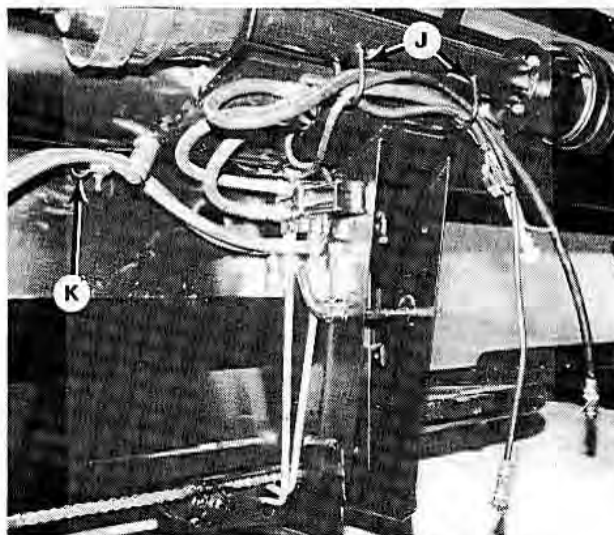

RE-ROUTE DRAPER HOSES -
T.D. HEADERS

ASSEMBLY

Preparing 972 Harvest Header (21' to 36') for 9000 Tractor

1. Attach lift linkage supports (A) to lower header legs with 5/8 x 1½ carriage bolts, lockwashers and nuts.
2. Attach center section of wear plate (D) to cutterbar at delivery opening. Longer guard bolts are positioned at the correct locations.
3. Attach skid shoes (B) at header legs with 5/8 x 1½ carriage bolts and flange nuts.
4. Attach reel lift coupler to hose at header left leg.

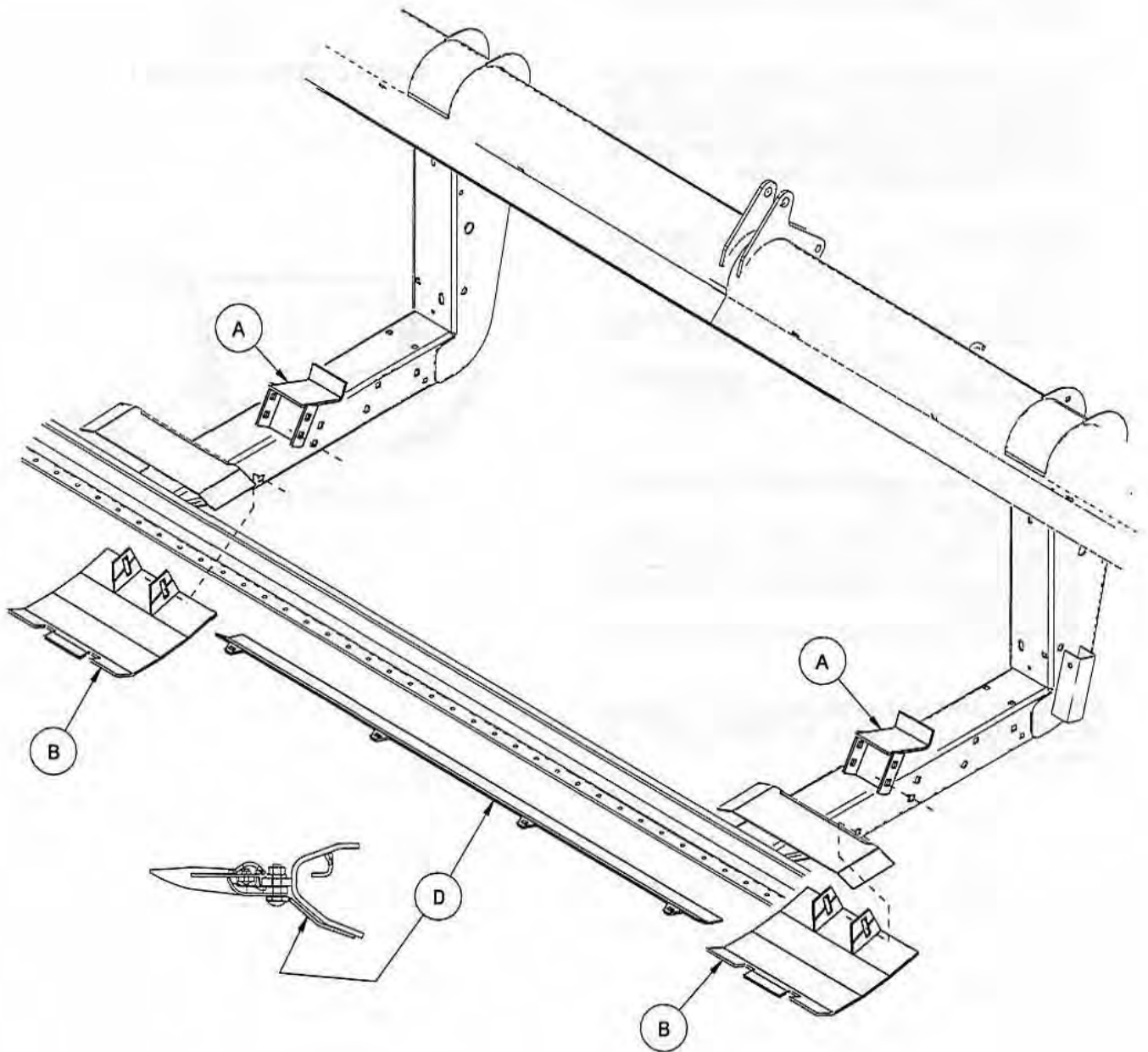

21' to 36' 972 HEADERS - WINDROWER COMPLETION PACKAGE

ASSEMBLY

Radio Installation

Provision has been made for easy installation of a radio:

- Remove decal (A) and remove radio cut-out piece from headliner by cutting through four tabs.
- Install radio in cut-out.
- Remove wiper motor cover (B) for access to roof inner area. Attach nut (E) to secure rear of radio body.
NOTE: For short body radio, bend support (F) as required.
- A six-pin connector for the radio is included in the wiring harness. In order to mate properly with this connector, the radio must have a six-pin connector (Packard #2977042) and have a terminal arrangement as follows:

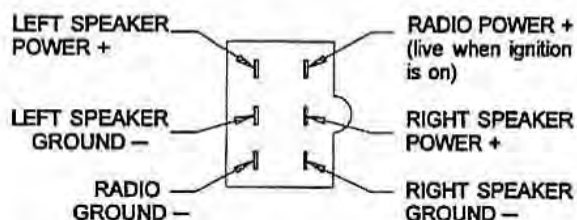

- There are two additional wires in the wiring harness at the radio:
Circuit 503, Red with 1/4" female blade terminal. This is a live wire provided for powering a radio clock/memory, if these exist on your radio.
Circuit 315, Black ground wire attaches to radio body.

NOTE: An approved radio package is available from Radio Engineering Industries (REI) of Omaha, Nebraska.

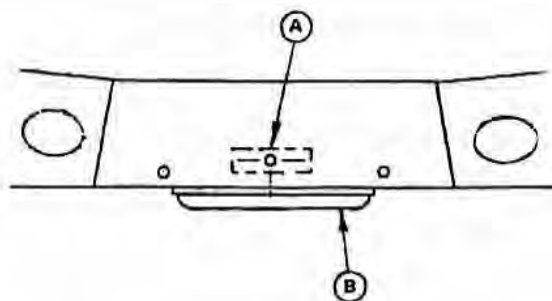

RADIO CUTOUT LOCATION

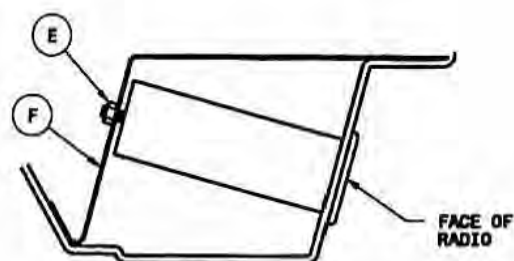

SUPPORT RADIO BODY

ASSEMBLY

Two-Way Radio Installation

At the right rear cab post, just below the side window rear latch, you will find a red wire provided for installation of a two-way radio. The other end of this wire is at the starter.

- Install an in-line fuse and 3/8 ring terminal on starter end of wire and connect at BATT terminal on starter.
- Install the appropriate connector at the radio end of wire.

To mount antenna to cab roof:

- Remove console lower panel (to right of operator's seat) and route antenna cable (E) from the radio into the console, following the red power wire.
- Remove instrument panel cover on cab right post. Follow cab wiring harness into headliner.
- Remove wiper motor cover and/or right radio speaker for access to inside of headliner.

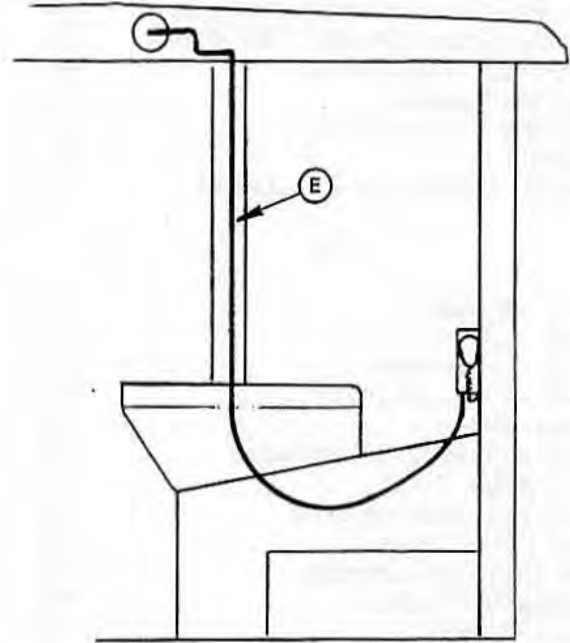

TWO-WAY RADIO ANTENNA ROUTING

Swath Roller

A swath roller can be attached at two bottom bolts (A) on walking beam pivot plate.

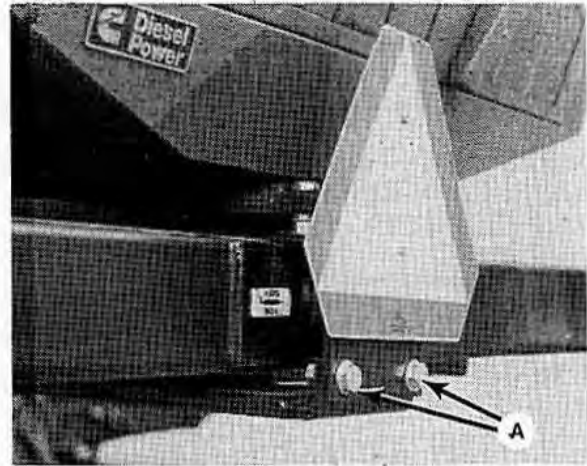

ATTACH SWATH ROLLER HERE

INDEX

<u>A</u>	PAGE	<u>E</u>	PAGE
Air Cleaner - Diesel	62	Electrical Schematics	80
Air Conditioning System Maintenance	108	Electrical System	73
Air Intake Screen Cleaner (Attachment)	129	Electrical System Trouble Shooting	122
Air Removal - Fuel System	67	Emergency Exit	35
Alternator/Regulator	76	Engine Compartment Side Panels	57
Anti-freeze Concentration	70	Engine - Diesel	58
Assembly	132	Engine Inspection	61
Assembly Checks and Adjustments	135	Engine Specifications	12
		Engine Speed - Throttle Rod Adjustment	60
		Engine Trouble Shooting	117
		Exhaust System	69
		<u>F</u>	
<u>B</u>		Filter - Air Cleaner, Diesel	62
Battery - Booster	75	Filter - Cab Fresh Air Intake	108
Battery - Charging	75	Filter - Cab Return Air	109
Battery - Maintenance	74	Filter - Engine Oil, Diesel	59
Battery - Preventing Damage	74	Filter - Fuel, Diesel	66
Battery - Safety	73	Filter - Hydraulic Oil	85
Battery - Selection & Installation	134	Forked Tail-Wheel Casters (Option)	129
Belt - Header Drive	90	Fuel Recommendations	53
Belt Guides - Header Drive	92	Fuel Sediment Bowl	65
Belts - Diesel Engine	59	Fuel Storage	64
Bevel Gear Box Lubricant	90	Fuel System - Diesel	64
Bleeding Fuel System	67	Fuel Tank Venting	64
Break-In Period	25	Fuel/Water Separator	65
Bulbs - Replacement	77	Fuses - see Circuit Breakers	79
Buzzers - System Malfunction	17		
		<u>G</u>	
<u>C</u>		Gauges	17
Cab Air System	108	Greasing the Windrower Tractor	55
Cab Air System: Compressor Diagnostics	110	Ground Speed Control Lever	20
Cab Air System: Refrigerant Oil	110	Ground Speed Lever Friction Device	102
Cab Air System Trouble Shooting	114		
Cab Temperature Controls	19		
Capacities - Systems	55		
Charge Pump Pressure	94		
Circuit Breakers	79		
Condenser - A/C, Cleaning	72		
Conveyor Speed Control	21		
Coolant - Changing	71		
Coolant Level	70		
Coolant Recommendations	53		
Cooler - Hydraulic Oil	72		
Coolers - Cleaning	72		
Cooling System	70		
Cylinder Control Valve Relief Pressure	86		
		<u>H</u>	
<u>D</u>		Harvest Header - Special Preparations	136
Draper Speed Control	21	Header Angle	43
Driving Forward	31	Header Attaching	36
Driving - On Roads	45	Header & Reel Lift Hydraulics	86
Driving Rearward	32	Header & Reel Lift Schematic	87
Driving Safety	30	Header Controls	21
Driving - Spin Turn	33	Header Detaching	40
		Header Drive Belt	90
		Header Drive Belt Pulley Alignment	91
		Header Drive Hydraulic Flow Control	88
		Header Drive Hydraulic Schematic	89
		Header Drive Relief Pressure	88
		Header Drive Switch	21
		Header Drive Trouble Shooting	126
		Header Drop Module (Attachment)	129
		Header Flotation	45
		Header Levelling	44
		Header Lift Cylinder Stops	42
		Header Operation	42
		Hydraulic System Maintenance	84
		Header Hydraulics Trouble Shooting	126

INDEX

I	PAGE
Ignition Switch	18

J

Jacking Procedure	106
-------------------------	-----

L

Lamps, Servicing	77
Leaving the Windrower	35
Lights - Control of	18
Lubricant Recommendations	53

M

Maintenance Record	113
Maintenance Schedule	111
Monitors - Machine	17
Muffler	69

N

Neutral Lock and Steering Checks	96
Neutral Lock and Steering Troubleshooting	99
Neutral Set-Up Procedure	100

O

Oil - Diesel Engine	58
Oil - Hydraulic	84
Operator's Station	17
Options and Attachments	129

P

Park Brake Lever, Adjustment	107
Park Brake Lever, Operation	20
Park Brake Trouble Shooting	128
Power Wheels	105
Power Wheel Gear Lubricant	54
Pre-Starting Checks: Annual	26
Pre-Starting Checks: Daily	27
Pulley Shield Adjustment (Header Drive)	93

R

Radiator Cap	70
Radiator Screen	72
Radio Approved Source	129
Radio Installation	140
Reel Height Control	22
Reel Speed Control	21
Refrigerant Charge	109
Refuelling Windrower	64
Responsibilities - Owner/Operator	24
Roller Installation Location	141

S	PAGE
---	------

Safety:	
Alert Symbol	6
Battery	73
Driving the Windrower	30
Emergency Exit	35
General Farm	9
Header Lift Cylinder Stops	42
High Pressure Fluids	68,84
Leaving the Windrower	35
Neutral Lock	96
Pre-Starting Checks: Annual	26
Pre-Starting Checks: Daily	27
Refrigerant	108
Service Procedures	52
Signal Words	6
Signs	7
Start-Up Procedure	28
Stopping the Windrower	34
Stopping the Engine	34
Storage Procedure	51
Transporting	46
Your Responsibilities	24
Screens - Cleaning	72
Seat - Operator's	23
Seat - Trouble Shooting	128
Serial Number Locations	5
Service Procedures	52
Specifications:	
Engines	12
Hardware Torques	13
Hydraulic Fitting Torques	14
Windrower Tractor	11
Speed Range Control	20
Speedometer / Acre Counter (Attachment)	129
Start-Up Procedure	28
Steering and Ground Speed	
Trouble Shooting	125
Steering Wheel	20
Stopping Procedure - Engine	34
Stopping Procedure - Windrower	34
Storage Procedure	51
Symbol Definitions - Monitors & Controls	15

T

Tachometer (Attachment)	129
Throttle Lever	20
Throttle Rod Adjustment	60
Tire Inflation Pressures	11
Tire Installation	132
Tire Service	106
Towing With Trailer	47
Towing Without Trailer	49
Traction Drive Hydraulic Schematic	95
Traction Drive: Neutral Lock	96
Traction Drive Trouble Shooting	123
Transmission Two-Speed Linkage	103
Transmission Relief Pressure	94
Transporting Windrower	46

INDEX

<u>I</u> cont'd.	PAGE
Trouble Shooting	114
Trouble Shooting: A/C Diagnostics	110
Two-Way Radio Installation	141

U

Unloading Preparations	130
Unloading With One Forklift	131
Unloading With Two Forklifts	130

V

Valve Tappets - Engine	61
----------------------------------	----

W

Warning Lights - System Malfunction	17
Weight - Adding to Rear of Tractor	39
Wheel Bolts	105
Wheels and Tires	105
Window Operation	35
Windrower Controls	20
Wiper Operation	19

Self-Propelled Windrower Pre-Delivery Checklist

Perform these checks and make adjustments as required prior to delivery to your customer. See the Operator's Manual for adjustment details.



CAUTION: Carefully follow the instructions given. Be alert for safety related messages which bring your attention to hazards and unsafe practices.

Serial Numbers: WINDROWER: _____ ENGINE: _____

- Check for damage or missing parts. Remove plastic or tape from air cleaner intake and muffler exhaust.
- Turn SMV sign reflective side out.
- Remove shipping skid shoes from front legs and shipping support from walking beam (yellow parts).
- Install tires and torque to specifications. Check tire air pressures and adjust as required.
- Check power wheel lubricant level.
- Check engine coolant level and strength at reserve tank.
- Check air cleaner and connections.
- Check hydraulic oil level and check for leaks along lines.
- Check engine oil level.
- Check fuel sediment bowl for water & foreign material. Drain and clean as necessary. Add fuel.
- Check bevel gear box lubricant level.
- Check linkage operation at injector pump.
- Check tension of engine belts.
- Install a properly sized and fully charged battery and connect cables.
- Lubricate the machine completely.
- Check neutral start system properly adjusted.
- Check and adjust park brake tension.

START ENGINE AND RUN TO OPERATING TEMPERATURE.

- Check instrument console gauges and interior lights for operation.
- Check engine oil pressure indicator light at instrument console.
- Check alternator charge rate at instrument console.
- Check fuel gauge for operation.
- Check maximum (no load) engine speed: 2425 - 2475 RPM Turbo / 2645 - 2705 RPM N.A.
- Check air conditioning functioning properly.
- Check exterior lights for operation.
- Open heater valve at engine compartment if cab heat required.
- Attach header and complete the Header Pre-Delivery Checklist.
- Check that all header controls operate correctly and freely.

Date Checked: _____

Checked by: _____

CALIFORNIA

Proposition 65 Warning

Diesel engine exhaust and some of its constituents are known to the State of California to cause cancer, birth defects, and other reproductive harm.

MacDon

The Quiet Leader