



**Model 942  
Multi-Crop Header  
and 941 Hay Conditioner**

**OPERATOR'S  
MANUAL**

**MacDon Industries Ltd.**

680 Moray Street  
Winnipeg, Manitoba R3J 3S3  
(204) 885-5590, Fax 832-7749



**MacDon, Inc.**

9700 N.W. Conant Avenue  
Kansas City, Missouri 64153-1832  
(816) 891-7313, Fax 891-7323



# INTRODUCTION

Your new Model 942 Multi-Crop Header, teamed with the MacDon Self Propelled Windrower power unit; is designed to cut, and lay in windrows, a wide variety of grain, hay and specialty crops. Windrowing allows starting the harvest earlier, protects the crop from wind damage, and gives you more flexibility in scheduling combine time.

The header, power unit, and optional hay conditioner provide a package which incorporates many features and improvements in design requested by Owner/Operators like yourself.

**NOTE:** This manual contains information on the 942 Multi-Crop Header and optional Hay Conditioner. It is to be used in conjunction with the Self Propelled Windrower Operator's manual which provides information on the power unit (tractor).

**CAREFULLY READ BOTH MANUALS TO BECOME FAMILIAR WITH ALL RECOMMENDED PROCEDURES BEFORE ATTEMPTING TO UNLOAD, ASSEMBLE OR USE THE WINDROWER.**

Use this manual as your first source of information about the machine. If you follow the instructions given in this manual, your Windrower will work well for many years.

The manual contains instruction for "Safety", "Operation" and "Maintenance/Service". In addition, "Unloading and Assembly" information is given towards the back of this book.

Use the Table of Contents and the Index to guide you to specific areas. Study the Table of Contents to familiarize yourself with how the material is organized.

Keep this manual handy for frequent reference and to pass on to new operators or owners. Call your Windrower dealer if you need assistance, information, or additional copies of the manuals.

**NOTE:** Right hand (R/H) and left hand (L/H) designations are determined from the operator's position, facing forward.

# TABLE OF CONTENTS

	PAGE
INTRODUCTION .....	1
SERIAL NUMBER LOCATIONS .....	4
<b>SAFETY</b>	
Safety Alert Symbol .....	5
Signal Words .....	5
Safety Signs .....	6
General Farm Safety .....	7,8
<b>SPECIFICATIONS</b>	
Multi-Crop Header and Attachments .....	9
Hardware Torque Specifications .....	10
Hydraulic Fittings Torque Specifications .....	11
<b>OPERATION</b>	
Your Responsibilities as an Owner/Operator .....	12
To the New Operator .....	12
Attaching the Hay Conditioner .....	13-15
Detaching the Hay Conditioner .....	15,16
Break-In Period .....	17
Pre-Starting Checks: Annual .....	18
Pre-Starting Checks: Daily .....	19
Operate Correctly .....	19
Header Controls .....	20
Header Lift Cylinder Stops .....	20
Reel Props .....	20
Operating Variables .....	21
Cutting Height .....	22
Skid Shoes .....	22
Ground Speed .....	23
Reel Speed .....	24
Reel Height .....	24
Reel Position - Fore & Aft .....	25
Pick-Up Reel Adjustments .....	26,27
Auger Speed .....	28
Header Angle .....	28
Header Flotation .....	28
Upper Cross Auger (Optional) .....	29
Forming Rods (Optional) .....	29
Hay Conditioner Roll Intermesh .....	30
Hay Conditioner Roll Tension Springs .....	30
Hay Conditioner Ground Clearance .....	31
Hay Conditioner Float .....	32
Hay Conditioner Forming Shields .....	33
Haying Tips: .....	34
Topsoil Moisture .....	34
Climate and Topography .....	34
Windrow Characteristics .....	35
Raking and Tedding .....	35
Chemical Drying Agents .....	35
Grain Windrow Characteristics .....	35
Unplugging the Header .....	36
Transporting the Header .....	37
Lifting the Header in Working Position .....	37
Storage Procedure .....	38



# TABLE OF CONTENTS

	PAGE
<b>MAINTENANCE/SERVICE</b>	
Service Procedures .....	39
Recommended Lubricants .....	40
Enclosed Drive Lubricant Capacities .....	40
Sealed Bearing Installation .....	40
Greasing the Header and Hay Conditioner .....	41-43
<b>Sickle and Sickle Drive</b>	
Sickle Lubrication .....	44
Sickle Sections .....	44
Sickle Removal and Installation .....	44,45
Sickle Head Needle Bearing Installation .....	45
Sickle Guards and Hold-Downs .....	46
Sickle Timing .....	47
Changing Double Sickle Speed .....	47
Tightening Double Sickle Drive Belts .....	48
Tightening Single Sickle Drive Belt .....	48
Wobble Box Maintenance .....	49
<b>Reel and Reel Drive</b>	
Reel Finger Replacement .....	50
Centering the Reel .....	50
Reel Clearance to Cutterbar .....	51
Reel Drive Chain Tension .....	51
Reel Drive Chain Lubrication .....	51
<b>Augers and Auger Drive</b>	
Stripper Bars .....	52
Auger Removal .....	52
Front Augers Drive Chain Tension .....	53
Front Augers Drive Chain Lubrication .....	53
<b>Hydraulic System</b> .....	
<b>Hay Conditioner</b>	
Hay Conditioner Drive Chain Lubrication .....	54
Hay Conditioner Drive Chain Tension .....	54
Hay Conditioner Roll Timing .....	54
<b>Maintenance Schedule</b> .....	55,56
<b>Maintenance Record</b> .....	57
<b>TROUBLE SHOOTING</b> .....	58-64
<b>ATTACHMENTS</b>	
Upper Cross Auger .....	65
Hay Conditioner .....	65
Forming Rods .....	65
Steel Pick-Up Fingers .....	66
Stub Guard Conversion Kit .....	66
Rear Auger Extensions .....	66
<b>UNLOADING AND ASSEMBLY</b>	
Unloading the Header .....	67
Lower Header to Ground .....	68
Assemble and Mount Pick-Up Reel .....	68
Adjust Reel Clearance to Cutterbar .....	69
Attach Dividers .....	69
Attach Forming Rods .....	70
Attach Header and Bleed Hydraulic System .....	70
Prepare Header and Tractor for Hay Conditioner .....	71,72
Install Side Deflectors on Hay Conditioner Forming Shields .....	73
Attach Hay Conditioner Forming Shields .....	73,74
Install Conditioner Drive Belts .....	74
Adjustments and Checks .....	74
<b>INDEX</b> .....	75,76

## SERIAL NUMBER LOCATIONS

Record the serial numbers in the space provided.

Multi-Crop Header: \_\_\_\_\_

Plate is located on top of left hand end sheet.

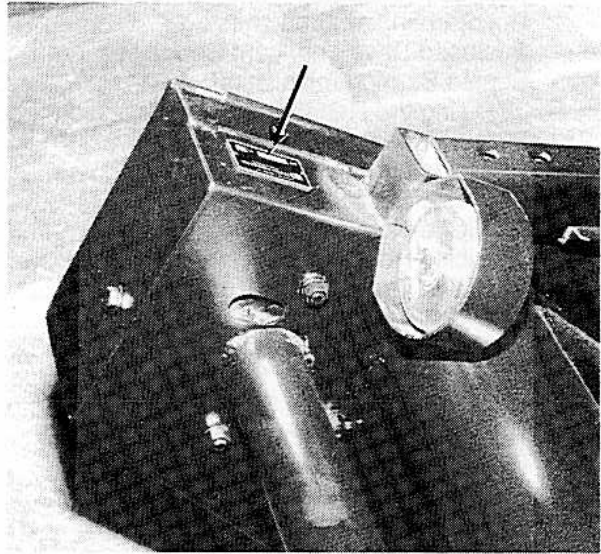

MULTI-CROP HEADER  
SERIAL PLATE LOCATION

Hay Conditioner: \_\_\_\_\_

Plate is located at rear left side of top sheet.

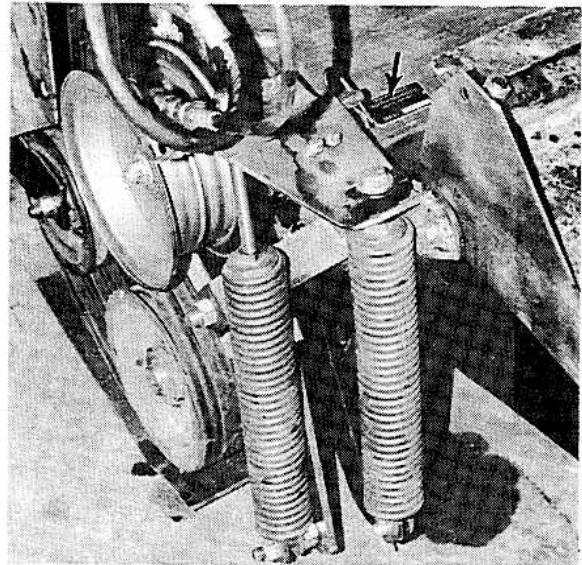

HAY CONDITIONER  
SERIAL PLATE LOCATION

**NOTE:** When ordering parts and service, be sure to give your dealer the complete and proper serial number.

## SAFETY

### SAFETY ALERT SYMBOL



This safety alert symbol indicates important safety messages in this manual and on safety signs on the header.

This symbol means: **ATTENTION!  
BECOME ALERT!  
YOUR SAFETY IS INVOLVED!**

Carefully read and follow the safety message accompanying this symbol.

Why is SAFETY important to you?

#### 3 BIG REASONS

- ACCIDENTS DISABLE AND KILL
- ACCIDENTS COST
- ACCIDENTS CAN BE AVOIDED

### SIGNAL WORDS

Note the use of the signal words DANGER, WARNING and CAUTION with safety messages. The appropriate signal word for each message has been selected using the following guidelines:



- an immediate and specific hazard or forbidden practice which **WILL** result in severe personal injury or death if the message is not followed.



- a specific hazard or unsafe practice which **COULD** result in severe personal injury or death if the message is not followed.



- unsafe practice which **COULD** result in personal injury if the message is not followed, or a reminder of good safety practices.

# SAFETY

## SAFETY SIGNS

- The safety signs reproduced below appear on the header at the locations listed.
- Keep safety signs clean and legible at all times.
- Replace safety signs that are missing or become illegible.
- If original parts on which a safety sign was installed are replaced, be sure the repair part also bears the current safety sign.
- Safety signs are available from your Dealer Parts Department. The part number is printed in the lower R/H corner of each safety sign.

### To install safety signs:

1. Be sure the installation area is clean and dry.
2. Decide on the exact location before you remove the decal backing paper.
3. Remove the smaller portion of the split backing paper.
4. Place the sign in position and slowly peel back the remaining paper, smoothing the sign as it is applied.
5. Small air pockets can be smoothed out or pricked with a pin.



DRIVELINE

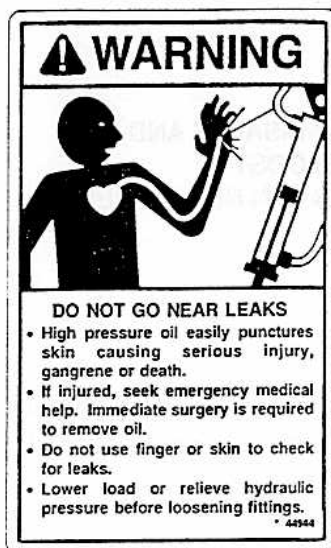

LEFT & RIGHT REEL SUPPORT ARMS

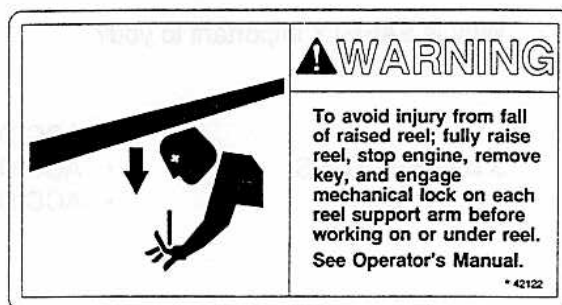

LEFT & RIGHT REEL SUPPORT ARMS



DRIVE SHIELDS

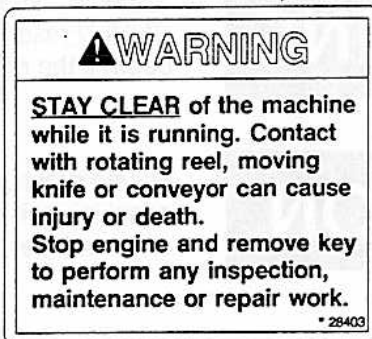

LEFT & RIGHT REEL ENDS



UPPER CROSS AUGER END SHIELDS

# SAFETY

## GENERAL SAFETY



The following are general farm safety precautions that should be part of your operating procedure for all types of machinery.

### 1. Protect yourself.

When assembling, operating and servicing machinery, wear all the protective clothing and personal safety devices that COULD be necessary for the job at hand. Don't take chances.

You may need:

- a hard hat.
- protective shoes with slip resistant soles.
- protective glasses or goggles.
- heavy gloves.
- wet weather gear.
- respirator or filter mask.
- hearing protection. Be aware that prolonged exposure to loud noise can cause impairment or loss of hearing. Wearing a suitable hearing protective device such as ear muffs (A) or ear plugs (B) protects against objectionable or loud noises.

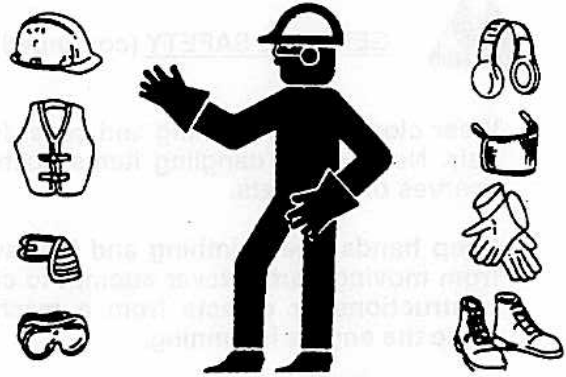

PROTECT YOURSELF



PROTECT AGAINST NOISE

### 2. Provide a first-aid kit for use in case of emergencies.

### 3. Keep a fire extinguisher on the machine. Be sure the extinguisher is properly maintained and be familiar with its proper use.

### 4. Keep young children away from machinery at all times.

### 5. Be aware that accidents often happen when the operator is tired or in a hurry to get finished. Take the time to consider the safest way. Never ignore warning signs of fatigue.



BE PREPARED FOR EMERGENCIES



# SAFETY



## GENERAL SAFETY (continued)

6. Wear close-fitting clothing and cover long hair. Never wear dangling items such as scarves or bracelets.
7. Keep hands, feet, clothing and hair away from moving parts. Never attempt to clear obstructions or objects from a machine while the engine is running.
8. Keep all shields in place. Never alter or remove safety equipment. Make sure driveline guards can rotate independently of the shaft and can telescope freely.
9. Use only service and repair parts made or approved by the equipment manufacturer. Substituted parts may not meet strength, design, or safety requirements.
10. Do not modify the machine. Unauthorized modifications may impair the function and/or safety and affect machine life.
11. Stop engine and remove key from ignition before leaving operator's seat for any reason. A child or even a pet could engage an idling machine.
12. Keep the area used for servicing machinery clean and dry. Wet or oily floors are slippery. Wet spots can be dangerous when working with electrical equipment. Be sure all electrical outlets and tools are properly grounded.
13. Use adequate light for the job at hand.
14. Keep machinery clean. Straw and chaff on a hot engine are a fire hazard. Do not allow oil or grease to accumulate on service platforms, ladders or controls. Clean machines before storage.
15. Never use gasoline, naphtha or any volatile material for cleaning purposes. These materials may be toxic and/or flammable.
16. When storing machinery, cover sharp or extending components to prevent injury from accidental contact.



NEVER WEAR LOOSE  
OR DANGLING CLOTHES

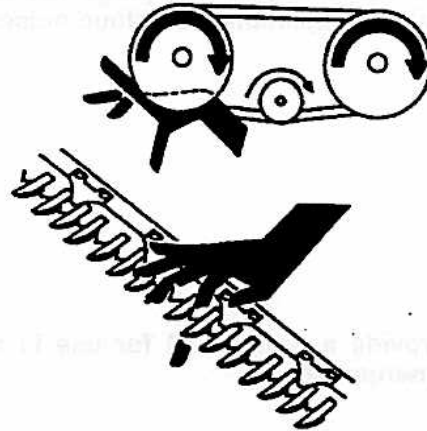

KEEP AWAY FROM MOVING PARTS



KEEP SERVICE AREA CLEAN AND DRY

## SPECIFICATIONS

### 942 Multi-Crop Header

AVAILABLE SIZES	12 ft. Single Sickle Header 15 ft. Double Sickle Header 18 ft. Double Sickle Header
CUT WIDTH	12 ft. 9 in. (3.89 m) / 15 ft. 9 in. (4.80 m) / 18 ft. 9 in. (5.71 m)
SINGLE SICKLE DRIVE	"C" belt to enclosed oil bath wobble box
DOUBLE SICKLE DRIVE	Timing belts to enclosed oil bath wobble boxes
SINGLE SICKLE SPEED	1450 strokes per minute
DOUBLE SICKLE SPEED	1875* or 1450 strokes per minute (* - factory assembled)
SICKLE TYPE	Over-serrated (bolted) sections, double heat-treated guards
CUTTERBAR RANGE	2.4 in. (60 mm) below ground to 43.3 in. (1100 mm) above ground (measured to guard tip)
GUARD ANGLE	6° to 13° below horizontal (cutterbar on ground)
DELIVERY OPENING WIDTH	
12 FT.	60 in. (1525 mm)
15 & 18 FT.	64 in. (1625 mm)
DELIVERY OPENING HEIGHT	31 in. (790 mm) to 35 in. (890) (cutterbar on ground)
AUGER DRIVE	Hydraulic to chain final drive
AUGER SPEED	175 - 500 rpm (variable from cab)
AUGER TYPE	Open center, dual cantilevered, overshot
AUGER SIZE	Front - 9" (230 mm) Rear - 12" (305 mm)
REEL DRIVE	Hydraulic to chain final drive
REEL SPEED	20 to 60 rpm (variable from cab)
REEL TYPE	5 or 6 Bat cam action Pick-Up Reel Fingers: Plastic (standard) or Steel (optional)
WEIGHT (with reel)	
12'	1945 lbs. (880 kg)
15'	2410 lbs. (1095 kg)
18'	2700 lbs. (1225 kg)

### Options

UPPER CROSS AUGER DRIVE	Hydraulic
SPEED	140 to 390 rpm (varies with dual augers)
TYPE	9 in. diameter, center feed
HAY CONDITIONER TYPE	Crimper - Intermeshing steel rolls, Header mounted
ROLL WIDTH	65 in. (1650 mm)
ROLL DIAMETER	8 in. (200 mm)
SPEED	910 rpm
WEIGHT	805 lbs. (365 kg)

SPECIFICATIONS AND DESIGN ARE SUBJECT TO CHANGE WITHOUT NOTICE OR OBLIGATION TO REVISE UNITS PREVIOUSLY SOLD.

# TORQUE SPECIFICATIONS

## CHECKING BOLT TORQUE

The tables shown below give correct torque values for various bolts and capscrews. Tighten all bolts to the torques specified in chart unless otherwise noted. Check tightness of bolts periodically, using bolt torque chart as a guide. Replace hardware with the same strength bolt.

## ENGLISH TORQUE SPECIFICATIONS

Bolt Diameter "A"	Bolt Torque *					
	SAE 2		SAE 5		SAE 8	
	N.m	(lb-ft)	N.m	(lb-ft)	N.m	(lb-ft)
1/4"	8	(6)	12	(9)	17	(12)
5/16"	13	(10)	25	(19)	36	(27)
3/8"	27	(20)	45	(33)	63	(45)
7/16"	41	(30)	72	(53)	100	(75)
1/2"	61	(45)	110	(80)	155	(115)
9/16"	95	(70)	155	(115)	220	(165)
5/8"	128	(95)	215	(160)	305	(220)
3/4"	225	(165)	390	(290)	540	(400)
7/8"	230	(170)	570	(420)	880	(650)
1"	345	(225)	850	(630)	1320	(970)

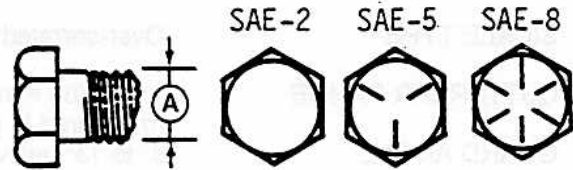

## PICK-UP REEL HARDWARE

The flanged, distorted thread hardware used on the reel has special torque specifications:

3/8" - 30 N.m (22 lb-ft) 5/16" - 16 N.m (12 lb-ft). Measure torque on locknuts.

## METRIC TORQUE SPECIFICATIONS

Bolt Diameter "A"	Bolt Torque			
	8.8		10.9	
	N.m	(lb-ft)	N.m	(lb-ft)
M3	.5	(.4)	1.8	(1.3)
M4	3	(2.2)	4.5	(3.3)
M5	6	(4)	9	(7)
M6	10	(7)	15	(11)
M8	25	(18)	35	(26)
M10	50	(37)	70	(52)
M12	90	(66)	125	(92)
M14	140	(103)	200	(148)
M16	225	(166)	310	(229)
M20	435	(321)	610	(450)
M24	750	(553)	1050	(774)
M30	1495	(1103)	2100	(1550)
M36	2600	(1917)	3675	(2710)

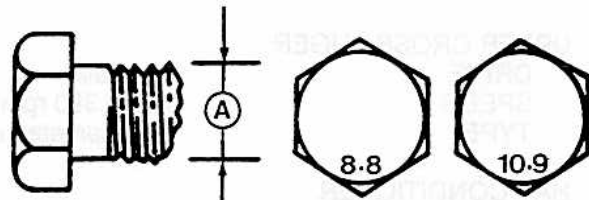

Torque figures indicated above are valid for non-greased or non-oiled threads and heads unless otherwise specified. Therefore, do not grease or oil bolts or capscrews unless otherwise specified in this manual. When using locking elements, increase torque values by 5%.

\* Torque value for bolts and capscrews are identified by their head markings.



# TORQUE SPECIFICATIONS

## TIGHTENING O-RING FITTINGS\*

1. Inspect O-ring and seat for dirt or obvious defects.
2. On angle fittings, back the lock nut off until washer bottoms out at top of groove.
3. Hand tighten fitting until back-up washer or washer face (if straight fitting) bottoms on face and O-ring is seated.
4. Position angle fittings by unscrewing no more than one turn.
5. Tighten straight fittings to torque shown.
6. Tighten angle fittings to torque shown while holding body of fitting with a wrench.

\* The torque values shown are based on lubricated connections as in reassembly.

Thread Size (in.)	Nut Size Across Flats (in.)	Torque Value*		Recommended Turn to Tighten (After Finger Tightening) (Flats) (Turns)	
		(N.m)	(lb-ft)	(Flats)	(Turns)
3/8	1/2	8	6	2	1/3
7/16	9/16	12	9	2	1/3
1/2	5/8	16	12	2	1/3
9/16	11/16	24	18	2	1/3
3/4	7/8	46	34	2	1/3
7/8	1	62	46	1-1/2	1/4
1-1/8	1-1/4	102	75	1	1/6
1-3/8	1-3/8	122	90	1	1/6
1-5/8	1-1/2	142	105	3/4	1/8
1-5/8	1-7/8	190	140	3/4	1/8
1-7/8	2-1/8	217	160	1/2	1/12

## TIGHTENING FLARE TYPE TUBE FITTINGS\*

1. Check flare and flare seat for defects that might cause leakage.
2. Align tube with fitting before tightening.
3. Lubricate connection and hand tighten swivel nut until snug.
4. To prevent twisting the tube(s), use two wrenches. Place one wrench on the connector body and with the second tighten the swivel nut to the torque shown.

\* The torque values shown are based on lubricated connections as in reassembly.

Tube Size OD (in.)	Nut Size Across Flats (in.)	Torque Value*		Recommended Turns to Tighten (After Finger Tightening) (Flats) (Turns)	
		(N.m)	(lb-ft)	(Flats)	(Turns)
3/16	7/16	8	6	1	1/6
1/4	9/16	12	9	1	1/6
5/16	5/8	16	12	1	1/6
3/8	11/16	24	18	1	1/6
1/2	7/8	46	34	1	1/6
5/8	1	62	46	1	1/6
3/4	1-1/4	102	75	3/4	1/8
7/8	1-3/8	122	90	3/4	1/8

## YOUR RESPONSIBILITIES AS AN OWNER/OPERATOR



### **CAUTION:**

1. It is your responsibility to read and understand this manual and the Windrower Operator's Manual completely before operating the header. Contact your dealer if an instruction is not clear to you.
2. Follow all safety messages in the manual and on safety signs on the machine.
3. Remember that **YOU** are the key to safety. Good safety practices protect you and the people around you.
4. Before allowing anyone to operate the machine, for however short a time or distance, make sure they have been instructed in its safe and proper use.
5. Review the manual and all safety related items with all operators annually.
6. Be alert for other operators not using recommended procedures or not following safety precautions. Correct these mistakes immediately, before an accident occurs.
7. Do not modify the machine. Unauthorized modifications may impair the function and/or safety and affect machine life.
8. The safety information given in this manual does not replace safety codes, insurance needs, or laws governing your area. Be sure your machine meets the standards set by these regulations.

### **TO THE NEW OPERATOR**

It's natural for an operator to be anxious to get started with a new machine. Please take the time to familiarize yourself with the header by reading the Operator's Manuals and safety signs before attempting operation.



READ THE OPERATOR'S MANUAL

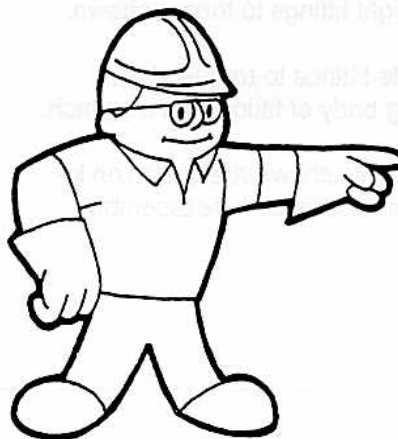

FOLLOW SAFETY RULES

## OPERATION

### ATTACHING THE HAY CONDITIONER

**IMPORTANT:** Before first use, prepare the header and tractor for attachment of hay conditioner. See Assembly section for instruction regarding installation of tractor mounted brackets, drive pulley, etc.

1. Store belt under forming shield as shown (B).
2. Attach header to tractor. See Windrower Tractor or Adapter Operator's Manual.
3. Raise header fully and drive slowly forward, straddling conditioner, until mounting holes in header leg are approximately in line with holes in conditioner mounting arms. Lower header so cutterbar is approximately 8 inches (200 mm) off the ground.
4. Shut off engine and remove key.

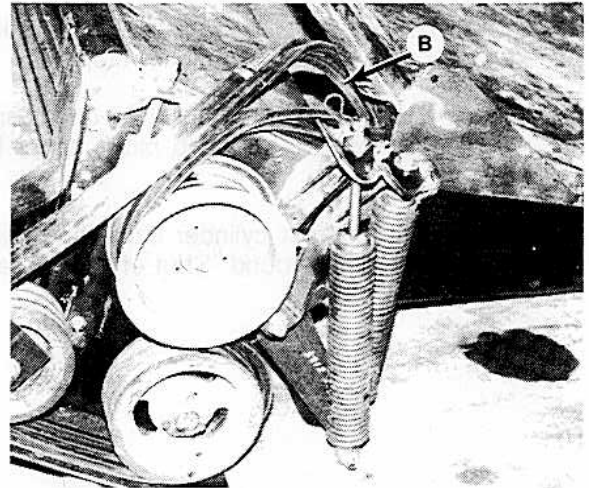

STORE BELT FOR HOOK-UP CLEARANCE

5. Raise left conditioner mounting arm (A) and attach to header leg with one 5/8 x 1 3/4 inch hex head bolt, spacer (C), flatwasher, lockwasher and nut. Repeat at right arm (D).
6. Using a pry bar, raise front of conditioner and attach vertical conditioner support (E) to left header leg with one 5/8 x 1 1/2 carriage bolt, lockwasher and nut. Repeat at right support (F).

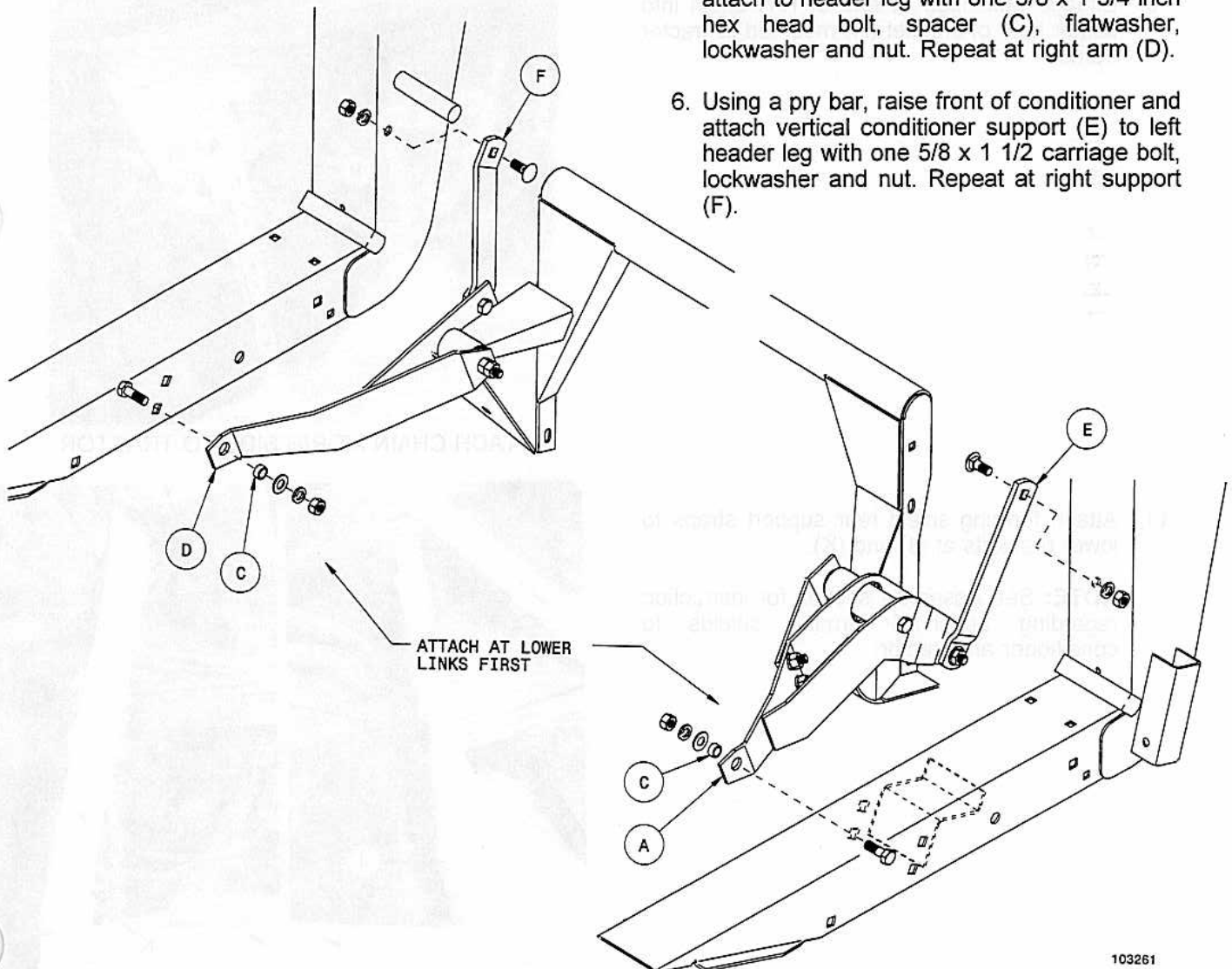

103261

ATTACH CONDITIONER TO HEADER

## OPERATION

### ATTACHING THE HAY CONDITIONER (continued)

7. Raise header fully. Stop engine, remove key and engage header lift cylinder stops.
8. Stack two 2 x 4's under the R/H conditioner shoe as shown at (G). (No block under left side.)
9. Remove header lift cylinder stops and lower cutterbar to the ground. Shut off engine and remove key.

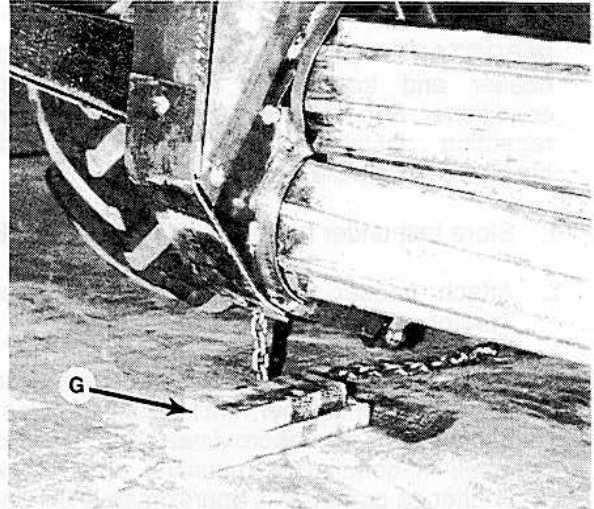

PLACE BLOCK UNDER R/H SHOE

10. Engage bolt head at end of R/H chain into center hole of bracket (H) mounted to tractor frame.

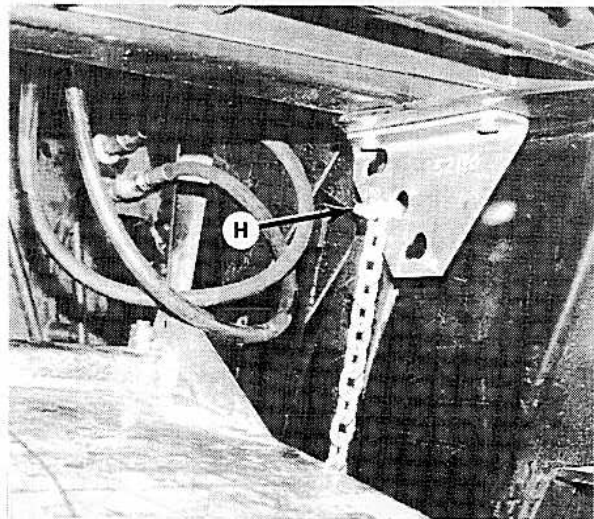

ATTACH CHAIN AT R/H SIDE TO TRACTOR

11. Attach forming shield rear support straps to lower brackets at (J) and (K).

**NOTE:** See Assembly section for instruction regarding attaching forming shields to conditioner and tractor.

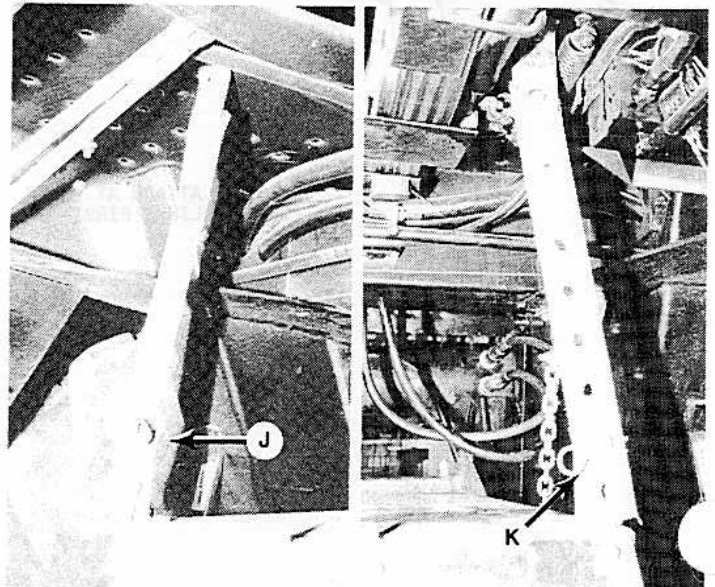

ATTACH SHIELD REAR SUPPORTS



## OPERATION

### ATTACHING THE HAY CONDITIONER (continued)

12. Raise header fully. Stop engine, remove key and engage header lift cylinder stops.
13. Install chain for float spring on pin (L) at left side of conditioner. Connect at the fourth chain link from the spring to start. See Conditioner Float Adjustment under "Operating Variables".
14. Install belts over header pulley (M).  
**NOTE:** There must be 5 inches (125 mm) exposed bolt thread (bottom of pivot to spring plug) on bolt (N) to allow belt installation. Turn bolt (N) counterclockwise to increase exposed thread length.
15. Tighten belts by turning bolt (N) clockwise until spring plug contacts bottom of pivot (P).

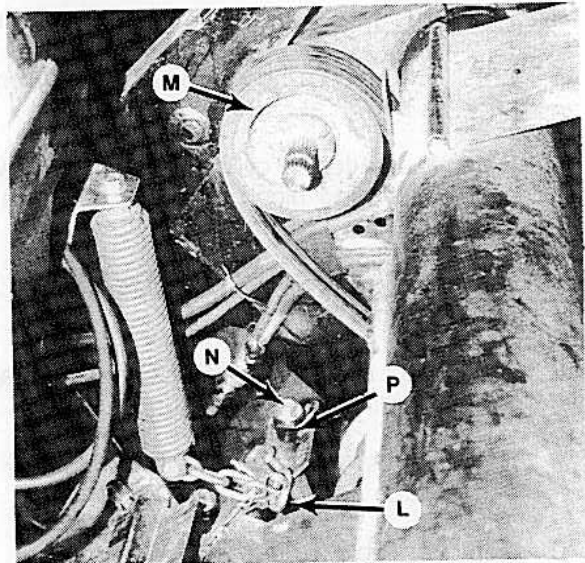

CONNECT FLOAT SPRING &  
INSTALL BELTS

### DETACHING THE HAY CONDITIONER

1. Raise header fully. Stop engine, remove key and engage header lift cylinder stops.
2. Disconnect chain for float spring from pin (L) at left side of conditioner.
3. Turn bolt (N) counterclockwise until there is 5 inches (125 mm) of exposed thread between bottom of pivot to spring plug.
4. Remove belts from pulley on header shaft. Store belts under front edge of forming shield (R).

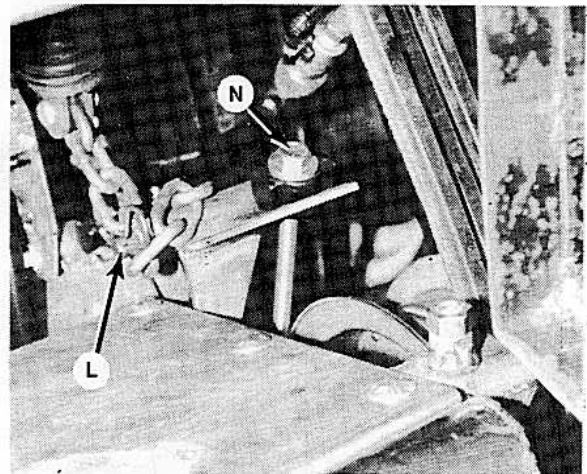

DISCONNECT FLOAT SPRING &  
LOOSEN BELTS

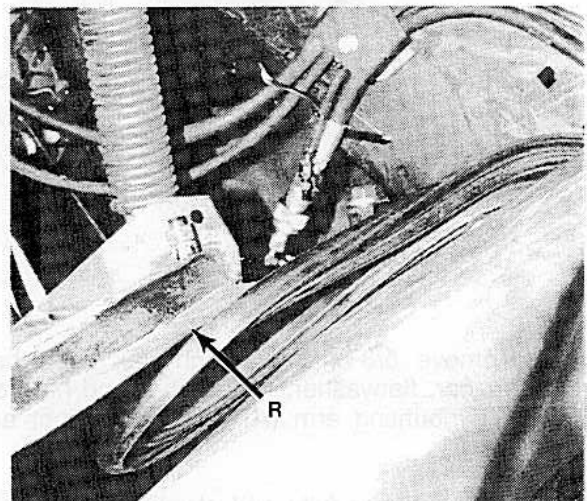

REMOVE AND STORE BELTS

# OPERATION

## DETACHING THE HAY CONDITIONER (continued)

5. Stack two 2 x 4's under the R/H conditioner shoe as shown at (S).
6. Remove header lift cylinder stops and lower conditioner onto block. Shut off engine and remove key.
7. Remove R/H chain from bracket (H) on tractor frame.
8. Disconnect forming shield rear support straps at lower bracket (K), both sides.
9. Raise header fully. Stop engine, remove key and engage header lift cylinder stops.
10. Remove all blocks from under conditioner.
11. Remove header lift cylinder stops and lower cutterbar to ground. Shut off engine and remove key.
12. Remove 5/8 x 1 1/2 inch carriage bolt with lockwasher and nut at left vertical support (E).  
**NOTE:** Pry arm at (G) to loosen top bolt at vertical support.  
Repeat at right vertical support (F).

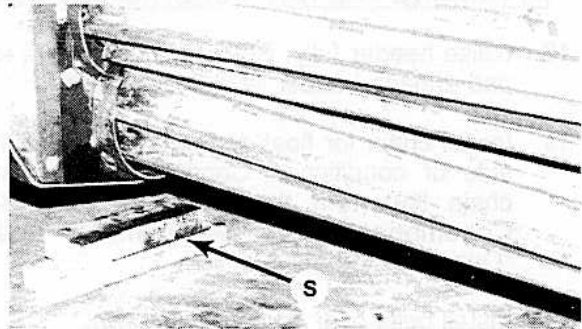

PLACE BLOCK UNDER R/H SHOE

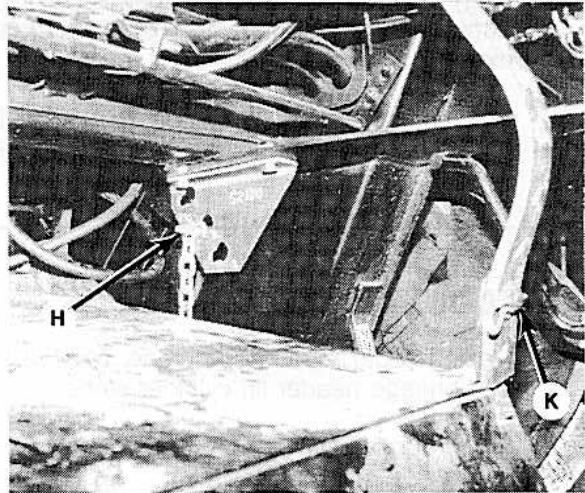

DISCONNECT R/H CHAIN & FORMING SHIELD SUPPORT STRAPS

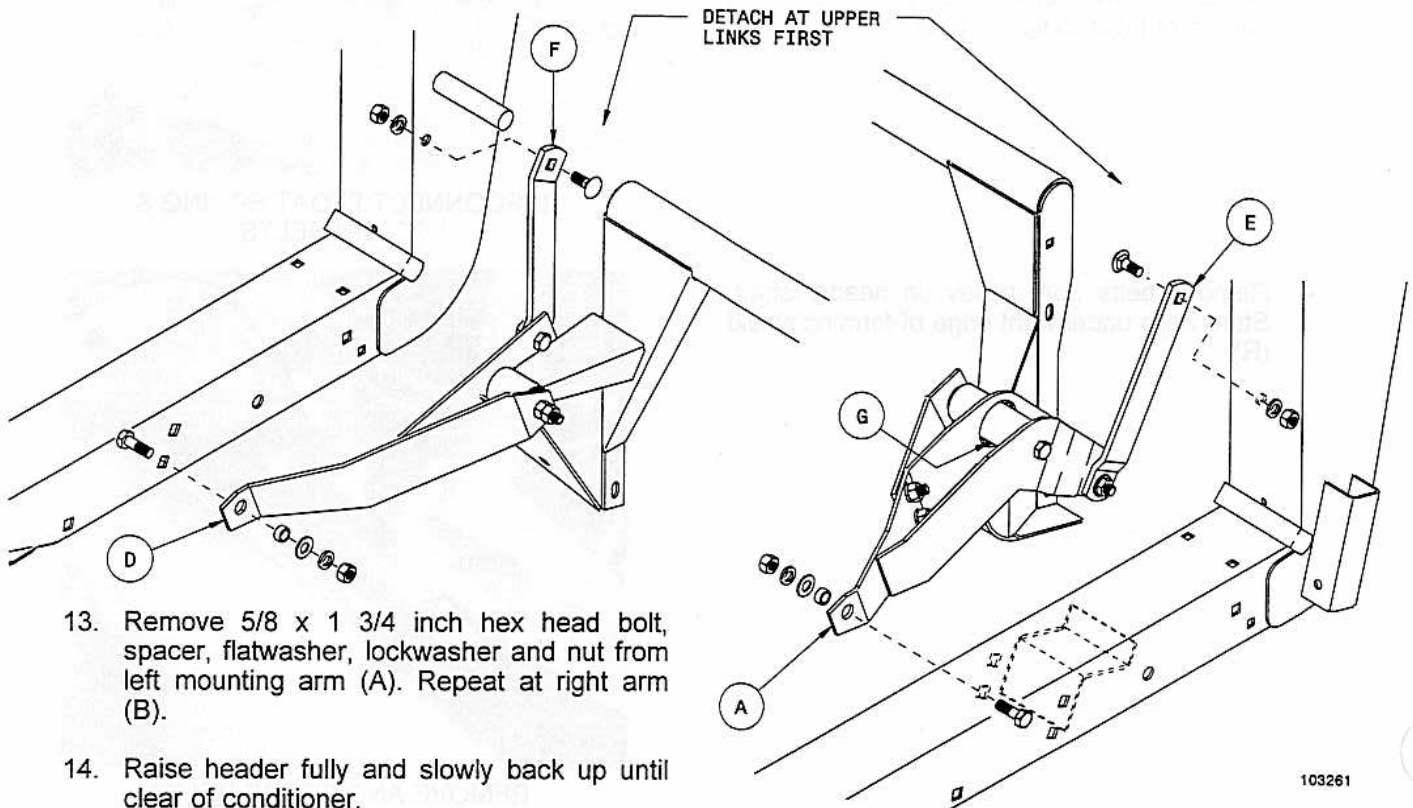

13. Remove 5/8 x 1 3/4 inch hex head bolt, spacer, flatwasher, lockwasher and nut from left mounting arm (A). Repeat at right arm (B).
14. Raise header fully and slowly back up until clear of conditioner.

DETACH CONDITIONER FROM HEADER

103261

# OPERATION

## BREAK-IN PERIOD

1. After attaching header to windrower tractor for the first time, operate the machine slowly for 5 minutes, watching and listening FROM THE OPERATOR'S SEAT for binding or interfering parts.



**CAUTION:** Before investigating an unusual sound or attempting to correct a problem, shut off engine, engage park brake and remove key.

2. Check hay conditioner chain tension after 2 hours for proper tension. See Maintenance/Service section.

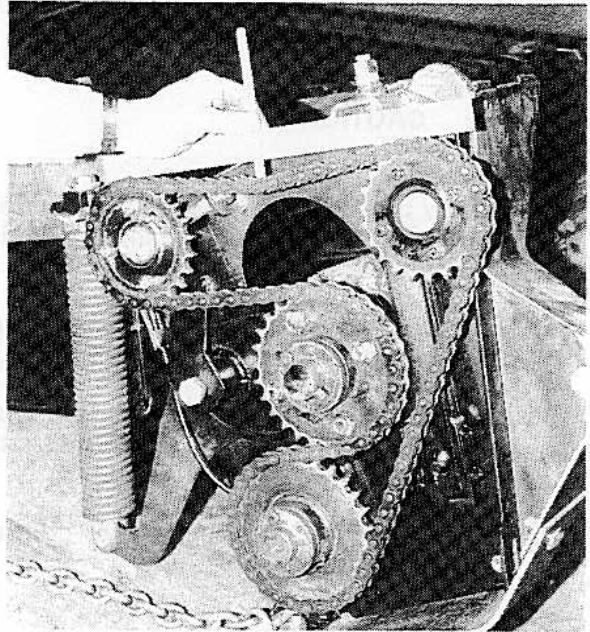

CHECK CONDITIONER CHAIN TENSION

3. Check all belts after 5 hours operation for initial stretch. Tighten as necessary. See Maintenance/Service section.

Continue to check belts periodically for the first 50 hours.

4. Check hardware after 5 hours operation. Tighten as necessary. See Specifications section for recommended torques.

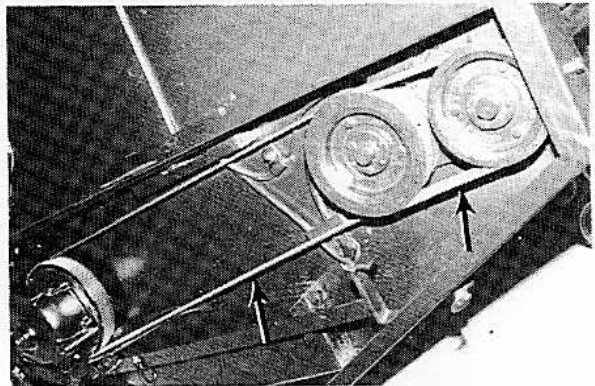

CHECK DRIVE BELT TENSION  
(DOUBLE SICKLE SHOWN)

5. Tighten the bottom and side wobble box mounting bolts (C) after 10 hours operation and every 100 hours thereafter. Torque to 200 ft.lbs. (270 N-m) starting with the side mounting bolts.

6. Change wobble box lubricant after 50 hours operation and every 1000 hours (or 3 years) thereafter. See Maintenance/Service section.

7. Until you become familiar with the sound and feel of your new header, be extra alert and attentive.

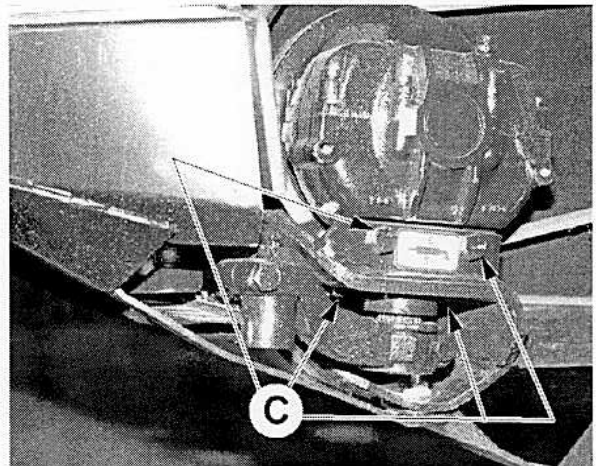

TIGHTEN WOBBLE BOX MOUNTING BOLTS

# OPERATION

## PRE-STARTING CHECKS

Do the following at the start of each operating season.



### CAUTION:

1. Review the Operator's Manuals to refresh your memory on safety and operating recommendations.
2. Review all safety signs and other decals on the machine and note hazard areas.
3. Be sure all shields and guards are properly installed and secured. Never alter or remove safety equipment.
4. Reacquaint yourself with the controls before beginning operation.

Also:

5. Adjust tension on all belts and chains. See Maintenance/Service section.
6. Perform all Annual Maintenance. See Maintenance/Service section.



# OPERATION

## PRE-STARTING CHECKS

Do the following each day before start-up:



### CAUTION:

1. Clear the area of other persons, pets etc. Keep children away from machinery. Walk around the header to be sure no one is under, on or close to it.
2. Remove foreign objects from the machine and surrounding area.
3. Wear close fitting clothing and protective shoes with slip resistant soles.

As well, carry with you any protective clothing and personal safety devices that **COULD** be necessary through the day. Don't take chances.

You may need:

- a hard hat
- protective glasses or goggles
- heavy gloves
- respirator or filter mask
- wet weather gear.

4. Protect against noise. Wear a suitable hearing protective device such as ear muffs or ear plugs to protect against objectionable or uncomfortably loud noises.
5. Check the machine for leaks or any parts that are missing, broken, or not working correctly.

**NOTE:** Use proper procedure when searching for pressurized fluid leaks. See "Hydraulic System" in Maintenance/Service section.

6. Clean all lights and reflectors on the header.
7. Perform all Daily maintenance. See Maintenance/Service section.

## OPERATE CORRECTLY

**IMPORTANT:** See Windrower Operator's Manual for information on the following:

- Start-Up Procedure
- Driving the Windrower
- Stopping Procedure

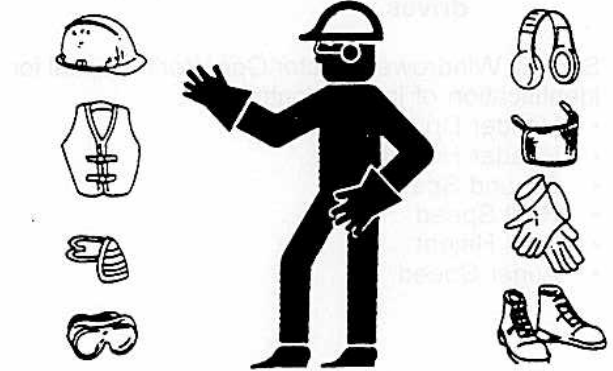

PROTECT YOURSELF



PROTECT AGAINST NOISE

# OPERATION

## HEADER CONTROLS



**CAUTION:** Be sure all bystanders are clear of machine before starting windrower or engaging any header drives.

See the Windrower Tractor Operator's Manual for identification of in-cab controls for:

- Header Drive Clutch
- Header Height
- Ground Speed
- Reel Speed
- Reel Height
- Auger Speed

## HEADER LIFT CYLINDER STOPS



**DANGER:** To avoid bodily injury or death from fall of raised header, always engage cylinder stops before going under header for any reason.

See the "9000 Series Windrower Tractor Operator's Manual" for instruction regarding the use and storage of header lift cylinder stops.

## REEL PROPS



**WARNING:** To avoid bodily injury from fall of raised reel, always engage reel props before going under raised reel for any reason.

Reel props are located at each reel support arm.

To engage reel props:

1. Raise reel to maximum height.
2. Move props (B) to engaged position.
3. Lower reel until props contact end frames.

**NOTE:** Keep pivot bolt (C) properly tightened so prop remains in stored position when not in use, yet can be engaged with hand force.

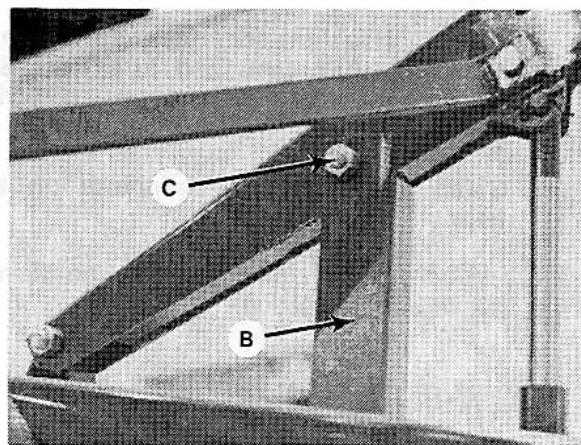

REEL PROP - ENGAGED

# OPERATION

## OPERATING VARIABLES

Satisfactory function of the header and hay conditioner in all situations requires making proper adjustments to suit various crops and conditions.

Correct operation reduces crop loss and allows cutting of more acres. As well, proper adjustments and timely maintenance will increase the length of service you receive from the machine.

The variables listed here and detailed on the following pages will affect the performance of the header and conditioner. You will quickly become adept at adjusting the machine to give you the desired results.

### MULTI-CROP HEADER

1. Cutting Height
2. Ground Speed
3. Reel Speed
4. Reel Height
5. Reel Fore-Aft Position
6. Reel Pick-Up Finger Pitch
7. Auger Speed
8. Header Angle
9. Header Flotation
10. Upper Cross Auger
11. Forming Rods

### HAY CONDITIONER

12. Roll Intermesh
13. Ground Clearance
14. Conditioner Float
15. Forming Shields

## OPERATING VARIABLES



# OPERATION

## CUTTING HEIGHT

See Windrower Tractor Operator's Manual for identification and instructions for use of header height control.

## **GRAIN CROPS**

For grain crops the windrow should normally be laid on stubble from 6 to 8 inches high (150 - 200 mm). Benefits of a stubble of this height:

- Allows free circulation of air under the windrow for more even drying.
- Supports the windrow without bending.
- Keeps grain heads from contacting ground. Heads that touch the ground are difficult to pick up and will sprout in damp weather.

**NOTE:** The windrower tractor has a "Cut Height Indicator" to help identify desired cut heights. See Tractor Operator's Manual for details.

## **HAY AND SPECIALTY CROPS**

### Skid Shoes

In hay and other specialty crops and conditions where it is desirable to cut close to the ground, use skid shoes to vary cutting height. The operator can then lower the header to the ground, allowing the shoes to provide a consistent cutting height.

**NOTE:** Lowering the skid shoes raises the cutting height. This may be desirable in stony conditions, to reduce damage to cutting components. Other benefits include reduced plugging due to mud or dirt build-up and longer stubble for faster drying.



**DANGER:** To avoid bodily injury or death from unexpected start-up or fall of raised header; stop engine, remove key and engage header lift cylinder stops before going under header to adjust skid shoes (or for any reason).

To adjust cutting height with skid shoes:

1. Loosen bolts (A), two per shoe, sufficiently to release rods (B) from supports (C).
2. Position shoe at the desired setting.
3. Adjust both shoes to the same position to provide an even cutting height.
4. Engage rods in supports, tighten bolts (A).

**NOTE:** Additional skid shoes may be installed if required.

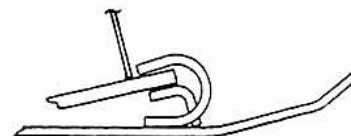
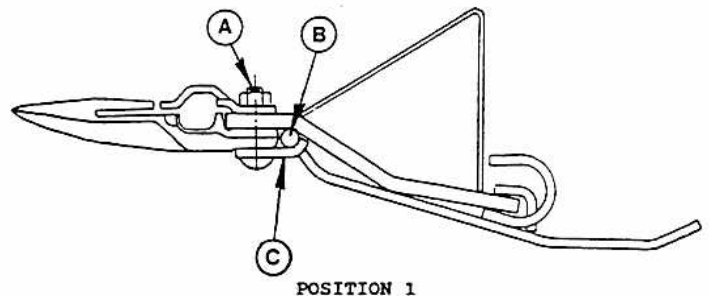

POSITION 2

SKID SHOE POSITIONS

# OPERATION

## GROUND SPEED

Ground speed of windrower should be such that sickle can cut crop smoothly and cleanly, while giving the desired windrow formation.

See Windrower Tractor Operator's Manual for identification and instructions for use of ground speed control.

As ground speed is increased, auger and reel speed should be increased to handle the extra material. The chart below indicates the relationship between ground speed and area cut for the three header sizes.

Example shown: At a ground speed of 6 miles per hour (9.7 km/h) with a 15 ft. header, the area cut per hour would be approximately 11 acres (4-1/2 hectares).

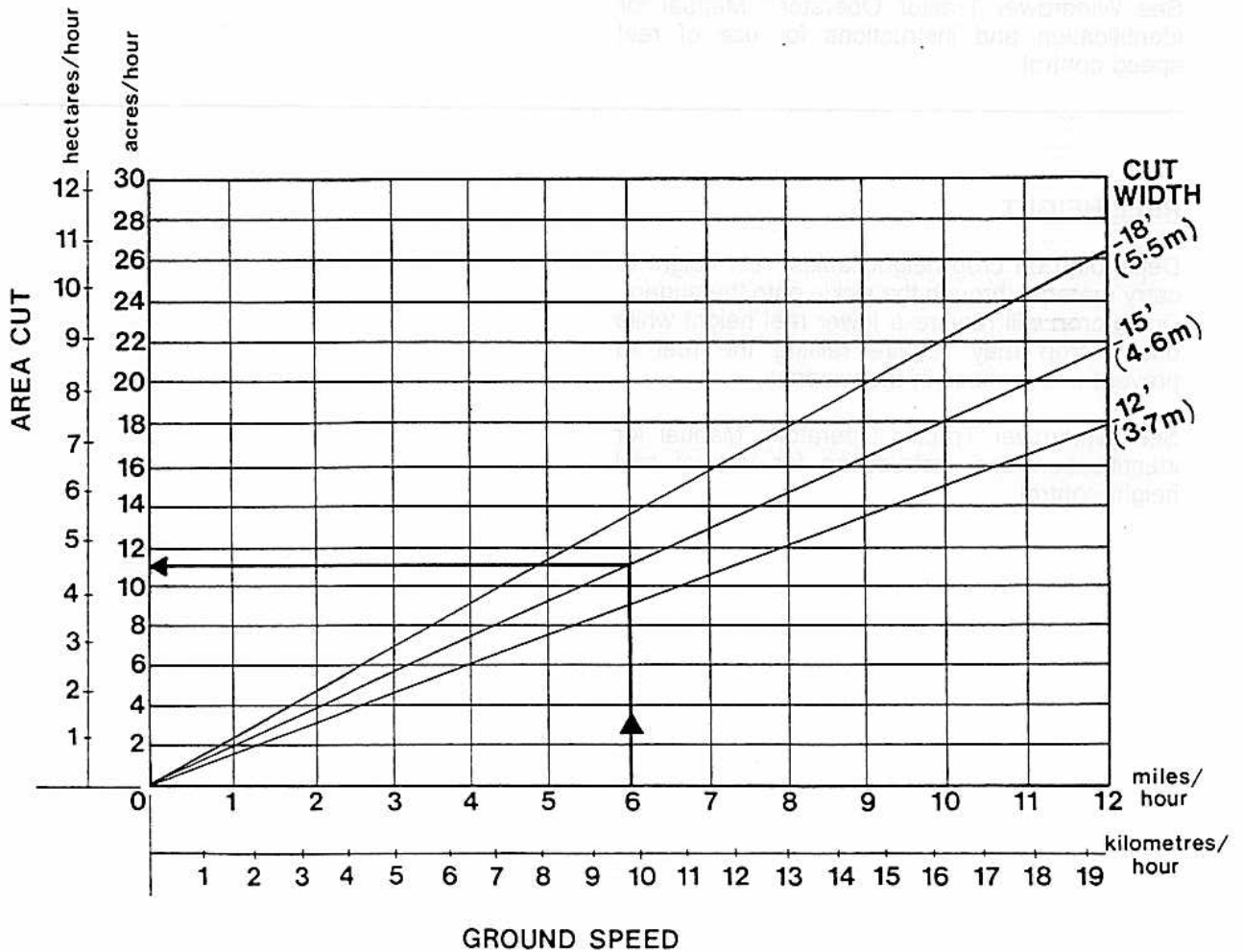

# OPERATION

## REEL SPEED

Reel speed affects feeding of crop into the sickle and augers, as well as the smoothness and evenness of the windrow. Operating the reel too fast or too slow relative to ground speed will cause bunching in the windrow.

In standing crop, reel speed should be just faster than ground speed. This gently sweeps crop across sickle onto the augers.

The more "down" the crop, the faster the reel speed should be in relation to ground speed. This can be achieved by increasing reel speed, decreasing ground speed, or both.

Excessive shattering of grain heads may be an indication that reel speed is too fast. Excessive reel speed causes undue wear of reel components and unnecessary load on reel drive, resulting in uneven reel motion.

See Windrower Tractor Operator's Manual for identification and instructions for use of reel speed control.

---

## REEL HEIGHT

Depending on crop height, adjust reel height to carry material through the sickle onto the augers. Down crop will require a lower reel height while bushy crop may require raising the reel to prevent unevenness in the windrow.

See Windrower Tractor Operator's Manual for identification and instructions for use of reel height control.



# OPERATION

## REEL POSITION - FORE & AFT

Reel fore-aft position can be adjusted to suit various crop conditions:

- For straight standing crop, the reel position is normally centered above the cutterbar. The eighth hole from the front of the support arms is a good starting point.
- For crops that are down, tangled or leaning, move reel ahead of cutterbar\*. This allows raising cutterbar to clear dead material or rocks and lowering the reel to pick up the down material while maintaining finger to sickle clearance.
- \* **IMPORTANT:** To prevent damage from contact with divider rods, do not operate reel forward of the sixth hole position.
- Bushy crops require positioning the reel behind the cutterbar, applying downward force on the crop.

### To adjust reel fore-aft position:

1. Lower reel so support arms are approximately horizontal.
2. Back off jam nut on positioning screw (A), both ends.
3. Loosen screw (A) and slide reel mounting channel (B). A pry bar may be used at hole (C).
4. Tighten screw into selected hole position and secure with jam nut.
5. Be sure positioning screw is in the same hole at both ends.
6. Check reel clearance to cutterbar. Minimum finger to guard clearance is 3/8 in. (10 mm). See Maintenance/Service section for adjustment procedure.
7. Check reel clearance to augers. Fingers should come as close to augers as possible, without contact.

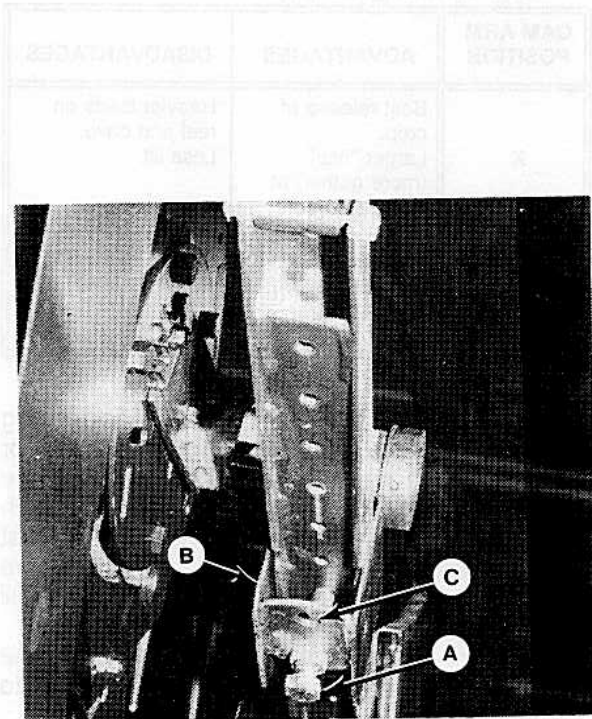

REEL FORE-AFT POSITION ADJUSTMENT

ADJUSTMENT	ADJUSTMENT	ADJUSTMENT	ADJUSTMENT	ADJUSTMENT

# OPERATION

## PICK-UP REEL ADJUSTMENTS

The MacDon Pick-Up Reel supplied with this header has a series of adjustments which affect crop flow into the sickle and augers. This section describes these adjustments and gives recommended settings for several crops and conditions. The Trouble Shooting section of this manual includes some tips to improve performance.

**Finger Pitch** is the angle the fingers operate at in relation to the ground. In the illustration below, finger pitch on right is more aggressive than pitch on left. Generally, a more aggressive finger pitch is required for crops that are down, tangled or matted. A less aggressive finger pitch is suitable for standing crop.

Adjustment of the finger pitch is achieved in two stages:

1. Select Cam Arm Position - This is a major adjustment made by moving cam arm mounting bolt to position X or position Y as shown. All cam arms at both ends of the reel must be in the same position. Position X is a less aggressive setting, recommended for standing or partially down crops. Position Y is a more aggressive setting, recommended for down and tangled crops.

CAM ARM POSITION	ADVANTAGES	DISADVANTAGES
X	Best release of crop. Larger "bite" (more gather) at crop entry.	Heavier loads on reel and drive. Less lift.
Y	Lighter loads on reel and drive. Better lifting action.	At high RPM, may cause "tossing" of plants in short, light crops.

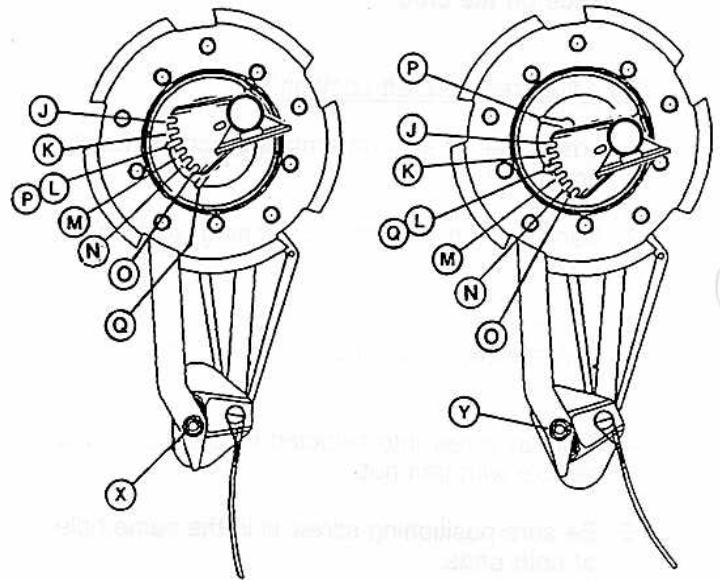

FINGER PITCH ADJUSTMENTS

2. Select Finger Pitch - This is a fine-tuning adjustment made by selecting range slot P or Q and pitch notch J, K, L, M, N or O. Range slot P is more aggressive than slot Q. Pitch notch J is least aggressive, notch O is most aggressive. Select a position aggressive enough to provide sufficient lift, yet still release crop properly.

**TIP:** In bushy crop that sits high on the augers, try a more aggressive finger pitch to reduce carry-over.

## RECOMMENDED SETTINGS

CROP CONDITIONS	CROP TYPE	CAM ARM POSITION	RANGE SLOT	FINGER PITCH NOTCH
Standing or Partially Down	Alfalfa, Short Cereal	X	P	L or M
Thick, Heavily Matted, Mostly Down	Canola, Peas	Y	Q	M
		Y	P	J
	Tall Cereal	Y	P	K or L

**NOTE:** Recommended finger pitch notches are for MacDon 942 Multi-Crop Header. This will vary for other headers.



## OPERATION

### PICK-UP REEL CAM ARM POSITION AND FINGER PITCH ADJUSTMENT PROCEDURES

**IMPORTANT:** To avoid reel damage, be sure the same notch and range slot are being used at both ends of the reel. Be sure crank position is consistent at all cam arms at both ends.

#### To adjust cam arm position:

1. Lower the reel or engage reel support arm props.
2. Lower header fully.
3. Reposition cam arm bolt from position (X) to position (Y) or vice versa.
4. Repeat at all cam arms, both sides.
5. Tighten cam arm bolts to 170 ft.lbs. (230 N·m).

#### To adjust finger pitch angle:

1. Lower the reel and header fully.
2. Loosen carriage bolts (S) and (T) on both L/H and R/H cam assemblies.
3. Slide the front carriage bolt (S) out of the notch at each end. (To change to alternate range slot (Q), remove loosened bolt and nut from keyhole slot.)
4. Adjust to desired position as follows:  
Grasping one bat to keep it from rotating relative to the reel, rotate reel by hand to move cam to desired position. If cam remains stationary, use a 3/8 drive ratchet handle (V) in alternate range slot (Q) to rotate the cam. Slide carriage bolt into new notch and tighten bolts (S) and (T) to 22 ft.lbs. (30 N·m).
5. Check clearance to cutterbar and augers:  
When operating reel with an aggressive finger pitch, be sure that fingers will not contact sickle when flexed back by crop, as at (R). Minimum finger path to guard clearance is 3/4" (20 mm). Finger path should come as close to augers as possible, without contact. See "Reel Clearance to Cutterbar" in Maintenance/Service section.

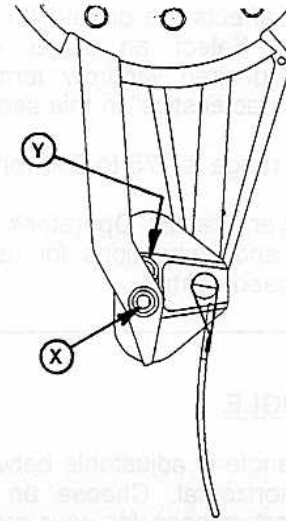

CAM ARM POSITION ADJUSTMENT

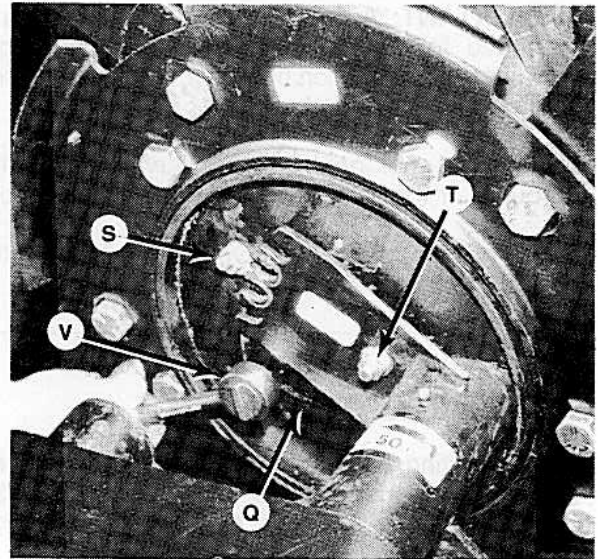

FINGER PITCH ADJUSTMENT

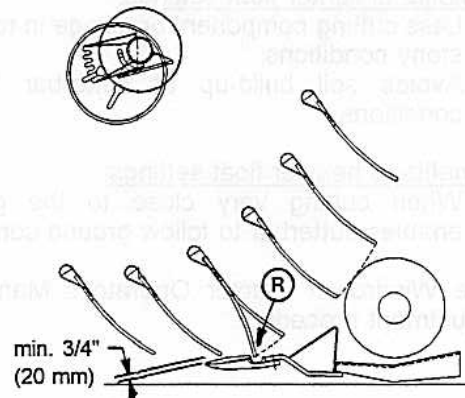

CHECK CLEARANCE TO SICKLE AND AUGERS

# OPERATION

## AUGER SPEED

Auger speed affects the orientation of stalks in the windrow. Select an auger speed that provides the desired windrow formation. See "Windrow Characteristics" in this section.

Auger speed range is 175 to 500 rpm.

See Windrower Tractor Operator's Manual for identification and instructions for use of auger (conveyor) speed control.

---

## HEADER ANGLE

The header angle is adjustable between 6° and 13° below horizontal. Choose an angle that maximizes performance for your crop and field conditions.

**IMPORTANT:** A flatter header angle is recommended for normal conditions. A flatter angle reduces sickle section breakage and reduces soil build-up at the cutterbar in wet conditions.

Use a steeper angle to cut very close to the ground, or for better lifting action of down crops.

See Windrower Tractor Operator's Manual for adjustment procedure.

---

## HEADER FLOTATION

As a starting point for normal conditions, adjust float spring tension so 75 to 100 lbs. force (335 to 445 N) is required to lift cutterbar off ground at each end.

Your specific requirements and conditions may require heavier or lighter float.

### Benefits of lighter float settings:

1. Less cutting component breakage in rough or stony conditions.
2. Avoids soil build-up at cutterbar in wet conditions.

### Benefits of heavier float settings:

1. When cutting very close to the ground, enables cutterbar to follow ground contours.

See Windrower Tractor Operator's Manual for adjustment procedure.

---

## OPERATION

### UPPER CROSS AUGER (Optional)

For tall or bulky crops, the optional upper cross auger (D) will aid crop flow across the header and through the delivery opening.

The position of the upper cross auger is adjustable for best feeding of the crop. A suggested setting is 4 inches (100 mm) from cross auger flighting to rear deck for normal conditions. Extremely tall crops will require a higher setting.

To adjust:

1. Lower reel fully.  
**IMPORTANT:** To avoid machine damage caused by contact of reel and cross auger, always position the cross auger with the reel fully lowered. This prevents positioning the auger too high.
2. Loosen auger mounting clamp bolt (F) at both ends of header.



**CAUTION:** Be aware of a pinch point at (J) between cross auger end shield and reel brace as auger is raised.

3. Rotate the auger around the frame tube to desired location.
4. Tighten clamp bolts (F) to secure the position.

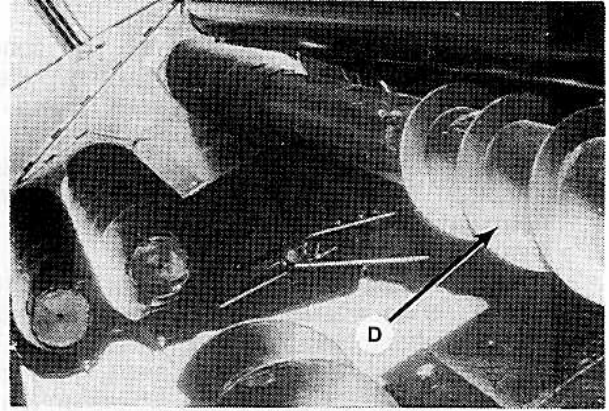

UPPER CROSS AUGER

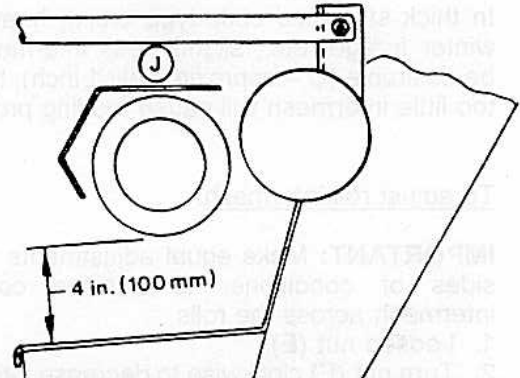

CROSS AUGER POSITION - NORMAL COND.

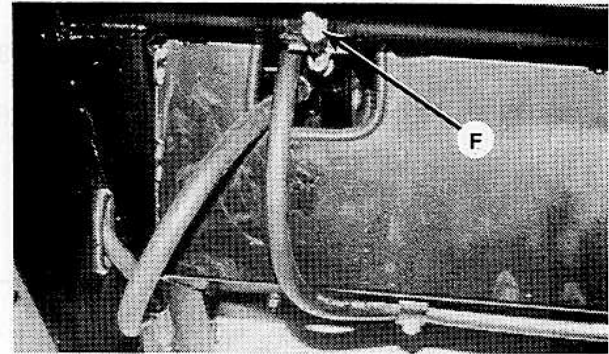

CLAMP BOLT - BOTH SIDES

### FORMING RODS (Optional)

Bend forming rods (C) as required to assist formation of desired windrow when hay conditioner is not installed.

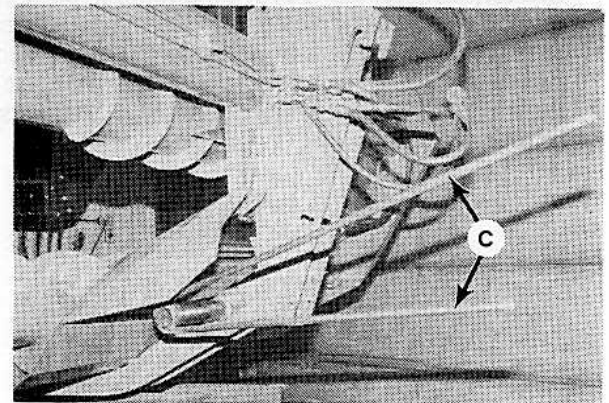

FORMING RODS

## OPERATION

### HAY CONDITIONER ROLL INTERMESH

The intermeshing steel rolls of the hay conditioner crimp the plant stems in several places, allowing moisture release and quicker drying.

The degree to which the stems are conditioned (crimped) depends on the amount of roll intermesh and roll spring tension (see below).

Correct conditioning of alfalfa, clover and other legumes is usually indicated when 90% of the stems show crimping but no more than 5% of the leaves are damaged. To achieve this, roll intermesh is factory set so that dimension (D) is 5/8 inch (16 mm) for normal operation.

In thick stemmed cane-type crops, heavy oats, winter forage, etc., slightly less intermesh may be desirable (D = approximately 1 inch); however too little intermesh will cause feeding problems.

#### To adjust roll intermesh:

**IMPORTANT:** Make equal adjustments on both sides of conditioner to achieve consistent intermesh across the rolls.

1. Loosen nut (E).
2. Turn nut (F) clockwise to decrease intermesh, or counter-clockwise to increase intermesh.

**NOTE:** Nut (F) is welded to adjuster tube, so complete assembly will turn.

3. Check intermesh with a 3/4 inch nut. (A 3/4 inch nut is 5/8 inch (16 mm) high.)
4. When intermesh is correct, tighten nut (E) while holding nut (F) with another wrench to lock the position securely.

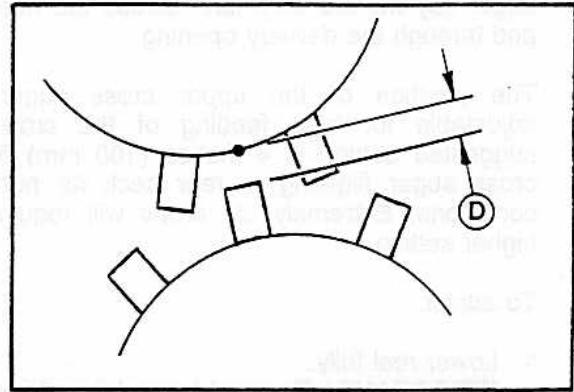

**ROLL INTERMESH**  
(Maintain 5/8" (16 mm) bar-to-roll gap)

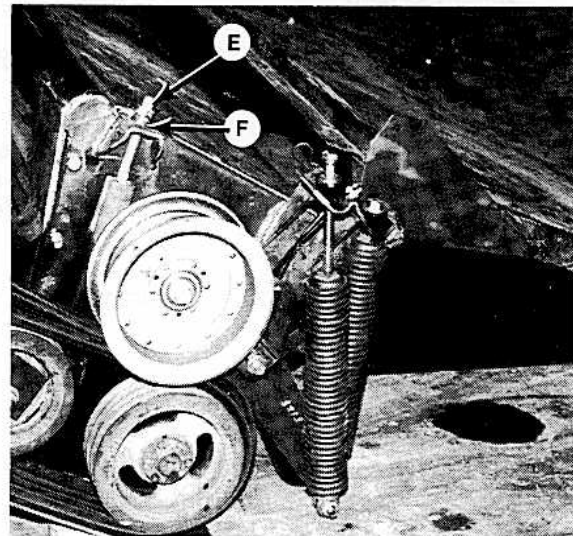

**ROLL INTERMESH ADJUSTMENT**

### HAY CONDITIONER ROLL TENSION SPRINGS

The conditioner roll intermesh is maintained by two tension springs to provide adequate pressure for correct conditioning of the crop. These springs also allow the rolls to open to allow passage of small solid objects without damage to the rolls. The roll tension has been factory set and is not adjustable.



## OPERATION

### HAY CONDITIONER GROUND CLEARANCE

The conditioner body can be raised or lowered to suit crop and field conditions. Too high a setting will not allow the rolls to pick up all of the crop, while too low a setting in stony conditions can damage the bottom roll.

#### To adjust ground clearance:

1. Raise header fully. Stop engine, remove key and engage header lift cylinder stops.
2. Place a 3 to 4 inch block (75 to 100 mm) under the R/H conditioner shoe as shown at (G). (No block under left side.)
3. Remove header lift cylinder stops and lower conditioner onto block. Shut off engine and remove key.
4. Move R/H chain to desired position in bracket by inserting head of bolt (H) into keyhole slot.
5. Raise header fully. Stop engine, remove key and engage header lift cylinder stops. Remove block from under R/H conditioner shoe.
6. Remove header lift cylinder stops, lower header to cutting height and check conditioner float (see following page).

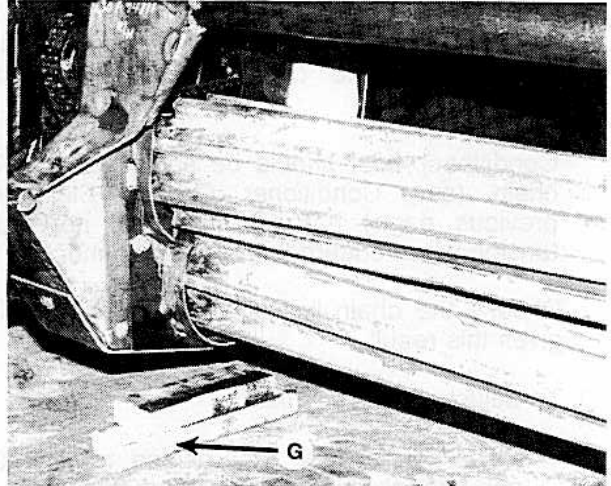

BLOCK R/H SIDE TO SLACKEN CHAIN

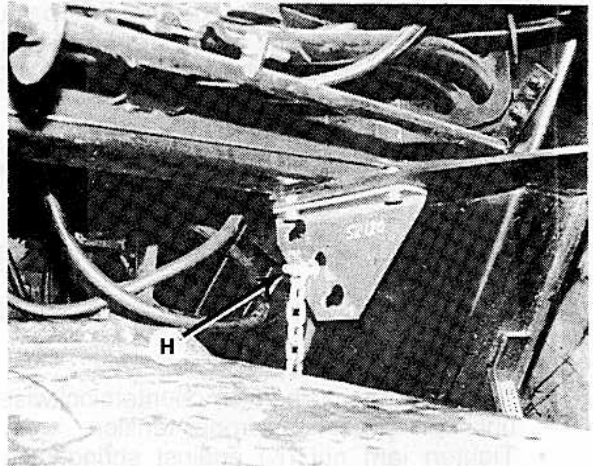

MOVE R/H CHAIN TO DESIRED POSITION

## OPERATION

### HAY CONDITIONER FLOAT

The conditioner float is controlled by the spring at the L/H side connected to the tractor floorboard.

Conditioner float should be such that the R/H chain (see Conditioner Ground Clearance, previous page) has no slack but not much tension when cutterbar is on the ground.

Choose the chain link at the L/H spring which gives this result.

To adjust conditioner float:

1. Raise header fully. Stop engine, remove key and engage header lift cylinder stops.

2. Remove pin (J) and connect chain at desired link.

**NOTE:** If R/H chain is too loose (too much float) move to a link further from the spring. If R/H chain is too tight (too little float), move to a link closer to the spring.

3. Remove header lift cylinder stops and lower header to ground. Repeat if necessary.

4. If R/H chain is still loose when L/H chain is at the last link:

- Raise header fully. Stop engine and remove key.
- Loosen jam nut (K).
- Turn float spring bolt (L) counterclockwise until R/H chain is at proper tension.
- Tighten jam nut (K) against spring plug to secure the position.

**NOTE:** Check conditioner float whenever substantial changes are made to the length of the center link between tractor and header.

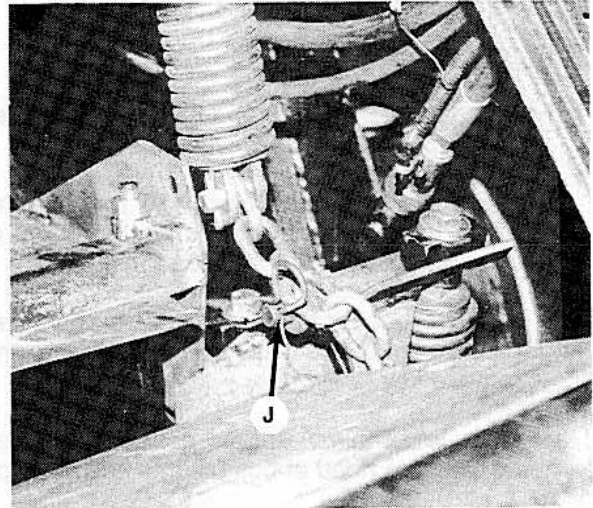

CONDITIONER FLOAT ADJUSTMENT

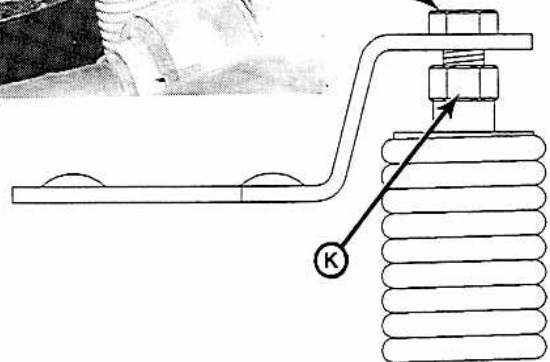
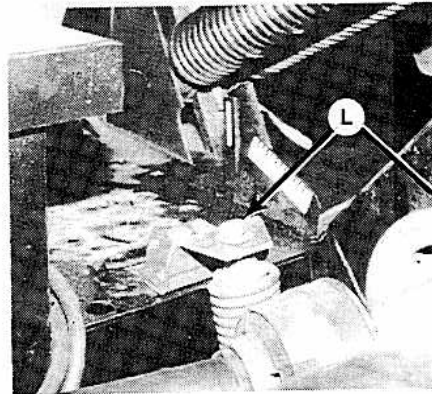

CONDITIONER FLOAT SPRING  
BOLT ADJUSTMENT

# OPERATION

## HAY CONDITIONER FORMING SHIELDS



**CAUTION:** Keep forming shields installed at all times conditioner is in use. Do not allow anyone to stand behind the machine while operating. Stones or other foreign objects may be ejected from the conditioner with force.

The side and rear deflectors are adjustable to shape the windrow to your preference.

In deciding on windrow width, the following factors should be considered:

- weather conditions (rain, sun, humidity, wind)
- type and yield of crop
- drying time available
- method of processing (bales, silage, "green-feed")

A wider windrow will generally dry faster and more evenly, resulting in less protein loss. Fast drying is especially important in areas where the weather allows only a few days to cut and bale. See "Haying Tips" in this section for more information.

Where weather conditions permit or when drying is not critical, for example, when cutting for silage or "green-feed", a narrower windrow may be preferred for ease of pick-up.

### Windrow Width

Move the side deflectors (H) to the desired width. There is no hardware to be loosened.

**NOTE:** If side deflectors are too loose or too difficult to move; adjust torque of nut (J) to 100 ft.lbs. (135 N·m). Then, holding nut (J) with a wrench, tighten nut (K) securely against nut (J).

### Deflector Fins

The four standard deflector fins (D) may be positioned to spread crop evenly across wide windrows. Set the two left side fins approximately parallel to L/H side deflector (H) and the two right side fins approximately parallel to R/H side deflector. Adjust for best distribution of crop. To avoid bunching, do not use fins for narrow windrows. For the widest windrows, four additional deflectors may be mounted in holes provided.

### Rear Deflector

The rear deflector (L) slows the crop exiting the conditioner rolls, directs the flow downward, and "fluffs" the material.

The rear deflector can be adjusted down for more crop control in light material, and up for clearance in heavier crops.

To adjust rear deflector, loosen bolts (M), one per side, position deflector and tighten bolts (M). For even windrow formation, be sure deflector is not twisted.

### Forming Shield Height

Depending on the amount of crop material, the rear of the forming shield assembly can be raised or lowered to properly deflect the crop. Too high a setting does not allow the deflectors to shape the windrow, while too low a setting will cause uneven and poorly formed windrows.

To adjust forming shield rear height, remove hairpin (N), both sides, and raise or lower shields to desired height.

**NOTE:** For normal operation, front of forming shield assembly is attached to conditioner at (P). If a lower position is desired, (eg. with Ford 9030 Tractor) attach at hole (R). See Assembly section for details.

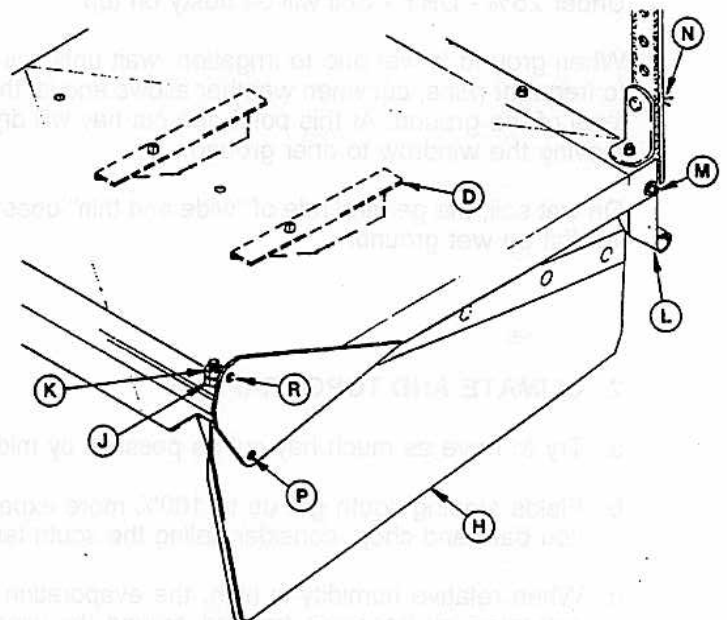

HAY CONDITIONER FORMING SHIELDS

# OPERATION

## HAYING TIPS

The following information may be useful when using the header in hay crops:

There is one certainty when making hay - a fast cure will maintain top quality. It is critical to have the cured hay baled as quickly as possible, for two reasons:

1. Every day hay lies on the ground, 5% of the protein is lost.
2. The sooner the cut hay is off, the earlier the start for next growth.

Generally, leaving the windrow as wide and thin as possible makes for the quickest curing, however there are other factors which affect curing time:

### 1. TOPSOIL MOISTURE

When the ground is wetter than the hay, moisture from the soil is absorbed by the hay above it. Determine topsoil moisture level before cutting. Use a moisture tester or estimate level:

Over 45% - WET - Soil will be muddy  
25 - 45% - DAMP - Walking on soil leaves tracks  
Under 25% - DRY - Soil will be dusty on top

When ground is wet due to irrigation, wait until soil moisture drops below 45%. When ground is wet due to frequent rains, cut when weather allows and let the forage lie on wet ground until it dries to the moisture level of the ground. At this point, the cut hay will dry no more until the ground under it dries, so consider moving the windrow to drier ground.

On wet soil, the general rule of "wide and thin" does not apply. A narrower windrow will dry faster than hay left flat on wet ground.

### 2. CLIMATE AND TOPOGRAPHY

- a. Try to have as much hay cut as possible by midday, when drying conditions are best.
- b. Fields sloping south get up to 100% more exposure to the sun's heat than do north sloping fields. If you bale and chop, consider baling the south facing fields and chopping those facing north.
- c. When relative humidity is high, the evaporation rate is low and hay dries slower. If there is no wind, saturated air becomes trapped around the windrow, further hindering the drying process. Raking or tedding will expose the hay to fresher, less saturated air. Cutting hay perpendicular to the direction of the prevailing winds may also help.



# OPERATION

## HAYING TIPS (continued)

### 3. WINDROW CHARACTERISTICS

See "Operating Variables" in this section. Control the factors listed to produce a windrow with the following characteristics:

- a. High and fluffy for good air flow. The movement of air through the windrow is more important to the curing process than direct sunlight.
- b. Consistent formation, not bunchy. A uniform windrow permits an even flow of material into the baler, chopper etc.
- c. Even distribution, not piled in the middle or higher on one side. A windrow that is higher or heavier on one side could cause stacks to lean, round bales to have one end smaller and loose, or small square bales to be heavy on one side, causing handling and stacking problems.
- d. Properly conditioned without excessive leaf damage.

### 4. RAKING AND TEDDING

Raking or tedding will speed up drying, however the benefits must be weighted against the additional leaf losses which will result. When the ground beneath the down hay is dry, raking or tedding is probably not worthwhile.

Big windrows on damp or wet ground should be turned over when they reach 40-50% moisture. Hay should not be raked or tugged at less than 25% moisture, or excessive yield losses will result.

### 5. CHEMICAL DRYING AGENTS

Hay drying agents work by removing wax from legume surfaces, enabling water to escape and evaporate faster. However, treated hay lying on wet ground will also absorb ground moisture faster.

Before deciding to use a drying agent, costs and benefits relative to your area should be carefully compared.

---

### GRAIN WINDROW CHARACTERISTICS

Factors such as ground speed, reel speed, auger speed and cutting height will all affect the resulting windrow. You will quickly become adept at adjusting these variables to achieve the desired results.

**NOTE:** Crop condition is a major factor in forming a good windrow. While standing or uniformly leaning crops can generally be easily formed into an acceptable windrow, such is not the case when stalks are tangled or leaning in several directions.

There are three basic criteria to look for in a quality windrow:

1. Weight Distribution - heads and stalks distributed evenly across full width of windrow.
2. Good Curing - a loose, open windrow for better drying.
3. Good Weatherability - a well formed windrow that holds heads off ground and holds together in extreme weather conditions.

# OPERATION

## UNPLUGGING THE HEADER



**WARNING:** Stop engine and remove key from ignition before removing plugged material from header.

If the sickle plugs:

1. Stop forward movement of the windrower and disengage header drive clutch.
2. With header on ground, back up several feet and engage header drive clutch.
3. If plug does not clear, disengage header drive clutch and raise header fully.
4. Shut off engine, remove key and engage park brake.
5. Engage header lift cylinder stops.



**WARNING:** Wear heavy gloves when working around sickle.

6. Clean off cutterbar.

If sickle plugging persists, see Trouble Shooting section.

If conditioner rolls plug:

1. Stop forward movement of the windrower, disengage header drive clutch and raise header and reel fully.
2. Shut off engine, remove key and engage park brake.
3. Engage header lift cylinder stops and reel props.



**WARNING:** Wear heavy gloves when working around sickle.

4. Clean off cutterbar and area under reel.
5. Standing in delivery opening, engage wrench (A) on conditioner lower roll and push down to reverse conditioner rolls to loosen a wad of crop material or foreign object.
6. Remove wad or foreign object.
7. Store wrench at left end of header, securing with hair pin at (C) as shown.

If plugging persists, see Trouble Shooting section.

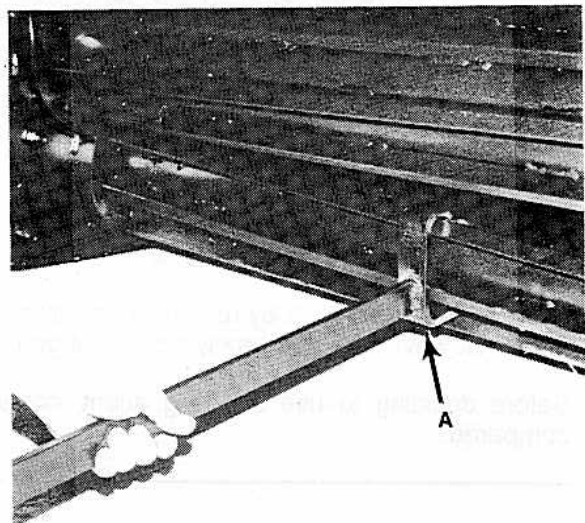

CLEARING PLUGGED CONDITIONER ROLLS

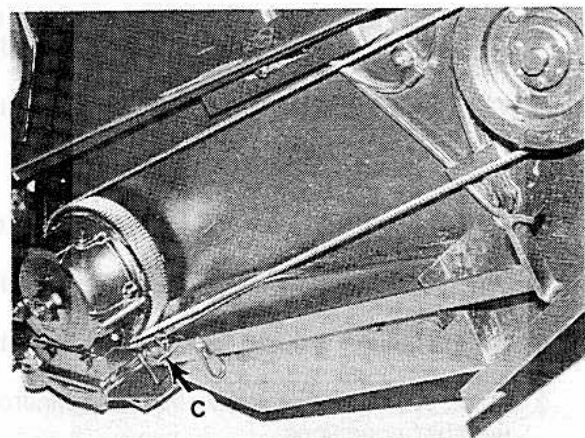

WRENCH STORAGE

# OPERATION

## TRANSPORTING THE HEADER

See "Transporting the Windrower" in Windrower Tractor Operator's Manual for recommended procedures for:

- Driving the Windrower On Roads
- Towing the Windrower on a Trailer
- Towing the Windrower without a Trailer

---

## LIFTING HEADER IN WORKING POSITION

If it is necessary to lift header once it has been lowered from shipping position to working position, see "Lifting Vehicle Requirements" and "Chain Requirements" in Unloading & Assembly section before proceeding.

Attach one chain (C) from lifting vehicle to both end panels at cutterbar. Attach a second chain (D) from lifting vehicle to center link anchor on frame tube as shown.



**CAUTION:** Be sure hooks are secure before lifting header. Stand clear when lifting, as machine may swing.

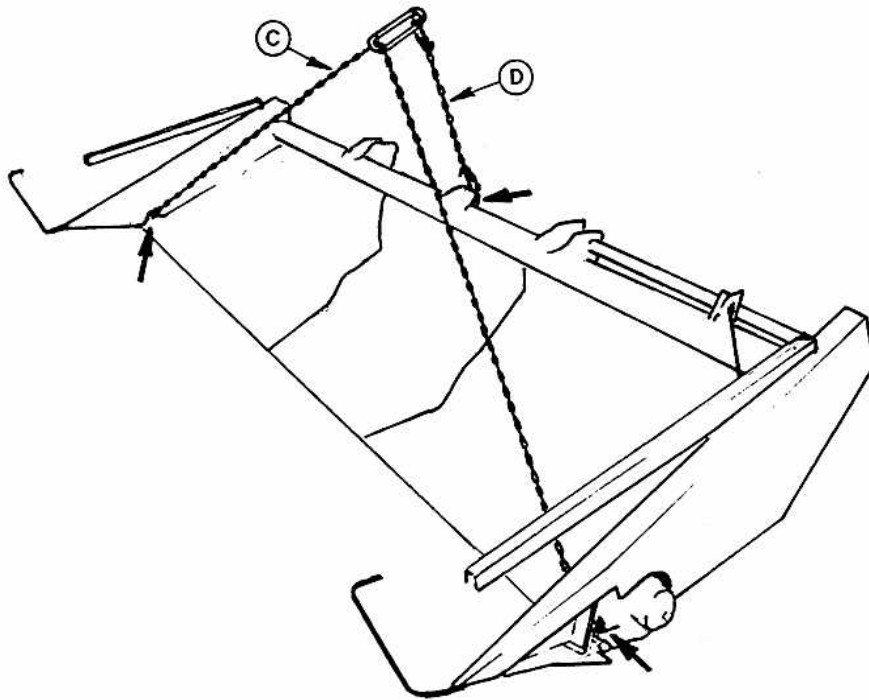

LIFTING HEADER IN WORKING POSITION

# OPERATION

## STORAGE PROCEDURE

Do the following at the end of each operating season:



**CAUTION: 1. Clean the windrower thoroughly. Never use gasoline, naphtha or any volatile material for cleaning purposes. These materials may be toxic and/or flammable.**

**2. Store machine in a dry, protected place if possible.**

**3. Cover cutterbar and sickle guards to prevent injury from accidental contact.**

Also:

4. Repaint all worn or chipped painted surfaces to prevent rust.
5. Loosen all drive belts.
6. Lubricate the windrower thoroughly, leaving excess grease on fittings to keep moisture out of bearing. Apply grease to exposed threads and sliding surfaces of components.
7. Pick-Up Reel: Oil all plastic bearings at reel bats to prevent rusting of shafts.
8. Check for worn or broken components and repair or order replacements from your dealer. Attention to these items right away will save time and effort at beginning of next season.
9. Tighten loose hardware and replace any missing hardware. See Specification section for torque charts.

# MAINTENANCE/SERVICE

## SERVICE PROCEDURES



**CAUTION:** To avoid personal injury, before servicing machine or opening drive covers:

1. Fully lower header and reel. If necessary to service in the raised position, first engage header lift cylinder stops and reel props.
2. Disengage header drive clutch.
3. Stop engine and remove key.
4. Engage park brake.
5. Wait for all moving parts to stop.

Wear close-fitting clothing and cover long hair. Never wear dangling items such as scarves or bracelets.

Wear protective shoes with slip-resistant soles, a hard hat, protective glasses or goggles and heavy gloves.

Be prepared if an accident should occur. Know where the first aid kit and fire extinguishers are located and how to use them.

Keep the service area clean and dry. Wet or oily floors are slippery. Wet spots can be dangerous when working with electrical equipment. Be sure all electrical outlets and tools are properly grounded.

Use adequate light for the job at hand.

Replace all shields removed or opened for service.

Use only service and repair parts made or approved by the equipment manufacturer. Substituted parts may not meet strength, design or safety requirements.

Keep the machine clean. Never use gasoline, naphtha or any volatile material for cleaning purposes. These materials may be toxic and/or flammable.



# MAINTENANCE/SERVICE

## RECOMMENDED LUBRICANTS

### GREASE

Use an SAE Multi-Purpose High Temperature Grease with Extreme Pressure (EP) Performance and containing at least 1.5% molybdenum disulphide.

Also acceptable is an SAE Multi-Purpose Lithium Base Grease.

### WOBBLE BOX LUBRICANT

In sickle drive wobble box, use SAE 85W-140 gear lubricant. (API Service Classification GL-5)

### CAPACITIES

Wobble Box – 2.2 litres (2.3 U.S. quarts)

### STORING LUBRICANTS

Your machine can operate at top efficiency only if clean lubricants are used. Use clean containers to handle all lubricants. Store them in an area protected from dust, moisture and other contaminants.

---

## SEALED BEARING INSTALLATION

1. Clean shaft and coat with rust preventative.
2. Install flangette, bearing, flangette and lock collar. The locking cam is only on one side of the bearing.
3. Install (but do not tighten) the flangette bolts.
4. When the shaft is located correctly, lock the lock collar with a punch. The collar should be locked in the same direction the shaft rotates. Tighten the set screw in the collar.
5. Tighten the flangette bolts.
6. Loosen the flangette bolts on the mating bearing one turn and re-tighten. This will allow the bearing to line up.

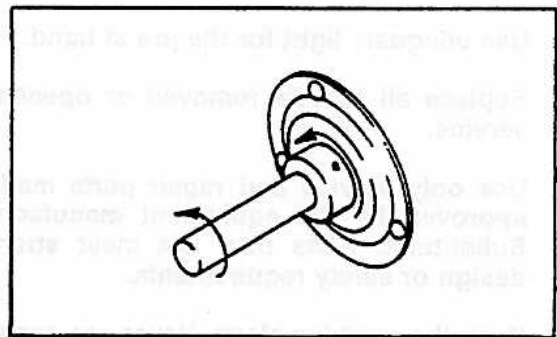

TIGHTEN COLLAR IN DIRECTION  
SHAFT ROTATES

## MAINTENANCE/SERVICE

### GREASING THE HEADER AND CONDITIONER

See "Recommended Lubricants" in this section for recommended greases.

The following greasing points are marked on the header by decals showing a grease gun (A), and grease interval (B) in hours of operation. Use the hour meter in the windrower cab and the "Maintenance Checklist" provided to keep a record of scheduled maintenance.

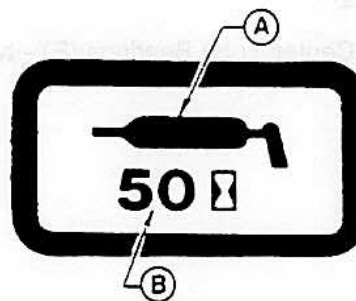

SAMPLE GREASE DECAL

#### **Procedure:**

1. Wipe grease fitting with a clean cloth before greasing, to avoid injecting dirt and grit.
2. Inject grease through fitting with grease gun until grease overflows fitting, except where noted. Inject grease slowly to prevent seal damage.
3. Leave excess grease on fitting to keep out dirt.
4. Replace any loose or broken fittings immediately.
5. If fitting will not take grease, remove and clean thoroughly. Also clean lubricant passageway. Replace fitting if necessary.

#### **25 Hours:**

1. Sickle Head (E) - single sickle: one fitting  
- double sickle: two fittings

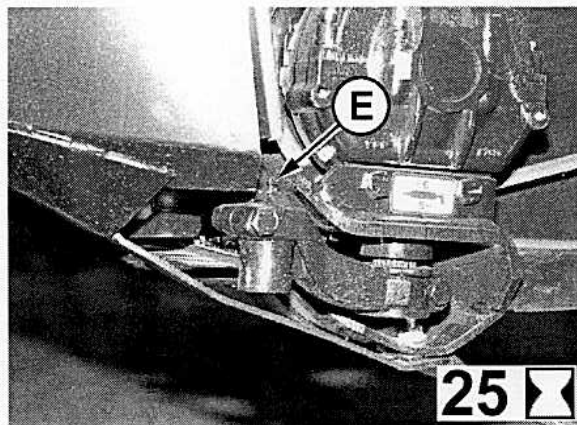

SICKLE HEAD

2. Cross-Shaft Support Tube (D)  
- two fittings on Double Sickle Header

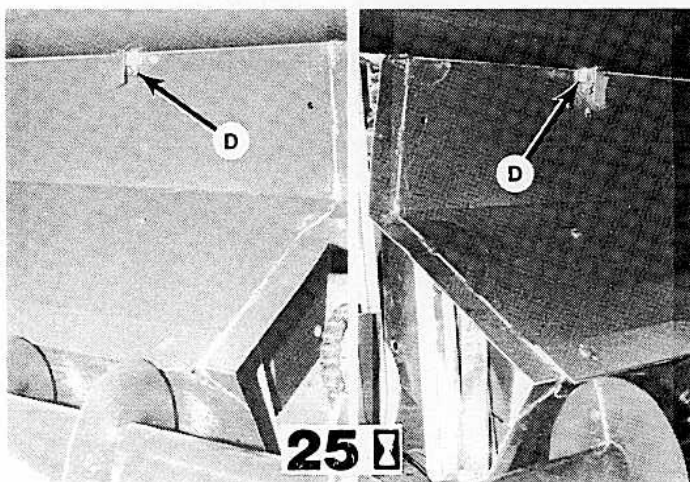

CROSS-SHAFT SUPPORT TUBE  
DOUBLE SICKLE HEADER

## MAINTENANCE/SERVICE

### GREASING THE HEADER AND CONDITIONER (continued)

#### **50 Hours:**

1. Reel Center Tube Bearings (E) - two fittings

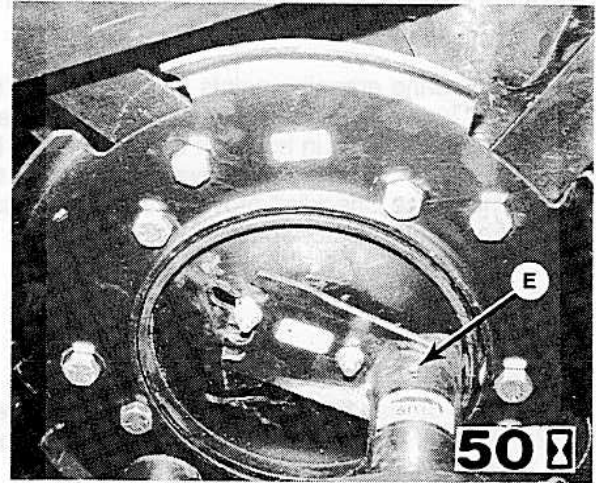

REEL CENTER TUBE BEARINGS

2. Hay Conditioner Roll Bearings (F) - four remote fittings (two per side)

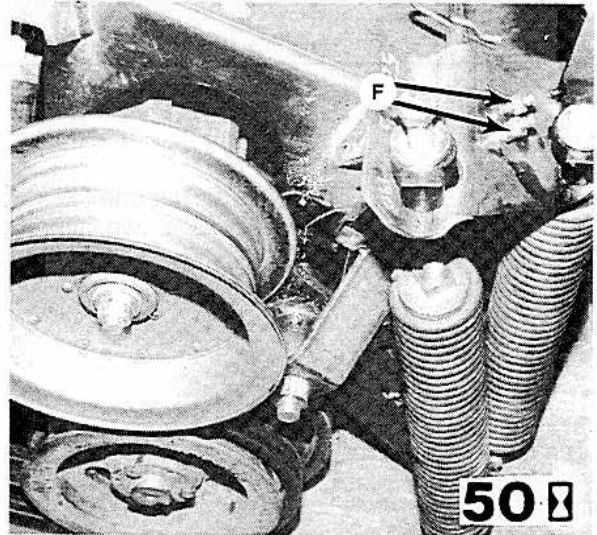

HAY CONDITIONER ROLL BEARINGS  
(BOTH SIDES)

3. Hay Conditioner Belt Idler Pulley Bearings (H) - one fitting

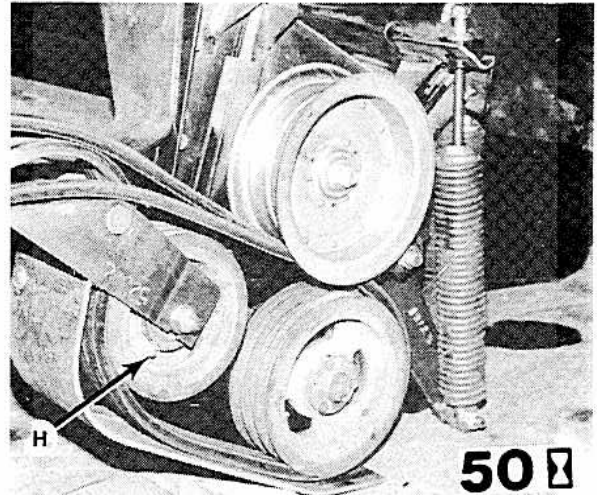

HAY COND. IDLER PULLEY BEARINGS

## MAINTENANCE/SERVICE

### 100 Hours or Annually

1. Sickle Drive Shaft Support Bearings (J) & (K)  
- two fittings.

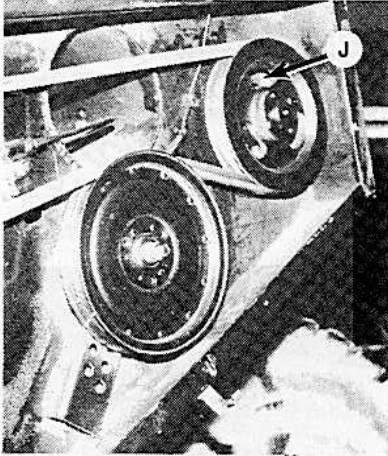

LEFT END (SINGLE SICKLE)

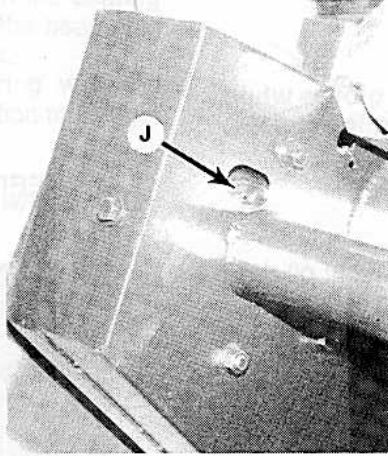

LEFT END (DOUBLE SICKLE)

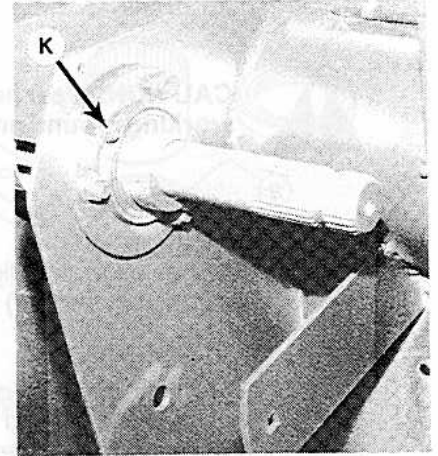

RIGHT END

SICKLE DRIVE SHAFT SUPPORT BEARINGS

2. Cross-Shaft End Support Bearings (L) & (M)  
- two fittings on Double Sickle Header

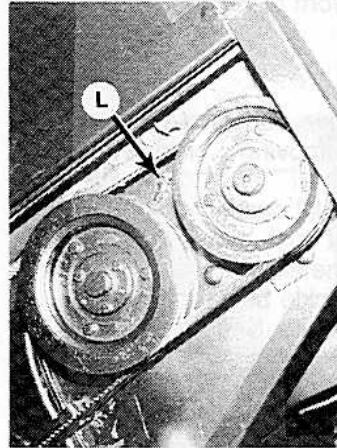

LEFT END

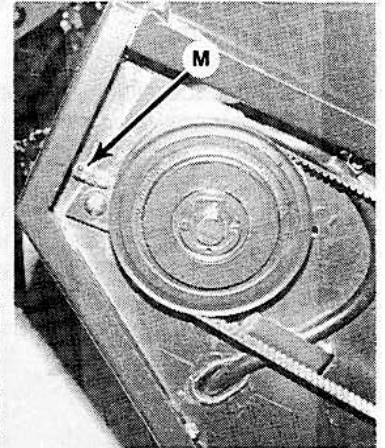

RIGHT END

CROSS-SHAFT END SUPPORT BEARINGS  
(DOUBLE SICKLE HEADER)

3. Upper Cross Auger Support Bearing (optional) (R) - one fitting

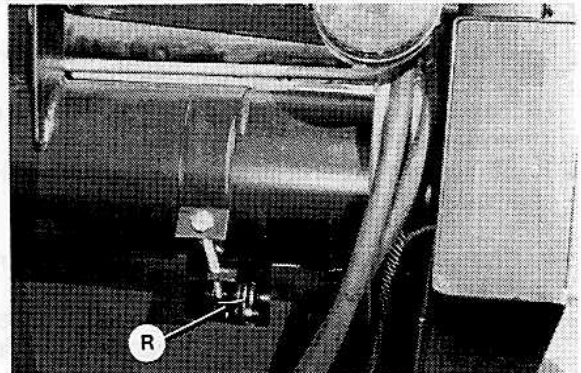

UPPER CROSS AUGER SUPPORT BEARING



## MAINTENANCE/SERVICE

### SICKLE AND SICKLE DRIVE (continued)

#### Guards



**CAUTION:** Always engage reel props before working under reel.

Check daily that guards are aligned to obtain proper shear cut between sickle section and guard. Sickle sections should contact shear surface of each guard.

Align guards with guard straightening tool provided as shown:

To bend guard tips up, position tool as shown at (A) and pull up.

To bend tips down, position tool as at (B) and push down.

See "Unplugging the Header" in Operation section for tool storage.

**TIP:** If trouble is encountered cutting tangled, but easy to cut material (canola, peas, grain) replace guards with stub guards and install a sickle hold-down on every guard. If material is tough to cut, install stub guards with top guard and adjuster plate from the MacDon 930 "Grass Seed Special" Header. A stub guard kit for the 942 Header is available from your dealer.

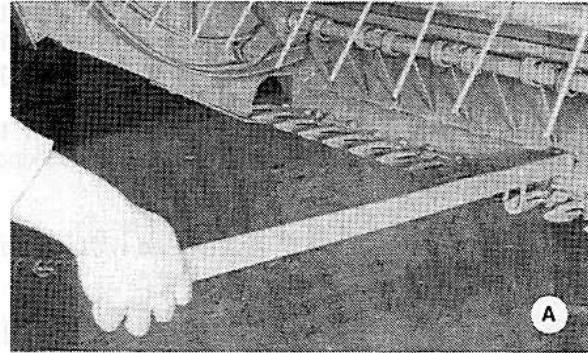

BENDING GUARD TIPS UP

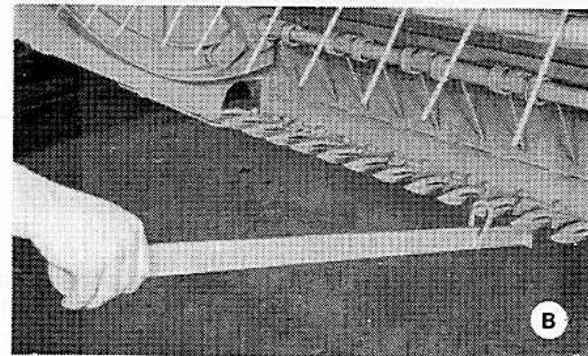

BENDING GUARD TIPS DOWN

#### Sickle Hold-Downs



**CAUTION:** Always engage reel props before working under reel.

Check daily that sickle hold-downs are set to prevent sickle sections from lifting off guards but still permit sickle to slide without binding. Set hold-downs after guards are aligned.

To set hold-downs:

1. Using a flat piece of bar (A), tap end of hold-down as shown. This allows adjustment of hold-down arch (B) without "pinching" sickle. Clearance from hold-down to sickle section should be .02 in. (0.5 mm).
2. After adjusting all sickle hold-downs, run header at a low engine speed and listen for noise due to insufficient clearance. Re-adjust as necessary by placing a .020 in. (0.5 mm) shim between hold-down and section, then striking the hold-down arch (B) with a hammer.

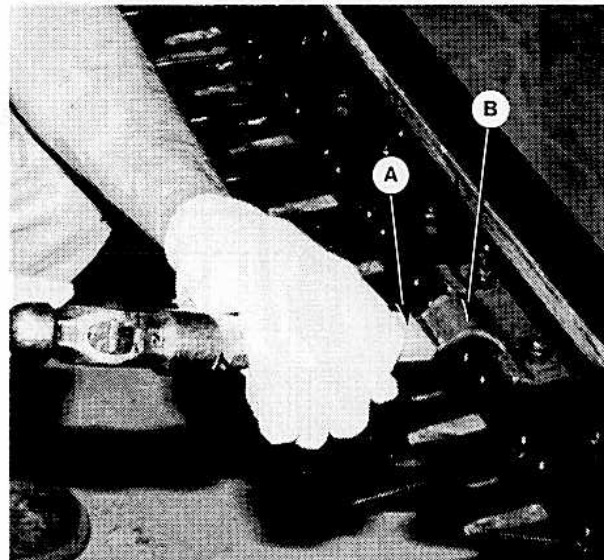

SETTING SICKLE HOLD-DOWNS



## MAINTENANCE/SERVICE

### SICKLE AND SICKLE DRIVE (continued)

#### Sickle Timing (Double Sickle Headers)

To prevent excessive vibration, the left and right sickles must be accurately timed to move in opposite directions. Timing is achieved by rotating the wobble box pulley as required when installing the wobble box drive belts.

To time the sickles:

1. Install the left hand wobble box drive belt and tension as described (next page). Check that the belt is properly seated in the grooves on both driver and driven pulleys.
2. Rotate the left hand wobble box driven pulley clockwise until the left hand sickle (A) is at the center of the inboard stroke (moving towards the center of the header).

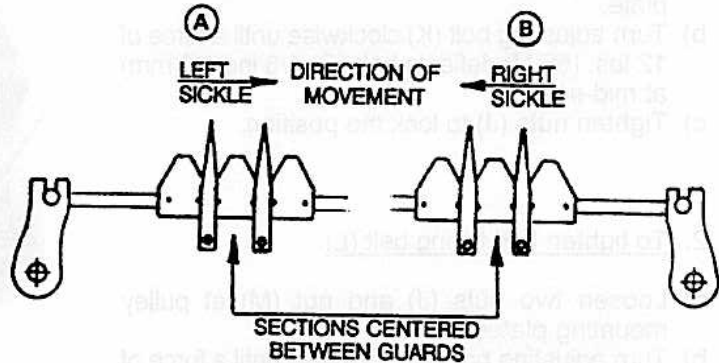

**NOTE:** Center stroke is when the sickle sections are centered between the guard points as shown.

3. Remove the right hand drive belt from the wobble box pulley and rotate the pulley counter-clockwise until the right hand sickle (B) is also at the center of the inboard stroke.  
**IMPORTANT:** It is critical that sickles are centered at guard points while both are moving towards the center of the header, not one moving inboard and one moving outboard.
4. Install the right hand wobble box drive belt and tension as described (next page).  
**NOTE:** To maintain timing, wobble box driver and driven pulleys must not rotate as the belt is tightened. Tighten all hardware and check that the belt is properly seated in the grooves on both driver and driven pulleys.
5. Check for correct sickle timing by rotating the rear cross-shaft slowly. Observe sickles where they over-lap at the center of the header.  
**IMPORTANT:** At the start of each stroke, sickles must move in opposite directions and must begin to move at exactly the same time. If timing is slightly off, loosen right hand belt just enough to allow skipping the belt one or more teeth as required: If R/H sickle "leads" L/H, rotate right hand driven pulley clockwise. If R/H sickle "lags" L/H, rotate pulley counter-clockwise. Tighten right hand belt.

#### Changing Double Sickle Speed

Sickle drive is factory assembled for sickle speed of 1875 strokes per minute (S.P.M.). By exchanging pulleys (A) and (B) sickle speed can be decreased to 1450 S.P.M.

To change sickle speed:

1. Loosen and remove cross-shaft drive belt (G). See "Tightening Double Sickle Drive Belts", below.
2. Remove three bolts (C) and separate pulley (B) from the timing belt pulley.
3. Remove three bolts (D) and separate pulley (A) from drive hub.
4. Exchange positions of pulleys (A) and (B) and reassemble.
5. Tighten cross-shaft drive belt (G) and L/H timing belt (L).

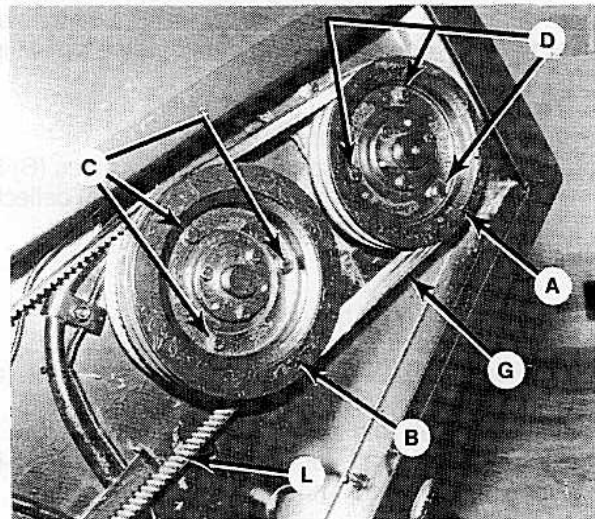

CHANGING SICKLE SPEED

## MAINTENANCE/SERVICE

### Tightening Double Sickle Drive Belts

1. To tighten cross-shaft drive belt (G) only:  
**NOTE:** If timing belt also requires tightening, go to step 2.
  - a) Loosen two nuts (J) at driver pulley mounting plate.
  - b) Turn adjusting bolt (K) clockwise until a force of 12 lbs. (55 N) deflects belt (G) 1/8 inch (3 mm) at mid-span.
  - c) Tighten nuts (J) to lock the position.
2. To tighten L/H timing belt (L):
  - a) Loosen two nuts (J) and nut (M) at pulley mounting plates.
  - b) Turn adjusting bolt (K) clockwise until a force of 6 lbs. (28 N) deflects timing belt (L) 1/2 inch (13 mm) at mid-span.
  - c) Tighten nut (M) to lock the timing belt tension.
  - d) Tighten cross-shaft drive belt as described in steps 1 b) and 1 c).

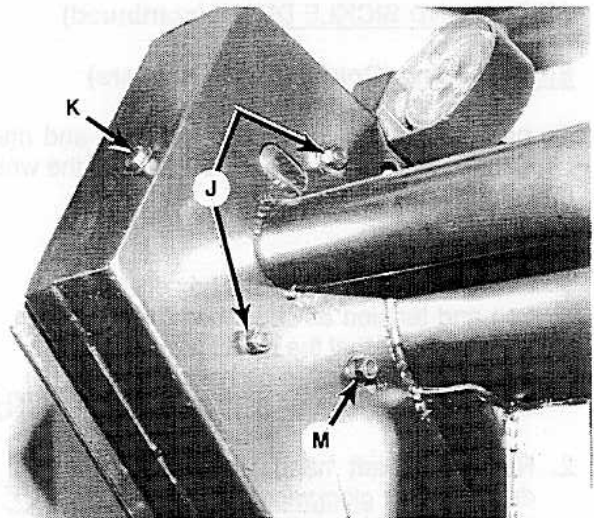

L/H SICKLE DRIVE BELTS  
TENSION ADJUSTMENT

3. To tighten R/H timing belt (P):
  - a) Loosen nut on bolt (R) at R/H driver pulley mounting plate.
  - b) Use a punch or screwdriver in pry holes (S) to move pulley back until a force of 6 lbs. (28 N) deflects timing belt (P) 1/2 inch (13 mm) at mid-span.
  - c) Tighten nut (R) to lock the position.

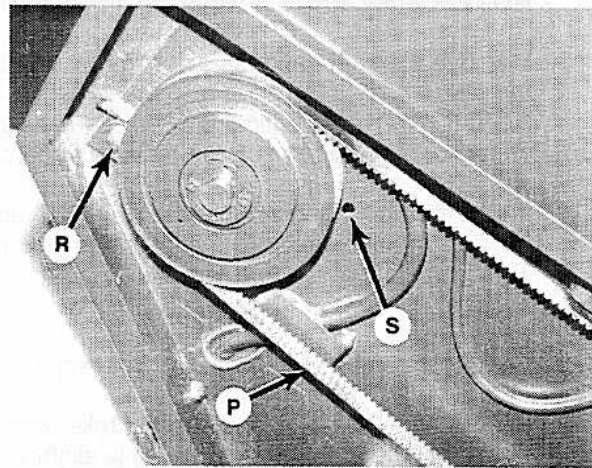

R/H SICKLE DRIVE BELT

### Tightening Single Sickle Drive Belt

**IMPORTANT:** To prolong belt and drive life, do not over tighten belt. Operate at minimum tension required to prevent slipping or excessive belt whip.

To adjust:

1. Loosen idler mounting bolt (A).
2. Use a punch or screwdriver in pry holes (B) to raise idler until a force of 12 lbs. (55 N) deflects belt 1/2 inch (13 mm) at mid-span.
3. Tighten bolt (A).

When installing a new belt:

1. Loosen bolt (A) and move idler fully down.
2. Remove bolt-on panel in left end sheet (at wobble box) for belt removal or installation.
3. Install belt and adjust belt tension as above.
4. Re-adjust belt tension after a short run-in period. (About 5 hours).

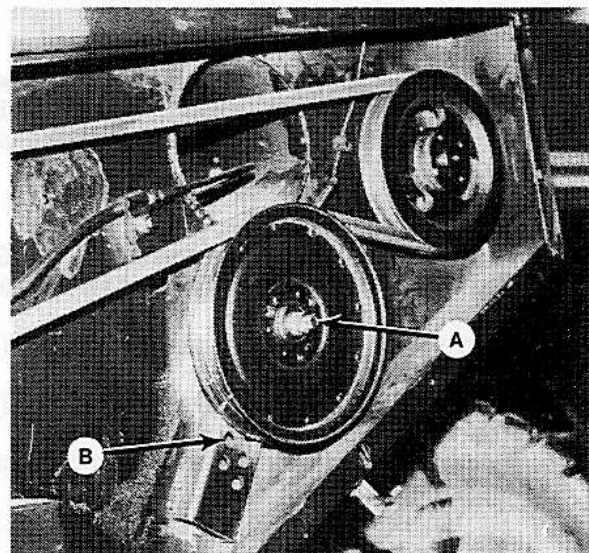

SINGLE SICKLE DRIVE BELT TENSION

## MAINTENANCE/SERVICE

### SICKLE AND SICKLE DRIVE (continued)

#### Wobble Box Maintenance

**NOTE:** For double sickle headers, perform maintenance at both boxes.

**Mounting Bolts** - Check four wobble box mounting bolts (B) torque after the first 10 hours operation and every 100 hours thereafter. Torque should be 200 ft.lbs. (270 N-m). When tightening, start with the side mounting bolts.

**Lubricant** - Check wobble box lubricant level before first operation and every 100 hours thereafter. To check:

1. Raise header to a point where the wobble box base is approximately level.
2. Remove breather (A) and measure down. Oil level should be 2 ½ to 3 ½ inches (65 to 90 mm) from top of hole.

**NOTE:** Use a somewhat flexible measuring device to allow insertion past internal components.

3. Add as required. See "Recommended Lubricants" for specified gear lube and capacity of box.
4. Replace breather.

Change wobble box lubricant after the first 50 hours operation and every 1000 hours (or 3 years) thereafter.

#### Assembly/Disassembly

When reinstalling drive arm or pulley:

1. Remove any rust or paint from inner spline. For replacement parts, remove oil/grease with degreasing agent.
2. Before assembly, apply Loctite® #243 adhesive (or equivalent) to spline. Apply in two bands (C) as shown, with one band at end of spline and one band approximately mid-way.

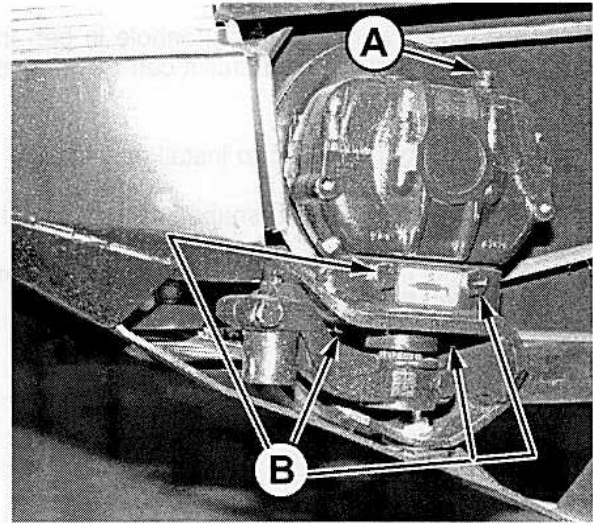
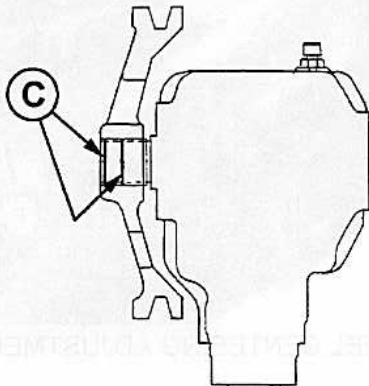

WOBBLE BOX MOUNTING BOLTS & LUBRICANT

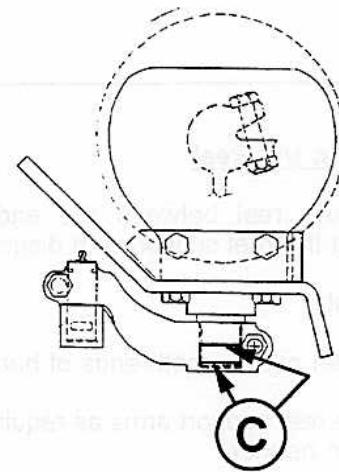

USE ADHESIVE FOR ASSEMBLY



## MAINTENANCE/SERVICE

### REEL AND REEL DRIVE

#### Reel Finger Replacement

To replace a pick-up reel finger:

- a. Insert screwdriver in slot in finger button and tap to push button into bat and down.
- b. Insert screwdriver into buttonhole in bat and pry top of finger down until it can be removed from pocket.
- c. Use the tool supplied to install new finger.

Be sure finger button snaps into hole in bat.

For steel fingers, pre-assemble finger (D) and adapter (E) and install.

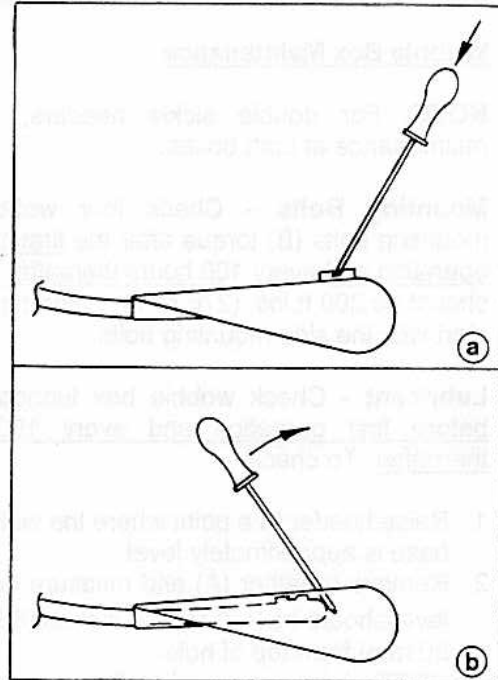

FINGER REMOVAL

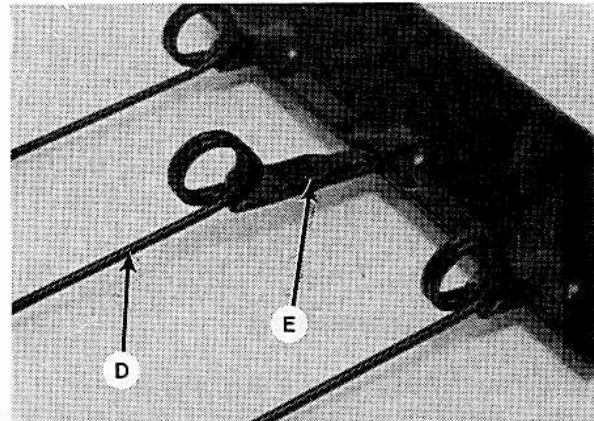

STEEL FINGER ASSEMBLY

#### Centering the Reel

Center the reel between the end sheets by adjusting the reel support arm diagonal braces.

To adjust:

1. Loosen nut (F), both ends of header.
2. Move reel support arms as required to center reel in header.
3. Tighten nut (F), both ends of header.

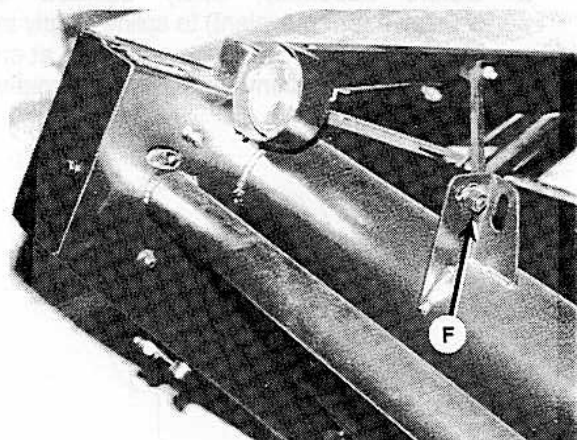

REEL CENTERING ADJUSTMENT

## MAINTENANCE/SERVICE

### REEL AND REEL DRIVE (continued)

#### Reel Clearance to Cutterbar

Reel finger to sickle guard minimum clearance is 3/4 in. (20 mm) with reel fully lowered.

Check reel clearance whenever the reel fore-aft position or finger pitch is changed.

When operating reel with an aggressive finger pitch, be sure that fingers will not contact sickle when flexed back by crop, as at (R).

**NOTE:** Reel fingers should come as close to augers as possible, without contact.

To adjust reel clearance to cutterbar:

1. Lower header and reel fully.
2. Loosen nut (C) and turn nut (B) clockwise to increase clearance to cutterbar, or counter-clockwise to decrease.
3. Tighten nut (C) against nut (B) to secure the position.
4. Repeat at opposite side so clearance is consistent across cutterbar.

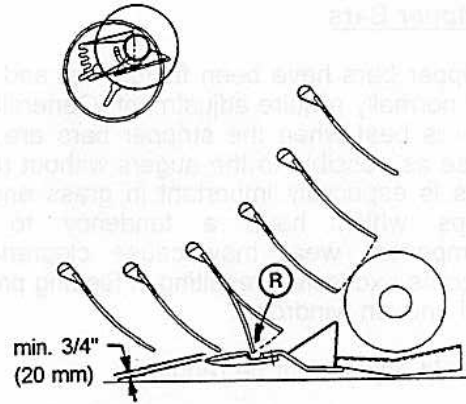

REEL CLEARANCE TO SICKLE AND AUGERS

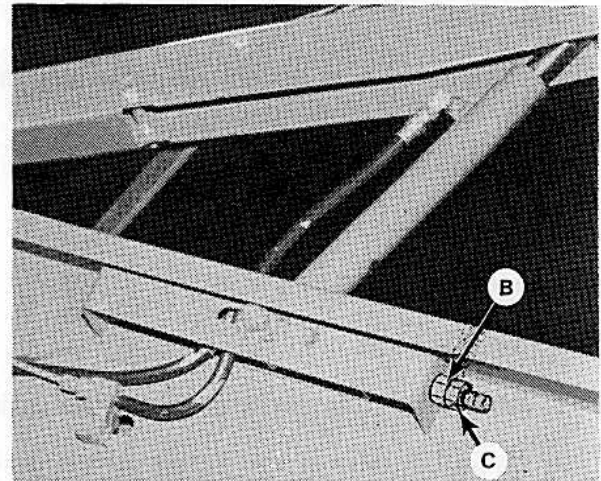

REEL CLEARANCE ADJUSTMENT

#### Reel Drive Chain Tension

Check the reel drive chain tension annually.

To adjust:

1. Loosen four bolts (A).
2. Slide motor away from reel shaft until a force of 11 lbs. (50 N) deflects chain 1/8 in. (3 mm) at mid-span.
3. Tighten bolts (A).

#### Reel Drive Chain Lubrication

Lubricate full length of chain annually with Multi-Purpose Grease.

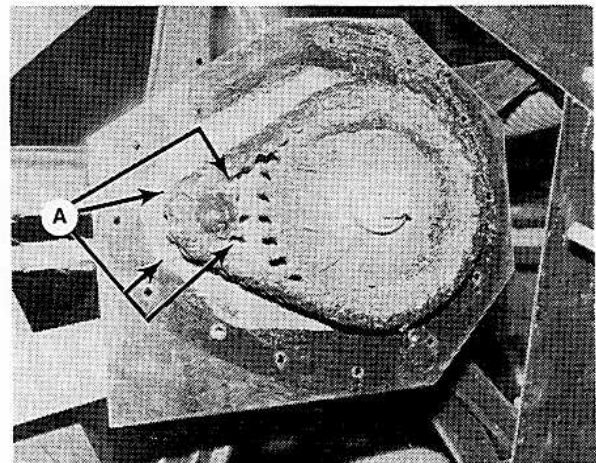

REEL DRIVE CHAIN TENSION AND LUBRICATION



## MAINTENANCE/SERVICE

### AUGERS AND AUGER DRIVE

#### Stripper Bars

Stripper bars have been factory set and should not normally require adjustment. Generally, crop flow is best when the stripper bars are set as close as possible to the augers without rubbing. This is especially important in grass and other crops which have a tendency to wrap. Component wear may cause clearances to become excessive, resulting in feeding problems and uneven windrows.

Should adjustment be required:

1. Loosen stripper bar mounting bolts (A).
2. Position stripper bars as close as possible to augers.
3. Check that bars do not rub augers at any point.
4. Tighten bolts (A).

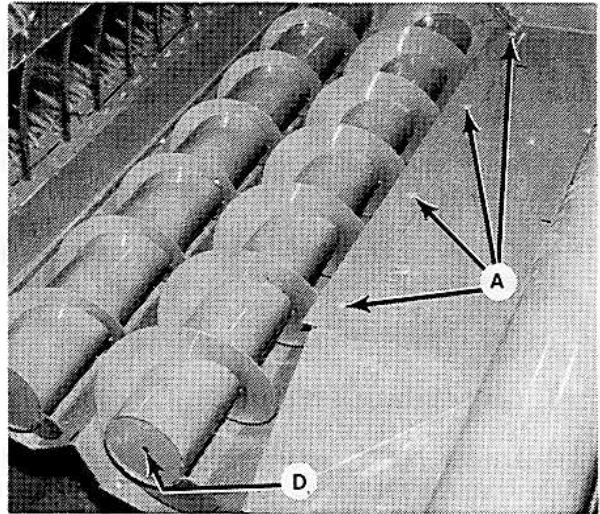

STRIPPER BAR ADJUSTMENT

#### Auger Removal

To remove auger:

1. Insert a jamming device in auger drive chain.
2. Use a 1/2" drive pin in hole (D) and turn auger in its normal direction of rotation.

## MAINTENANCE/SERVICE

### AUGERS AND AUGER DRIVE (continued)

#### Front Augers Drive Chain Tension

Check auger drive chain tension annually.

To tighten front augers drive chain:

1. Remove chain drive shield.
2. Loosen idler sprocket mounting bolt (A).
3. Move idler downward until deflection at (B) is 1/4 inch (6 mm).
4. Tighten bolt (A) and replace drive shield.
5. Repeat on opposite side of header.

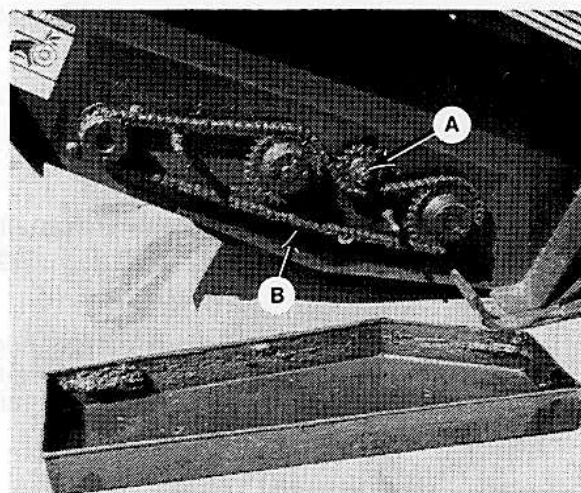

CHAIN TENSION AND LUBRICATION  
(BOTH SIDES)

#### Front Augers Drive Chain Lubrication

Lubricate chain (both sides of header) annually with Multi-Purpose Grease.

## HYDRAULIC SYSTEM

### Hydraulic Hoses and Lines

Check hydraulic hoses and lines daily for signs of leaks.



**WARNING:** Avoid high-pressure fluids. Escaping fluid can penetrate the skin causing serious injury. Relieve pressure before disconnecting hydraulic lines. Tighten all connections before applying pressure. Keep hands and body away from pin-holes and nozzles which eject fluids under high pressure. Use a piece of cardboard or paper to search for leaks. IF ANY fluid is injected into the skin, it must be surgically removed within a few hours by a doctor familiar with this type of injury or gangrene may result.

**IMPORTANT:** Dirt, dust, water and foreign material are the major causes of trouble developing in the hydraulic system. DO NOT attempt to service hydraulic system in the field. Precision fits require WHITE ROOM CARE during overhaul.

The header's hydraulic circuits require no periodic maintenance. See "Hydraulic System" in the Maintenance/Service section of the Windrower Tractor Operator's Manual for total system care.



AVOID HIGH PRESSURE FLUIDS



CHECK PROPERLY FOR LEAKS

## MAINTENANCE/SERVICE

### HAY CONDITIONER

#### Hay Conditioner Drive Chain Lubrication

Lubricate chain daily with a light weight oil (SAE 30).

#### Hay Conditioner Drive Chain Tension

Check hay conditioner drive chain tension after the first 2 hours operation and every 100 hours thereafter.

To check chain tension: Place a straight-edge across idler sprockets as shown. Light pressure at mid-span should produce 5/8 in. (15 mm) deflection.

If adjustment is required:

1. Loosen nut (A).
2. Back off nut (D) and turn nut (E) to push sprocket rearward to increase tension to above specification. Do not over-tighten.
3. Tighten nuts (A) and (D) to secure the position.

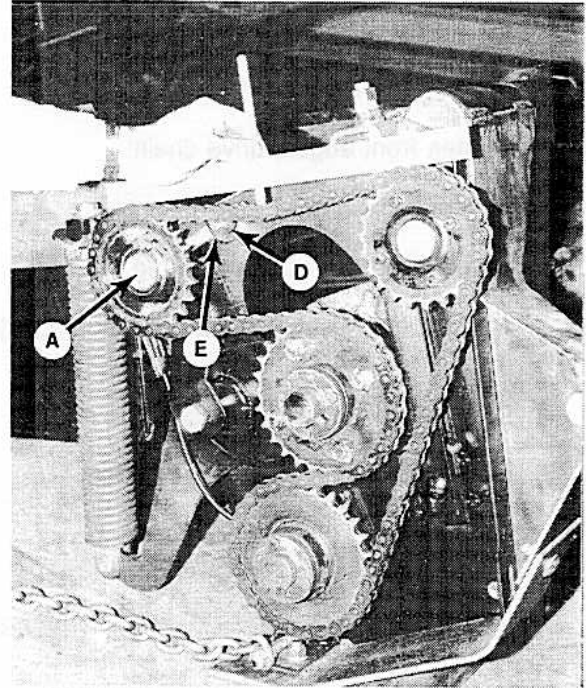

CONDITIONER DRIVE CHAIN TENSION

#### Hay Conditioner Roll Timing

Rolls must be timed to prevent contact between bars. Bars of one roll must be approximately centered between bars of the other roll as illustrated.

When installing roll drive chain:

1. Rotate rolls to approximately correct timing.
2. Install chain.
3. Set roll timing as follows:
  - Loosen four nuts (A) at upper roll sprocket.
  - Rotate sprocket to achieve best roll timing.
  - Tighten nuts (A) to secure the position.

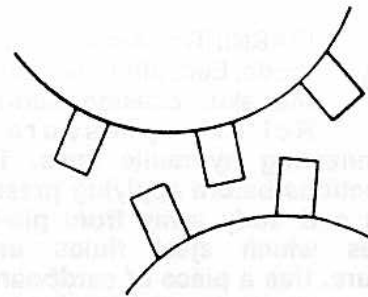

PROPER ROLL TIMING

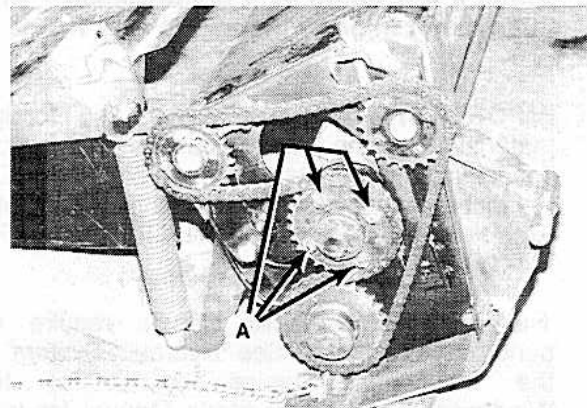

ROLL TIMING ADJUSTMENT

# MAINTENANCE/SERVICE

## MAINTENANCE SCHEDULE

The following maintenance schedule is a listing of periodic maintenance procedures, organized by service intervals. For detailed instructions, see the specific headings in Maintenance/ Service section. Use "Recommended Fluids and Lubricants" as specified under that heading.

### Service Intervals

The recommended service intervals are in hours of operation. Use the hour meter in the windrower cab to indicate when the next service interval has been reached.

**IMPORTANT:** Recommended intervals are for average conditions. Service the machine more often if operated under adverse conditions (severe dust, extra heavy loads, etc.).

Regular maintenance is the best insurance against early wear and untimely breakdowns. Following this schedule will increase machine life.

Where a service interval is given in more than one time frame, eg. "100 hours or Annually", service the machine at whichever interval is reached first.



**CAUTION: Carefully follow safety messages given under "Service Procedures".**

# MAINTENANCE/SERVICE

## MAINTENANCE SCHEDULE

AT FIRST USE: See "Break-In Period" in Operation section.

---

### DAILY

1. Oil sickle (except in sandy conditions).
  2. Check sickle sections, guards and hold-downs.
  3. Check hydraulic hoses and lines for leaks.
  4. Oil hay conditioner drive chain.
- 

### 25 HOURS

1. Grease sickle head(s).
  2. Grease cross-shaft support tube - double sickle headers.
- 

### 50 HOURS

1. Grease reel center tube bearings.
  2. Grease hay conditioner roll bearings.
  3. Grease hay conditioner belt idler pulley bearings.
- 

### 100 HOURS OR ANNUALLY \*

1. Grease sickle drive shaft support bearings.
2. Grease cross-shaft end support bearings - double sickle headers.
3. Grease upper cross auger support bearing. (Option)
4. Check wobble box mounting bolt torque.
5. Check wobble box lubricant level.
6. Check reel drive chain tension.
7. Grease reel drive chain.
8. Check auger drive chains tension.
9. Grease auger drive chains.
10. Check hay conditioner drive chain tension.

\*It is recommended that Annual Maintenance be down prior to start of operating season.

---

END OF SEASON: See "Storage Procedure" in Operation section.

---

### 1000 HOURS OR 3 YEARS

1. Change wobble box lubricant.



# MAINTENANCE RECORD

Header Serial No. \_\_\_\_\_

Hay Conditioner Serial No. \_\_\_\_\_

Combine this record with Windrower Maintenance Record for "complete unit" service.  
See Maintenance/Service section for details on each procedure. Copy this page to continue record.

**(D) - Double Sickle Headers Only**

**(O) - Optional Equipment**

ACTION:	✓ - Check	● - Lubricate	▲ - Change																				
<b>Hour Meter Reading:</b>  <b>Serviced By:</b>  <b>Maintenance Procedure</b>																							
<b>BREAK-IN</b>		See "Break-In Period" in Operation section for checklist.																					
<b>DAILY</b>																							
●	Sickle Assembly																						
✓	Sections, Guards, Hold-downs																						
✓	Hydraulic Hoses																						
●	Conditioner Drive Chain																						
<b>25 HOURS</b>																							
●	Sickle Head																						
●	Cross-Shaft Support Tube (D)																						
<b>50 HOURS</b>																							
●	Reel Center Tube Bearings																						
●	Conditioner Roll Bearings																						
●	Cond. Belt Idler Pulley Brgs.																						
<b>100 HOURS OR ANNUALLY</b>																							
●	Drive Shaft Support Bearings																						
●	Cross-Shaft End Bearings (D)																						
●	Upper Cross Auger Brg. (O)																						
✓	Wobble Box Bolt Torque																						
✓	Wobble Box Lubricant Level																						
✓	Reel Drive Chain Tension																						
●	Reel Drive Chain																						
✓	Auger Drive Chains Tension																						
●	Auger Drive Chains																						
✓	Cond. Drive Chain Tension																						
<b>STORAGE</b>		See "Storage Procedure" in Operation section for checklist.																					
<b>1000 HOURS OR 3 YEARS</b>																							
▲	Wobble Box Lubricant																						

## TROUBLESHOOTING

<u>SYMPTOM</u>	<u>PROBLEM</u>	<u>SOLUTION</u>	<u>REF.</u>
<b>CROP LOSS AT CUTTERBAR</b>			
Does not pick-up down crop.	Cutterbar too high.	Lower cutterbar.	22
	Header angle too flat.	Steepen header angle.	*
	Reel too high.	Lower reel.	24
	Reel too far back.	Move reel forward (maximum sixth hole).	25
	Ground speed too fast for reel speed.	Reduce ground speed or increase reel speed.	23
		24	
	Reel fingers not lifting crop sufficiently.	Move cam arms to pos'n. Y to increase finger pitch aggressiveness.	26
	Install lifter guards.	**	
Heads shattering or breaking off.	Reel speed too fast.	Reduce reel speed.	24
	Reel too low.	Raise reel.	24
	Ground speed too fast.	Reduce ground speed.	23
	Crop too ripe.	Operate at night when humidity is higher.	---
Cut grain falling ahead of cutterbar.	Ground speed too slow.	Increase ground speed.	23
	Reel speed too slow	Increase reel speed.	24
	Reel too high.	Lower reel.	24
	Cutterbar too high.	Lower cutterbar.	22
	Reel too far forward.	Move reel back on support arms.	25
	Worn or broken sickle components.	Replace.	44
Strips of uncut material.	Crowding uncut crop.	Allow enough room for crop to be fed to cutterbar.	---
	Broken sickle sections.	Replace.	44

\* See your Windrower Tractor Operator's manual.

\*\* See your Windrower dealer.

## TROUBLESHOOTING

<u>SYMPTOM</u>	<u>PROBLEM</u>	<u>SOLUTION</u>	<u>REF.</u>
<b>CROP LOSS AT CUTTERBAR (continued)</b>			
Crop not being cut at ends.	Reel too high or not centered in header.	Lower reel or adjust horizontal position.	24 50
	Sickle hold-downs not adjusted properly.	Adjust hold-downs so sickle works freely, but still keep sections from lifting off guards.	46
	Sickle sections or guards are worn or broken.	Check and replace all worn and broken cutting parts.	44
	Header is not level.	Level header.	*
	Reel fingers not lifting crop properly ahead of sickle.	Increase finger pitch aggressiveness.	26
	Divider runs down thick crop at ends, preventing proper feeding.	Replace 3 or 4 end guards with stub guards.	**

### CUTTING ACTION & SICKLE COMPONENTS

Ragged or uneven cutting of crop.	Sickle hold-downs not adjusted properly.	Adjust hold-downs so sickle works freely, but still keep sections from lifting off guards.	46
	Sickle sections or guards are worn or broken.	Check and replace all worn and broken cutting parts.	44
	Sickle is not operating at recommended speed.	Check engine speed of windrower.	*
	Ground speed too fast for reel speed.	Reduce ground speed or increase reel speed.	23 24
	Reel fingers not lifting crop properly ahead of sickle.	Increase finger pitch aggressiveness.	26
	Cutterbar too high.	Lower cutting height.	22
	Header angle too flat.	Steepen header angle.	*
	Bent sickle, causing binding of cutting parts.	Straighten a bent sickle. Align guards.	45 46

\* See your Windrower Tractor Operator's Manual.

\*\* See your Windrower dealer.

## TROUBLESHOOTING

<u>SYMPTOM</u>	<u>PROBLEM</u>	<u>SOLUTION</u>	<u>REF.</u>
<b>CUTTING ACTION &amp; SICKLE COMPONENTS</b>			
Ragged or uneven cutting of crop. (continued)	Cutting edge of guards not close enough or parallel to sickle sections.	Align guards.	46
	Tangled or tough to cut crop.	Install stub guards.	46
	Reel too far back.	Move reel forward. (Maximum sixth hole.)	25
	Loose sickle drive belt.	Adjust drive belt tension.	48
Sickle plugging.	Reel too high or too far forward.	Lower reel or move reel rearward.	24 25
	Ground speed too slow.	Increase ground speed.	23
	Loose sickle drive belt.	Adjust drive belt tension.	48
	Improper sickle hold-down adjustment.	Adjust hold-down so sickle is held against guard cutting surface.	46
	Dull or broken sickle sections.	Replace.	44
	Bent or broken guards.	Align or replace.	46
	Reel fingers not lifting crop properly ahead of sickle.	Increase finger pitch aggressiveness.	26
	Steel pick-up fingers contacting sickle.	Increase reel clearance to cutterbar.	51
	Header float too heavy.	Adjust float springs for lighter float.	*
	Mud or dirt build-up on cutterbar.	Raise cutterbar by lowering skid shoes.	22
	Flatten header angle.	*	
	Sickle is not operating at recommended speed.	Check engine speed of windrower.	*

\* See your Windrower Tractor Operator's Manual.

## TROUBLESHOOTING

<u>SYMPTOM</u>	<u>PROBLEM</u>	<u>SOLUTION</u>	<u>REF.</u>
<b>CUTTING ACTION &amp; SICKLE COMPONENTS (continued)</b>			
Excessive header vibration.	Sickle not operating at recommended speed.	Check engine speed of windrower.	*
	Excessive sickle wear.	Replace sickle.	45
	Loose or worn sickle head pin or drive arm.	Tighten or replace parts.	45
Excessive breakage of sickle sections or guards.	Cutterbar operating too low in stony conditions.	Raise cutterbar, using skid shoes.	22
	Header float is set too heavy.	Adjust float springs for lighter float.	*
	Bent or broken guard.	Straighten or replace.	46
	Header angle too steep.	Flatten header angle.	*
Sickle back breakage.	Bent or broken guard.	Straighten or replace.	46
	Worn sickle head pin.	Replace.	45
	Dull sickle.	Replace.	45
<b>REEL DELIVERY</b>			
Reel not releasing crop.	In heavy crop, fingers starting to flip over before releasing crop.	Move to a <u>more</u> aggressive finger pitch notch.	26
	In light crop, cam arms in position Y.	Move cam arms to position X.	26
	Reel speed too fast.	Reduce speed of reel to allow crop to fall onto augers properly. Reel speed should be slightly faster than ground speed.	24
	Reel too low.	Raise reel.	24
	Reel too far back.	Move reel forward. (Maximum sixth hole.)	25

\* See your Windrower Tractor Operator's Manual.



## TROUBLESHOOTING

<u>SYMPTOM</u>	<u>PROBLEM</u>	<u>SOLUTION</u>	<u>REF.</u>
<b>REEL (continued)</b>			
Wrapping on reel end.	Finger pitch too aggressive.	Decrease finger pitch aggressiveness.	26
	Reel too low.	Raise reel.	24
	Reel speed too fast.	Reduce reel speed.	24
	Reel not centered in header.	Center reel in header.	50
Reel releases crop too quickly.	Finger pitch not aggressive enough.	Increase finger pitch aggressiveness.	26
	Reel too far forward.	Move reel back.	25
Reel will not lift.	Reel lift couplers are incompatible.	Change quick coupler.	---
Reel will not turn.	Control set at 0.	Activate reel speed control.	*
	Quick couplers not properly connected.	Connect couplers.	*
	Final drive chain disconnected.	Connect chain.	51
Reel motion is uneven in heavy crop.	Reel speed too fast.	Reduce reel speed.	23
	Reel taking too much "bite" at crop entry.	Move cam arms to position Y.	26
	Reel fingers not aggressive enough.	Move to a more aggressive finger pitch notch.	26
	Reel too low.	Raise reel.	24
	Relief pressure too low.	Increase relief pressure.	*
	Relief valve malfunction.	Replace relief valve.	-
Early wear and/or destruction of cam components.	Reel adjustments not the same at both ends of reel.	Adjust cam arm position, finger pitch range slot and notch to same at both ends.	26
Premature failure of cam arm bearings.	Cam arms bent, causing bearing misalignment.	Straighten cam arms to set bearings parallel.	-
Destruction of end shields.	Reel not centered.	Center reel in header.	50

\* See your Windrower Tractor Operator's Manual.

## TROUBLESHOOTING

<u>SYMPTOM</u>	<u>PROBLEM</u>	<u>SOLUTION</u>	<u>REF.</u>
<b>AUGER FEEDING &amp; DRIVE</b>			
Crop builds up on augers.	Cutterbar too low.	Raise cutting height.	22
	Auger speed too slow.	Increase auger speed.	28
	Reel too far back.	Move reel forward (maximum sixth hole).	25
	Reel speed too fast.	Reduce reel speed.	24
	Reel too low.	Raise reel.	24
	Ground speed too fast.	Reduce ground speed.	23
Bunchy feeding from cutterbar to augers.	Reel too far forward.	Move reel back on support arms.	25
	Reel too high.	Lower reel.	24
	Reel speed too slow.	Increase reel speed.	24
	Cutterbar too high.	Lower cutting height.	22
	Ground speed too slow.	Increase ground speed.	23
	Augers will not turn.	Control set at 0.	Activate conveyor speed control.
Quick couplers not properly connected.		Connect couplers.	*
Final drive chain disconnected.		Connect chain.	53
<b>HEADER</b>			
Header lift insufficient.	Low relief pressure.	Increase relief pressure.	*
Header suddenly stops turning.	Sickle or hay conditioner plugged.	Turn mechanism in reverse and remove wad.	36
<b>HAY CONDITIONER</b>			
Hay conditioner rolls will not turn.	Obstruction or wad in conditioner rolls.	Turn mechanism in reverse and remove wad.	36
	Drive belt too loose.	Tighten conditioner drive belt.	15

\* See your Windrower Tractor Operator's Manual.

## TROUBLESHOOTING

<u>SYMPTOM</u>	<u>PROBLEM</u>	<u>SOLUTION</u>	<u>REF.</u>
<b>HAY CONDITIONER (continued)</b>			
Over-conditioning of crop.	Excessive intermesh of hay conditioner rolls.	Reduce intermesh of rolls.	30
Under-conditioning of crop.	Insufficient intermesh of hay conditioner rolls.	Increase intermesh of rolls.	30
<b>WINDROW FORMATION - HAY</b>			
Windrow too wide.	Windrow forming shields positioned too far apart.	Position shields closer together.	33
Windrow too narrow.	Windrow forming shields positioned too close together.	Position shields farther apart.	33
	Deflector fins on forming shield improperly adjusted.	Adjust fins.	33
Windrow uneven.	Forming shields too low.	Raise forming shields.	33
	Deflector fins on forming shield improperly adjusted.	Adjust fins. Add extra fins for widest windrows.	33
	Excessive clearance between augers and stripper bars.	Position stripper bars closer to augers.	52
Windrow lacks shape.	Forming shields too high.	Lower forming shields	33
	Deflector fins on forming shield improperly adjusted.	Adjust fins.	33
Hay conditioner not picking up all crop.	Conditioner rolls positioned too high.	Lower conditioner rolls.	31
Hay conditioner bottom roll being damaged by rocks.	Conditioner rolls positioned too low.	Raise conditioner rolls.	31
Running over previous windrow or irrigation row when turning.	Model 9000 tractor wheelbase too long.	Reverse walking beam.	**

\*\* - See your Windrower dealer.

## ATTACHMENTS

Consult your Windrower Dealer for details on the following Options and Attachments.

### UPPER CROSS AUGER

WholeGoods order number:

12' – B2209

15' – B2210

18' – B2211

For tall or bulky crops, the upper cross auger will aid crop flow across the header and through the delivery opening.

Installation instructions are included with the cross auger. Maintenance and operating instructions are included in this manual.

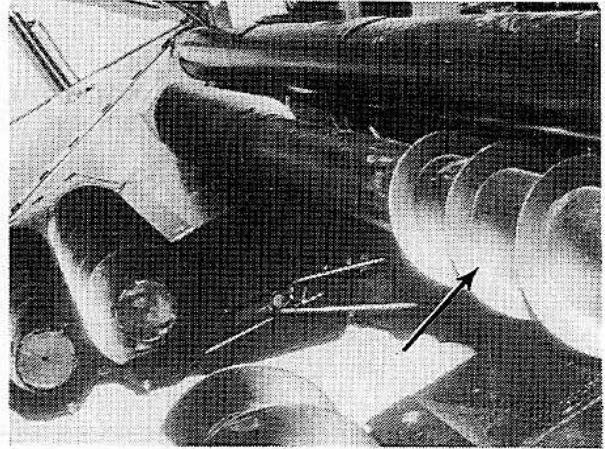

UPPER CROSS AUGER

### HAY CONDITIONER

WholeGoods order number: C1628

The header mounted hay conditioner, with intermeshing steel rolls, crimps plant stems in several places, allowing moisture release for quicker drying.

Information on attaching, operating and servicing the hay conditioner is included throughout this manual.

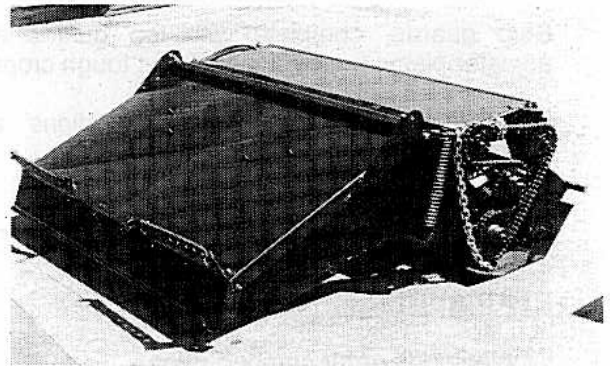

HAY CONDITIONER

### FORMING RODS

WholeGoods order number: B2492

Forming rods assist formation of the desired windrow when a hay conditioner is not installed.

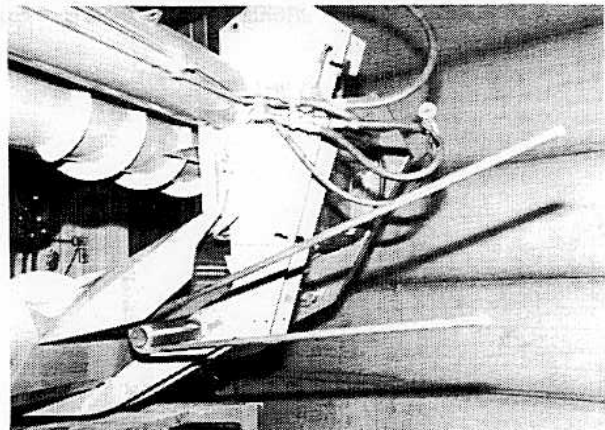

FORMING RODS

## ATTACHMENTS

### STEEL PICK-UP FINGERS

WholeGoods order number:

12' - C1347

15' - C1349

18' - C1351

Attaching to reel bat with plastic adapter (A), the steel finger is available as an alternative to the standard plastic finger.

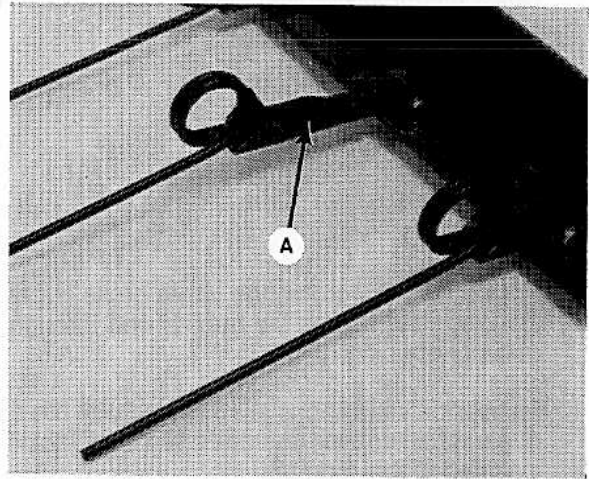

PICK-UP REEL STEEL FINGER

### STUB GUARD CONVERSION KIT

WholeGoods order number:

12' - B2520

15' - B2521

18' - B2522

Stub guards, complete with top guides and adjuster plates are designed to cut tough crops.

Installation and adjustment instructions are included with the kit.

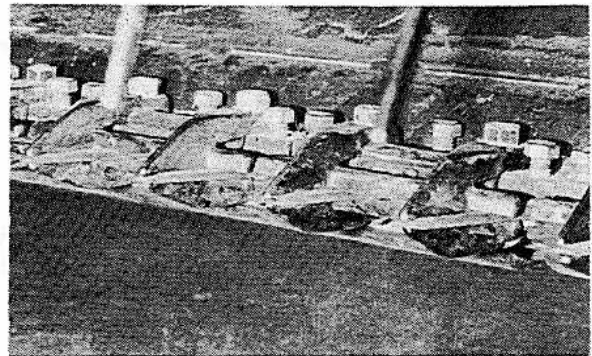

STUB GUARDS

### REAR AUGER EXTENSIONS

WholeGoods order number: B2513

Allow narrowing of delivery opening to 940 Multi-Crop Header width. These extensions are required when 940 Hay Conditioner is used on 942 Header. They may also be beneficial in grain windrow formation under certain conditions. Installation instructions are included with the auger extensions.



## UNLOADING & ASSEMBLY

### PREPARE TO UNLOAD



**CAUTION:** To avoid injury to bystanders from being struck by machinery, do not allow persons to stand in unloading area.

1. Move trailer into position and block trailer wheels.
2. Lower trailer storage stands.
3. Check that the load has not shifted or otherwise become unstable and check shipping stands for damage before removing hauler's tie-downs. If it appears load is unstable, take precautions to prevent machines falling down when tie-downs are removed.

### UNLOADING EQUIPMENT



**CAUTION:** Unloading equipment must meet or exceed specified requirements. Using inadequate equipment may result in vehicle tipping, chain breakage, or machine damage.

**LIFTING VEHICLE REQUIREMENTS:** Use a lifting vehicle with minimum 3500 lb. (1590 kg) lifting capacity and a minimum 15 ft. (4.5 m) lifting height.

**CHAIN REQUIREMENTS:** Use overhead lifting quality chain (1/2 in.) with minimum 5000 lb. (2270 kg) working load limit. Chain length must be sufficient to provide minimum 4 ft. (1.2 m) vertical chain height.

### UNLOAD HEADER

1. Attach chain hooks at points (A) and (B) marked "Lift Here".



**CAUTION:** To avoid injury from shifting or falling machines, remove hauler's tie-downs from one header at a time, after it is secured to unloading vehicle.

2. Remove hauler's tie-down straps and chains.

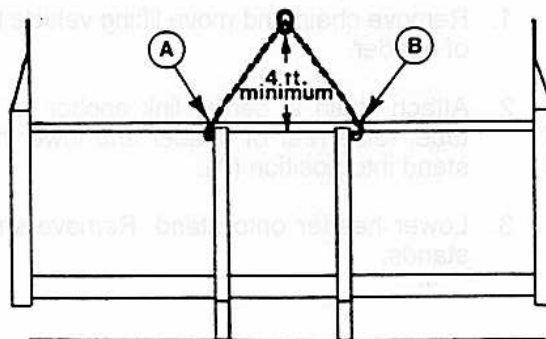

ATTACH CHAIN HOOKS



**CAUTION:** Be sure hooks are secure before moving away from load. Stand clear when lifting, machine may swing. Do not allow anyone to walk under or near the header as it is unloaded or moved.

3. Raise header 12 inches (300 mm) and remove from trailer.
4. Take to storage or set-up area.
5. Set header down securely on level ground. Check for shipping stand damage and remove dividers and other attachments wired to underside of header.
6. Remove chain hooks.



**WARNING:** Header shipping stands are designed for shipping economy. They do not provide a base broad enough for storage of units in an upright position.

To avoid personal injury, death or machine damage from headers falling or blowing over, proceed with instructions to "Lower Header" (next page) before leaving units in storage.

If it is necessary to store machines upright on shipping stands, ensure that the ground is firm and level. Take factors such as exposure to wind, and the effects of snow melt and ground thaw into consideration. Tie units together and brace on both sides, or place against a secure backstop and brace the unsupported side.

## UNLOADING & ASSEMBLY

### LOWER HEADER

1. Drive lifting vehicle to approach header from its "underside".

Attach chain hooks to points (A) and (B) marked "Lift Here". See "Chain Requirements" in this section for minimum chain specs.

2. Set blocks to support header at cutterbar and header support stand as specified under "Attaching the Header" in your Windrower Tractor Operator's Manual.
3. Raise lifting apparatus to take some of the weight off shipping stands and back up SLOWLY to lower the header.

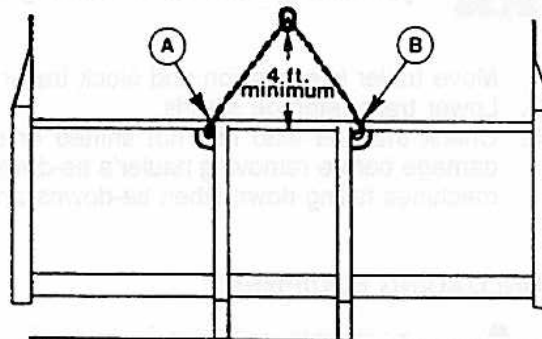

ATTACH CHAIN HOOKS



**CAUTION:** Stand clear when lowering, as machine may swing.

### SET HEADER SUPPORT STAND

1. Remove chain and move lifting vehicle to rear of header.
2. Attach chain to center link anchor on frame tube, raise rear of header and lower header stand into position (A).
3. Lower header onto stand. Remove shipping stands.

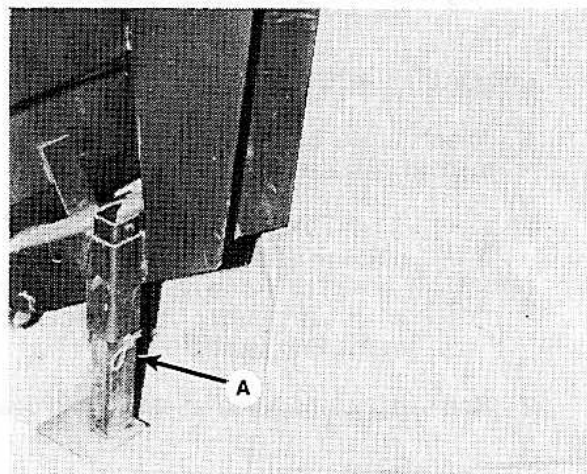

HEADER STAND - LOWERED

### ASSEMBLE AND MOUNT PICK-UP REEL

See Assembly Instructions in booklet shipped in wooden crate of reel parts.

**IMPORTANT:** To prevent damage to the reel from contact with divider rods, do not position reel forward of the sixth hole from the front of the reel support arms. The eighth hole is recommended as a starting point.

**IMPORTANT:** To prevent twisting damage to the reel, bleed reel lift hydraulics before installing finger pitch adjustment bolts. See "Bleed Hydraulic System" in this section.

## UNLOADING & ASSEMBLY

### ADJUST REEL CLEARANCE TO CUTTERBAR

See "Reel Clearance to Cutterbar" in Maintenance/Service section.

### ATTACH DIVIDERS

**IMPORTANT:** To prevent damage to divider brace arms, do not attach dividers until reel is positioned properly on support arms and reel clearance to cutterbar is set. (See above.)

1. Attach dividers to header end panels, using three 1/2 x 1 carriage head bolts (A) and one 1/2 x 1 1/4 carriage head bolt (D) per divider. Install bolt heads to the top and inside, where crop will contact the divider.

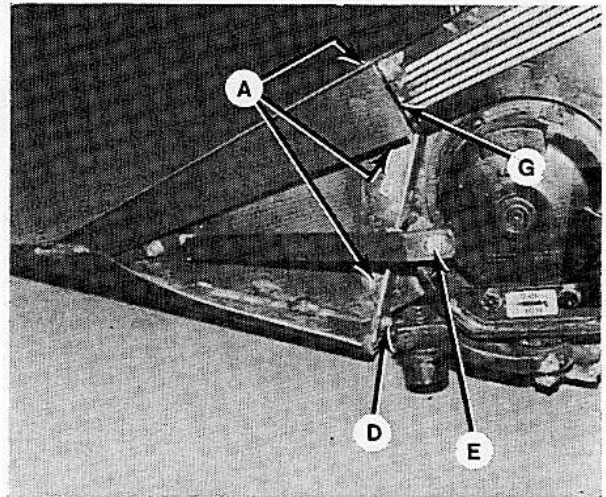

**NOTE:** Divider is positioned to retain the left hand drive shield hinge pin. Leave a 1/8" (3 mm) gap between divider and shield at (G). Check that shield can be opened freely without binding.

2. Attach L/H lower brace to wobble box at (E), using bolt installed in the box.

Attach R/H lower brace to end panel, using one 1/2 x 1 1/4 carriage head bolt (F).

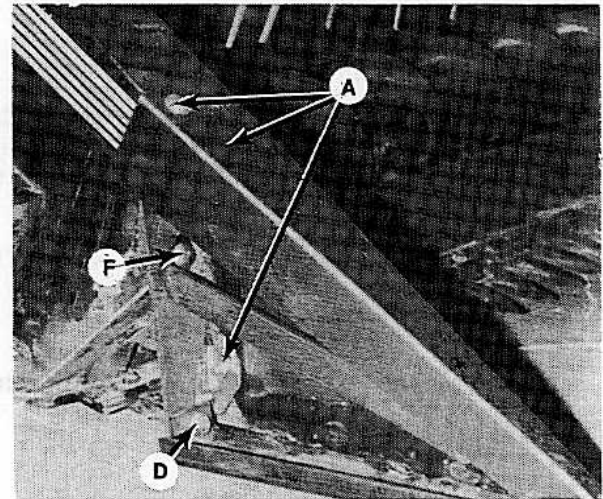

ATTACH DIVIDERS

3. Attach divider brace arm (H) to reel support arm using 3/8 x 2 3/4 hex bolt, (bolt head outside). Do not over tighten, as brace arm must pivot as reel is raised and lowered.

**NOTE:** Depending on reel height, it may be necessary to deflect divider rod and bend brace arm to align parts for installation of hardware. During operation, divider rod will deflect as reel is raised and lowered.

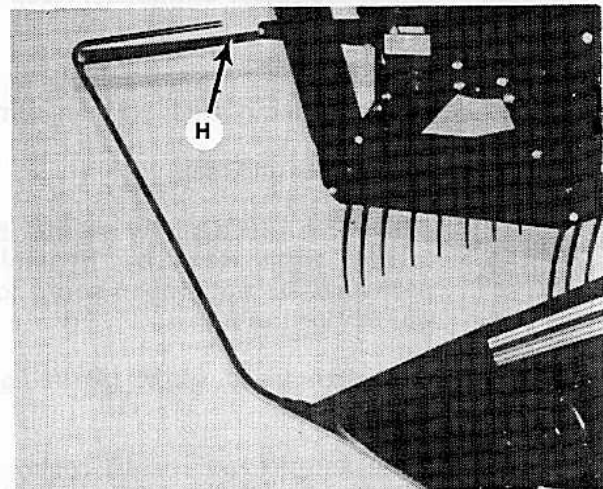

ATTACH BRACE ARM

## UNLOADING & ASSEMBLY

### ATTACH FORMING RODS (OPTIONAL)

Attach forming rods (C) to left and right header lift legs.

**NOTE:** Longer rod goes on top, and large washer goes between bolt head and header leg.

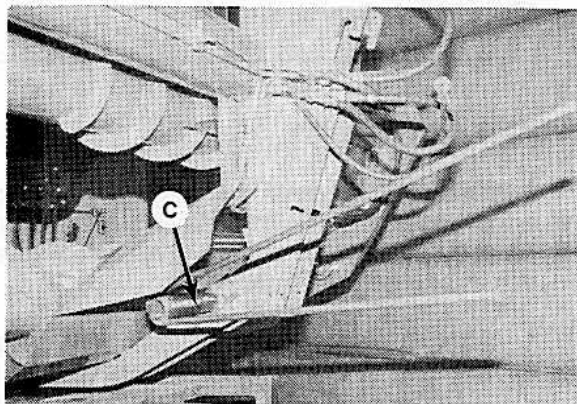

ATTACH FORMING RODS

### ATTACH HEADER



**CAUTION:** Read the Operator's Manuals carefully to familiarize yourself with procedures and controls before attaching header to tractor. Attaching instructions are provided in the Windrower Tractor Operator's Manual.

### BLEED HYDRAULIC SYSTEM

#### Header Lift Cylinders

Raise and lower header a few times to allow trapped air to pass back to the reservoir.

#### Reel Lift Cylinders



**CAUTION:** Take care during this procedure as air in the system can cause the reel to raise and lower erratically. Keep body and hands out from under reel and reel support arms.

**IMPORTANT:** To prevent twisting damage to pick-up reel and lean bar supports, complete the following procedure before installing finger pitch adjustment bolts.

1. Fully lower header and reel.



**CAUTION:** Bleed screw (A) may be forced from hole by hydraulic pressure. Do not loosen screw too quickly or too far.

2. SLOWLY loosen bleed screw (A) in right hand reel lift cylinder.
3. Start engine and activate reel lift control in cab. Left hand cylinder will reach full extension first, then oil will pass to right hand cylinder.
4. Continue to activate reel lift until oil comes out around bleed screw.
5. Tighten bleed screw.

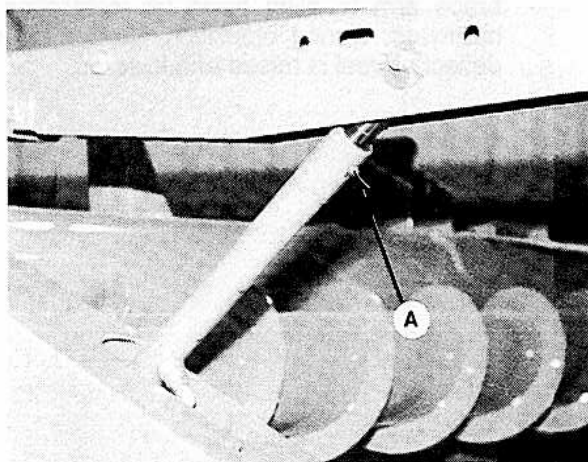

REEL LIFT CYLINDER BLEED SCREW



## UNLOADING & ASSEMBLY

### PREPARE HEADER AND TRACTOR FOR HAY CONDITIONER

1. Install conditioner stop rod (A) through right header leg as shown. Secure with 3/8 x 3/4 carriage bolt and flange nut.

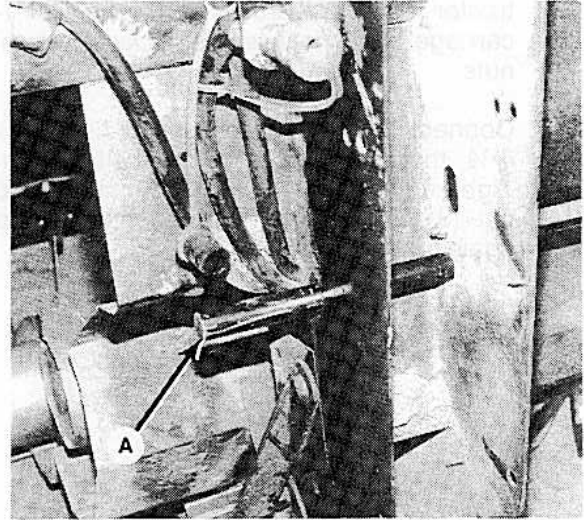

INSTALL CONDITIONER STOP ROD

2. Install drive pulley on header drive shaft at keyway near left leg. When conditioner is attached, install belt and align pulleys, then tighten three bushing bolts (G) to secure the pulley position.

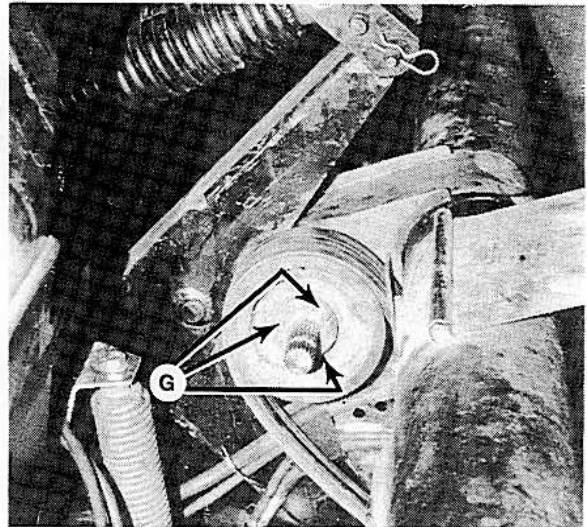

INSTALL DRIVE PULLEY



## UNLOADING & ASSEMBLY

### PREPARE HEADER AND TRACTOR FOR HAY CONDITIONER (continued)

3. Attach conditioner float spring support (H) to tractor left floorboard using three  $1/2 \times 1-1/4$  carriage bolts, flatwashers, lockwashers and nuts.

Connect float spring to support using  $5/8 \times 4-1/2$  thread full length hex bolt and nut. Tighten to attain a  $1/4$  inch (6 mm) gap from nut (J) to support (H) when nut is locked against spring insert.

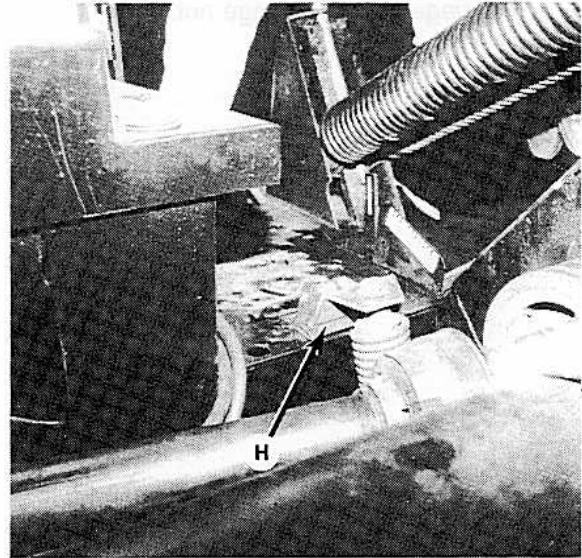
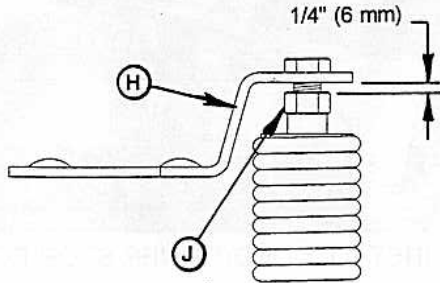

ATTACH FLOAT SPRING & SUPPORT

4. Attach right chain support to tractor frame using one  $1/2 \times 1-1/4$  hex bolt, flatwasher, lockwasher and nut at position (K) and one  $1/2 \times 1-1/4$  hex bolt, lockwasher and nut at position (L).

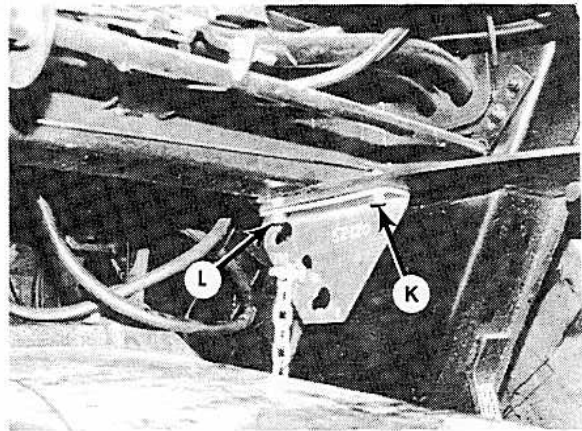

ATTACH R/H CHAIN SUPPORT

## UNLOADING & ASSEMBLY

### ASSEMBLE AND ATTACH HAY CONDITIONER FORMING SHIELDS AND DEFLECTOR FINS

1. Insert threaded rod of side deflector (K) through hole at front corner of top shield.

**IMPORTANT:** Do not confuse left and right side deflectors. The rod must be positioned to the inside of the forming shield assembly.

2. Install two 5/8 hex nuts (L) and (M) on threaded rod.
3. Tighten nut (L) to 100 ft.lbs. (135 N-m).
4. Hold nut (L) with a wrench and tighten nut (M) securely against nut (L).

5. Install deflector fins (C) in holes 2 & 4 on each side of forming shield center line. Position fins approximately parallel to side deflectors and tighten bolt securely.

6. Disassemble spacer (A) and hardware from one side of forming shield assembly.

**NOTE:** For 9030 Bi-Directional Tractor only, move spacer (A) and hardware to top mounting hole, both sides.

7. Mount the "still assembled" side by inserting the spacer into bracket (B) on rear of hay conditioner frame.
8. Position the disassembled side at frame bracket and connect by reassembling spacer and hardware.
9. Attach rear supports to forming shield assembly, at the first bolt (P) from each end as shown.
10. Attach top bracket of rear support to front hole (H) of the two provided in tractor floorboard, each side.  
**NOTE:** If tractor floorboard has only one hole per side for mounting rear support, see "Rear Support Mounting Holes: Pre '95 Tractors" on following page.

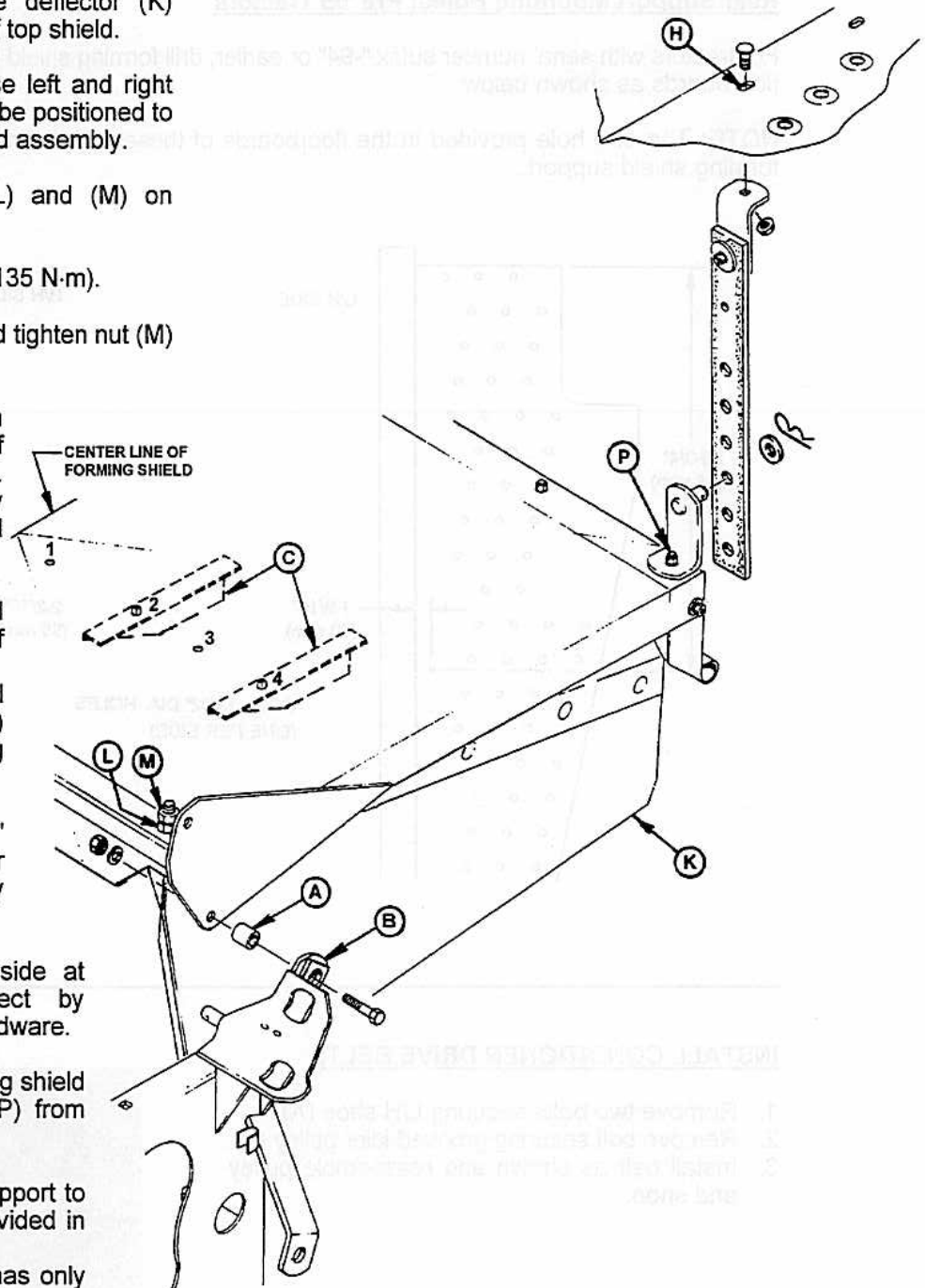

### ATTACH FORMING SHIELDS

## UNLOADING & ASSEMBLY

### ATTACH HAY CONDITIONER FORMING SHIELDS (continued)

#### Rear Support Mounting Holes: Pre '95 Tractors

For tractors with serial number suffix "-94" or earlier, drill forming shield rear support mounting holes in tractor floorboards as shown below.

**NOTE:** The one hole provided in the floorboards of these units is improperly positioned for use with this forming shield support.

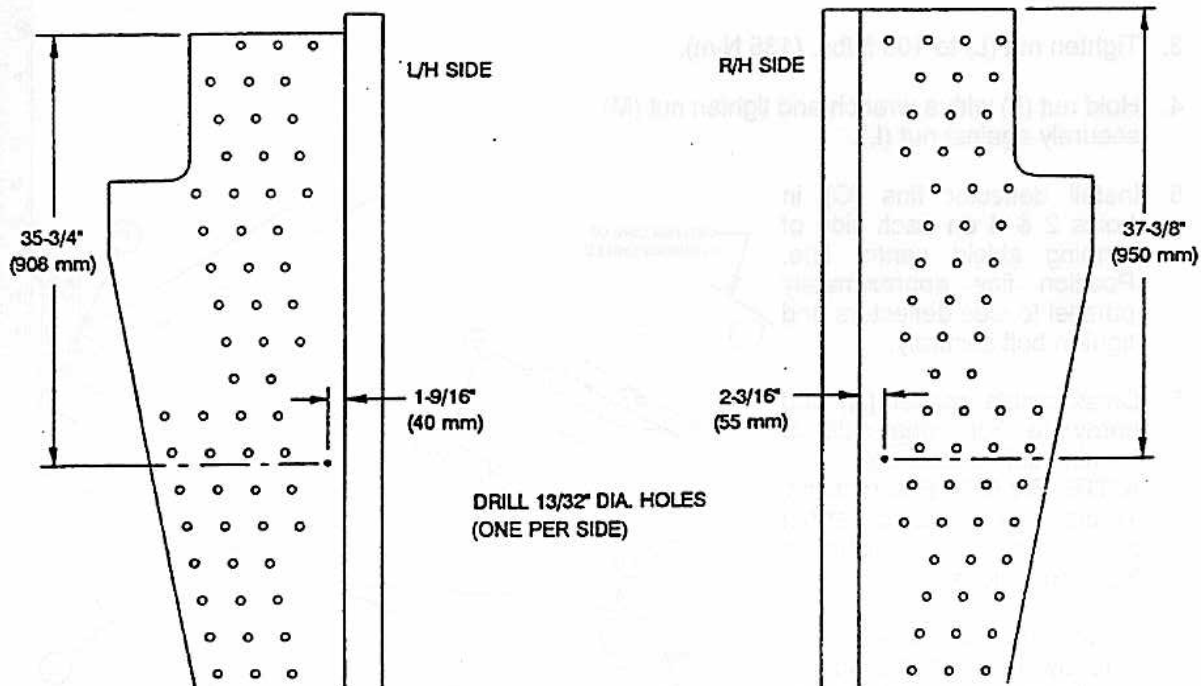

### INSTALL CONDITIONER DRIVE BELTS

1. Remove two bolts securing L/H shoe (A).
2. Remove bolt securing grooved idler pulley (B).
3. Install belt as shown and reassemble pulley and shoe.

### ADJUSTMENTS AND CHECKS

Perform the final checks and adjustments as listed on the "Pre-Delivery Checklist" (yellow insert) to ensure the machine is field-ready. Use the Operator's Manual for directions.

**IMPORTANT:** To avoid machine damage, check that no shipping dunnage has fallen down between augers and feed pans.

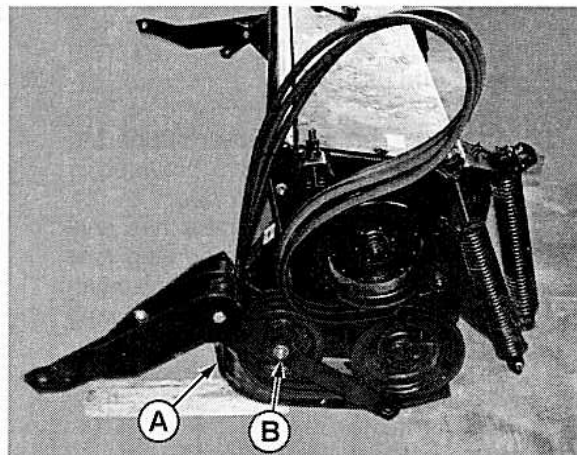

INSTALL CONDITIONER DRIVE BELTS

# INDEX

A	PAGE
Assembly .....	68
Attachments .....	65
Auger Drive Chains Lubrication .....	53
Auger Drive Chains Tension .....	53
Auger Extensions .....	66
Auger Removal .....	52
Auger Speed .....	28
Auger - Upper Cross (Option) .....	29

B	PAGE
Bearing Installation .....	40
Break-In Period .....	17

C	PAGE
Capacity, Wobble Box Lubricant .....	40
Chemical Drying Agents .....	35
Climate and Topography Effects .....	34
Cutting Height .....	22

F	PAGE
Forming Rods .....	29

G	PAGE
Greasing the Header and Hay Conditioner .	41
Ground Speed .....	23
Guards, sickle .....	46

H	PAGE
Hay Conditioner: Attaching .....	13
Hay Conditioner: Detaching .....	15
Hay Conditioner: Drive Chains Lubrication .	54
Hay Conditioner: Drive Chains Tension ...	54
Hay Conditioner: Forming Shields .....	33
Hay Conditioner: Float .....	32
Hay Conditioner: Ground Clearance .....	31
Hay Conditioner: Roll Intermesh .....	30
Hay Conditioner: Roll Tension Springs ....	30
Hay Conditioner: Roll Timing .....	54
Haying Tips .....	34
Header Angle .....	28
Header Controls .....	20
Header Flotation .....	28
Header Lift Cylinder Stops .....	20
Hydraulic Hoses and Lines .....	53
Hydraulic System Safety .....	53

L	PAGE
Lifting from Working Position .....	37
Lubricants, recommended .....	40

M	PAGE
Maintenance Record .....	57
Maintenance Schedule .....	56

O	PAGE
Operating Variables .....	21
Optional Equipment .....	65
Owner/Operator Responsibility .....	12

P	PAGE
Pick-Up Reel Steel Finger (Option) .....	66
Pre-Starting Checks - Annual .....	18
Pre-Starting Checks - Daily .....	19

R	PAGE
Raking and Tedding .....	35
Reel Centering .....	50
Reel Clearance to Cutterbar .....	51
Reel Drive Chain Lubrication .....	51
Reel Drive Chain Tension .....	51
Reel Finger Pitch .....	26
Reel Finger Replacement .....	50
Reel Height .....	24
Reel Position - Fore and Aft .....	25
Reel Props .....	20
Reel Speed .....	24
Roll Wrench - Use and Storage .....	36

S	PAGE
Safety - Alert Symbol .....	5
- General Farm .....	7
- Header Lift Cylinder Stops .....	20
- Hydraulic System .....	53
- Operate Correctly .....	19
- Pre-Starting Checks: Annual .....	18
- Pre-Starting Checks: Daily .....	19
- Reel Props .....	20
- Service Procedures .....	39
- Signal Words .....	5
- Signs .....	6
- Storage Procedure .....	38
- Your Responsibilities .....	12

# INDEX

## S (Cont'd.)

	PAGE
Serial Number Locations.....	4
Service Procedures .....	39
Sickle Drive Belts Tension: Double.....	48
Sickle Drive Belt Tension: Single.....	48
Sickle Guards and Hold-Downs.....	46
Sickle Head Needle Bearing Installation.....	45
Sickle Lubrication.....	44
Sickle Removal & Installation.....	44
Sickle Sections.....	44
Sickle Speed, Changing: Double .....	47
Sickle Timing: Double .....	47
Skid Shoes Adjustment.....	22
Specifications - Header and Conditioner .....	9
- Torque Values.....	10
Storage Procedure.....	38
Stripper Bars .....	52
Stub Guard Conversion Kit.....	66

## T

Topsoil Moisture.....	34
Torque Specifications .....	10
Transporting the Header.....	37
Troubleshooting .....	58

## U

Unloading the Header.....	67
Unplugging the Header or Conditioner .....	36

## W

Windrow Characteristics: Grain .....	35
Windrow Characteristics: Hay.....	35
Windrow Forming Shields.....	33
Wobble Box Maintenance.....	49



## 942 Multi-Crop Header Pre-Delivery Checklist

Perform these checks and adjustments prior to delivery to your customer. See the Operator's Manual for adjustment details.



**CAUTION:** Carefully follow the instructions given. Be alert for safety related messages which bring your attention to hazards and unsafe practices.

**HEADER: Serial Number** \_\_\_\_\_

- Check for shipping damage or missing parts. Be sure all shipping dunnage is removed.
- Bleed left reel lift cylinder before installing reel finger pitch adjustment bolts.
- Adjust reel fore-aft position in eighth hole from front. **IMPORTANT:** To prevent damage from contact with divider rods, do not operate reel forward of sixth hole position.
- Adjust reel finger pitch to suit crop conditions.
- Adjust reel clearance from cutterbar and augers.
- Check sickle drive belt(s) tension.
- Check auger stripper bar clearance.
- Check header flotation. (75 to 100 lbs. [335 to 445 N])
- Check that header is level.
- Grease all bearings and driveline.
- Check wobble box(es) lube level.
- Attach forming rods (if no hay conditioner).
- Check skid shoes are evenly adjusted.
- Run machine for 15 minutes, STOP ENGINE and check drives for belt/idler alignment and heated bearings. Check sickle sections for discolouration caused by misalignment of components.
- Check hydraulic hose and wiring harness routing, ensuring adequate clearance with header up or down.
- Check lights are functional.

**HAY CONDITIONER: Serial Number** \_\_\_\_\_

- Grease all bearings.
- Align conditioner drive pulley on header drive shaft.
- Adjust forming shields to position suitable for conditions.
- Check conditioner flotation.

Date Checked: \_\_\_\_\_

Checked by: \_\_\_\_\_





# MacDon

*The Quiet Leader*